

**Climar**  
L I G H T I N G

we create  
the light of  
tomorrow

ARCHITECTURAL TECHNICAL OUTDOOR

[climarlighting.com](http://climarlighting.com)



we **create** the light of tomorrow



follow us



# CLIMAR LIGHTING

we **create** the light  
of tomorrow

A **Climar Lighting** fabrica e fornece iluminação **fiável, eficiente** e de **alta qualidade** desde **1977**.

Somos especialistas na **conceção** e **fabrico** de soluções de iluminação **arquitetural, decorativa** e **técnica**, desenvolvidas para **responder às necessidades** de projetistas, arquitetos, armazenistas, empreiteiros e utilizadores finais, para a mais **ampla gama de aplicações**.

A **competência técnica** adquirida ao longo de quatro décadas, combinada com a certificação **ISO 9001:2015** do nosso Sistema de Gestão da Qualidade, permite a constante **evolução** da Climar Lighting com vista a afirmar-se como **marca líder de mercado**, numa **busca perseverante** do equilíbrio perfeito entre **Design, Qualidade, Serviço** e **Competitividade**.

Orgulhamo-nos da nossa **obsessiva atenção ao detalhe** e **excelência nos acabamentos**, combinada com a **simplicidade da instalação**.

Embora estas **qualidades** nos diferenciem no mercado, o **nosso trabalho está em constante evolução** e há sempre espaço para **melhoria e refinamento**.

O nosso caminho é guiado pela **dedicação** a esta convicção – garantir o **crescimento contínuo** da Climar Lighting no serviço aos nossos clientes e parceiros.

Um passo dessa evolução é a **WELEX – Especialista no Fabrico de Iluminação Exterior** do **Grupo Climar** – que apresenta uma ampla gama de soluções de iluminação para aplicações em exterior.

Esta é a nossa **filosofia**, a nossa **paixão**, o nosso **compromisso**.



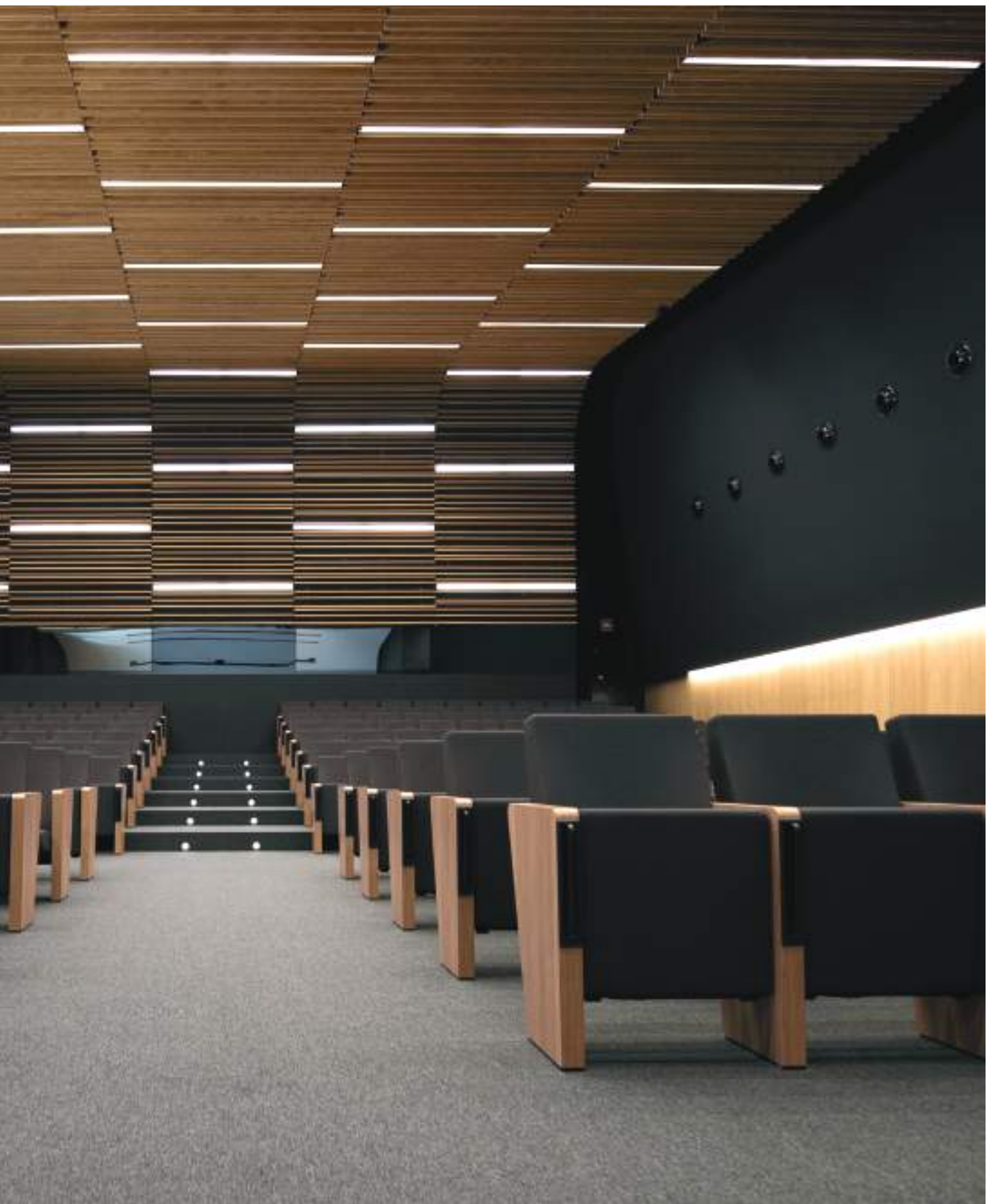

# OUR PHILOSOPHY

## BRAND IDENTITY

### A VISÃO

A Climar Lighting pretende ser uma **referência de excelência** no **mercado nacional** e **internacional** na **conceção**, **desenvolvimento** e **fabricação** de soluções de iluminação arquitetural, decorativa e técnica.

### A MISSÃO

A missão da Climar Lighting é fabricar **luminárias** e **soluções de iluminação** de **elevada qualidade** e **desempenho**, através do desenvolvimento das competências dos seus recursos humanos orientados para a **inovação**, **irreverência** e **design de vanguarda**, assente nos princípios da **diferenciação**, **flexibilidade**, **respeito pelo meio-ambiente** e **responsabilidade social**.

Assim, a Climar Lighting pretende alcançar **elevados níveis de produtividade**, mantendo sempre o **rigor** e a **qualidade**, a **satisfação** dos seus **clientes e parceiros**, bem como fomentar a contínua **qualificação**, **conforto** e **motivação** dos seus **colaboradores**.





## A NOSSA EMPRESA

Desde **1977** enquanto **fabricantes de iluminação**, sempre acreditámos e procurámos **melhorar** com vista a proporcionar **diferentes entendimentos de luz**.

Situada em **Águeda - Portugal** investimos continuamente em **recursos humanos** (150 colaboradores) e em **infraestruturas**.

Dispomos de uma área com **28 500 m<sup>2</sup>**, que englobam a **Sede Climar Lighting**, as **áreas de produção e logística**. Com o objetivo de **potenciar a nossa resposta** enquanto profissionais de iluminação, apostamos num espaço dedicado a **I&D** – o **ClimarLAB** – com **1 500 m<sup>2</sup>**. Destinado à divulgação das últimas tendências de mercado, apresentamos um espaço de exposição com **1 000 m<sup>2</sup>** – **Showroom**.

# OUR COMMITMENT POLICIES

## SUSTENTABILIDADE E RESPONSABILIDADE SOCIAL

Como parte do nosso **compromisso** de **indústria responsável**, a Climar Lighting implementa **procedimentos** e **práticas** ambientais de acordo com a norma **EN ISO 14001**.

Cumprimos rigorosas diretrizes para as **condições de trabalho**, **formação** e **gestão**, garantindo a redução do **desperdício industrial** e a **pegada ecológica**.

Acompanhando sempre os novos desenvolvimentos luminotécnicos e os **requisitos** da Diretiva **RoHS 2**, afirmamos que a **preservação** e **responsabilidade ambiental** fazem parte da nossa **filosofia corporativa**, contribuindo para procedimentos de produção mais **conscientes**, **seguros**, **limpos** e **responsáveis**.

Como empresa **familiar consciente**, assumimos a **responsabilidade social** pelos nossos funcionários através de **excelentes condições de trabalho**, elevados padrões de **saúde** e **segurança**, bem como de **lazer** e **formação**. Também estamos comprometidos com o **bem-estar** da nossa **comunidade local**, participando ativamente em inúmeras iniciativas de caráter **social**, **cultural** e **desportivo**.





## 5 ANOS DE GARANTIA

Possuímos um profundo **conhecimento técnico da luz** e do seu impacto em diferentes contextos, proporcionando as melhores soluções de iluminação para as **necessidades específicas** de cada aplicação.

A **inovação** e a **constante pesquisa** de tecnologias de vanguarda fazem parte da solução, onde a **garantia** é continuamente materializada nos nossos produtos, assegurando sempre a **qualidade, fiabilidade e segurança** em cada detalhe construtivo.

Para oferecer aos nossos clientes um **grau elevado de segurança e proteção**, os produtos Climar beneficiam de uma garantia de **cinco anos** de acordo com as condições de garantia em [www.climarlighting.com](http://www.climarlighting.com).

**5** years  
guarantee

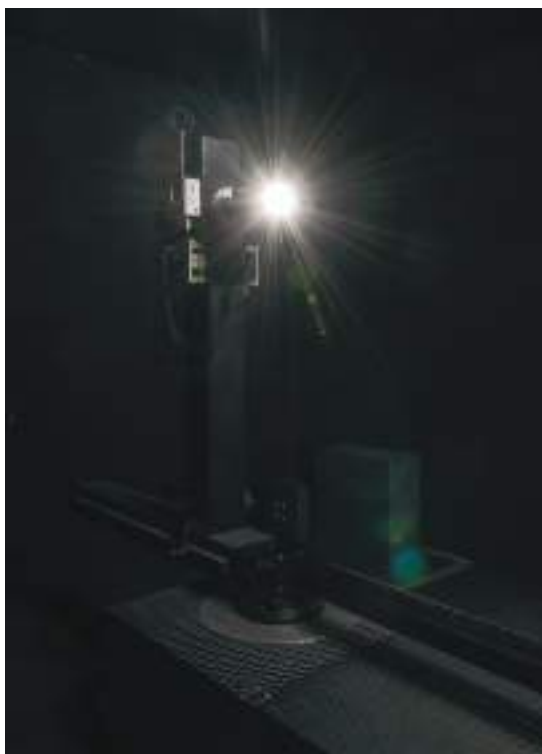
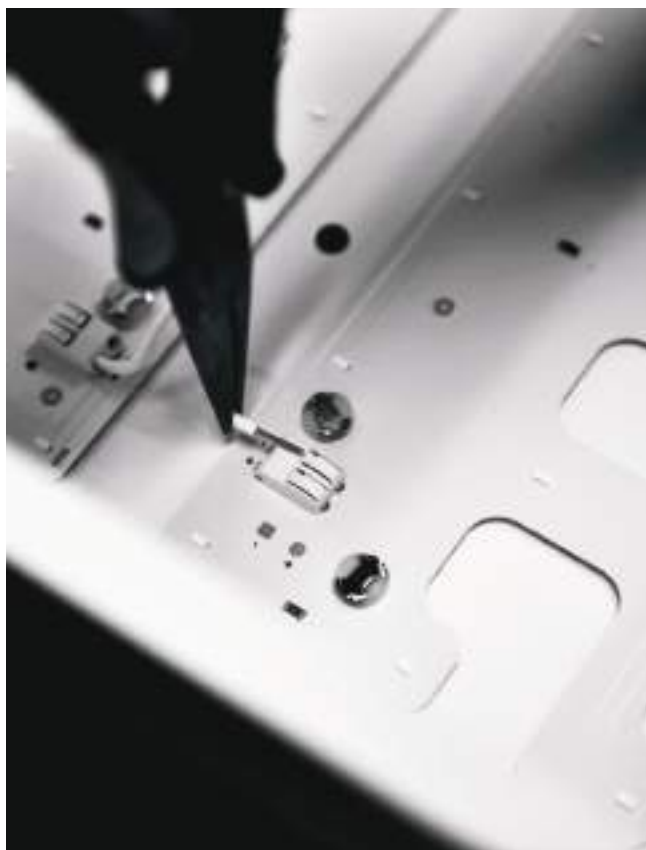

> LABORATÓRIO CLIMAR LIGHTING

## QUALIDADE DA LUZ

Atualmente, produzimos uma vasta gama de produtos de **alta qualidade**, centrados no design com recurso a **diversas técnicas** otimizadas para os diferentes tipos de utilização.

A nossa equipa técnica centra-se no **desenvolvimento dos novos produtos**, investigando as **matérias-primas mais adequadas**, os padrões de qualidade e a implementação de **novas tecnologias** a aplicar nos produtos.

Neste sentido, dedicamo-nos à pesquisa e **desenvolvimento de luminárias LED** que cumprem com as mais **elevadas exigências** em processos rigorosos de **testes técnicos e fotométricos**, nos nossos **próprios laboratórios** ou, quando necessário, com recurso a **laboratórios independentes**.

# CLIMAR LAB R&D DEPARTMENT

## ○ LABORATÓRIO

A **fonte de criatividade** da Climar é apoiada por equipas **multidisciplinares** que aprimoram o **diálogo** e a **comunicação**, permitindo a criação de soluções inovadoras ajustadas às especificidades de cada projeto.

Além da diversidade de soluções de iluminação apresentadas neste catálogo, aceitamos diariamente **pedidos** que **desafiam a nossa própria essência**, em busca de novos conceitos.

**Diferenciamo-nos pela busca incessante de conceitos de iluminação e ambientes inovadores.**



> CLIMAR LAB DEPARTAMENTO I&D, ÁGUEDA - PORTUGAL



## SOLUÇÕES À MEDIDA (BESPOKE)

Desenvolvemos **soluções personalizadas de iluminação** para uma variedade de espaços. Dedicamo-nos à execução de projetos de luz arrojados com base no requisito pela conceção arquitetónica.

A idealização de um **processo bespoke** é sobretudo **interdisciplinar** e **complexa**, envolvendo **diferentes profissionais** da mais **alta qualidade**. Cada projeto é fabricado com base numa **autenticidade** e **originalidade** única, em que cada peça é um **projeto desafiante e fascinante**.

**Comprometemo-nos com o impossível, com a certeza de quem sabe fazer.**

# ANY SPACE IN THE WORLD

## APLICAÇÕES DE REFERÊNCIA

Produzimos **soluções de iluminação versáteis** que desafiam os **limites da criatividade**.

Os nossos produtos distinguem-se pela sua **funcionalidade, estética e tecnologia**. Fatores-chave que nos permitem **transformar e enriquecer** cada espaço com a **solução de iluminação ideal**. Superamos os nossos objetivos através da combinação de **tecnologia de ponta, design intemporal e elevada qualidade de fabricação**.

Fornecemos soluções sofisticadas, que abrangem vários setores de aplicação: **Hotelaria, Residencial, Ensino e Cultura, Comércio e Retalho, Escritórios, Saúde e Bem-Estar, Infraestruturas de Transportes**, entre outros.



> ENSINO E CULTURA



> RESIDENCIAL



> SAÚDE E BEM-ESTAR



> INFRAESTRUTURAS DE TRANSPORTES



> ESCRITÓRIOS



> COMÉRCIO E RETALHO



> HOTELARIA

# ARCHITECTURAL LIGHTING

we **create** distinct **architectural lighting**

A luz assume um papel integrante que contribui para a **personalização** do espaço. Através da solução idealizada atingem-se **aplicações distintas** que atribuem um **destaque singular** à arquitetura.

Ao **efeito estético** e à **presença** da gama **Architectural Lighting**, espera-se também o **cumprimento** das **funções** destinadas, sejam elas: **iluminação singular** de um objeto, **ênfase** de **linhas arquitetónicas**, percepção **natural da luz do dia** (Tunable White), **conforto visual** através do Controlo do Encandeamto (UGR) ou a **diferenciação** através do Design.

Através da solução implementada, o mesmo ambiente pode facilmente adquirir várias **personalidades** através do efeito visual presente: **dramático** com realce de pormenores-chave, **subtil** na implementação de uma iluminação discreta, **pontual** na iluminação de objetos específicos, **amplo** com iluminação de espaços abertos de grande volume, entre outros possíveis efeitos.



## HIGHLIGHTS

BOYA



ASTRA



TUPOLI

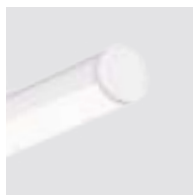

VON



PROFILES



CARDAN





ERUS

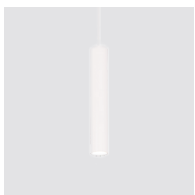

ARES



SILVY



DOURO



BACO



ECLIPSE



# TECHNICAL LIGHTING

we **create** precise **technical lighting**

A **exigência** de ambientes de aplicação de luz técnica, segmentam a escolha à integração de produtos consoante os **objetivos inerentes do espaço**.

Dispomos de uma **vasta diversidade** de produtos, capazes de responder às **condições mais exigentes**, impostas pelo projeto: **Índices de Proteção (IP)**, **Resistência ao Impacto (IK)**, **Índice de Restituição de Cor (CRI)**, **Controlo do Encadeamento (UGR)**, entre outros parâmetros.

A gama **Technical Lighting** apresenta **performances precisas** que transmitem **qualidade** e **fiabilidade**, e que cumprem os **requisitos normativos** destinados às diferentes aplicações.

É esperado um rácio **desempenho/durabilidade** cada vez maior e é tomado como requisito obrigatório o cumprimento exímio dos **objetivos** e **funções** a que se propõem.



## HIGHLIGHTS

ADAAR WD



INDI



ADAS WD



CISTUS



ERGOS



DOWNLIGHTS

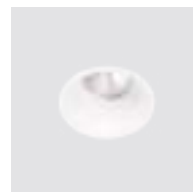





**TRACK & SPOTS**



**RETAIL**



**CLEANROOM**

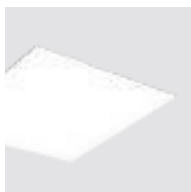

**WATERPROOF**

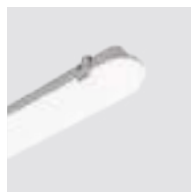

**HIGH-BAY**



**EMERGENCY**



# OUTDOOR LIGHTING

we **create** natural  
**outdoor lighting**

Com a necessidade de proporcionar ao mercado soluções de iluminação para **aplicações em exterior**, em 2017 fundámos a **WELEX – Exterior Lighting**.

O **conceito** para ambientes exteriores centra-se na **otimização da interação** da luz com a arquitetura, de modo a permitir a sua **integração natural** com o meio envolvente.

Oferecemos uma gama de produtos com elevada **durabilidade**, **resistentes** às **condições rigorosas** a que estão expostos, atingindo o **máximo rendimento** com o **mínimo consumo de energia**. Apresentamos **diferentes categorias de produto** que oferecem **diversas soluções**, de acordo com o propósito de aplicação no projeto.

Para um resultado **tecnicamente avançado**, **sustentável** e **customizável**, elegemos um conjunto de critérios fundamentais comuns à conceção dos nossos produtos: **robustez** mecânica, **eficiência** energética, elevado **Índice de Proteção** (IP) e Tratamento dado ao **Acabamento Superficial**, são especificações que garantem a **fiabilidade** do produto.



## HIGHLIGHTS

### IN-GROUND

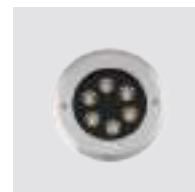



**SPOTLIGHTS**

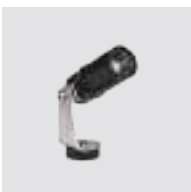

**DOWNLIGHTS**

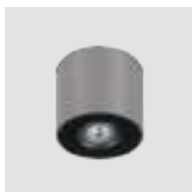

**WALL**



**WALLWASHER**



**BOLLARDS**



**COLUMNS**



# ARCHITECTURAL GENERAL INDEX

## SUSPENDED



**BOYA 90**  
UP

034



**BOYA 90**  
DOWN

036



**BOYA 90**  
UP&DOWN

038



**BOYA 90**  
IN

048



**BOYA 90**  
BULBS IN

056



**BOYA 90**  
BULBS OUT

058



**ASTRA 90**

066



**ASTRA 90 LD/LI**  
Direct / Indirect

074



**ASTRA 150**

070



**ASTRA 150 LD/LI**  
Direct / Indirect

078



**TUPOLI 38**

098



**TUPOLI 55**

102

## SURFACE



**BOYA 90**

044



**ASTRA 90**

082



**ASTRA 150**

086



**TUPOLI 38**

100



**TUPOLI-V 70**

118

## TRIMLESS

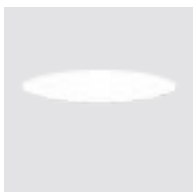

**ASTRA 90**

092

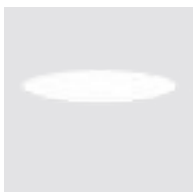

**ASTRA 150**

094

**SUSPENDED**



**BOYA 140**  
OUT

052



**BOYA 150**  
UP&DOWN

040



**TUPOLI 70**

106



**TUPOLI 70**  
I-LIGHT  
Invisible Light

110



**TUPOLI-V 70**

114



**TUPOLI-360 70**

120



**TUPOLI-360 70**  
VERTICAL

124

**FLOOR**



**BOYA 140**

062

# ARCHITECTURAL GENERAL INDEX

## VON, A MODULAR CONCEPT



**VON**  
Suspended

130



**VON**  
Surface

130



**VON**  
Recessed

130



**VON**  
Trimless

130



**VON C-LIGHT**  
Module  
Direct Light

138



**VON I-LIGHT**  
Module  
Invisible Light

140

## PROFILE SYSTEMS - SUSPENDED



**DROP**  
Suspended  
33x75mm

170



**SNAP**  
33x79mm

174



**SNAP LD/LI**  
Direct / Indirect  
33x79mm

178



**ALPHA Track**  
36x76mm

182



**WELINE**  
56x89mm

210



**WELINE LD/LI**  
Direct / Indirect  
56x108mm

222

## PROFILE SYSTEMS - SURFACE



**SNAP**  
33x79mm

186



**SNAP Mini**  
33x37mm

190



**WELINE**  
56x89mm

226



**OMEGA XS**  
86x96mm

264

## PROFILE SYSTEMS - TRIMLESS

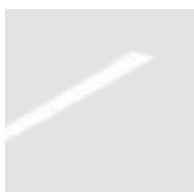

**GAP**  
33x80mm

198

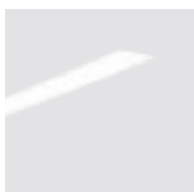

**WELINE**  
55x89mm

244

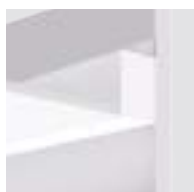

**WELINE Edge**  
55x87mm

248



**OMEGA XS**  
85x96mm

276

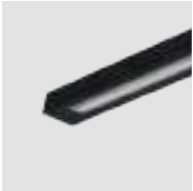

**VON V-LIGHT**  
Module  
Sym / Asym Light  
144



**VON SPOT**  
Module  
148



**VON TUBE**  
Module  
152



**VON GLOBE**  
Module  
156

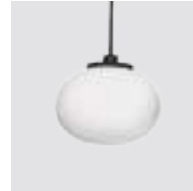

**VON GLOBE S**  
Module  
160



**VON**  
BLIND COVER  
Module  
164



**OMEGA XS**  
86x96mm  
256

**PROFILE SYSTEMS - RECESSED**



**GAP**  
43x78mm  
194



**WELINE**  
72x89mm  
238



**OMEGA XS**  
101x96mm  
270



**OMEGA**  
120x95mm  
282

**PROFILE SYSTEMS - WALL**



**SNAP**  
33x37mm  
204



**SNAP LD/LI**  
Direct / Indirect  
33x79mm  
206



**WELINE**  
56x89mm  
249

# ARCHITECTURAL GENERAL INDEX

## CARDAN



**CARDAN DUO**  
Suspended

288



**CARDAN TETRA**  
Suspended

288



**CARDAN SINGLE**  
Surface

292



**CARDAN DUO**  
Surface

292

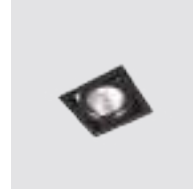

**CARDAN SINGLE**  
Recessed

296



**CARDAN DUO**  
Recessed

296

## ERUS



**ERUS 25**  
Suspended

302

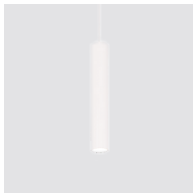

**ERUS 55**  
Suspended

306



**ERUS 90**  
Suspended

312

## ARES



**ARES LI**  
Suspended

316



**ARES LD/LI**  
Suspended

316

## DOURO



**DOURO AP-5**  
Wall

326



**DOURO AP-7**  
Wall

328



**DOURO MC**  
Table Lamp

330



**DOURO PA-2**  
Floor

332

## WALL



**A313**

336



**BERKA**

340



**STRETTO**

344



**NEXUS**

346

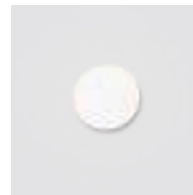

**ECLIPSE**

350



**BACO**

354



**SILVY**



**SILVY**  
Suspended

320



**ODL-010-PA**

358



**ODL-015-PA**

360

# TECHNICAL GENERAL INDEX

## RECESSED



**ADAAR 2WD**

366



**ADAAR 3WD**

366



**ADAAR IP40**

368



**ADAAR IP44**

368



**INDI**

374

## DOWNLIGHTS



**I-SPOT**  
Surface

392



**I-SPOT**  
Orientable  
Surface

394



**I-SPOT RO**  
Surface

396



**I-SPOT SQ**  
Surface

398

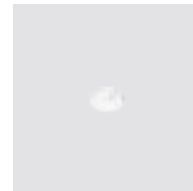

**TALLES 30**  
RO IN  
Recessed

402

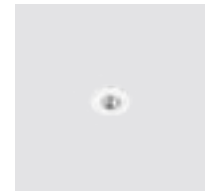

**TALLES 35**  
RO Recessed

404



**TALLES 187**  
RO IP44  
Recessed

442

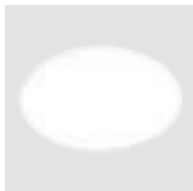

**ATLAS**  
IP44  
Recessed

448



**TALLES 80**  
SQ IN  
Recessed

418

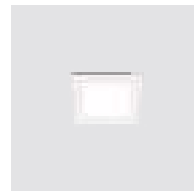

**TALLES 90**  
SQ  
Recessed

428



**TALLES 145**  
SQ IP44  
Recessed

440



**TALLES 200**  
SQ IP44  
Recessed

446

## TRACK & SPOTS



**TRACK PROFILE**  
Surface

464



**TRACK PROFILE**  
Recessed

470



**MIRO 60**  
for Track

476

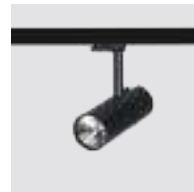

**MIRO 80**  
for Track

480

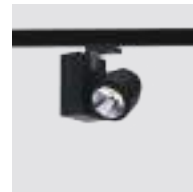

**MIRO 90**  
for Track

484



**MIRO 100**  
for Track

488

**SURFACE**



**ADAS 2WD**

378



**ADAS 3WD**

378



**CISTUS**

382



**ERGOS L**

386



**ERGOS H**

386

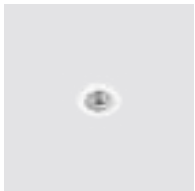

**TALLE 42**  
RO IP65  
Recessed

406

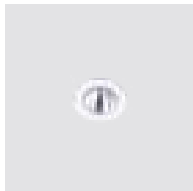

**TALLE 70**  
RO Recessed

408

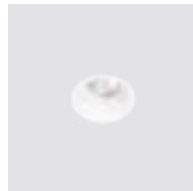

**TALLE 80**  
RO IN Recessed

412

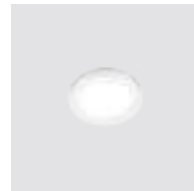

**TALLE 90**  
RO IP65  
Recessed

424



**TALLE 130**  
RO IP44  
Recessed

432



**TALLE 137**  
RO IP44  
Recessed

436

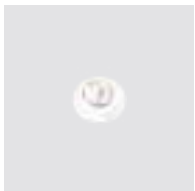

**TALLE 63**  
RO IN  
Trimless

454



**ATLAS**  
RO  
Trimless

458



**ATLAS**  
SQ  
Trimless

460



**MIRO 130**  
for Track

494

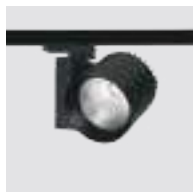

**MIRO 140**  
for Track

498

# TECHNICAL GENERAL INDEX

## RETAIL



**HIPER**  
TRUNKING RAIL  
Continuous Line  
508



**HIPER**  
OPTICAL LENS  
for Trunking  
510



**HIPER**  
FIX PANEL  
for Trunking  
514



**HIPER**  
ORIENT. PANEL  
for Trunking  
516



**HIPER**  
TRACK SPOTS  
for Trunking  
518



**HIPER**  
SUSP. SPOTS  
for Trunking  
528

## CLEANROOM



**ASEPTIC**  
EXTREME  
Surface IP65  
558

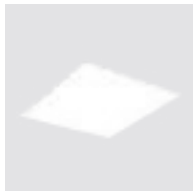

**ASEPTIC**  
EXTREME  
Recessed IP65  
562



**ASEPTIC**  
ADVANC.  
Recessed IP65/54  
566

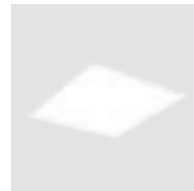

**ASEPTIC**  
REGULAR  
Recessed IP54/20  
570



**ASEPTIC**  
WALK-ON  
Recessed IP65/54  
574

## WATERPROOF



**TUPOLI 70**  
IP65  
Suspended  
580



**TUPOLI 70**  
IP66  
Suspended  
580



**TUPOLI 70**  
IP65  
Surface  
584



**TUPOLI 70**  
IP66  
Surface  
584



**ATE** IP65  
Suspended /  
Surface  
590



**ATE** IP66  
Suspended /  
Surface  
590

## EMERGENCY



**EME TUBE**  
Suspended  
616



**EME TUBE**  
Surface  
618



**EME**  
Surface  
620



**EME**  
Recessed  
622



**EME**  
Wall  
624



**EME SPO**  
Wall  
626



**HIPER**  
EME  
for Trunking  
538



**HIPER IP40**  
Individual  
542



**HIPER IP54**  
Individual  
550

**HIGH-BAY**



**EDBAY RO**  
Suspended  
596



**EDBAY RT**  
Suspended  
598

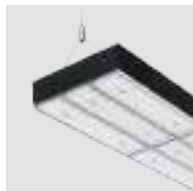

**FACTORY IP54**  
Suspended /  
Surface  
602



**FACTORY IP65**  
Suspended /  
Surface  
606

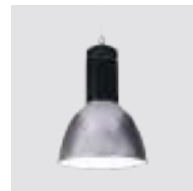

**FOCUS**  
Suspended  
612

# OUTDOOR GENERAL INDEX

## IN-GROUND

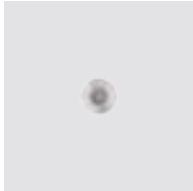

**LANIN 28**

632

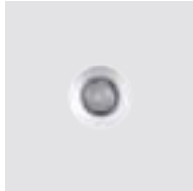

**LANIN 42**

634

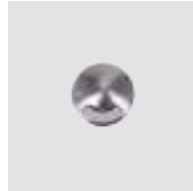

**LANIN 48**

638

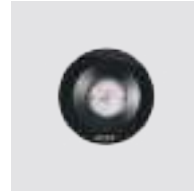

**LANIN 120**

640



**LANIN 135**

642



**LANIN 160**

646

## SPOTLIGHTS

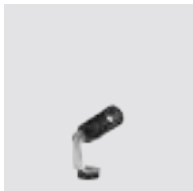

**GARDEN 30**

656

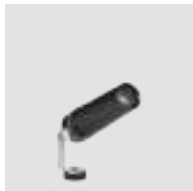

**GARDEN 45**

658

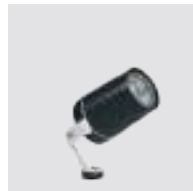

**GARDEN 60**

660



**GARDEN 120**

664

## WALL



**BRICK**  
FLOOD / H / V

680



**ODL-302**

686



**ODL-302 SQ**

688



**DOUBLE MONO**

692

## BOLLARDS



**KAIRO 100**

702



**SQUARE 100**

706



**NAIL**

710



**TYOS**

712



**LANIN 220**

648



**LANIN 260**

650

**DOWNLIGHTS**



**I-SPOT RO**  
IP65

670

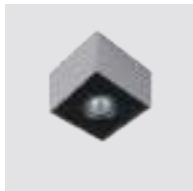

**I-SPOT SQ**  
IP54

674

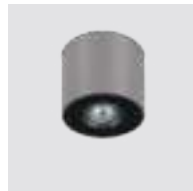

**I-SPOT RO**  
IP54

676

**WALLWASHER**



**NIMIX**

696

**COLUMNS**



**KAIRO**

716

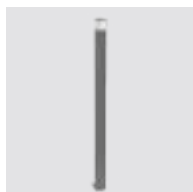

**SQUARE**

718

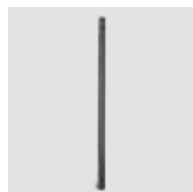

**SQUARE-D 150**

722



**SQUARE-D 220**

724



**TUPOLI**

728







**ARCHITECTURAL**  
LIGHTING

**BOYA**

pag. 032

**ASTRA**

pag. 064

**TUPOLI**

pag. 096

**VON**

pag. 126

**PROFILE SYSTEMS**

pag. 168

**CARDAN**

pag. 286

**ERUS**

pag. 300

**ARES**

pag. 314

**SILVY**

pag. 318

**DOURO**

pag. 324

**WALL**

pag. 334

**BOYA**  
SUSPENDED

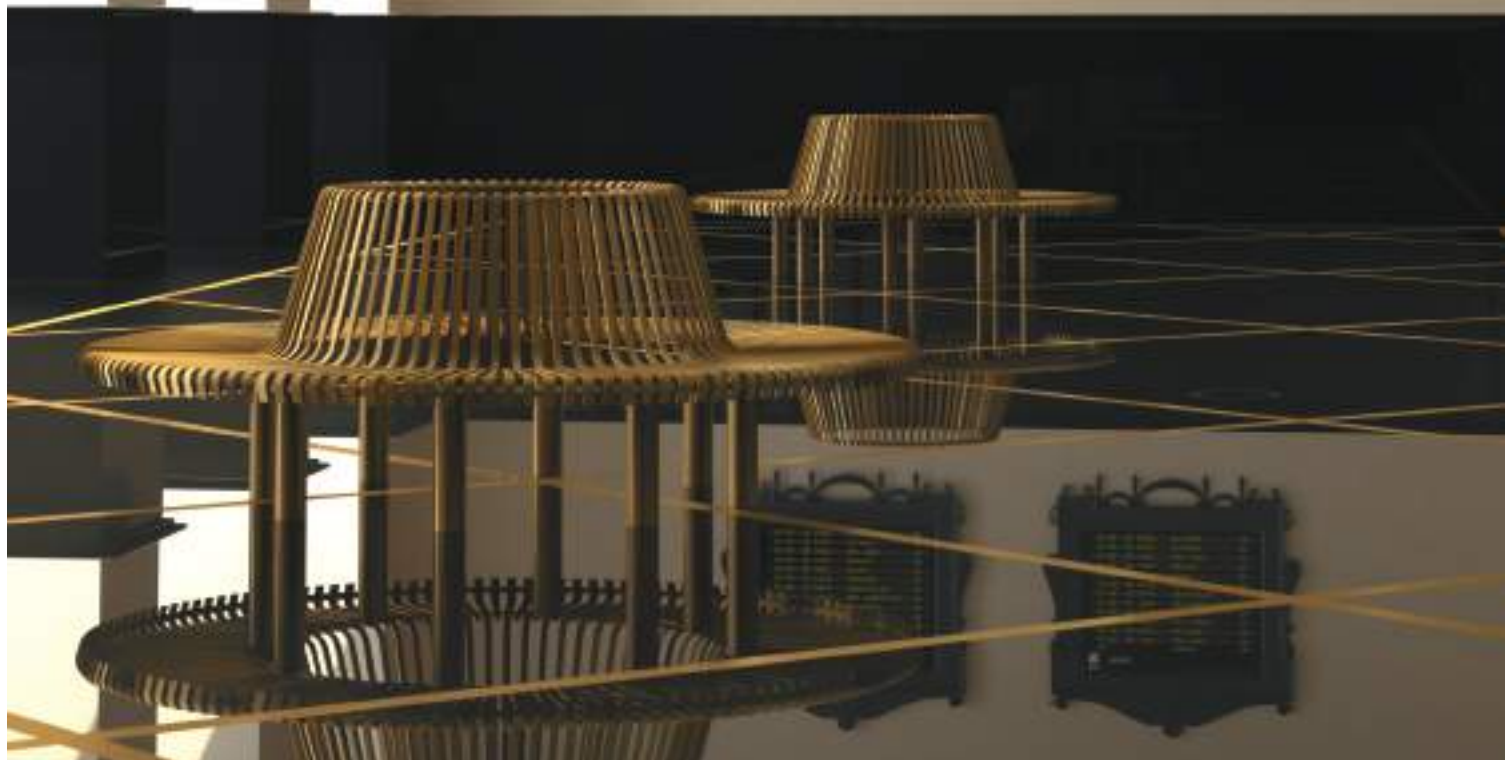



> BOYA 150 UP&DOWN SUSPENDED

# BOYA 90 UP

INDIRECT LIGHT  
SUSPENDED



## PT

- > Luminária de aplicação suspensa com emissão indireta do fluxo luminoso.
- > Suspensão por cabos de aço inox com ajuste rápido da altura.
- > Disponível em três diâmetros standard ou personalizados até 6 metros.
- > Instalação sem necessidade de abertura da luminária.
- > Difusor PMMA Opal para iluminação homogénea, difusa e eficiente.
- > Corpo em alumínio sem emendas visíveis.
- > Acabamento exterior da luminária na cor escolhida pelo cliente, sempre com interior branco para manter a uniformidade da luz e elevado coeficiente de reflexão.

## ES

- > Luminaria para aplicación suspendida con emisión indirecta del flujo luminoso.
- > Suspensión por cables de acero inoxidable con regulación de la altura.
- > Disponible en tres diámetros estándar o personalizados hasta 6 metros.
- > Fácil montaje sin necesidad de abrir la luminaria.
- > Difusor PMMA Opal.
- > Cuerpo en aluminio sin enmiendas visibles.
- > Acabado exterior en el color elegido por el cliente, siempre con interior en blanco para asegurar la uniformidad de la luz y un buen coeficiente de reflexión.

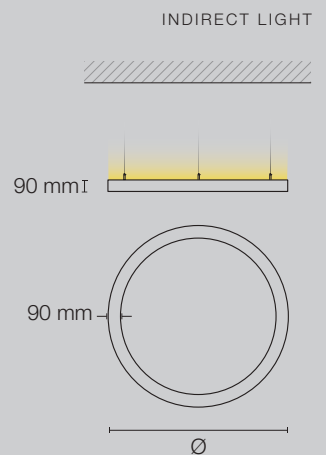

**QUICK INFO****GENERAL**

Suspended  
IP40  
650°C  
Class I  
Ta= -20°C +40°C

**OPTIC**

Opal PMMA

**LED**

Efficacy up to 141 lm/W  
3000 K, 4000 K  
CRI >80  
Lifetime 50 000 H  
L80/B10 @TC=55°C

**ELECTRICAL SYSTEM**

230V/50Hz  
ON/OFF, DALI

**FINISHING**

RAL 9003 Matt White  
RAL 9005 Matt Black

**OPTIONS****LED**

2700 K, 5000 K, 6500 K  
Tunable White, RGB, RGBW  
CRI >90

**ELECTRICAL SYSTEM**

DSI, DIM 1-10V, Phase-cut

**CONTROL SYSTEM**

Bluetooth

**FINISHING**

 Other Colours

**SENSORS**

Motion  
Ambient Light  
Motion & Ambient Light

**BOYA 90 UP SUSPENDED - INDIRECT LIGHT  
OPAL DIFFUSER****MATT WHITE FINISHING**

Ø (mm)	Output (lm)	System (W)	ON/OFF	DALI
<b>3000 K</b>				
1000	1457	28	33.06.40.000722	33.06.40.000731
1400	2004	38	33.06.40.000723	33.06.40.000732
1800	2596	49	33.06.40.000724	33.06.40.000733
<b>4000 K</b>				
1000	1457	26	33.06.40.000728	33.06.40.001053
1400	2004	36	33.06.40.000729	33.06.40.001054
1800	2596	47	33.06.40.000730	33.06.40.001055

**MATT BLACK FINISHING**

Ø (mm)	Output (lm)	System (W)	ON/OFF	DALI
<b>3000 K</b>				
1000	1457	28	33.06.40.000725	33.06.40.000734
1400	2004	38	33.06.40.000726	33.06.40.000735
1800	2596	49	33.06.40.000727	33.06.40.000736
<b>4000 K</b>				
1000	1457	26	33.06.40.000737	33.06.40.001056
1400	2004	36	33.06.40.000738	33.06.40.001057
1800	2596	47	33.06.40.000739	33.06.40.001058

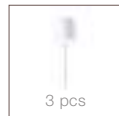
**COMPONENTS****SUSPENSION SYSTEM****S1**

3 pcs  
3 Points Suspension +  
Recessed Ceiling Cup

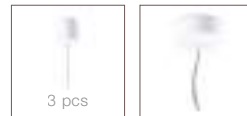
**S2**

3 pcs  
3 Points Suspension +  
Surface Ceiling Cup

**S3**

1 Point Suspension +  
Surface Ceiling Cup

ON/OFF	1 m	3 m	5 m
S1 - White Ø80 mm	35.06.40.001634	35.06.40.002263	35.06.40.002266
S2 - White Ø103x36 mm	35.06.40.001635	35.06.40.002264	35.06.40.002267
S3 - White Ø120x30 mm	35.06.40.001636	35.06.40.002265	35.06.40.002268
DALI	1 m	3 m	5 m
S1 - White Ø80 mm	35.06.40.002283	35.06.40.002284	35.06.40.002285
S2 - White Ø103x36 mm	35.06.40.002286	35.06.40.002287	35.06.40.002288
S3 - White Ø120x30 mm	35.06.40.002289	35.06.40.002290	35.06.40.002291

Opal Diffuser

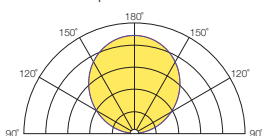

# BOYA 90 DOWN DIRECT LIGHT

## SUSPENDED



### PT

- > Luminária de luz homogénea com emissão direta do fluxo luminoso.
- > De aplicação suspensa por cabos de aço inox com ajuste rápido da altura.
- > Disponível em três diâmetros standard ou personalizados até 6 metros.
- > Instalação sem necessidade de abertura da luminária.
- > Difusor PMMA Opal para iluminação homogénea, difusa e eficiente.
- > Corpo em alumínio sem emendas visíveis.
- > Acabamento exterior da luminária na cor escolhida pelo cliente, sempre com interior branco para manter a uniformidade da luz e elevado coeficiente de reflexão.

### ES

- > Luminaria de luz homogénea con emisión directa del flujo luminoso.
- > De aplicación suspendida por cables de acero inoxidable con regulación de la altura.
- > Disponible en tres diámetros estándar o personalizados hasta 6 metros.
- > Fácil montaje sin necesidad de abrir la luminaria.
- > Difusor PMMA Opal.
- > Cuerpo en aluminio sin enmiendas visibles.
- > Acabado exterior en el color elegido por el cliente, siempre con interior en blanco para asegurar la uniformidad de la luz y un buen coeficiente de reflexión.

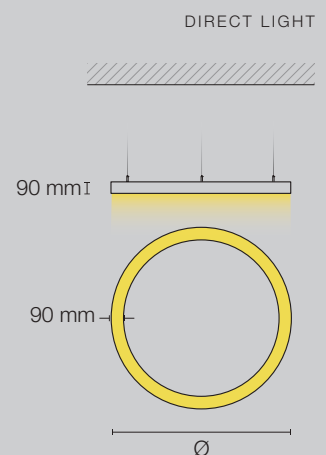

**QUICK INFO****GENERAL**

Suspended  
IP40  
650°C  
Class I  
Ta= -20°C +40°C

**OPTIC**

Opal PMMA

**LED**

Efficacy up to 141 lm/W  
3000 K, 4000 K  
CRI >80  
Lifetime 50 000 H  
L80/B10 @TC=55°C

**ELECTRICAL SYSTEM**

230V/50Hz  
ON/OFF, DALI

**FINISHING**

RAL 9003 Matt White  
RAL 9005 Matt Black

**OPTIONS****LED**

2700 K, 5000 K, 6500 K  
Tunable White, RGB, RGBW  
CRI >90

**ELECTRICAL SYSTEM**

DSI, DIM 1-10V, Phase-cut

**CONTROL SYSTEM**

Bluetooth

**FINISHING**

 Other Colours

**SENSORS**

Motion  
Ambient Light  
Motion & Ambient Light

**BOYA 90 DOWN SUSPENDED - DIRECT LIGHT  
OPAL DIFFUSER****MATT WHITE FINISHING**

Ø (mm)	Output (lm)	System (W)	ON/OFF	DALI
<b>3000 K</b>				
1000	3250	50	33.06.40.000682	33.06.40.000695
1400	4652	72	33.06.40.000683	33.06.40.000696
1800	6053	94	33.06.40.000684	33.06.40.000697
<b>4000 K</b>				
1000	3250	48	33.06.40.000692	33.06.40.000768
1400	4652	68	33.06.40.000693	33.06.40.000769
1800	6053	89	33.06.40.000694	33.06.40.000770

**MATT BLACK FINISHING**

Ø (mm)	Output (lm)	System (W)	ON/OFF	DALI
<b>3000 K</b>				
1000	3250	50	33.06.40.000685	33.06.40.000698
1400	4652	72	33.06.40.000690	33.06.40.000699
1800	6053	94	33.06.40.000691	33.06.40.000700
<b>4000 K</b>				
1000	3250	48	33.06.40.000701	33.06.40.000777
1400	4652	68	33.06.40.000702	33.06.40.000778
1800	6053	89	33.06.40.000703	33.06.40.000779

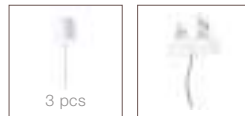
**COMPONENTS****SUSPENSION SYSTEM****S1**

3 pcs  
3 Points Suspension +  
Recessed Ceiling Cup

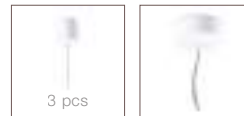
**S2**

3 pcs  
3 Points Suspension +  
Surface Ceiling Cup

**S3**

1 Point Suspension +  
Surface Ceiling Cup

ON/OFF	1 m	3 m	5 m
S1 - White Ø80 mm	35.06.40.001634	35.06.40.002263	35.06.40.002266
S2 - White Ø103x36 mm	35.06.40.001635	35.06.40.002264	35.06.40.002267
S3 - White Ø120x30 mm	35.06.40.001636	35.06.40.002265	35.06.40.002268
DALI	1 m	3 m	5 m
S1 - White Ø80 mm	35.06.40.002283	35.06.40.002284	35.06.40.002285
S2 - White Ø103x36 mm	35.06.40.002286	35.06.40.002287	35.06.40.002288
S3 - White Ø120x30 mm	35.06.40.002289	35.06.40.002290	35.06.40.002291

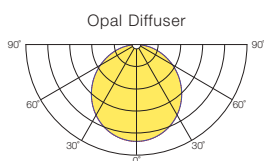

# BOYA 90 UP&DOWN

INDIRECT & DIRECT LIGHT

## SUSPENDED



### PT

- > Luminária de luz homogénea com emissão direta (70%) e indireta (30%) do fluxo.
- > De aplicação suspensa por cabos de aço inox com ajuste rápido da altura.
- > Disponível em três diâmetros standard ou personalizados até 6 metros.
- > Instalação sem necessidade de abertura da luminária.
- > Difusor PMMA Opal para iluminação homogénea, difusa e eficiente.
- > Corpo em alumínio sem emendas visíveis.
- > Acabamento exterior da luminária na cor escolhida pelo cliente, sempre com interior branco para manter a uniformidade da luz e elevado coeficiente de reflexão.

### ES

- > Luminaria de luz homogénea con emisión directa (70%) e indirecta (30%) del flujo.
- > De aplicación suspendida por cables de acero inoxidable con regulación de la altura.
- > Disponible en tres diámetros estándar o personalizados hasta 6 metros.
- > Fácil montaje sin necesidad de abrir la luminaria.
- > Difusor PMMA Opal.
- > Cuerpo en aluminio sin enmiendas visibles.
- > Acabado exterior en el color elegido por el cliente, siempre con interior en blanco para asegurar la uniformidad de la luz y un buen coeficiente de reflexión.

INDIRECT & DIRECT LIGHT

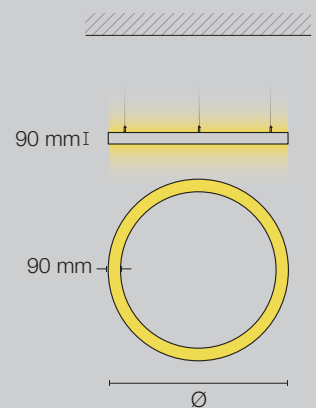



**QUICK INFO****GENERAL**

Suspended  
IP40  
650°C  
Class I  
Ta= -20°C +40°C

**OPTIC**

Opal PMMA

**LED**

Efficacy up to 141 lm/W  
3000 K, 4000 K  
CRI >80  
Lifetime 50 000 H  
L80/B10 @TC=55°C

**ELETRICAL SYSTEM**

230V/50Hz  
ON/OFF, DALI  
Direct / Indirect - Simultaneous Control

**FINISHING**

RAL 9003 Matt White  
RAL 9005 Matt Black

**OPTIONS****LED**

2700 K, 5000 K, 6500 K  
Tunable White, RGB, RGBW  
CRI >90

**ELECTRICAL SYSTEM**

DSI, DIM 1-10V, Phase-cut  
Direct / Indirect - Separate Control

**CONTROL SYSTEM**

Bluetooth

**FINISHING**

 Other Colours

**SENSORS**

Motion  
Ambient Light  
Motion & Ambient Light

**BOYA 90 UP&DOWN SUSPENDED - INDIRECT & DIRECT LIGHT OPAL DIFFUSER****MATT WHITE FINISHING**

Ø (mm)	Output (lm)	System (W)	ON/OFF	DALI
<b>3000 K</b>				
1000	4315	64	33.06.40.000740	33.06.40.000749
1400	6115	90	33.06.40.000741	33.06.40.000750
1800	7948	118	33.06.40.000742	33.06.40.000751
<b>4000 K</b>				
1000	4315	61	33.06.40.000746	33.06.40.001059
1400	6115	87	33.06.40.000747	33.06.40.001060
1800	7948	113	33.06.40.000748	33.06.40.001061

**MATT BLACK FINISHING**

Ø (mm)	Output (lm)	System (W)	ON/OFF	DALI
<b>3000 K</b>				
1000	4315	64	33.06.40.000743	33.06.40.000752
1400	6115	90	33.06.40.000744	33.06.40.000753
1800	7948	118	33.06.40.000745	33.06.40.000754
<b>4000 K</b>				
1000	4315	61	33.06.40.000755	33.06.40.001062
1400	6115	87	33.06.40.000756	33.06.40.001063
1800	7948	113	33.06.40.000757	33.06.40.001064

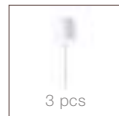
**COMPONENTS****SUSPENSION SYSTEM****S1**

3 pcs  
3 Points Suspension +  
Recessed Ceiling Cup

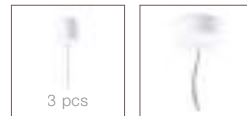
**S2**

3 pcs  
3 Points Suspension +  
Surface Ceiling Cup

**S3**

1 Point Suspension +  
Surface Ceiling Cup

ON/OFF	1 m	3 m	5 m
S1 - White Ø80 mm	35.06.40.001634	35.06.40.002263	35.06.40.002266
S2 - White Ø103x36 mm	35.06.40.001635	35.06.40.002264	35.06.40.002267
S3 - White Ø120x30 mm	35.06.40.001636	35.06.40.002265	35.06.40.002268

DALI	1 m	3 m	5 m
S1 - White Ø80 mm	35.06.40.002283	35.06.40.002284	35.06.40.002285
S2 - White Ø103x36 mm	35.06.40.002286	35.06.40.002287	35.06.40.002288
S3 - White Ø120x30 mm	35.06.40.002289	35.06.40.002290	35.06.40.002291

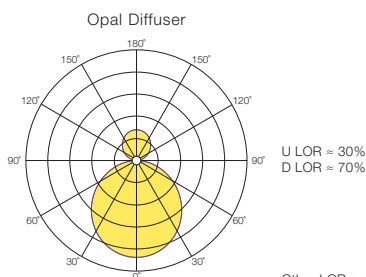

# BOYA 150 UP&DOWN

INDIRECT & DIRECT LIGHT

## SUSPENDED



### PT

- > Luminária de luz homogénea com emissão direta (70%) e indireta (30%) do fluxo.
- > De aplicação suspensa por cabos de aço inox com ajuste rápido da altura.
- > Disponível em quatro diâmetros standard ou personalizados até 6 metros.
- > Instalação sem necessidade de abertura da luminária.
- > Difusor PMMA Opal para iluminação homogénea, difusa e eficiente.
- > Corpo em alumínio sem emendas visíveis.
- > Acabamento exterior da luminária na cor escolhida pelo cliente, sempre com interior branco para manter a uniformidade da luz e elevado coeficiente de reflexão.

### ES

- > Luminaria de luz homogénea con emisión directa (70%) e indirecta (30%) del flujo.
- > De aplicación suspendida por cables de acero inoxidable con regulación de la altura.
- > Disponible en cuatro diámetros estándar o personalizados hasta 6 metros.
- > Fácil montaje sin necesidad de abrir la luminaria.
- > Difusor PMMA Opal.
- > Cuerpo en aluminio sin enmiendas visibles.
- > Acabado exterior en el color elegido por el cliente, siempre con interior en blanco para asegurar la uniformidad de la luz y un buen coeficiente de reflexión.

INDIRECT & DIRECT LIGHT

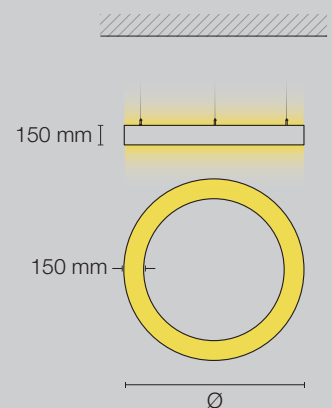

**QUICK INFO****GENERAL**

Suspended  
IP40  
650°C  
Class I  
Ta= -20°C +35°C

**OPTIC**

Opal PMMA

**LED**

Efficacy up to 197 lm/W  
3000 K, 4000 K  
CRI >80  
Lifetime 72 000 H  
L80/B10 @TC=65°C

**ELETRICAL SYSTEM**

230V/50Hz  
ON/OFF, DALI  
Direct / Indirect - Simultaneous Control

**FINISHING**

RAL 9003 Matt White  
RAL 9005 Matt Black

**OPTIONS****LED**

2700 K, 5000 K, 6500 K  
Tunable White, RGB, RGBW  
CRI >90

**ELECTRICAL SYSTEM**

DSI, DIM 1-10V, Phase-cut  
Direct / Indirect - Separate Control

**CONTROL SYSTEM**

Bluetooth

**FINISHING**

 Other Colours

**EMERGENCY**

1 Hour, 3 Hours  
DALI 1 Hour, 3 Hours

**SENSORS**

Motion  
Ambient Light  
Motion & Ambient Light

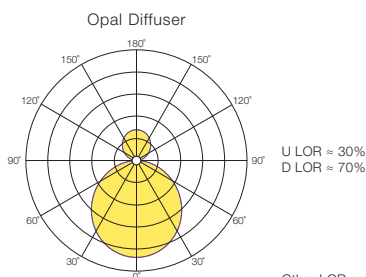
**BOYA 150 UP&DOWN SUSPENDED - INDIRECT & DIRECT LIGHT OPAL DIFFUSER****MATT WHITE FINISHING**

Ø (mm)	Output (lm)	System (W)	ON/OFF	DALI
<b>3000 K</b>				
800	5708	61	33.06.40.001398	33.06.40.001402
1000	7511	78	33.06.40.001399	33.06.40.001403
1200	9180	95	33.06.40.001400	33.06.40.001404
1500	11701	121	33.06.40.001401	33.06.40.001405
<b>4000 K</b>				
800	5976	61	33.06.40.001414	33.06.40.001418
1000	7864	78	33.06.40.001415	33.06.40.001419
1200	9611	95	33.06.40.001416	33.06.40.001420
1500	12250	121	33.06.40.001417	33.06.40.001421

**MATT BLACK FINISHING**

Ø (mm)	Output (lm)	System (W)	ON/OFF	DALI
<b>3000 K</b>				
800	5708	61	33.06.40.001406	33.06.40.001410
1000	7511	78	33.06.40.001407	33.06.40.001411
1200	9180	95	33.06.40.001408	33.06.40.001412
1500	11701	121	33.06.40.001409	33.06.40.001413
<b>4000 K</b>				
800	5976	61	33.06.40.001422	33.06.40.001426
1000	7864	78	33.06.40.001423	33.06.40.001427
1200	9611	95	33.06.40.001424	33.06.40.001428
1500	12250	121	33.06.40.001425	33.06.40.001429

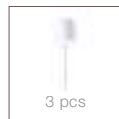
**COMPONENTS****SUSPENSION SYSTEM****S1**

3 pcs  
3 Points Suspension +  
Recessed Ceiling Cup

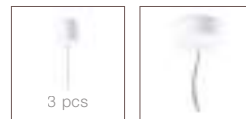
**S2**

3 pcs  
3 Points Suspension +  
Surface Ceiling Cup

**S3**

1 Point Suspension +  
Surface Ceiling Cup

ON/OFF	1 m	3 m	5 m
S1 - White Ø80 mm	35.06.40.001634	35.06.40.002263	35.06.40.002266
S2 - White Ø103x36 mm	35.06.40.001635	35.06.40.002264	35.06.40.002267
S3 - White Ø120x30 mm	35.06.40.001636	35.06.40.002265	35.06.40.002268
DALI	1 m	3 m	5 m
S1 - White Ø80 mm	35.06.40.002283	35.06.40.002284	35.06.40.002285
S2 - White Ø103x36 mm	35.06.40.002286	35.06.40.002287	35.06.40.002288
S3 - White Ø120x30 mm	35.06.40.002289	35.06.40.002290	35.06.40.002291



> BOYA 150 SUSPENDED



> BOYA 90 SURFACE

# BOYA 90 DIRECT LIGHT

## SURFACE



### PT

- > Luminária de luz homogénea com emissão direta do fluxo luminoso.
- > De aplicação saliente.
- > Disponível em três diâmetros standard ou personalizados até 6 metros.
- > Difusor PMMA Opal para iluminação homogénea, difusa e eficiente.
- > Corpo em alumínio sem emendas visíveis.
- > Acabamento exterior da luminária na cor escolhida pelo cliente, sempre com interior branco para manter a uniformidade da luz e elevado coeficiente de reflexão.

### ES

- > Luminaria de luz homogénea con emisión directa del flujo luminoso.
- > De aplicación en superficie.
- > Disponible en tres diámetros estándar o personalizados hasta 6 metros.
- > Difusor PMMA Opal.
- > Cuerpo en aluminio sin enmiendas visibles.
- > Acabado exterior en el color elegido por el cliente, siempre con interior en blanco para asegurar la uniformidad de la luz y un buen coeficiente de reflexión.

**QUICK INFO****GENERAL**

Surface  
IP40  
650°C  
Class I  
Ta= -20°C +40°C

**OPTIC**

Opal PMMA

**LED**

Efficacy up to 141 lm/W  
3000 K, 4000 K  
CRI >80  
Lifetime 50 000 H  
L80/B10 @TC=55°C

**ELECTRICAL SYSTEM**

230V/50Hz  
ON/OFF, DALI

**FINISHING**

RAL 9003 Matt White  
RAL 9005 Matt Black

**OPTIONS****LED**

2700 K, 5000 K, 6500 K  
Tunable White, RGB, RGBW  
CRI >90

**ELECTRICAL SYSTEM**

DSI, DIM 1-10V, Phase-cut

**CONTROL SYSTEM**

Bluetooth

**FINISHING**

 Other Colours

**SENSORS**

Motion  
Ambient Light  
Motion & Ambient Light

**BOYA 90 SURFACE - DIRECT LIGHT****OPAL DIFFUSER****MATT WHITE FINISHING**

Ø (mm)	Output (lm)	System (W)	ON/OFF	DALI
<b>3000 K</b>				
1000	3250	50	33.06.30.000456	33.06.30.000471
1400	4652	72	33.06.30.000457	33.06.30.000472
1800	6053	94	33.06.30.000458	33.06.30.000473
<b>4000 K</b>				
1000	3250	48	33.06.30.000468	33.06.30.000486
1400	4652	68	33.06.30.000469	33.06.30.000487
1800	6053	89	33.06.30.000470	33.06.30.000488

**MATT BLACK FINISHING**

Ø (mm)	Output (lm)	System (W)	ON/OFF	DALI
<b>3000 K</b>				
1000	3250	50	33.06.30.000459	33.06.30.000474
1400	4652	72	33.06.30.000466	33.06.30.000475
1800	6053	94	33.06.30.000467	33.06.30.000476
<b>4000 K</b>				
1000	3250	48	33.06.30.000477	33.06.30.000489
1400	4652	68	33.06.30.000484	33.06.30.000490
1800	6053	89	33.06.30.000485	33.06.30.000491

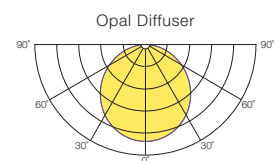
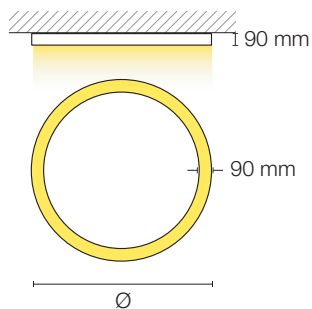

**BOYA 90 IN**  
SUSPENDED





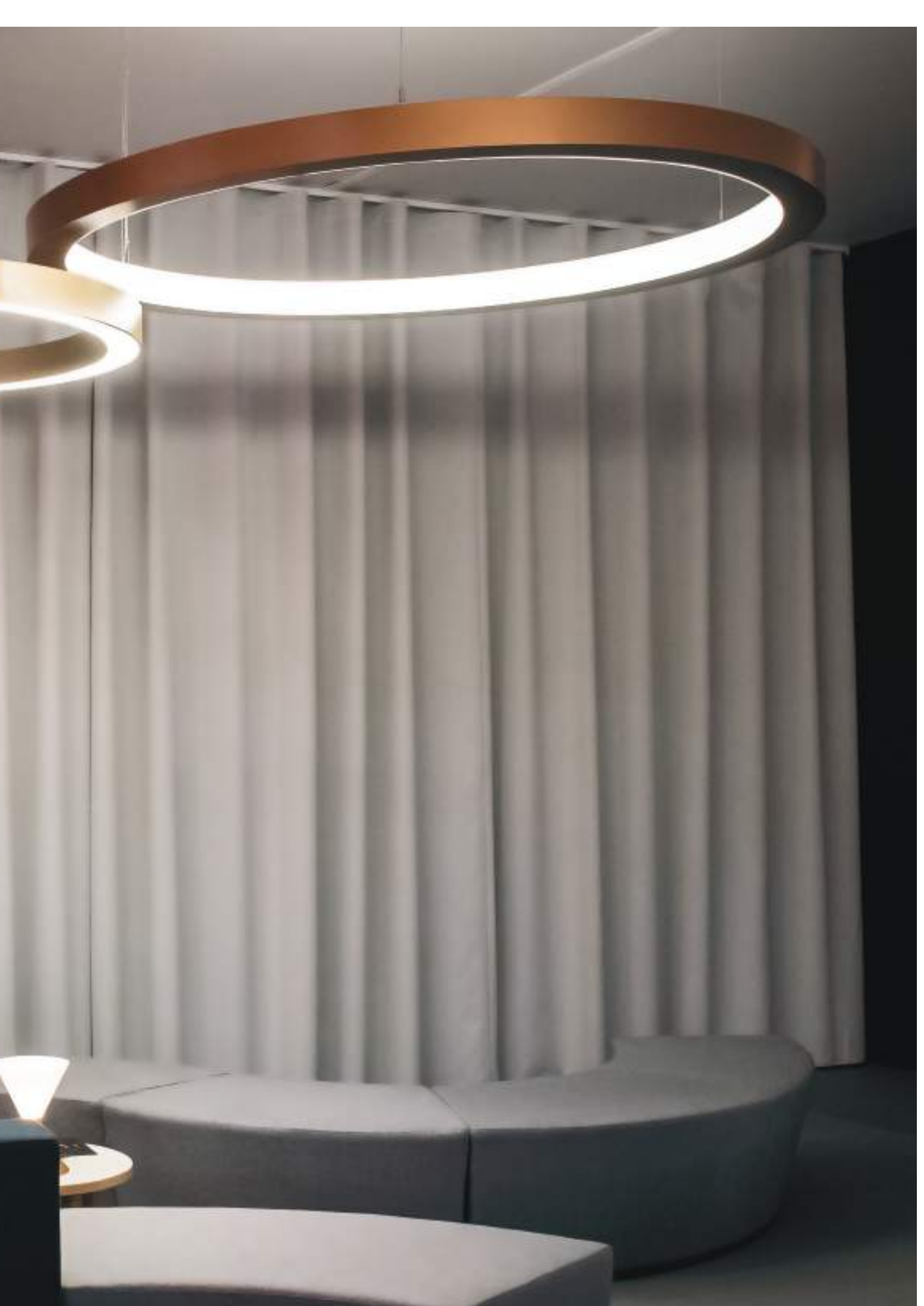

# BOYA 90 IN

## SUSPENDED



### PT

- > Luminária de luz homogénea com distribuição de luz interna.
- > De aplicação suspensa por cabos de aço inox com ajuste rápido da altura.
- > Disponível em três diâmetros standard ou personalizados até 6 metros.
- > Instalação sem necessidade de abertura da luminária.
- > Difusor Policarbonato Opal para iluminação homogénea, difusa e eficiente.
- > Corpo em alumínio sem emendas visíveis.
- > Acabamento exterior da luminária na cor escolhida pelo cliente, sempre com interior branco para manter a uniformidade da luz e elevado coeficiente de reflexão.

### ES

- > Luminaria de luz homogénea con emisión de luz interior.
- > De aplicación suspendida por cables de acero inoxidable con regulación de la altura.
- > Disponible en tres diámetros estándar o personalizados hasta 6 metros.
- > Fácil montaje sin necesidad de abrir la luminaria.
- > Difusor Policarbonato Opal.
- > Cuerpo en aluminio sin enmiendas visibles.
- > Acabado exterior en el color elegido por el cliente, siempre con interior en blanco para asegurar la uniformidad de la luz y un buen coeficiente de reflexión.

**QUICK INFO****GENERAL**

Suspended  
IP40  
850°C  
Class I  
Ta= -20°C +40°C

**OPTIC**

Opal Polycarbonate

**LED**

Efficacy up to 141 lm/W  
3000 K, 4000 K  
CRI >80  
Lifetime 50 000 H  
L80/B10 @TC=55°C

**ELECTRICAL SYSTEM**

230V/50Hz  
ON/OFF, DALI

**FINISHING**

RAL 9003 Matt White  
RAL 9005 Matt Black

**OPTIONS****LED**

2700 K, 5000 K, 6500 K  
Tunable White, RGB, RGBW  
CRI >90

**ELECTRICAL SYSTEM**

DSI, DIM 1-10V, Phase-cut

**CONTROL SYSTEM**

Bluetooth

**FINISHING**

 Other Colours

**SENSORS**

Motion  
Ambient Light  
Motion & Ambient Light

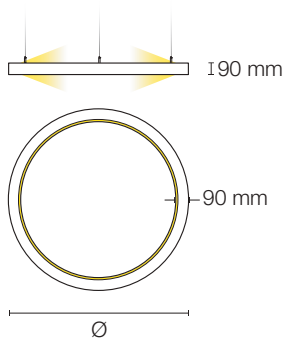
**BOYA 90 IN SUSPENDED  
OPAL DIFFUSER****MATT WHITE FINISHING**

Ø (mm)	Output (lm)	System (W)	ON/OFF	DALI
<b>3000 K</b>				
1000	3304	54	33.06.40.001255	33.06.40.001261
1400	4636	76	33.06.40.001256	33.06.40.001262
1800	5968	97	33.06.40.001257	33.06.40.001263
<b>4000 K</b>				
1000	3304	51	33.06.40.001267	33.06.40.001273
1400	4636	72	33.06.40.001268	33.06.40.001274
1800	5968	92	33.06.40.001269	33.06.40.001275

**MATT BLACK FINISHING**

Ø (mm)	Output (lm)	System (W)	ON/OFF	DALI
<b>3000 K</b>				
1000	3304	54	33.06.40.001258	33.06.40.001264
1400	4636	76	33.06.40.001259	33.06.40.001265
1800	5968	97	33.06.40.001260	33.06.40.001266
<b>4000 K</b>				
1000	3304	51	33.06.40.001270	33.06.40.001276
1400	4636	72	33.06.40.001271	33.06.40.001277
1800	5968	92	33.06.40.001272	33.06.40.001278

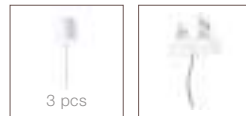
**COMPONENTS****SUSPENSION SYSTEM****S1**

3 Points Suspension +  
Recessed Ceiling Cup

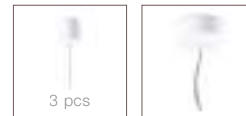
**S2**

3 Points Suspension +  
Surface Ceiling Cup

**S3**

1 Point Suspension +  
Surface Ceiling Cup

TYPE	1 m	3 m	5 m
S1 - White Ø80 mm	35.06.40.001634	35.06.40.002263	35.06.40.002266
S2 - White Ø350x50 mm	35.06.40.002271	35.06.40.002274	35.06.40.002277
S3 - White Ø350x50 mm	35.06.40.002272	35.06.40.002275	35.06.40.002278

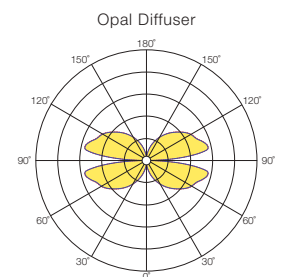

**BOYA 140 OUT**  
SUSPENDED





# BOYA 140 OUT

## SUSPENDED



### PT

- > Luminária com emissão homogénea de luz exterior em todo o perímetro.
- > De aplicação suspensa por cabos de aço inox com ajuste rápido da altura.
- > Instalação sem necessidade de abertura da luminária.
- > Difusor PMMA Opal para iluminação homogénea, difusa e eficiente.
- > Corpo em alumínio sem emendas visíveis.
- > Acabamento exterior da luminária na cor escolhida pelo cliente, sempre com interior branco para manter a uniformidade da luz e elevado coeficiente de reflexão.

### ES

- > Luminaria con emisión homogénea de luz exterior en todo el perímetro.
- > De aplicación suspendida por cables de acero inoxidable con regulación de la altura.
- > Fácil montaje sin necesidad de abrir la luminaria.
- > Difusor PMMA Opal.
- > Cuerpo en aluminio sin enmiendas visibles.
- > Acabado exterior en el color elegido por el cliente, siempre con interior en blanco para asegurar la uniformidad de la luz y un buen coeficiente de reflexión.

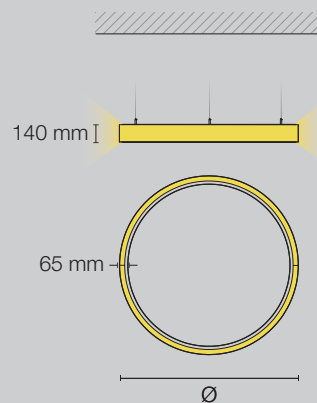

**QUICK INFO****GENERAL**

Suspended  
IP40  
650°C  
Class I  
Ta= -20°C +40°C

**OPTIC**

Opal PMMA

**LED**

Efficacy up to 141 lm/W  
3000 K, 4000 K  
CRI >80  
Lifetime 50 000 H  
L80/B10 @TC=55°C

**ELECTRICAL SYSTEM**

230V/50Hz  
ON/OFF, DALI

**FINISHING**

RAL 9003 Matt White  
RAL 9005 Matt Black

**OPTIONS****LED**

2700 K, 5000 K, 6500 K  
Tunable White, RGB, RGBW  
CRI >90

**ELECTRICAL SYSTEM**

DSI, DIM 1-10V, Phase-cut

**CONTROL SYSTEM**

Bluetooth

**FINISHING**

 Other Colours

**SENSORS**

Motion  
Ambient Light  
Motion & Ambient Light

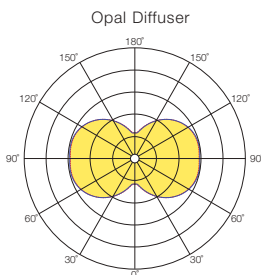
**BOYA 140 OUT SUSPENDED  
OPAL DIFFUSER****MATT WHITE FINISHING**

Ø (mm)	Output (lm)	System (W)	ON/OFF	DALI
<b>3000 K</b>				
1000	4652	46	33.06.40.001279	33.06.40.001285
1400	6766	67	33.06.40.001280	33.06.40.001286
1800	8880	89	33.06.40.001281	33.06.40.001287
2500	18150	195	33.06.40.001319	33.06.40.001321
<b>4000 K</b>				
1000	4652	46	33.06.40.001291	33.06.40.001297
1400	6766	67	33.06.40.001292	33.06.40.001298
1800	8880	89	33.06.40.001293	33.06.40.001299
2500	18150	185	33.06.40.001323	33.06.40.001325

**MATT BLACK FINISHING**

Ø (mm)	Output (lm)	System (W)	ON/OFF	DALI
<b>3000 K</b>				
1000	4652	46	33.06.40.001282	33.06.40.001288
1400	6766	67	33.06.40.001283	33.06.40.001289
1800	8880	89	33.06.40.001284	33.06.40.001290
2500	18150	195	33.06.40.001320	33.06.40.001322
<b>4000 K</b>				
1000	4652	46	33.06.40.001294	33.06.40.001300
1400	6766	67	33.06.40.001295	33.06.40.001301
1800	8880	89	33.06.40.001296	33.06.40.001302
2500	18150	185	33.06.40.001324	33.06.40.001326

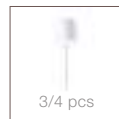
**COMPONENTS****SUSPENSION SYSTEM****S1**

3/4 pcs

3/4 Points Suspension +  
Recessed Ceiling Cup

**S2**

3/4 pcs

3/4 Points Suspension +  
Surface Ceiling Cup

**S3**

1 Point Suspension +  
Surface Ceiling Cup

**BOYA - Ø1000 / Ø1400 / Ø1800**

**3 Points Suspension****1m****3m****5m**

S1 - White Ø80 mm	35.06.40.001634	35.06.40.002263	35.06.40.002266
S2 - White Ø350x50 mm	35.06.40.002271	35.06.40.002274	35.06.40.002277
S3 - White Ø350x50 mm	35.06.40.002272	35.06.40.002275	35.06.40.002278

**BOYA - Ø2500**

**4 Points Suspension****1m****3m****5m**

S1 - White Ø80 mm	35.06.40.003015	35.06.40.003017	35.06.40.003019
S2 - White Ø350x50 mm	35.06.40.003016	35.06.40.003018	35.06.40.003020

**BOYA 90 BULBS**  
SUSPENDED

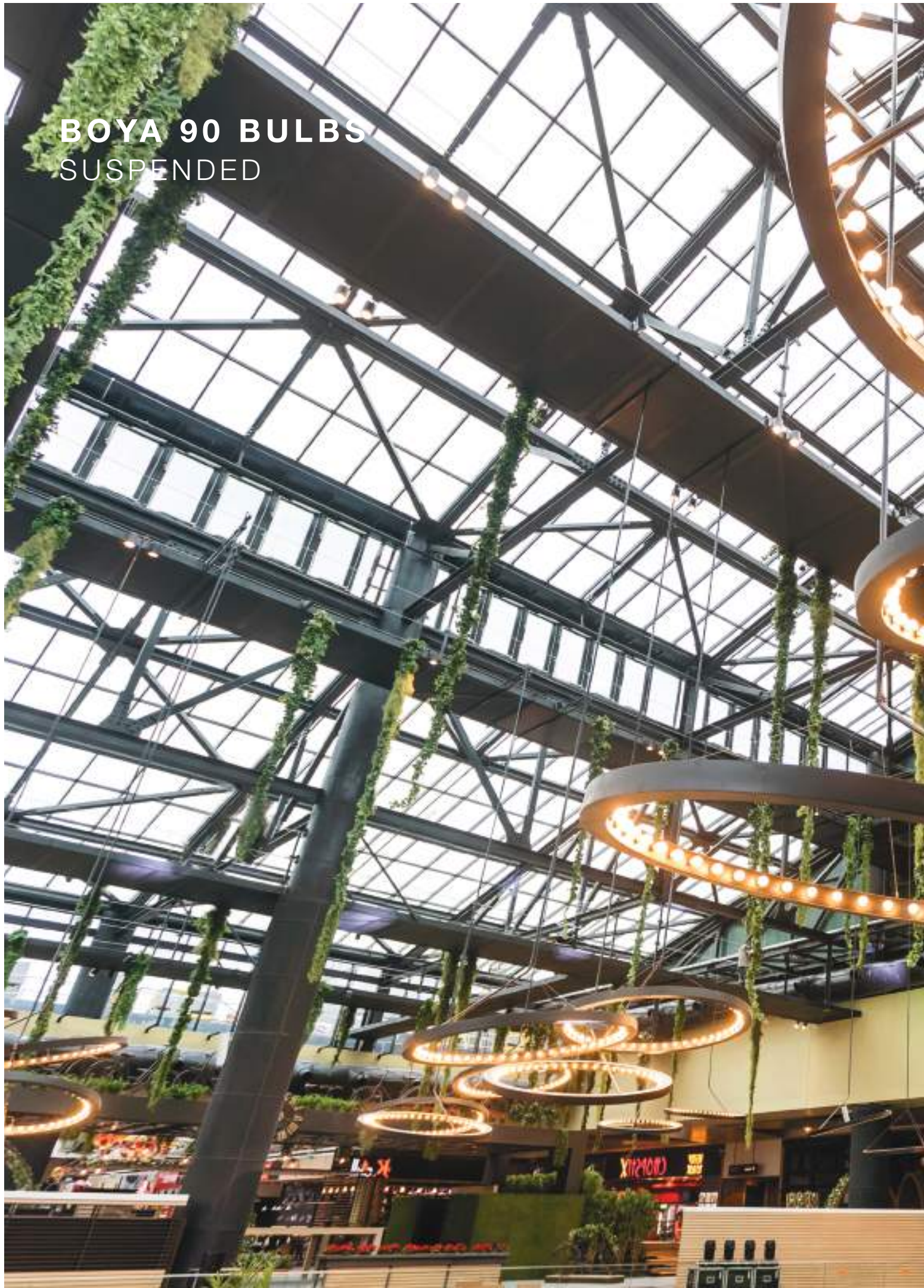





# BOYA 90 BULBS IN SUSPENDED



## PT

- > Luminária decorativa com distribuição de luz interna.
- > De aplicação suspensa por cabos de aço inox com ajuste rápido da altura.
- > Disponível em três diâmetros standard ou personalizados até 6 metros.
- > Instalação sem necessidade de abertura da luminária.
- > Corpo em alumínio sem emendas visíveis.
- > Acabamento standard em preto mate ou branco mate, podendo ter qualquer outra cor a pedido do cliente.

## ES

- > Luminaria decorativa con emisión de luz interior.
- > De aplicación suspendida por cables de acero inoxidable con regulación de la altura.
- > Disponible en tres diámetros estándar o personalizados hasta 6 metros.
- > Fácil montaje sin necesidad de abrir la luminaria.
- > Cuerpo en aluminio sin enmiendas visibles.
- > Acabado estándar en negro mate o blanco mate, pudiendo tener cualquier otro color bajo pedido.

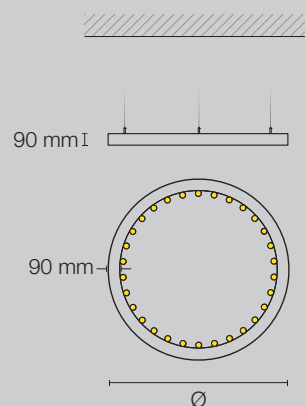

**QUICK INFO****GENERAL**

Suspended  
IP20  
960°C  
Class I  
Ta= -20°C +40°C

**LAMP - NOT INCLUDED**

E14 LED

**ELECTRICAL SYSTEM**

230V/50Hz  
ON/OFF

**FINISHING**

RAL 9003 Matt White  
RAL 9005 Matt Black

**OPTIONS****FINISHING**

 Other Colours

**SENSORS**

Motion

**BOYA 90 BULBS IN SUSPENDED - LAMP****MATT WHITE FINISHING**

Ø (mm)	LAMP Number	LAMP Power (W)	ON/OFF
<b>E14</b>			
1000	21	max. 50	33.06.40.001386
1400	30	max. 50	33.06.40.001387
1800	39	max. 50	33.06.40.001388

> Lamp not included.

**MATT BLACK FINISHING**

Ø (mm)	LAMP Number	LAMP Power (W)	ON/OFF
<b>E14</b>			
1000	21	max. 50	33.06.40.001389
1400	30	max. 50	33.06.40.001390
1800	39	max. 50	33.06.40.001391

> Lamp not included.

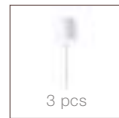
**COMPONENTS****SUSPENSION SYSTEM****S1**

3 pcs

3 Points Suspension +  
Recessed Ceiling Cup

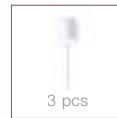
**S2**

3 pcs

3 Points Suspension +  
Surface Ceiling Cup

**S3**

1 Point Suspension +  
Surface Ceiling Cup

ON/OFF	1 m	3 m	5 m
S1 - White Ø80 mm	35.06.40.001634	35.06.40.002263	35.06.40.002266
S2 - White Ø103x36 mm	35.06.40.001635	35.06.40.002264	35.06.40.002267
S3 - White Ø120x30 mm	35.06.40.001636	35.06.40.002265	35.06.40.002268

**RECOMENDED LAMPS**

**OSRAM**  
PARATHOM  
Retrofit  
CLASSIC P  
4W



**PHILIPS**  
CLA  
LEDLuster D  
5W

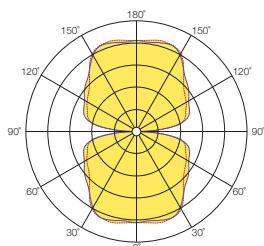

Lamp: 4W LED (E14).

# BOYA 90 BULBS OUT SUSPENDED



## PT

- > Luminária decorativa com distribuição de luz externa.
- > De aplicação suspensa por cabos de aço inox com ajuste rápido da altura.
- > Disponível em três diâmetros standard ou personalizados até 6 metros.
- > Instalação sem necessidade de abertura da luminária.
- > Corpo em alumínio sem emendas visíveis.
- > Acabamento standard em preto mate ou branco mate, podendo ter qualquer outra cor a pedido do cliente.

## ES

- > Luminaria decorativa con emisión de luz exterior.
- > De aplicación suspendida por cables de acero inoxidable con regulación de la altura.
- > Disponible en tres diámetros estándar o personalizados hasta 6 metros.
- > Fácil montaje sin necesidad de abrir la luminaria.
- > Cuerpo en aluminio sin enmiendas visibles.
- > Acabado estándar en negro mate o blanco mate, pudiendo tener cualquier otro color bajo pedido.

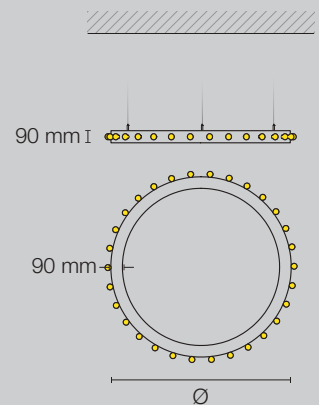

**QUICK INFO****GENERAL**

Suspended  
IP20  
960°C  
Class I  
Ta= -20°C +40°C

**LAMP - NOT INCLUDED**

E14 LED

**ELECTRICAL SYSTEM**

230V/50Hz  
ON/OFF

**FINISHING**

RAL 9003 Matt White  
RAL 9005 Matt Black

**OPTIONS****FINISHING**

 Other Colours

**SENSORS**

Motion

**BOYA 90 BULBS OUT SUSPENDED - LAMP****MATT WHITE FINISHING**

Ø (mm)	LAMP Number	LAMP Power (W)	ON/OFF
<b>E14</b>			
1000	21	max. 50	33.06.40.001392
1400	30	max. 50	33.06.40.001393
1800	39	max. 50	33.06.40.001394

> Lamp not included.

**MATT BLACK FINISHING**

Ø (mm)	LAMP Number	LAMP Power (W)	ON/OFF
<b>E14</b>			
1000	21	max. 50	33.06.40.001395
1400	30	max. 50	33.06.40.001396
1800	39	max. 50	33.06.40.001397

> Lamp not included.

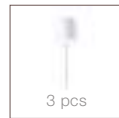
**COMPONENTS****SUSPENSION SYSTEM****S1**

3 pcs

3 Points Suspension +  
Recessed Ceiling Cup

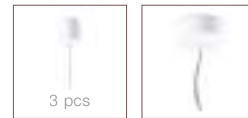
**S2**

3 pcs

3 Points Suspension +  
Surface Ceiling Cup

**S3**

1 Point Suspension +  
Surface Ceiling Cup

ON/OFF	1 m	3 m	5 m
S1 - White Ø80 mm	35.06.40.001634	35.06.40.002263	35.06.40.002266
S2 - White Ø103x36 mm	35.06.40.001635	35.06.40.002264	35.06.40.002267
S3 - White Ø120x30 mm	35.06.40.001636	35.06.40.002265	35.06.40.002268

**RECOMENDED LAMPS**

**OSRAM**  
PARATHOM  
Retrofit  
CLASSIC P  
4W



**PHILIPS**  
CLA  
LEDLuster D  
5W

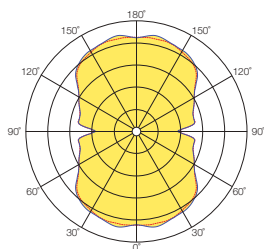

Lamp: 4W LED (E14).



> BOYA 140 FLOOR



> BOYA 140 FLOOR

# BOYA 140

## FLOOR

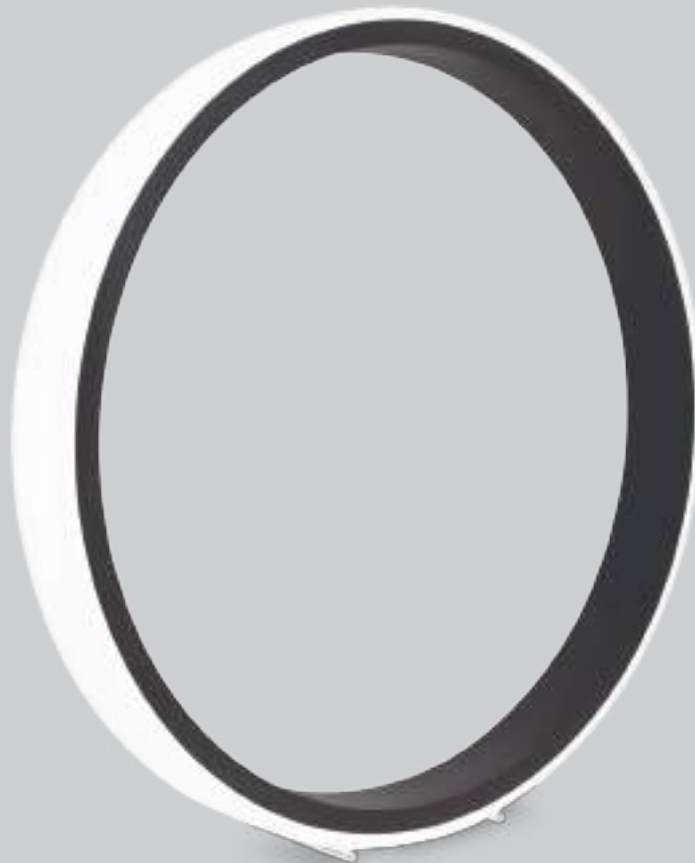

### PT

- > Luminária de chão com emissão homogénea de luz em todo o perímetro exterior.
- > Inclui cabo de alimentação de 2500 mm, ficha Tipo F e caixa externa com botão de pressão para regulação do fluxo luminoso.
- > Difusor PMMA Opal para iluminação homogénea, difusa e eficiente.
- > Corpo em alumínio sem emendas visíveis.
- > Acabamento exterior da luminária na cor escolhida pelo cliente, sempre com interior branco para manter a uniformidade da luz e elevado coeficiente de reflexão.

### ES

- > Lámpara de pie con emisión homogénea de luz en todo el perímetro exterior.
- > Incluye cable de alimentación de 2500 mm, clavija Tipo F y caja externa con botón de presión para regulación del flujo luminoso.
- > Difusor PMMA Opal.
- > Cuerpo en aluminio sin enmiendas visibles.
- > Acabado exterior en el color elegido por el cliente, siempre con interior en blanco para asegurar la uniformidad de la luz y un buen coeficiente de reflexión.



**QUICK INFO****GENERAL**

Floor  
 IP40  
 650°C  
 Class I  
 Ta= -20°C +40°C

**OPTIC**

Opal PMMA

**LED**

Efficacy up to 136 lm/W  
 3000 K, 4000 K  
 CRI >80  
 Lifetime 50 000 H  
 L80/B10 @TC=55°C

**ELECTRICAL SYSTEM**

230V/50Hz  
 DIMMABLE

**FINISHING**

RAL 9003 Matt White  
 RAL 9005 Matt Black

**BOYA 140 FLOOR****OPAL DIFFUSER****MATT WHITE FINISHING**

Ø (mm)	Output (lm)	System (W)	DIMMABLE
<b>3000 K</b>			
1400	6636	67	33.06.40.001119
<b>4000 K</b>			
1400	6636	67	33.06.40.001123

**MATT BLACK FINISHING**

Ø (mm)	Output (lm)	System (W)	DIMMABLE
<b>3000 K</b>			
1400	6636	67	33.06.40.001120
<b>4000 K</b>			
1400	6636	67	33.06.40.001124

**OPTIONS****LED**

2700 K, 5000 K, 6500 K  
 Tunable White, RGB, RGBW  
 CRI >90

**ELECTRICAL SYSTEM**

DSI, DIM 1-10V, Phase-cut

**CONTROL SYSTEM**

Bluetooth

**FINISHING**

 Other Colours

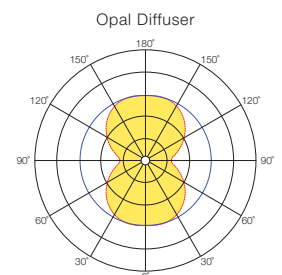
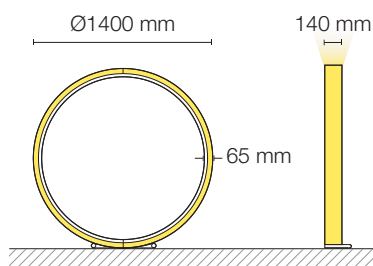

**ASTRA**  
SUSPENDED





# ASTRA 90 DIRECT LIGHT

## SUSPENDED



### PT

- > Luminária de luz homogénea com emissão direta do fluxo luminoso.
- > De aplicação suspensa por cabos de aço inox com ajuste rápido da altura.
- > Disponível em quatro diâmetros standard ou personalizados até 6 metros.
- > Fixação magnética do corpo à base da luminária.
- > Difusor PMMA Microprismático para controlo do encandeamento (UGR <19) ou difusor Policarbonato Opal para luz difusa.
- > Corpo único em alumínio sem parafusos visíveis.
- > Acabamento exterior da luminária na cor escolhida pelo cliente, sempre com interior branco para manter a uniformidade da luz e elevado coeficiente de reflexão.

### ES

- > Luminaria de luz homogénea con emisión directa del flujo luminoso.
- > De aplicación suspendida por cables de acero inoxidable con regulación de la altura.
- > Disponible en cuatro diámetros estándar o personalizados hasta 6 metros.
- > Fijación magnética del cuerpo a la base de la luminaria.
- > Difusor PMMA Microprismático para control del deslumbramiento (UGR <19) o difusor Policarbonato Opal.
- > Cuerpo en aluminio en una sola pieza sin tornillos visibles.
- > Acabado exterior en el color elegido por el cliente, siempre con interior en blanco para asegurar la uniformidad de la luz y un buen coeficiente de reflexión.

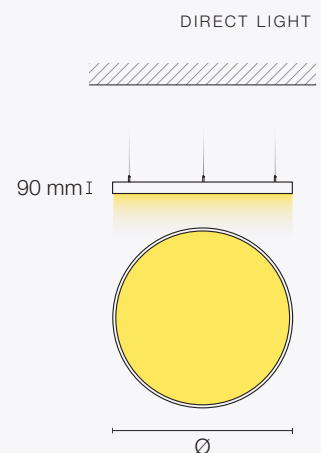

**QUICK INFO**

**GENERAL**

Suspended  
 IP40  
 850°C  
 Class I  
 Ta= -20°C +35°C

**OPTIC**

Opal Polycarbonate

**LED**

Efficacy up to 187 lm/W  
 3000 K, 4000 K  
 CRI >80  
 Lifetime 50 000 H  
 L90/B10 @TC=65°C

**ELETRICAL SYSTEM**

230V/50Hz  
 ON/OFF, DALI

**FINISHING**

RAL 9003 Matt White  
 RAL 9005 Matt Black

**OPTIONS**

**LED**

2700 K, 5000 K, 6500 K  
 Tunable White, RGB, RGBW  
 CRI >90

**ELECTRICAL SYSTEM**

DSI, DIM 1-10V, Phase-cut

**CONTROL SYSTEM**

Bluetooth

**FINISHING**

 Other Colours

**EMERGENCY**

1 Hour, 3 Hours  
 DALI 1 Hour, 3 Hours

**SENSORS**

Motion  
 Ambient Light  
 Motion & Ambient Light

**ASTRA 90 SUSPENDED - DIRECT LIGHT**

**OPAL DIFFUSER**

**MATT WHITE FINISHING**

Ø (mm)	Output (lm)	System (W)	ON/OFF	DALI
<b>3000 K</b>				
400	2020	18	33.06.40.001126	33.06.40.001130
	2818	26	33.06.40.001127	33.06.40.001131
550	3498	30	33.06.40.000528	33.06.40.000600
	5358	47	33.06.40.000529	33.06.40.000601
830	7228	59	33.06.40.000530	33.06.40.000602
	11138	94	33.06.40.000531	33.06.40.000603
1110	12808	107	33.06.40.000532	33.06.40.000604
	19619	172	33.06.40.000533	33.06.40.000605
<b>4000 K</b>				
400	2020	18	33.06.40.001142	33.06.40.001146
	2818	26	33.06.40.001143	33.06.40.001147
550	3498	30	33.06.40.000546	33.06.40.000618
	5358	47	33.06.40.000547	33.06.40.000619
830	7228	59	33.06.40.000548	33.06.40.000620
	11138	94	33.06.40.000549	33.06.40.000621
1110	12808	107	33.06.40.000550	33.06.40.000622
	19619	172	33.06.40.000551	33.06.40.000623

**MATT BLACK FINISHING**

Ø (mm)	Output (lm)	System (W)	ON/OFF	DALI
<b>3000 K</b>				
400	2020	18	33.06.40.001128	33.06.40.001132
	2818	26	33.06.40.001129	33.06.40.001133
550	3498	30	33.06.40.000540	33.06.40.000612
	5358	47	33.06.40.000541	33.06.40.000613
830	7228	59	33.06.40.000542	33.06.40.000614
	11138	94	33.06.40.000543	33.06.40.000615
1110	12808	107	33.06.40.000544	33.06.40.000616
	19619	172	33.06.40.000545	33.06.40.000617
<b>4000 K</b>				
400	2020	18	33.06.40.001144	33.06.40.001148
	2818	26	33.06.40.001145	33.06.40.001149
550	3498	30	33.06.40.000558	33.06.40.000630
	5358	47	33.06.40.000559	33.06.40.000631
830	7228	59	33.06.40.000560	33.06.40.000632
	11138	94	33.06.40.000561	33.06.40.000633
1110	12808	107	33.06.40.000562	33.06.40.000634
	19619	172	33.06.40.000563	33.06.40.000635

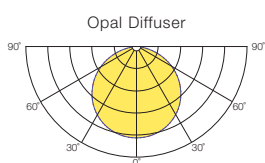

**QUICK INFO**

**GENERAL**

Suspended  
 IP40  
 650°C  
 Class I  
 Ta= -20°C +35°C

**OPTIC**

Micro Prismatic PMMA - UGR <19

**LED**

Efficacy up to 193 lm/W  
 3000 K, 4000 K  
 CRI >80  
 Lifetime 50 000 H  
 L90/B10 @Tc=65°C

**ELETRICAL SYSTEM**

230V/50Hz  
 ON/OFF, DALI

**FINISHING**

RAL 9003 Matt White  
 RAL 9005 Matt Black

**OPTIONS**

**LED**

2700 K, 5000 K, 6500 K  
 Tunable White, RGB, RGBW  
 CRI >90

**ELECTRICAL SYSTEM**

DSI, DIM 1-10V, Phase-cut

**CONTROL SYSTEM**

Bluetooth

**FINISHING**

 Other Colours

**EMERGENCY**

1 Hour, 3 Hours  
 DALI 1 Hour, 3 Hours

**SENSORS**

Motion  
 Ambient Light  
 Motion & Ambient Light

**ASTRA 90 SUSPENDED - DIRECT LIGHT  
 MICRO PRISMATIC DIFFUSER - UGR <19**

**MATT WHITE FINISHING**

Ø (mm)	Output (lm)	System (W)	ON/OFF	DALI
<b>3000 K</b>				
400	2110	18	33.06.40.001134	33.06.40.001138
	2943	26	33.06.40.001135	33.06.40.001139
550	3654	30	33.06.40.000564	33.06.40.000636
	5597	47	33.06.40.000565	33.06.40.000637
830	7467	59	33.06.40.000566	33.06.40.000638
	11476	94	33.06.40.000567	33.06.40.000639
1110	13487	107	33.06.40.000568	33.06.40.000640
	20659	172	33.06.40.000569	33.06.40.000641
<b>4000 K</b>				
400	2110	18	33.06.40.001150	33.06.40.001154
	2943	26	33.06.40.001151	33.06.40.001155
550	3654	30	33.06.40.000582	33.06.40.000654
	5597	47	33.06.40.000583	33.06.40.000655
830	7467	59	33.06.40.000584	33.06.40.000656
	11476	94	33.06.40.000585	33.06.40.000657
1110	13487	107	33.06.40.000586	33.06.40.000658
	20659	172	33.06.40.000587	33.06.40.000659

**MATT BLACK FINISHING**

Ø (mm)	Output (lm)	System (W)	ON/OFF	DALI
<b>3000 K</b>				
400	2110	18	33.06.40.001136	33.06.40.001140
	2943	26	33.06.40.001137	33.06.40.001141
550	3654	30	33.06.40.000576	33.06.40.000648
	5597	47	33.06.40.000577	33.06.40.000649
830	7467	59	33.06.40.000578	33.06.40.000650
	11476	94	33.06.40.000579	33.06.40.000651
1110	13487	107	33.06.40.000580	33.06.40.000652
	20659	172	33.06.40.000581	33.06.40.000653
<b>4000 K</b>				
400	2110	18	33.06.40.001152	33.06.40.001156
	2943	26	33.06.40.001153	33.06.40.001157
550	3654	30	33.06.40.000594	33.06.40.000666
	5597	47	33.06.40.000595	33.06.40.000667
830	7467	59	33.06.40.000596	33.06.40.000668
	11476	94	33.06.40.000597	33.06.40.000669
1110	13487	107	33.06.40.000598	33.06.40.000670
	20659	172	33.06.40.000599	33.06.40.000671

Micro Prismatic Diffuser - UGR<19

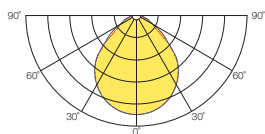

COMPONENTS

SUSPENSION SYSTEM

S1

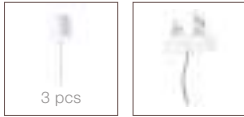

3 pcs  
3 Points Suspension +  
Recessed Ceiling Cup

S2



3 pcs  
3 Points Suspension +  
Surface Ceiling Cup

S3



1 Point Suspension +  
Surface Ceiling Cup

ON/OFF	1 m	3 m	5 m
S1 - Matt White Ø80 mm	35.06.40.001634	35.06.40.002263	35.06.40.002266
S2 - Matt White Ø103x36 mm	35.06.40.001635	35.06.40.002264	35.06.40.002267
S3 - Matt White Ø120x30 mm	35.06.40.001636	35.06.40.002265	35.06.40.002268

DALI	1 m	3 m	5 m
S1 - Matt White Ø80 mm	35.06.40.002283	35.06.40.002284	35.06.40.002285
S2 - Matt White Ø103x36 mm	35.06.40.002286	35.06.40.002287	35.06.40.002288
S3 - Matt White Ø120x30 mm	35.06.40.002289	35.06.40.002290	35.06.40.002291



# ASTRA 150 DIRECT LIGHT

## SUSPENDED



### PT

- > Luminária de luz homogénea com emissão direta do fluxo luminoso.
- > De aplicação suspensa por cabos de aço inox com ajuste rápido da altura.
- > Disponível em cinco diâmetros standard ou personalizados até 6 metros.
- > Fixação magnética do corpo à base da luminária.
- > Difusor Policarbonato Opal para iluminação homogénea, difusa e eficiente.
- > Corpo único em alumínio sem parafusos visíveis.
- > Acabamento exterior da luminária na cor escolhida pelo cliente, sempre com interior branco para manter a uniformidade da luz e elevado coeficiente de reflexão.

### ES

- > Luminaria de luz homogénea con emisión directa del flujo luminoso.
- > De aplicación suspendida por cables de acero inoxidable con regulación de la altura.
- > Disponible en cinco diámetros estándar o personalizados hasta 6 metros.
- > Fijación magnética del cuerpo a la base de la luminaria.
- > Difusor Policarbonato Opal.
- > Cuerpo en aluminio en una sola pieza sin tornillos visibles.
- > Acabado exterior en el color elegido por el cliente, siempre con interior en blanco para asegurar la uniformidad de la luz y un buen coeficiente de reflexión.



**QUICK INFO**

**GENERAL**

Suspended  
 IP40  
 850°C  
 Class I  
 Ta= -20°C +35°C

**OPTIC**

Opal Polycarbonate

**LED**

Efficacy up to 179 lm/W  
 3000 K, 4000 K  
 CRI >80  
 Lifetime 72 000 H  
 L80/B10 @TC=65°C

**ELETRICAL SYSTEM**

230V/50Hz  
 ON/OFF, DALI

**FINISHING**

RAL 9003 Matt White  
 RAL 9005 Matt Black

**OPTIONS**

**LED**

2700 K, 5000 K, 6500 K  
 Tunable White, RGB, RGBW  
 CRI >90

**ELECTRICAL SYSTEM**

DSI, DIM 1-10V, Phase-cut

**CONTROL SYSTEM**

Bluetooth

**FINISHING**

 Other Colours

**EMERGENCY**

1 Hour, 3 Hours  
 DALI 1 Hour, 3 Hours

**SENSORS**

Motion  
 Ambient Light  
 Motion & Ambient Light

**ASTRA 150 SUSPENDED - DIRECT LIGHT  
 OPAL DIFFUSER**

**MATT WHITE FINISHING**

Ø (mm)	Output (lm)	System (W)	ON/OFF	DALI
<b>3000 K</b>				
400	1853	20	33.06.40.400000	33.06.40.400004
	2670	32	33.06.40.400001	33.06.40.400005
650	3763	40	33.06.40.600000	33.06.40.600004
	5111	59	33.06.40.600001	33.06.40.600005
800	6882	67	33.06.40.800000	33.06.40.800004
	9356	99	33.06.40.800001	33.06.40.800005
1000	11398	107	33.06.40.100025	33.06.40.100029
	15480	158	33.06.40.100026	33.06.40.100030
1200	17080	160	33.06.40.120000	33.06.40.120004
	23221	235	33.06.40.120001	33.06.40.120005
<b>4000 K</b>				
400	1853	20	33.06.40.400002	33.06.40.400006
	2670	32	33.06.40.400003	33.06.40.400007
650	3763	40	33.06.40.600002	33.06.40.600006
	5111	59	33.06.40.600003	33.06.40.600007
800	6882	67	33.06.40.800002	33.06.40.800006
	9356	99	33.06.40.800003	33.06.40.800007
1000	11398	107	33.06.40.100027	33.06.40.100031
	15480	158	33.06.40.100028	33.06.40.100032
1200	17080	160	33.06.40.120002	33.06.40.120006
	23221	235	33.06.40.120003	33.06.40.120007

> Fluorescent lamp versions also available – product data at [www.climarlighting.com](http://www.climarlighting.com) – or by direct request to the factory.

**DIRECT LIGHT**

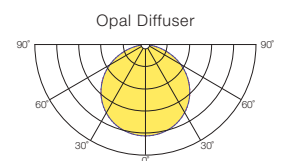
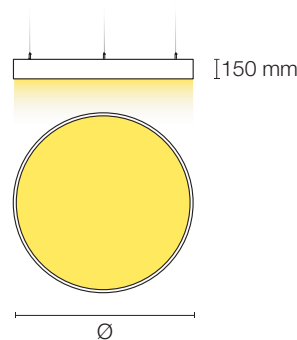

**QUICK INFO**

**GENERAL**

Suspended  
 IP40  
 850°C  
 Class I  
 Ta= -20°C +35°C

**OPTIC**

Opal Polycarbonate

**LED**

Efficacy up to 179 lm/W  
 3000 K, 4000 K  
 CRI >80  
 Lifetime 72 000 H  
 L80/B10 @TC=65°C

**ELETRICAL SYSTEM**

230V/50Hz  
 ON/OFF, DALI

**FINISHING**

RAL 9003 Matt White  
 RAL 9005 Matt Black

**OPTIONS**

**LED**

2700 K, 5000 K, 6500 K  
 Tunable White, RGB, RGBW  
 CRI >90

**ELECTRICAL SYSTEM**

DSI, DIM 1-10V, Phase-cut

**CONTROL SYSTEM**

Bluetooth

**FINISHING**

 Other Colours

**EMERGENCY**

1 Hour, 3 Hours  
 DALI 1 Hour, 3 Hours

**SENSORS**

Motion  
 Ambient Light  
 Motion & Ambient Light

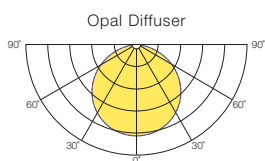

**ASTRA 150 SUSPENDED - DIRECT LIGHT  
 OPAL DIFFUSER**

**MATT BLACK FINISHING**

Ø (mm)	Output (lm)	System (W)	ON/OFF	DALI
<b>3000 K</b>				
400	1853	20	33.06.40.400008	33.06.40.400012
	2670	32	33.06.40.400009	33.06.40.400013
650	3763	40	33.06.40.600008	33.06.40.600012
	5111	59	33.06.40.600009	33.06.40.600013
800	6882	67	33.06.40.800008	33.06.40.800012
	9356	99	33.06.40.800009	33.06.40.800013
1000	11398	107	33.06.40.100033	33.06.40.100037
	15480	158	33.06.40.100034	33.06.40.100038
1200	17080	160	33.06.40.120008	33.06.40.120012
	23221	235	33.06.40.120009	33.06.40.120013
<b>4000 K</b>				
400	1853	20	33.06.40.400010	33.06.40.400014
	2670	32	33.06.40.400011	33.06.40.400015
650	3763	40	33.06.40.600010	33.06.40.600014
	5111	59	33.06.40.600011	33.06.40.600015
800	6882	67	33.06.40.800010	33.06.40.800014
	9356	99	33.06.40.800011	33.06.40.800015
1000	11398	107	33.06.40.100035	33.06.40.100039
	15480	158	33.06.40.100036	33.06.40.100040
1200	17080	160	33.06.40.120010	33.06.40.120014
	23221	235	33.06.40.120011	33.06.40.120015

> Fluorescent lamp versions also available – product data at [www.climarlighting.com](http://www.climarlighting.com) – or by direct request to the factory.

**COMPONENTS**

**SUSPENSION SYSTEM**

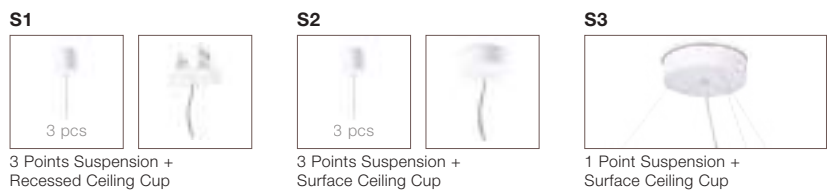

ON/OFF	1 m	3 m	5 m
S1 - White Ø80 mm	35.06.40.001634	35.06.40.002263	35.06.40.002266
S2 - White Ø103x36 mm	35.06.40.001635	35.06.40.002264	35.06.40.002267
S3 - White Ø120x30 mm	35.06.40.001636	35.06.40.002265	35.06.40.002268

DALI	1 m	3 m	5 m
S1 - White Ø80 mm	35.06.40.002283	35.06.40.002284	35.06.40.002285
S2 - White Ø103x36 mm	35.06.40.002286	35.06.40.002287	35.06.40.002288
S3 - White Ø120x30 mm	35.06.40.002289	35.06.40.002290	35.06.40.002291



> ASTRA 150 SUSPENDED

# ASTRA 90 DIRECT & INDIRECT LIGHT SUSPENDED



## PT

- > Luminária de luz homogénea com emissão direta (70%) e indireta (30%) do fluxo.
- > De aplicação suspensa por cabos de aço inox com ajuste rápido da altura.
- > Disponível em quatro diâmetros standard ou personalizados até 6 metros.
- > Fixação magnética do corpo à base da luminária.
- > Difusor PMMA Microprismático para controlo do encandeamento (UGR <19) ou difusor Policarbonato Opal para luz difusa.
- > Corpo único em alumínio sem parafusos visíveis.
- > Acabamento exterior da luminária na cor escolhida pelo cliente, sempre com interior branco para manter a uniformidade da luz e elevado coeficiente de reflexão.

## ES

- > Luminaria de luz homogénea con emisión directa (70%) e indirecta (30%) del flujo.
- > De aplicación suspendida por cables de acero inoxidable con regulación de la altura.
- > Disponible en cuatro diámetros estándar o personalizados hasta 6 metros.
- > Fijación magnética del cuerpo a la base de la luminaria.
- > Difusor PMMA Microprismático para control del deslumbramiento (UGR <19) o difusor Policarbonato Opal.
- > Cuerpo en aluminio en una sola pieza sin tornillos visibles.
- > Acabado exterior en el color elegido por el cliente, siempre con interior en blanco para asegurar la uniformidad de la luz y un buen coeficiente de reflexión.

DIRECT & INDIRECT LIGHT

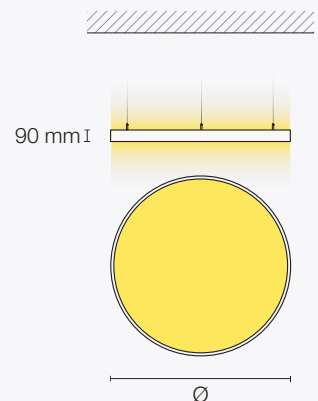

**QUICK INFO**

**GENERAL**

Suspended  
 IP40  
 850°C  
 Class I  
 Ta= -20°C +35°C

**OPTIC**

Opal Polycarbonate

**LED**

Efficacy up to 187 lm/W  
 3000 K, 4000 K  
 CRI >80  
 Lifetime 50 000 H  
 L80/B10 @TC=65°C

**ELECTRICAL SYSTEM**

230V/50Hz  
 ON/OFF, DALI  
 Direct / Indirect - Simultaneous Control

**FINISHING**

RAL 9003 Matt White  
 RAL 9005 Matt Black

**OPTIONS**

**LED**

2700 K, 5000 K, 6500 K  
 Tunable White, RGB, RGBW  
 CRI >90

**ELECTRICAL SYSTEM**

DSI, DIM 1-10V, Phase-cut  
 Direct / Indirect - Separate Control

**CONTROL SYSTEM**

Bluetooth

**FINISHING**

Other Colours

**EMERGENCY**

1 Hour, 3 Hours  
 DALI 1 Hour, 3 Hours

**SENSORS**

Motion  
 Ambient Light  
 Motion & Ambient Light

**ASTRA 90 SUSPENDED - DIRECT & INDIRECT LIGHT  
 OPAL DIFFUSER**

**MATT WHITE FINISHING**

Ø (mm)	Output (lm)	System (W)	ON/OFF	DALI
<b>3000 K</b>				
400	3508	31	33.06.40.001158	33.06.40.001162
	4683	43	33.06.40.001159	33.06.40.001163
550	5580	48	33.06.40.000782	33.06.40.000800
	7938	70	33.06.40.000783	33.06.40.000801
830	10318	86	33.06.40.000784	33.06.40.000802
	14965	129	33.06.40.000785	33.06.40.000803
1110	16825	142	33.06.40.000786	33.06.40.000804
	24594	218	33.06.40.000787	33.06.40.000805
<b>4000 K</b>				
400	3508	31	33.06.40.001174	33.06.40.001178
	4683	43	33.06.40.001175	33.06.40.001179
550	5580	48	33.06.40.000818	33.06.40.000836
	7938	70	33.06.40.000819	33.06.40.000837
830	10318	86	33.06.40.000820	33.06.40.000838
	14965	129	33.06.40.000821	33.06.40.000839
1110	16825	142	33.06.40.000822	33.06.40.000840
	24594	218	33.06.40.000823	33.06.40.000841

**MATT BLACK FINISHING**

Ø (mm)	Output (lm)	System (W)	ON/OFF	DALI
<b>3000 K</b>				
400	3508	31	33.06.40.001160	33.06.40.001164
	4683	43	33.06.40.001161	33.06.40.001165
550	5580	48	33.06.40.000794	33.06.40.000812
	7938	70	33.06.40.000795	33.06.40.000813
830	10318	86	33.06.40.000796	33.06.40.000814
	14965	129	33.06.40.000797	33.06.40.000815
1110	16825	142	33.06.40.000798	33.06.40.000816
	24594	218	33.06.40.000799	33.06.40.000817
<b>4000 K</b>				
400	3508	31	33.06.40.001176	33.06.40.001180
	4683	43	33.06.40.001177	33.06.40.001181
550	5580	48	33.06.40.000830	33.06.40.000848
	7938	70	33.06.40.000831	33.06.40.000849
830	10318	86	33.06.40.000832	33.06.40.000850
	14965	129	33.06.40.000833	33.06.40.000851
1110	16825	142	33.06.40.000834	33.06.40.000852
	24594	218	33.06.40.000835	33.06.40.000853

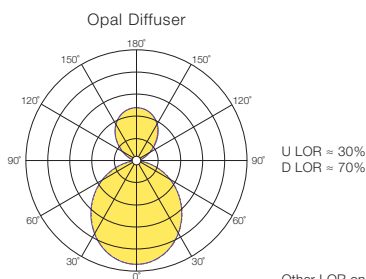

**QUICK INFO**

**GENERAL**

Suspended  
 IP40  
 650°C  
 Class I  
 Ta= -20°C +35°C

**OPTIC**

Micro Prismatic PMMA - UGR <19

**LED**

Efficacy up to 187 lm/W  
 3000 K, 4000 K  
 CRI >80  
 Lifetime 50 000 H  
 L80/B10 @TC=65°C

**ELETRICAL SYSTEM**

230V/50Hz  
 ON/OFF, DALI  
 Direct / Indirect - Simultaneous Control

**FINISHING**

RAL 9003 Matt White  
 RAL 9005 Matt Black

**OPTIONS**

**LED**

2700 K, 5000 K, 6500 K  
 Tunable White, RGB, RGBW  
 CRI >90

**ELECTRICAL SYSTEM**

DSI, DIM 1-10V, Phase-cut  
 Direct / Indirect - Separate Control

**CONTROL SYSTEM**

Bluetooth

**FINISHING**

Other Colours

**EMERGENCY**

1 Hour, 3 Hours  
 DALI 1 Hour, 3 Hours

**SENSORS**

Motion  
 Ambient Light  
 Motion & Ambient Light

Micro Prismatic Diffuser - UGR<19

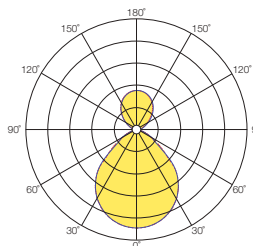

U LOR = 30%  
 D LOR = 70%

Other LOR on request.

**ASTRA 90 SUSPENDED - DIRECT & INDIRECT LIGHT  
 MICRO PRISMATIC DIFFUSER - UGR <19**

**MATT WHITE FINISHING**

Ø (mm)	Output (lm)	System (W)	ON/OFF	DALI
<b>3000 K</b>				
400	3598	31	33.06.40.001166	33.06.40.001170
	3597	43	33.06.40.001167	33.06.40.001171
550	5735	48	33.06.40.000854	33.06.40.000872
	8177	70	33.06.40.000855	33.06.40.000873
830	10556	86	33.06.40.000856	33.06.40.000874
	15302	129	33.06.40.000857	33.06.40.000875
1110	17504	142	33.06.40.000858	33.06.40.000876
	19531	218	33.06.40.000859	33.06.40.000877
<b>4000 K</b>				
400	3598	31	33.06.40.001182	33.06.40.001186
	3597	43	33.06.40.001183	33.06.40.001187
550	5735	48	33.06.40.000890	33.06.40.000908
	8177	70	33.06.40.000891	33.06.40.000909
830	10556	86	33.06.40.000892	33.06.40.000910
	15302	129	33.06.40.000893	33.06.40.000911
1110	17504	142	33.06.40.000894	33.06.40.000912
	19531	218	33.06.40.000895	33.06.40.000913

**MATT BLACK FINISHING**

Ø (mm)	Output (lm)	System (W)	ON/OFF	DALI
<b>3000 K</b>				
400	3598	31	33.06.40.001168	33.06.40.001172
	3597	43	33.06.40.001169	33.06.40.001173
550	5735	48	33.06.40.000866	33.06.40.000884
	8177	70	33.06.40.000867	33.06.40.000885
830	10556	86	33.06.40.000868	33.06.40.000886
	15302	129	33.06.40.000869	33.06.40.000887
1110	17504	142	33.06.40.000870	33.06.40.000888
	19531	218	33.06.40.000871	33.06.40.000889
<b>4000 K</b>				
400	3598	31	33.06.40.001184	33.06.40.001188
	3597	43	33.06.40.001185	33.06.40.001189
550	5735	48	33.06.40.000902	33.06.40.000920
	8177	70	33.06.40.000903	33.06.40.000921
830	10556	86	33.06.40.000904	33.06.40.000922
	15302	129	33.06.40.000905	33.06.40.000923
1110	17504	142	33.06.40.000906	33.06.40.000924
	19531	218	33.06.40.000907	33.06.40.000925

**COMPONENTS**

**SUSPENSION SYSTEM**

**S1**

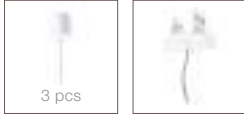

3 pcs  
3 Points Suspension + Recessed Ceiling Cup

**S2**



3 pcs  
3 Points Suspension + Surface Ceiling Cup

**S3**



1 Point Suspension + Surface Ceiling Cup

<b>ON/OFF</b>	<b>1 m</b>	<b>3 m</b>	<b>5 m</b>
S1 - Matt White Ø80 mm	35.06.40.001634	35.06.40.002263	35.06.40.002266
S2 - Matt White Ø103x36 mm	35.06.40.001635	35.06.40.002264	35.06.40.002267
S3 - Matt White Ø120x30 mm	35.06.40.001636	35.06.40.002265	35.06.40.002268

<b>DALI</b>	<b>1 m</b>	<b>3 m</b>	<b>5 m</b>
S1 - Matt White Ø80 mm	35.06.40.002283	35.06.40.002284	35.06.40.002285
S2 - Matt White Ø103x36 mm	35.06.40.002286	35.06.40.002287	35.06.40.002288
S3 - Matt White Ø120x30 mm	35.06.40.002289	35.06.40.002290	35.06.40.002291



# ASTRA 150

DIRECT & INDIRECT LIGHT  
SUSPENDED



## PT

- > Luminária de luz homogénea com emissão direta (70%) e indireta (30%) do fluxo.
- > De aplicação suspensa por cabos de aço inox com ajuste rápido da altura.
- > Disponível em cinco diâmetros standard ou personalizados até 6 metros.
- > Fixação magnética do corpo à base da luminária.
- > Difusor Policarbonato Opal para iluminação homogénea, difusa e eficiente.
- > Corpo único em alumínio sem parafusos visíveis.
- > Acabamento exterior da luminária na cor escolhida pelo cliente, sempre com interior branco para manter a uniformidade da luz e elevado coeficiente de reflexão.

## ES

- > Luminaria de luz homogénea con emisión directa (70%) e indirecta (30%) del flujo.
- > De aplicación suspendida por cables de acero inoxidable con regulación de la altura.
- > Disponible en cinco diámetros estándar o personalizados hasta 6 metros.
- > Fijación magnética del cuerpo a la base de la luminaria.
- > Difusor Policarbonato Opal.
- > Cuerpo en aluminio en una sola pieza sin tornillos visibles.
- > Acabado exterior en el color elegido por el cliente, siempre con interior en blanco para asegurar la uniformidad de la luz y un buen coeficiente de reflexión.



**QUICK INFO**

**GENERAL**

Suspended  
 IP40  
 850°C  
 Class I  
 Ta= -20°C +35°C

**OPTIC**

Opal Polycarbonate

**LED**

Efficacy up to 179 lm/W  
 3000 K, 4000 K  
 CRI >80  
 Lifetime 72 000 H  
 L80/B10 @TC=65°C

**ELETRICAL SYSTEM**

230V/50Hz  
 ON/OFF, DALI  
 Direct / Indirect - Simultaneous Control

**FINISHING**

RAL 9003 Matt White  
 RAL 9005 Matt Black

**OPTIONS**

**LED**

2700 K, 5000 K, 6500 K  
 Tunable White, RGB, RGBW  
 CRI >90

**ELECTRICAL SYSTEM**

DSI, DIM 1-10V, Phase-cut  
 Direct / Indirect - Separate Control

**CONTROL SYSTEM**

Bluetooth

**FINISHING**

 Other Colours

**EMERGENCY**

1 Hour, 3 Hours  
 DALI 1 Hour, 3 Hours

**SENSORS**

Motion  
 Ambient Light  
 Motion & Ambient Light

**ASTRA 150 SUSPENDED - DIRECT & INDIRECT LIGHT  
 OPAL DIFFUSER**

**MATT WHITE FINISHING**

Ø (mm)	Output (lm)	System (W)	ON/OFF	DALI
<b>3000 K</b>				
400	3341	33	33.06.40.400024	33.06.40.400028
	4535	50	33.06.40.400025	33.06.40.400029
650	5752	58	33.06.40.600024	33.06.40.600028
	7597	82	33.06.40.600025	33.06.40.600029
800	9833	93	33.06.40.800024	33.06.40.800028
	12306	133	33.06.40.800025	33.06.40.800029
1000	15235	142	33.06.40.100049	33.06.40.100053
	20276	203	33.06.40.100050	33.06.40.100054
1200	21876	204	33.06.40.120024	33.06.40.120028
	29215	293	33.06.40.120025	33.06.40.120029
<b>4000 K</b>				
400	3341	33	33.06.40.400026	33.06.40.400030
	4535	50	33.06.40.400027	33.06.40.400031
650	5752	58	33.06.40.600026	33.06.40.600030
	7597	82	33.06.40.600027	33.06.40.600031
800	9833	93	33.06.40.800026	33.06.40.800030
	12306	133	33.06.40.800027	33.06.40.800031
1000	15235	142	33.06.40.100051	33.06.40.100055
	20276	203	33.06.40.100052	33.06.40.100056
1200	21876	204	33.06.40.120026	33.06.40.120030
	29215	293	33.06.40.120027	33.06.40.120031

> Fluorescent lamp versions also available – product data at [www.climarlighting.com](http://www.climarlighting.com) – or by direct request to the factory.

**DIRECT & INDIRECT LIGHT**

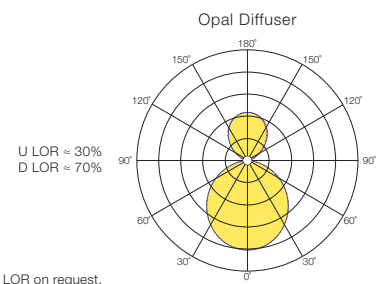
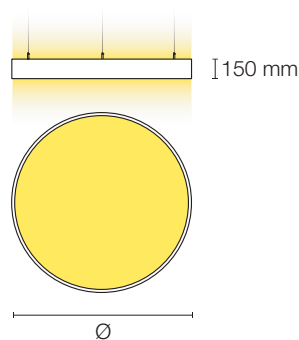

**QUICK INFO**

**GENERAL**

Suspended  
 IP40  
 850°C  
 Class I  
 Ta= -20°C +35°C

**OPTIC**

Opal Polycarbonate

**LED**

Efficacy up to 179 lm/W  
 3000 K, 4000 K  
 CRI >80  
 Lifetime 72 000 H  
 L80/B10 @TC=65°C

**ELETRICAL SYSTEM**

230V/50Hz  
 ON/OFF, DALI  
 Direct / Indirect - Simultaneous Control

**FINISHING**

RAL 9003 Matt White  
 RAL 9005 Matt Black

**OPTIONS**

**LED**

2700 K, 5000 K, 6500 K  
 Tunable White, RGB, RGBW  
 CRI >90

**ELECTRICAL SYSTEM**

DSI, DIM 1-10V, Phase-cut  
 Direct / Indirect - Separate Control

**CONTROL SYSTEM**

Bluetooth

**FINISHING**

Other Colours

**EMERGENCY**

1 Hour, 3 Hours  
 DALI 1 Hour, 3 Hours

**SENSORS**

Motion  
 Ambient Light  
 Motion & Ambient Light

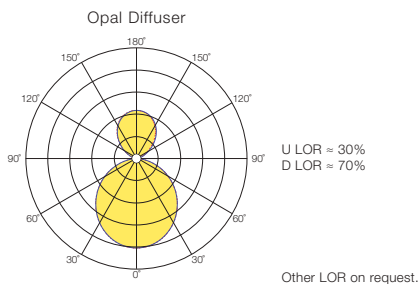

**ASTRA 150 SUSPENDED - DIRECT & INDIRECT LIGHT  
 OPAL DIFFUSER**

**MATT BLACK FINISHING**

Ø (mm)	Output (lm)	System (W)	ON/OFF	DALI
<b>3000 K</b>				
400	3341	33	33.06.40.400032	33.06.40.400036
	4535	50	33.06.40.400033	33.06.40.400037
650	5752	58	33.06.40.600032	33.06.40.600036
	7597	82	33.06.40.600033	33.06.40.600037
800	9833	93	33.06.40.800032	33.06.40.800036
	12306	133	33.06.40.800033	33.06.40.800037
1000	15235	142	33.06.40.100057	33.06.40.100061
	20276	203	33.06.40.100058	33.06.40.100062
1200	21876	204	33.06.40.120032	33.06.40.120036
	29215	293	33.06.40.120033	33.06.40.120037
<b>4000 K</b>				
400	3341	33	33.06.40.400034	33.06.40.400038
	4535	50	33.06.40.400035	33.06.40.400039
650	5752	58	33.06.40.600034	33.06.40.600038
	7597	82	33.06.40.600035	33.06.40.600039
800	9833	93	33.06.40.800034	33.06.40.800038
	12306	133	33.06.40.800035	33.06.40.800039
1000	15235	142	33.06.40.100059	33.06.40.100063
	20276	203	33.06.40.100060	33.06.40.100064
1200	21876	204	33.06.40.120034	33.06.40.120038
	29215	293	33.06.40.120035	33.06.40.120039

> Fluorescent lamp versions also available – product data at [www.climarlighting.com](http://www.climarlighting.com) – or by direct request to the factory.

**COMPONENTS**

**SUSPENSION SYSTEM**

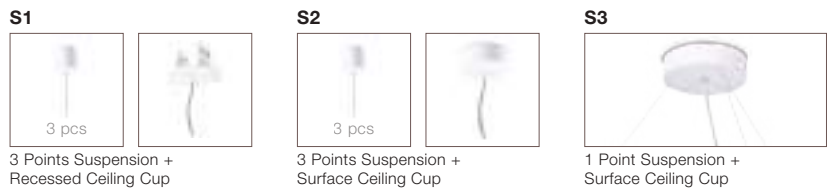

ON/OFF	1 m	3 m	5 m
S1 - White Ø80 mm	35.06.40.001634	35.06.40.002263	35.06.40.002266
S2 - White Ø103x36 mm	35.06.40.001635	35.06.40.002264	35.06.40.002267
S3 - White Ø120x30 mm	35.06.40.001636	35.06.40.002265	35.06.40.002268

DALI	1 m	3 m	5 m
S1 - White Ø80 mm	35.06.40.002283	35.06.40.002284	35.06.40.002285
S2 - White Ø103x36 mm	35.06.40.002286	35.06.40.002287	35.06.40.002288
S3 - White Ø120x30 mm	35.06.40.002289	35.06.40.002290	35.06.40.002291



> ASTRA 150 LD/LI SUSPENDED

# ASTRA 90

## SURFACE



### PT

- > Luminária de luz homogénea para aplicação saliente.
- > Disponível em quatro diâmetros standard ou personalizados até 6 metros.
- > Fixação magnética do corpo à base da luminária.
- > Difusor PMMA Microprismático para controlo do encandeamento (UGR <19) ou difusor Policarbonato Opal para luz difusa.
- > Corpo único em alumínio sem parafusos visíveis.
- > Acabamento exterior da luminária na cor escolhida pelo cliente, sempre com interior branco para manter a uniformidade da luz e elevado coeficiente de reflexão.

### ES

- > Luminaria de luz homogénea para instalación en superficie.
- > Disponible en cuatro diámetros estándar o personalizados hasta 6 metros.
- > Fijación magnética del cuerpo a la base de la luminaria.
- > Difusor PMMA Microprismático para control del deslumbramiento (UGR <19) o difusor Policarbonato Opal.
- > Cuerpo en aluminio en una sola pieza sin tornillos visibles.
- > Acabado exterior en el color elegido por el cliente, siempre con interior en blanco para asegurar la uniformidad de la luz y un buen coeficiente de reflexión.

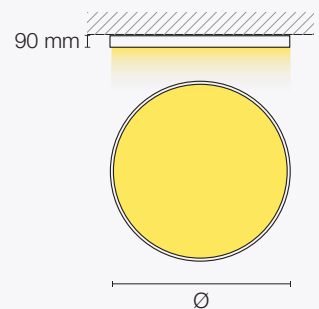

**QUICK INFO**

**GENERAL**

Surface  
 IP40  
 850°C  
 Class I  
 Ta= -20°C +35°C

**OPTIC**

Opal Polycarbonate

**LED**

Efficacy up to 187 lm/W  
 3000 K, 4000 K  
 CRI >80  
 Lifetime 50 000 H  
 L80/B10 @TC=65°C

**ELETRICAL SYSTEM**

230V/50Hz  
 ON/OFF, DALI

**FINISHING**

RAL 9003 Matt White  
 RAL 9005 Matt Black

**OPTIONS**

**LED**

2700 K, 5000 K, 6500 K  
 Tunable White, RGB, RGBW  
 CRI >90

**ELECTRICAL SYSTEM**

DSI, DIM 1-10V, Phase-cut

**CONTROL SYSTEM**

Bluetooth

**FINISHING**

 Other Colours

**EMERGENCY**

1 Hour, 3 Hours  
 DALI 1 Hour, 3 Hours

**SENSORS**

Motion  
 Ambient Light  
 Motion & Ambient Light

**ASTRA 90 SURFACE**

**OPAL DIFFUSER**

**MATT WHITE FINISHING**

Ø (mm)	Output (lm)	System (W)	ON/OFF	DALI
<b>3000 K</b>				
400	2020	18	33.06.30.000401	33.06.30.000405
	2818	26	33.06.30.000402	33.06.30.000412
550	3498	30	33.06.30.000208	33.06.30.000280
	5358	47	33.06.30.000209	33.06.30.000281
830	7228	59	33.06.30.000210	33.06.30.000282
	11138	94	33.06.30.000211	33.06.30.000283
1110	12808	107	33.06.30.000212	33.06.30.000284
	19619	172	33.06.30.000213	33.06.30.000285
<b>4000 K</b>				
400	2020	18	33.06.30.000379	33.06.30.000383
	2818	26	33.06.30.000380	33.06.30.000384
550	3498	30	33.06.30.000226	33.06.30.000298
	5358	47	33.06.30.000227	33.06.30.000299
830	7228	59	33.06.30.000228	33.06.30.000300
	11138	94	33.06.30.000229	33.06.30.000301
1110	12808	107	33.06.30.000230	33.06.30.000302
	19619	172	33.06.30.000231	33.06.30.000303

**MATT BLACK FINISHING**

Ø (mm)	Output (lm)	System (W)	ON/OFF	DALI
<b>3000 K</b>				
400	2020	18	33.06.30.000403	33.06.30.000413
	2818	26	33.06.30.000404	33.06.30.000414
550	3498	30	33.06.30.000220	33.06.30.000292
	5358	47	33.06.30.000221	33.06.30.000293
830	7228	59	33.06.30.000222	33.06.30.000294
	11138	94	33.06.30.000223	33.06.30.000295
1110	12808	107	33.06.30.000224	33.06.30.000296
	19619	172	33.06.30.000225	33.06.30.000297
<b>4000 K</b>				
400	2020	18	33.06.30.000381	33.06.30.000385
	2818	26	33.06.30.000382	33.06.30.000386
550	3498	30	33.06.30.000238	33.06.30.000310
	5358	47	33.06.30.000239	33.06.30.000311
830	7228	59	33.06.30.000240	33.06.30.000312
	11138	94	33.06.30.000241	33.06.30.000313
1110	12808	107	33.06.30.000242	33.06.30.000314
	19619	172	33.06.30.000243	33.06.30.000315

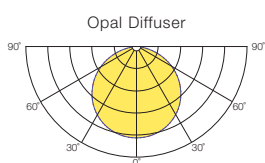

**QUICK INFO**

**GENERAL**

Surface  
 IP40  
 650°C  
 Class I  
 Ta= -20°C +35°C

**OPTIC**

Micro Prismatic PMMA - UGR <19

**LED**

Efficacy up to 187 lm/W  
 3000 K, 4000 K  
 CRI >80  
 Lifetime 50 000 H  
 L80/B10 @TC=65°C

**ELETRICAL SYSTEM**

230V/50Hz  
 ON/OFF, DALI

**FINISHING**

RAL 9003 Matt White  
 RAL 9005 Matt Black

**OPTIONS**

**LED**

2700 K, 5000 K, 6500 K  
 Tunable White, RGB, RGBW  
 CRI >90

**ELECTRICAL SYSTEM**

DSI, DIM 1-10V, Phase-cut

**CONTROL SYSTEM**

Bluetooth

**FINISHING**

 Other Colours

**EMERGENCY**

1 Hour, 3 Hours  
 DALI 1 Hour, 3 Hours

**SENSORS**

Motion  
 Ambient Light  
 Motion & Ambient Light

**ASTRA 90 SURFACE**

**MICRO PRISMATIC DIFFUSER - UGR <19**

**MATT WHITE FINISHING**

Ø (mm)	Output (lm)	System (W)	ON/OFF	DALI
<b>3000 K</b>				
400	2110	18	33.06.30.000365	33.06.30.000369
	2943	26	33.06.30.000366	33.06.30.000376
550	3654	30	33.06.30.000244	33.06.30.000316
	5597	47	33.06.30.000245	33.06.30.000317
830	7467	59	33.06.30.000246	33.06.30.000318
	11476	94	33.06.30.000247	33.06.30.000319
1110	13487	107	33.06.30.000248	33.06.30.000320
	20659	172	33.06.30.000249	33.06.30.000321
<b>4000 K</b>				
400	2110	18	33.06.30.000387	33.06.30.000397
	2943	26	33.06.30.000394	33.06.30.000398
550	3654	30	33.06.30.000262	33.06.30.000334
	5597	47	33.06.30.000263	33.06.30.000335
830	7467	59	33.06.30.000264	33.06.30.000336
	11476	94	33.06.30.000265	33.06.30.000337
1110	13487	107	33.06.30.000266	33.06.30.000338
	20659	172	33.06.30.000267	33.06.30.000339

**MATT BLACK FINISHING**

Ø (mm)	Output (lm)	System (W)	ON/OFF	DALI
<b>3000 K</b>				
400	2110	18	33.06.30.000367	33.06.30.000377
	2943	26	33.06.30.000368	33.06.30.000378
550	3654	30	33.06.30.000256	33.06.30.000328
	5597	47	33.06.30.000257	33.06.30.000329
830	7467	59	33.06.30.000258	33.06.30.000330
	11476	94	33.06.30.000259	33.06.30.000331
1110	13487	107	33.06.30.000260	33.06.30.000332
	20659	172	33.06.30.000261	33.06.30.000333
<b>4000 K</b>				
400	2110	18	33.06.30.000395	33.06.30.000399
	2943	26	33.06.30.000396	33.06.30.000400
550	3654	30	33.06.30.000274	33.06.30.000346
	5597	47	33.06.30.000275	33.06.30.000347
830	7467	59	33.06.30.000276	33.06.30.000348
	11476	94	33.06.30.000277	33.06.30.000349
1110	13487	107	33.06.30.000278	33.06.30.000350
	20659	172	33.06.30.000279	33.06.30.000351

Micro Prismatic Diffuser - UGR<19

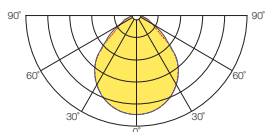

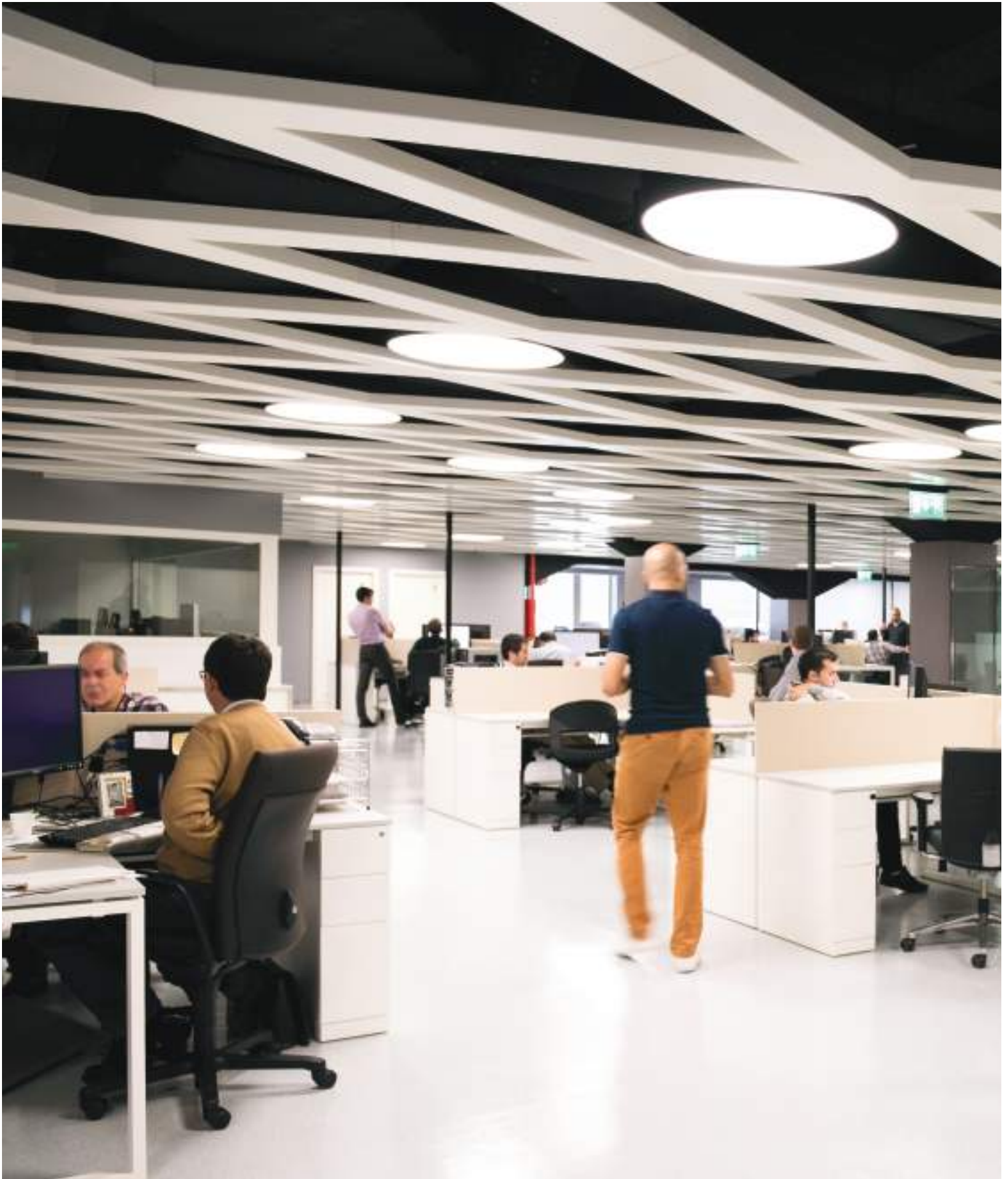

# ASTRA 150

## SURFACE



### PT

- > Luminária de luz homogénea com emissão direta do fluxo luminoso.
- > De aplicação saliente.
- > Disponível em cinco diâmetros standard ou personalizados até 6 metros.
- > Fixação magnética do corpo à base da luminária.
- > Difusor Policarbonato Opal para iluminação homogénea, difusa e eficiente.
- > Corpo único em alumínio sem parafusos visíveis.
- > Acabamento exterior da luminária na cor escolhida pelo cliente, sempre com interior branco para manter a uniformidade da luz e elevado coeficiente de reflexão.

### ES

- > Luminaria de luz homogénea con emisión directa del flujo luminoso.
- > De aplicación en superficie.
- > Disponible en cinco diámetros estándar o personalizados hasta 6 metros.
- > Fijación magnética del cuerpo a la base de la luminaria.
- > Difusor Policarbonato Opal.
- > Cuerpo en aluminio en una sola pieza sin tornillos visibles.
- > Acabado exterior en el color elegido por el cliente, siempre con interior en blanco para asegurar la uniformidad de la luz y un buen coeficiente de reflexión.



**QUICK INFO**

**GENERAL**

Surface  
 IP40  
 850°C  
 Class I  
 Ta= -20°C +35°C

**OPTIC**

Opal Polycarbonate

**LED**

Efficacy up to 179 lm/W  
 3000 K, 4000 K  
 CRI >80  
 Lifetime 72 000 H  
 L80/B10 @TC=65°C

**ELETRICAL SYSTEM**

230V/50Hz  
 ON/OFF, DALI

**FINISHING**

RAL 9003 Matt White  
 RAL 9005 Matt Black

**OPTIONS**

**LED**

2700 K, 5000 K, 6500 K  
 Tunable White, RGB, RGBW  
 CRI >90

**ELECTRICAL SYSTEM**

DSI, DIM 1-10V, Phase-cut

**CONTROL SYSTEM**

Bluetooth

**FINISHING**

 Other Colours

**EMERGENCY**

1 Hour, 3 Hours  
 DALI 1 Hour, 3 Hours

**SENSORS**

Motion  
 Ambient Light  
 Motion & Ambient Light

**ASTRA 150 SURFACE**

**OPAL DIFFUSER**

**MATT WHITE FINISHING**

Ø (mm)	Output (lm)	System (W)	ON/OFF	DALI
<b>3000 K</b>				
400	1853	20	33.06.30.400000	33.06.30.400004
	2670	32	33.06.30.400001	33.06.30.400005
650	3763	40	33.06.30.600000	33.06.30.600004
	5111	59	33.06.30.600001	33.06.30.600005
800	6882	67	33.06.30.800000	33.06.30.800004
	9356	99	33.06.30.800001	33.06.30.800005
1000	11388	107	33.06.30.100001	33.06.30.100005
	15480	158	33.06.30.100002	33.06.30.100006
1200	17080	160	33.06.30.120000	33.06.30.120004
	23221	235	33.06.30.120001	33.06.30.120005
<b>4000 K</b>				
400	1853	20	33.06.30.400002	33.06.30.400006
	2670	32	33.06.30.400003	33.06.30.400007
650	3763	40	33.06.30.600002	33.06.30.600006
	5111	59	33.06.30.600003	33.06.30.600007
800	6882	67	33.06.30.800002	33.06.30.800006
	9356	99	33.06.30.800003	33.06.30.800007
1000	11388	107	33.06.30.100003	33.06.30.100007
	15480	158	33.06.30.100004	33.06.30.100008
1200	17080	160	33.06.30.120002	33.06.30.120006
	23221	235	33.06.30.120003	33.06.30.120007

> Fluorescent lamp versions also available – product data at [www.climarlighting.com](http://www.climarlighting.com) – or by direct request to the factory.

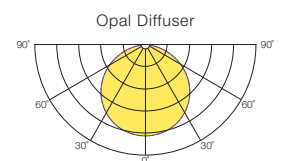
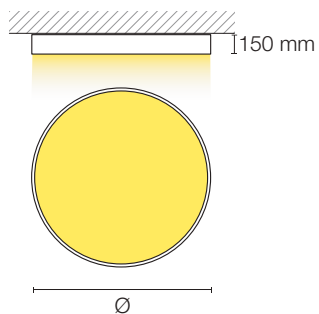

**QUICK INFO**

**GENERAL**

Surface  
 IP40  
 850°C  
 Class I  
 Ta= -20°C +35°C

**OPTIC**

Opal Polycarbonate

**LED**

Efficacy up to 179 lm/W  
 3000 K, 4000 K  
 CRI >80  
 Lifetime 72 000 H  
 L80/B10 @TC=65°C

**ELETRICAL SYSTEM**

230V/50Hz  
 ON/OFF, DALI

**FINISHING**

RAL 9003 Matt White  
 RAL 9005 Matt Black

**OPTIONS**

**LED**

2700 K, 5000 K, 6500 K  
 Tunable White, RGB, RGBW  
 CRI >90

**ELECTRICAL SYSTEM**

DSI, DIM 1-10V, Phase-cut

**CONTROL SYSTEM**

Bluetooth

**FINISHING**

 Other Colours

**EMERGENCY**

1 Hour, 3 Hours  
 DALI 1 Hour, 3 Hours

**SENSORS**

Motion  
 Ambient Light  
 Motion & Ambient Light

**ASTRA 150 SURFACE**

**OPAL DIFFUSER**

**MATT BLACK FINISHING**

Ø (mm)	Output (lm)	System (W)	ON/OFF	DALI
<b>3000 K</b>				
400	1853	20	33.06.30.400008	33.06.30.400012
	2670	32	33.06.30.400009	33.06.30.400013
650	3763	40	33.06.30.600008	33.06.30.600012
	5111	59	33.06.30.600009	33.06.30.600013
800	6882	67	33.06.30.800008	33.06.30.800012
	9356	99	33.06.30.800009	33.06.30.800013
1000	11388	107	33.06.30.100009	33.06.30.100013
	15480	158	33.06.30.100010	33.06.30.100014
1200	17080	160	33.06.30.120008	33.06.30.120012
	23221	235	33.06.30.120009	33.06.30.120013
<b>4000 K</b>				
400	1853	20	33.06.30.400010	33.06.30.400014
	2670	32	33.06.30.400011	33.06.30.400015
650	3763	40	33.06.30.600010	33.06.30.600014
	5111	59	33.06.30.600011	33.06.30.600015
800	6882	67	33.06.30.800010	33.06.30.800014
	9356	99	33.06.30.800011	33.06.30.800015
1000	11388	107	33.06.30.100011	33.06.30.100015
	15480	158	33.06.30.100012	33.06.30.100016
1200	17080	160	33.06.30.120010	33.06.30.120014
	23221	235	33.06.30.120011	33.06.30.120015

> Fluorescent lamp versions also available – product data at [www.climarlighting.com](http://www.climarlighting.com) – or by direct request to the factory.

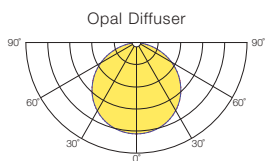



**ASTRA**  
TRIMLESS





THIS IS MY TRYP

我在TRYP里斯本

Eu estou no TRYP

I'm in TRYP

Yo estoy en TRYP en LISB

# ASTRA 90

## TRIMLESS



### PT

- > Luminária de luz homogénea para aplicação encastrada sem aba de remate (trimless).
- > Para integração com o mínimo de impacto visual em tetos falsos de gesso cartonado.
- > Disponível em quatro diâmetros standard ou personalizados até 6 metros.
- > Difusor PMMA Microprismático para controlo do encandeamento (UGR <19) ou difusor Policarbonato Opal para luz difusa.
- > Corpo em alumínio.

### ES

- > Luminaria de luz homogénea para instalación empotrada sin marco de remate (trimless).
- > Para integración con el mínimo impacto visual en techos falsos de placas de yeso.
- > Disponible en cuatro diámetros estándar o personalizados hasta 6 metros.
- > Difusor PMMA Microprismático para control del deslumbramiento (UGR <19) o difusor Policarbonato Opal.
- > Cuerpo en aluminio.

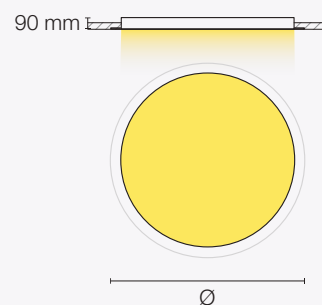

**QUICK INFO**

**GENERAL**

Trimless  
 IP23 (Optic)  
 IP20  
 850°C - Opal  
 650°C - Micro Prismatic PMMA  
 Class I  
 Ta= -20°C +35°C

**OPTIC**

Opal Polycarbonate  
 Micro Prismatic PMMA - UGR <19

**LED**

Efficacy up to 187 lm/W  
 3000 K, 4000 K  
 CRI >80  
 Lifetime 50 000 H  
 L80/B10 @Tc=65°C

**ELETRICAL SYSTEM**

230V/50Hz  
 ON/OFF, DALI

**FINISHING**

RAL 9003 Matt White

**ASTRA 90 TRIMLESS**

**OPAL DIFFUSER**

Ø (mm)	Output (lm)	System (W)	ON/OFF	DALI
<b>3000 K</b>				
400	2020	18	33.06.30.000415	33.06.30.000417
	2818	26	33.06.30.000416	33.06.30.000418
550	3498	30	33.06.30.000352	33.06.30.000424
	5358	47	33.06.30.000353	33.06.30.000425
830	7228	59	33.06.30.000354	33.06.30.000426
	11138	94	33.06.30.000355	33.06.30.000427
1110	12828	107	33.06.30.000356	33.06.30.000428
	19619	172	33.06.30.000357	33.06.30.000429
<b>4000 K</b>				
400	2020	18	33.06.30.000423	33.06.30.000431
	2818	26	33.06.30.000430	33.06.30.000432
550	3498	30	33.06.30.000370	33.06.30.000442
	5358	47	33.06.30.000371	33.06.30.000443
830	7228	59	33.06.30.000372	33.06.30.000444
	11138	94	33.06.30.000373	33.06.30.000445
1110	12828	107	33.06.30.000374	33.06.30.000446
	19619	172	33.06.30.000375	33.06.30.000447

**OPTIONS**

**LED**

2700 K, 5000 K, 6500 K  
 Tunable White, RGB, RGBW  
 CRI >90

**ELECTRICAL SYSTEM**

DSI, DIM 1-10V, Phase-cut

**CONTROL SYSTEM**

Bluetooth

**EMERGENCY**

1 Hour, 3 Hours  
 DALI 1 Hour, 3 Hours

**SENSORS**

Motion  
 Ambient Light  
 Motion & Ambient Light

**MICRO PRISMATIC DIFFUSER - UGR <19**

Ø (mm)	Output (lm)	System (W)	ON/OFF	DALI
<b>3000 K</b>				
400	2110	18	33.06.30.000419	33.06.30.000421
	2943	26	33.06.30.000420	33.06.30.000422
550	3654	30	33.06.30.000388	33.06.30.000460
	5597	47	33.06.30.000389	33.06.30.000461
830	7467	59	33.06.30.000390	33.06.30.000462
	11476	94	33.06.30.000391	33.06.30.000463
1110	13487	107	33.06.30.000392	33.06.30.000464
	20659	172	33.06.30.000393	33.06.30.000465
<b>4000 K</b>				
400	2110	18	33.06.30.000433	33.06.30.000435
	2943	26	33.06.30.000434	33.06.30.000436
550	3654	30	33.06.30.000406	33.06.30.000478
	5597	47	33.06.30.000407	33.06.30.000479
830	7467	59	33.06.30.000408	33.06.30.000480
	11476	94	33.06.30.000409	33.06.30.000481
1110	13487	107	33.06.30.000410	33.06.30.000482
	20659	172	33.06.30.000411	33.06.30.000483

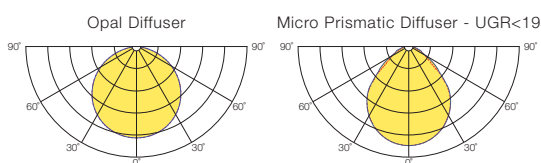

# ASTRA 150

## TRIMLESS



### PT

- > Luminária de luz perfeitamente homogénea para aplicação encastrada sem aba de remate (trimless).
- > Para integração com o mínimo de impacto visual em tetos falsos de gesso cartonado.
- > Disponível em cinco diâmetros standard ou personalizados até 6 metros.
- > Difusor Policarbonato Opal para iluminação homogénea, difusa e eficiente.
- > Corpo em alumínio.

### ES

- > Luminaria de luz perfectamente homogénea para instalación empotrada sin marco de remate (trimless).
- > Para integración con el mínimo impacto visual en techos falsos de placas de yeso.
- > Disponible en cinco diámetros estándar o personalizados hasta 6 metros.
- > Difusor Policarbonato Opal.
- > Cuerpo en aluminio.



**QUICK INFO**

**GENERAL**

Trimless  
 IP23 (Optic)  
 IP20  
 850°C  
 Class I  
 Ta= -20°C +35°C

**OPTIC**

Opal Polycarbonate

**LED**

Efficacy up to 179 lm/W  
 3000 K, 4000 K  
 CRI >80  
 Lifetime 72 000 H  
 L80/B10 @Tc=65°C

**ELETRICAL SYSTEM**

230V/50Hz  
 ON/OFF, DALI

**FINISHING**

RAL 9003 Matt White

**OPTIONS**

**LED**

2700 K, 5000 K, 6500 K  
 Tunable White, RGB, RGBW  
 CRI >90

**ELECTRICAL SYSTEM**

DSI, DIM 1-10V, Phase-cut

**CONTROL SYSTEM**

Bluetooth

**EMERGENCY**

1 Hour, 3 Hours  
 DALI 1Hour, 3 Hours

**SENSORS**

Motion  
 Ambient Light  
 Motion & Ambient Light

**ASTRA 150 TRIMLESS**

**OPAL DIFFUSER**

Ø (mm)	Output (lm)	System (W)	ON/OFF	DALI
<b>3000 K</b>				
400	1853	20	33.06.30.000110	33.06.30.000114
	2670	32	33.06.30.000111	33.06.30.000115
650	3763	40	33.06.30.000118	33.06.30.000122
	5111	59	33.06.30.000119	33.06.30.000123
800	6882	67	33.06.30.000126	33.06.30.000130
	9356	99	33.06.30.000127	33.06.30.000131
1000	11388	107	33.06.30.000134	33.06.30.000138
	15480	158	33.06.30.000135	33.06.30.000139
1200	17080	160	33.06.30.000142	33.06.30.000146
	23221	235	33.06.30.000143	33.06.30.000147
<b>4000 K</b>				
400	1853	20	33.06.30.000112	33.06.30.000116
	2670	32	33.06.30.000113	33.06.30.000117
650	3763	40	33.06.30.000120	33.06.30.000124
	5111	59	33.06.30.000121	33.06.30.000125
800	6882	67	33.06.30.000128	33.06.30.000132
	9356	99	33.06.30.000129	33.06.30.000133
1000	11388	107	33.06.30.000136	33.06.30.000140
	15480	158	33.06.30.000137	33.06.30.000141
1200	17080	160	33.06.30.000144	33.06.30.000148
	23221	235	33.06.30.000145	33.06.30.000149

> Fluorescent lamp versions also available – product data at [www.climarlighting.com](http://www.climarlighting.com) – or by direct request to the factory.

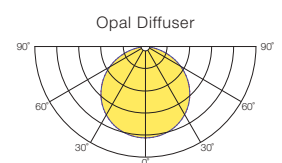
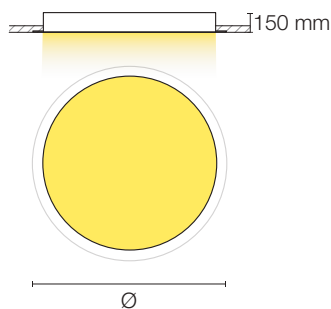

TUPOLI  
SUSPENDED





# TUPOLI 38 SUSPENDED

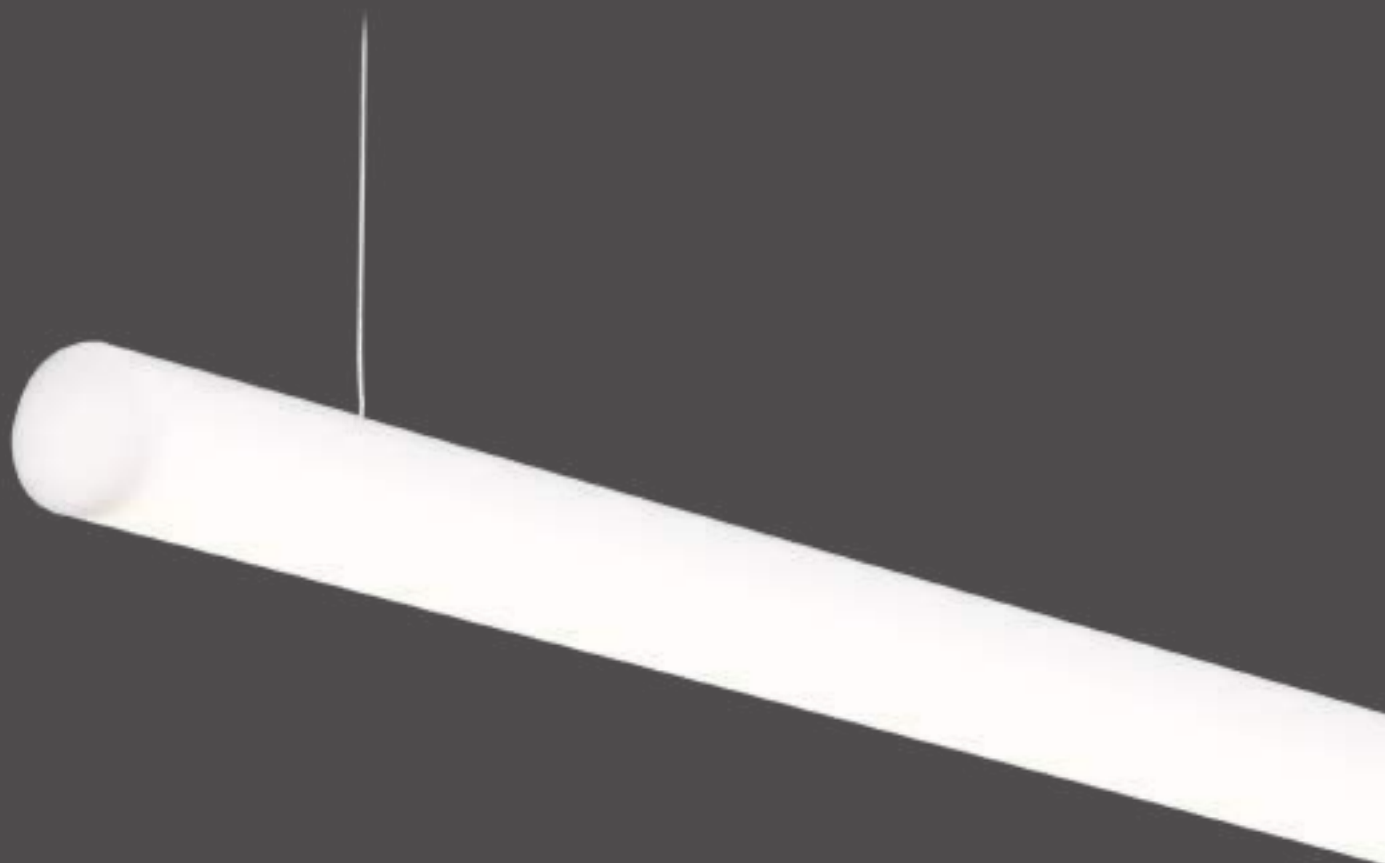

## PT

- > Luminária de luz homogénea com emissão do fluxo luminoso em 300°.
- > Aplicação suspensa em teto falso através de cabo de aço inox com ajuste rápido da altura.
- > Formato tubular com 38 mm de diâmetro.
- > Pode ser usada como luminária individual ou em grupos de luminárias alimentadas por um único Driver.
- > Driver externo de tensão constante e classe de proteção II.
- > Difusor tubular em PMMA Opal.
- > Topos em acrílico opaco branco.

## ES

- > Luminaria de luz homogénea con emisión luminosa en 300°.
- > Aplicación suspendida en falso techo por cable de acero inoxidable con regulación de la altura.
- > Formato tubular con 38 mm de diámetro.
- > Se puede usar como luminaria individual o en grupos de luminarias utilizando un solo Driver.
- > Driver externo de tensión constante y clase de protección II.
- > Difusor tubular en PMMA Opal.
- > Tapas finales en acrílico opaco blanco.

**QUICK INFO**

**GENERAL**

Suspended  
 IP40  
 IK04  
 650°C  
 Class III  
 Ta= -20°C +35°C

**OPTIC**

Opal PMMA

**LED**

Efficacy up to 122 lm/W  
 3000 K, 4200 K  
 CRI >80  
 Lifetime 30 000 H  
 L70/B10 @Tc=25°C  
 24 VDC

**ELETRICAL SYSTEM**

230V/50Hz  
 ON/OFF, DALI

**OPTIONS**

**LED**

2700 K, 5000 K, 6500 K  
 Tunable White, RGB, RGBW  
 CRI >90

**ELECTRICAL SYSTEM**

DSI, DIM 1-10V, Phase-cut

**CONTROL SYSTEM**

Bluetooth

**SENSORS**

Motion  
 Ambient Light  
 Motion & Ambient Light

**TUPOLI 38 SUSPENDED**

**OPAL DIFFUSER**

c (mm)	Output (lm)	LED Power (W)	LED Voltage	COD
<b>3000 K</b>				
994	1153	12	24 VDC	33.49.005.08.73
1500	1730	18	24 VDC	33.49.005.08.74
2000	2307	24	24 VDC	33.49.005.08.75
<b>4200 K</b>				
994	1203	12	24 VDC	33.49.005.08.76
1500	1805	18	24 VDC	33.49.005.08.77
2000	2405	24	24 VDC	33.49.005.08.78

**COMPONENTS**

**SUSPENSION SYSTEM (1pc)**



TYPE	1m	3m
Matt White	35.49.002.08.80	35.49.002.08.81

**RECESSED CEILING CUP (1pc)**



TYPE	1m	3m
Matt White Ø80 mm	35.49.002.08.78	35.49.002.08.79

**DRIVER - EXTERNAL**



CLASS II

ON/OFF	DIMENSION	COD
Power Supply 4-32W IP20	21x40x220 mm	35.00.003.01.75
Power Supply 6-49W IP20	21x40x250 mm	35.00.003.01.74
Power Supply 12-86W IP20	21x40x300 mm	35.00.003.01.73
DALI	DIMENSION	COD
Power Supply 12-90W IP20	30x43x295 mm	35.00.003.01.76
Power Supply 18-135W IP20	31x43x325 mm	35.00.003.01.77

> External Driver to be housed nearby.

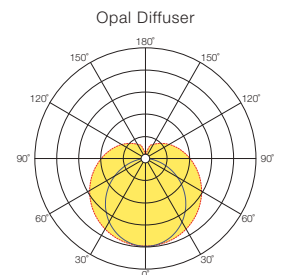
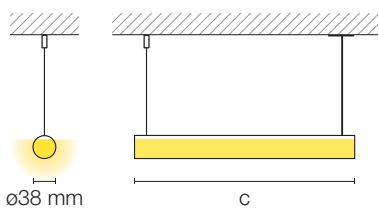

# TUPOLI 38

## SURFACE



### PT

- > Luminária de luz homogénea com emissão do fluxo luminoso em 300°.
- > Aplicação saliente em teto falso com peças de fixação em policarbonato.
- > Formato tubular com 38mm de diâmetro.
- > Pode ser usada como luminária individual ou em grupos de luminárias alimentadas por um único Driver.
- > Driver externo de tensão constante e classe de proteção II.
- > Difusor tubular em PMMA Opal.
- > Topos em acrílico opaco branco.

### ES

- > Luminaria de luz homogénea con emisión luminosa en 300°.
- > Aplicación en superficie al falso techo por soportes de fijación en policarbonato.
- > Formato tubular con 38mm de diámetro.
- > Se puede usar como luminaria individual o en grupos de luminarias utilizando un solo Driver.
- > Driver externo de tensión constante y clase de protección II.
- > Difusor tubular en PMMA Opal.
- > Tapas finales en acrílico opaco blanco.

**QUICK INFO**

**GENERAL**

Surface  
 IP40  
 IK04  
 650°C  
 Class III  
 Ta= -20°C +35°C

**OPTIC**

Opal PMMA

**LED**

Efficacy up to 122 lm/W  
 3000 K, 4200 K  
 CRI >80  
 Lifetime 30 000 H  
 L70/B10 @Tc=25°C  
 24 VDC

**ELETRICAL SYSTEM**

230V/50Hz  
 ON/OFF, DALI

**OPTIONS**

**LED**

2700 K, 5000 K, 6500 K  
 Tunable White, RGB, RGBW  
 CRI >90

**ELECTRICAL SYSTEM**

DSI, DIM 1-10V, Phase-cut

**CONTROL SYSTEM**

Bluetooth

**SENSORS**

Motion  
 Ambient Light  
 Motion & Ambient Light

**TUPOLI 38 SURFACE**

**OPAL DIFFUSER**

c (mm)	Output (lm)	LED Power (W)	LED Voltage	COD
<b>3000 K</b>				
994	1153	12	24 VDC	33.49.002.08.12
1500	1730	18	24 VDC	33.49.002.08.13
2000	2307	24	24 VDC	33.49.002.08.14
<b>4200 K</b>				
994	1203	12	24 VDC	33.49.002.08.15
1500	1805	18	24 VDC	33.49.002.08.16
2000	2405	24	24 VDC	33.49.002.08.17

**COMPONENTS**

**SURFACE MOUNTING SYSTEM (2pcs)**



TYPE	COD
Polycarbonate Mounting Brackets	35.49.001.08.29

**RECESSED CEILING CUP (1pc)**



TYPE	COD
Matt White Ø80 mm	35.49.001.08.55

**DRIVER - EXTERNAL**



CLASS II

ON/OFF	DIMENSION	COD
Power Supply 4-32W IP20	21x40x220 mm	35.00.003.01.75
Power Supply 6-49W IP20	21x40x250 mm	35.00.003.01.74
Power Supply 12-86W IP20	21x40x300 mm	35.00.003.01.73
DALI	DIMENSION	COD
Power Supply 12-90W IP20	30x43x295 mm	35.00.003.01.76
Power Supply 18-135W IP20	31x43x325 mm	35.00.003.01.77

> External Driver to be housed nearby.

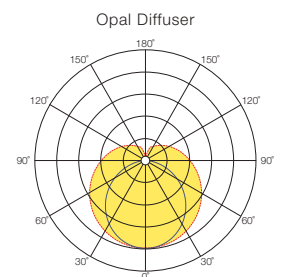
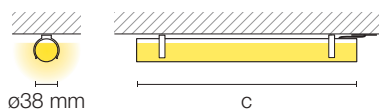

# TUPOLI 55 SUSPENDED



## PT

- > Luminária de luz homogénea com emissão direta do fluxo luminoso.
- > Aplicação suspensa por cabos de aço inox com ajuste rápido da altura.
- > Difusor tubular em Policarbonato Opal para iluminação homogénea, difusa e eficiente.
- > Refletor interno em alumínio para maior desempenho da luminária.
- > Topos em alumínio com acabamento branco mate.

## ES

- > Luminaria de luz homogénea con emisión directa del flujo luminoso.
- > Aplicación suspendida por cables de acero inoxidable con regulación de la altura.
- > Difusor tubular en Policarbonato Opal.
- > Reflector interno en aluminio para aumentar el rendimiento de la luminaria.
- > Tapas finales en aluminio con acabado blanco mate.



**QUICK INFO**

**GENERAL**

Suspended  
 IP40  
 IK08  
 850°C  
 Class I  
 Ta= -20°C +35°C

**OPTIC**

Opal Polycarbonate

**LED**

Efficacy up to 188 lm/W  
 3000 K, 4000 K  
 CRI >80  
 Lifetime 72 000 H  
 L80/B10 @Tc=55°C

**ELETRICAL SYSTEM**

230V/50Hz  
 ON/OFF, DALI

**OPTIONS**

**LED**

2700 K, 5000 K, 6500 K  
 Tunable White, RGB, RGBW  
 CRI >90

**ELECTRICAL SYSTEM**

DSI, DIM 1-10V, Phase-cut

**CONTROL SYSTEM**

Bluetooth

**EMERGENCY**

1 Hour, 3 Hours  
 DALI 1 Hour, 3 Hours

**SENSORS**

Motion  
 Ambient Light  
 Motion & Ambient Light

**TUPOLI 55 SUSPENDED**

**OPAL DIFFUSER**

c (mm)	Output (lm)	System (W)	ON/OFF	DALI
<b>3000 K</b>				
900	2323	19	33.49.003.08.14	33.49.003.08.23
1181	2287	18	33.49.003.08.15	33.49.003.08.24
	3096	26	33.49.003.08.16	33.49.003.08.25
1462	2858	23	33.49.003.08.17	33.49.003.08.26
	3871	32	33.49.003.08.18	33.49.003.08.27
2305	4574	36	33.49.003.08.19	33.49.003.08.28
	6193	52	33.49.003.08.20	33.49.003.08.29
2867	5716	45	33.49.003.08.21	33.49.003.08.30
	7742	64	33.49.003.08.22	33.49.003.08.31
<b>4000 K</b>				
900	2431	19	33.49.002.08.96	33.49.003.08.05
1181	2393	18	33.49.002.08.97	33.49.003.08.06
	3241	26	33.49.002.08.98	33.49.003.08.07
1462	2991	23	33.49.002.08.99	33.49.003.08.08
	4052	32	33.49.003.08.00	33.49.003.08.09
2305	4786	36	33.49.003.08.01	33.49.003.08.10
	6482	52	33.49.003.08.02	33.49.003.08.11
2867	5981	45	33.49.003.08.03	33.49.003.08.12
	8103	64	33.49.003.08.04	33.49.003.08.13

> Fluorescent lamp versions also available – product data at [www.climarlighting.com](http://www.climarlighting.com) – or by direct request to the factory.

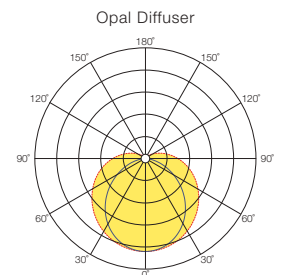
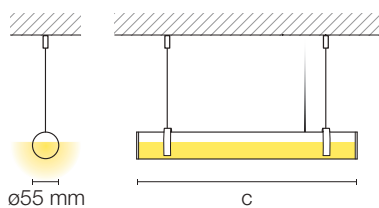

# TUPOLI 55

## SUSPENDED

### COMPONENTS



#### SUSPENSION SYSTEM (2pcs)

TYPE	1m	3m	5m
Matt White + Stainless Steel Cable	35.49.001.08.32	35.49.001.08.33	35.49.002.08.75



#### SURFACE CEILING CUP (1pc)

MATT WHITE	DIMENSION	1m	3m	5m
ON/OFF	Ø62x36 mm	35.49.001.08.30	35.49.002.08.59	35.49.002.08.67
ON/OFF + EM	Ø62x36 mm	35.49.001.08.46	35.49.002.08.60	35.49.002.08.68
DALI	Ø62x36 mm	35.49.001.08.47	35.49.002.08.61	35.49.002.08.69
DALI + EM	Ø103x36 mm	35.49.001.08.48	35.49.002.08.62	35.49.002.08.70



#### RECESSED CEILING CUP (1pc)

MATT WHITE	DIMENSION	1m	3m	5m
ON/OFF	Ø80 mm	35.49.001.08.31	35.49.002.08.63	35.49.002.08.71
ON/OFF + EM	Ø80 mm	35.49.001.08.49	35.49.002.08.64	35.49.002.08.72
DALI	Ø80 mm	35.49.001.08.50	35.49.002.08.65	35.49.002.08.73
DALI + EM	Ø80 mm	35.49.001.08.51	35.49.002.08.66	35.49.002.08.74

### OPTIONS



#### EMERGENCY (EM) - SELF-TEST INTEGRATED

ON/OFF	COD
EM 1H 3W	35.00.003.01.23*
DALI	COD
EM 1H 5,4W DALI	35.00.004.01.54*

\* Applies to lengths equal to or greater than 1181 mm.

> On request – External Emergency. Box dimensions: 45x120x360 mm.



# TUPOLI 70 SUSPENDED

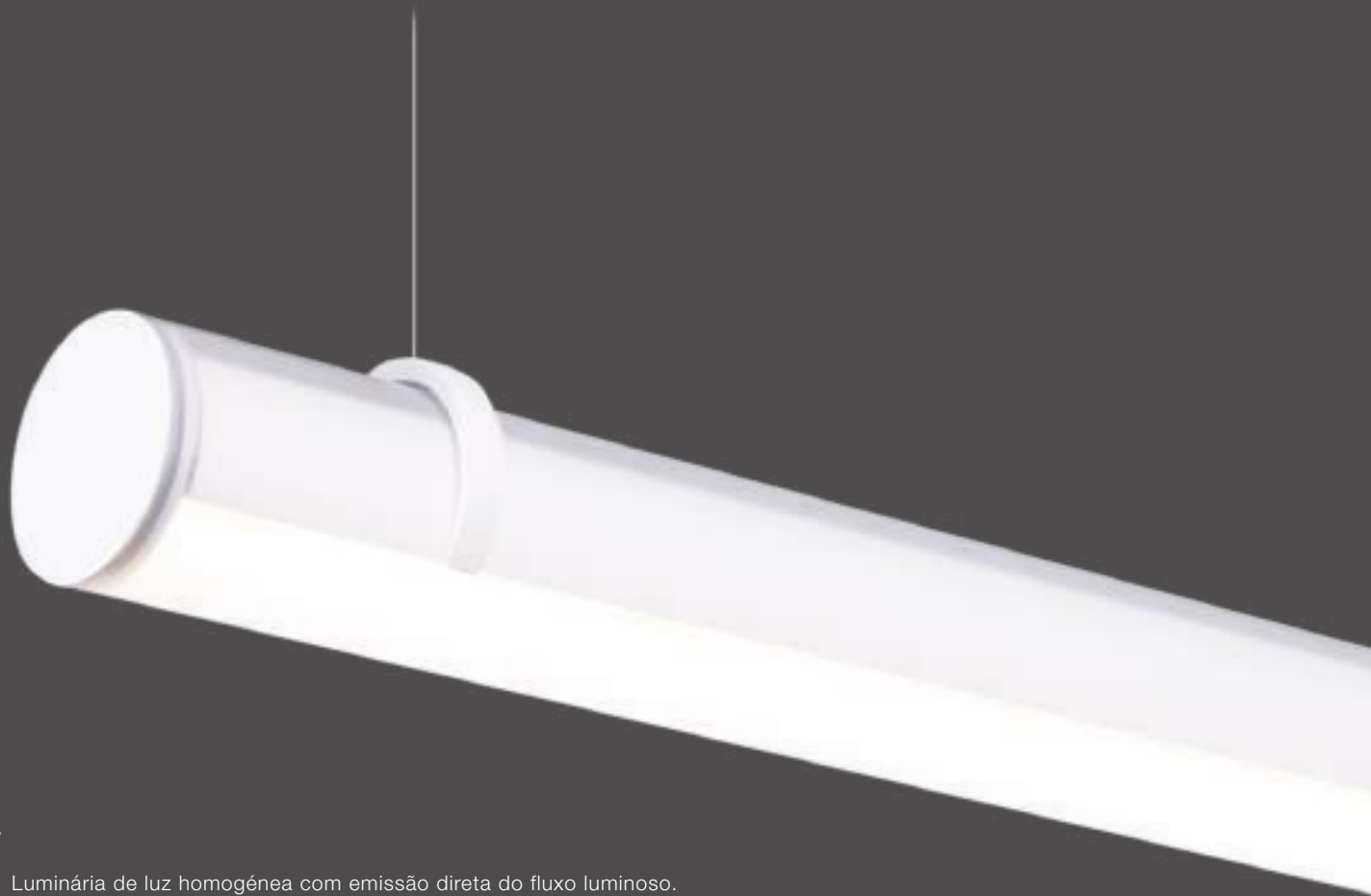

## PT

- > Luminária de luz homogénea com emissão direta do fluxo luminoso.
- > Aplicação suspensa por cabos de aço inox com ajuste rápido da altura.
- > Difusor tubular em Policarbonato Opal para iluminação homogénea, difusa e eficiente.
- > Refletor interno em alumínio para maior desempenho da luminária.
- > Topos em alumínio com acabamento branco mate.

## ES

- > Luminaria de luz homogénea con emisión directa del flujo luminoso.
- > Aplicación suspendida por cables de acero inoxidable con regulación de la altura.
- > Difusor tubular en Policarbonato Opal.
- > Reflector interno en aluminio para aumentar el rendimiento de la luminaria.
- > Tapas finales en aluminio con acabado blanco mate.

**QUICK INFO**

**GENERAL**

Suspended  
 IP40  
 IK08  
 850°C  
 Class I  
 Ta= -20°C +35°C

**OPTIC**

Opal Polycarbonate

**LED**

Efficacy up to 193 lm/W  
 3000 K, 4000 K  
 CRI >80  
 Lifetime 72 000 H  
 L80/B10 @Tc=65°C

**ELETRICAL SYSTEM**

230V/50Hz  
 ON/OFF, DALI

**OPTIONS**

**LED**

2700 K, 5000 K, 6500 K  
 Tunable White, RGB, RGBW  
 CRI >90

**ELECTRICAL SYSTEM**

DSI, DIM 1-10V, Phase-cut

**CONTROL SYSTEM**

Bluetooth

**EMERGENCY**

1 Hour, 3 Hours  
 DALI 1 Hour, 3 Hours

**SENSORS**

Motion  
 Ambient Light  
 Motion & Ambient Light

**TUPOLI 70 SUSPENDED**

**OPAL DIFFUSER**

c (mm)	Output (lm)	System (W)	ON/OFF	DALI
<b>3000 K</b>				
900	1880	14	33.49.005.08.18	33.49.005.08.19
	2705	22	33.49.003.08.32	33.49.003.08.41
	4440	38	33.49.006.08.92	33.49.006.08.97
1181	2506	19	33.49.003.08.33	33.49.003.08.42
	3607	29	33.49.003.08.34	33.49.003.08.43
	5919	51	33.49.006.08.93	33.49.006.08.98
1462	3133	24	33.49.003.08.35	33.49.003.08.44
	4509	37	33.49.003.08.36	33.49.003.08.45
	7399	63	33.49.006.08.94	33.49.006.08.99
2305	5013	38	33.49.003.08.37	33.49.003.08.46
	7213	58	33.49.003.08.38	33.49.003.08.47
	11839	101	33.49.006.08.95	33.49.007.08.00
2867	6266	48	33.49.003.08.39	33.49.003.08.48
	9018	73	33.49.003.08.40	33.49.003.08.49
	14798	127	33.49.006.08.96	33.49.007.08.01
<b>4000 K</b>				
900	1967	14	33.49.005.08.20	33.49.005.08.21
	2831	22	33.49.003.08.50	33.49.003.08.59
	4652	38	33.49.007.08.02	33.49.007.08.07
1181	2623	19	33.49.003.08.51	33.49.003.08.60
	3774	29	33.49.003.08.52	33.49.003.08.61
	6203	51	33.49.007.08.03	33.49.007.08.08
1462	3278	24	33.49.003.08.53	33.49.003.08.62
	4717	37	33.49.003.08.54	33.49.003.08.63
	7753	63	33.49.007.08.04	33.49.007.08.09
2305	5246	38	33.49.003.08.55	33.49.003.08.64
	7547	58	33.49.003.08.56	33.49.003.08.65
	12406	101	33.49.007.08.05	33.49.007.08.10
2867	6557	48	33.49.003.08.57	33.49.003.08.66
	9435	73	33.49.003.08.58	33.49.003.08.67
	15507	127	33.49.007.08.06	33.49.007.08.11

> Fluorescent lamp versions also available – product data at [www.climarlighting.com](http://www.climarlighting.com) – or by direct request to the factory.

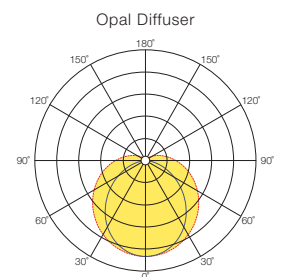
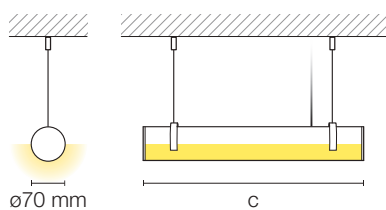

# TUPOLI 70

## SUSPENDED

### COMPONENTS



#### SUSPENSION SYSTEM (2pcs)

TYPE	1 m	3 m	5 m
Matt White + Stainless Steel Cable	35.49.003.01.48	35.49.003.01.49	35.49.002.08.76



#### SURFACE CEILING CUP (1pc)

MATT WHITE	DIMENSION	1 m	3 m	5 m
ON/OFF	Ø62x36 mm	35.49.001.08.30	35.49.002.08.59	35.49.002.08.67
ON/OFF + EM	Ø62x36 mm	35.49.001.08.46	35.49.002.08.60	35.49.002.08.68
DALI	Ø62x36 mm	35.49.001.08.47	35.49.002.08.61	35.49.002.08.69
DALI + EM	Ø103x36 mm	35.49.001.08.48	35.49.002.08.62	35.49.002.08.70



#### RECESSED CEILING CUP (1pc)

MATT WHITE	DIMENSION	1 m	3 m	5 m
ON/OFF	Ø80 mm	35.49.001.08.31	35.49.002.08.63	35.49.002.08.71
ON/OFF + EM	Ø80 mm	35.49.001.08.49	35.49.002.08.64	35.49.002.08.72
DALI	Ø80 mm	35.49.001.08.50	35.49.002.08.65	35.49.002.08.73
DALI + EM	Ø80 mm	35.49.001.08.51	35.49.002.08.66	35.49.002.08.74

### OPTIONS



#### EMERGENCY (EM) - SELF-TEST INTEGRATED

ON/OFF	COD
EM 1H 3W	35.00.003.01.23*
EM 3H 3W	35.00.003.01.24**
DALI	COD
EM 1H 5,4W DALI	35.00.004.01.54*
EM 3H 5,4W DALI	35.00.004.01.55**

\* Applies to lengths equal to or greater than 1181 mm. \*\* Applies to lengths equal to or greater than 1462 mm.  
 > On request - External Emergency. Box dimensions: 45x120x360 mm.



# TUPOLI 70 I-LIGHT

INVISIBLE LIGHT - UGR <13

## SUSPENDED



### PT

- > Luminária de luz invisível com excecional controlo do encandeamento.
- > Aplicação suspensa por cabos de aço inox com ajuste rápido da altura.
- > A fonte de luz é invisível, proporcionando elevado conforto visual com UGR <13 para máxima proteção anti-encandeamento.
- > A ótica com lente integrada permite ângulos de abertura de 16°, 40° e 35°x12° (elíptica).
- > Corpo tubular em policarbonato transparente resistente ao impacto.
- > Topos em alumínio.

### ES

- > Luminaria de luz invisible con excelente control del deslumbramiento.
- > Aplicación suspendida por cables de acero inoxidable con regulación de la altura.
- > La fuente de luz es invisible, ofreciendo un elevado confort visual con UGR <13 para máxima protección anti deslumbramiento.
- > La óptica con lente integrada permite ángulos de emisión de 16°, 40° y 35°x12° (elíptica).
- > Cuerpo tubular en policarbonato transparente resistente al impacto.
- > Tapas finales en aluminio.



**QUICK INFO**

**GENERAL**

Suspended  
 IP40  
 IK08  
 850°C  
 Class I  
 Ta= -20°C +35°C

**OPTIC**

Clear Polycarbonate

**LED**

Efficacy up to 143 lm/W  
 3000 K, 4000 K  
 CRI >90  
 Lifetime 80 000 H  
 L80/B10 @Tc=65°C

**ELETRICAL SYSTEM**

230V/50Hz  
 ON/OFF, DALI

**FINISHING**

RAL 9005 Matt Black

**TUPOLI 70 I-LIGHT SUSPENDED  
 CLEAR DIFFUSER**

**MATT BLACK FINISHING**

Beam Angle (°)	c (mm)	Output (lm)	System (W)	ON/OFF	DALI
<b>3000 K</b>					
16°	1176	3560	28	33.49.006.08.47	33.49.006.08.53
	1459	4450	35	33.49.006.08.50	33.49.006.08.56
40°	1176	3591	28	33.49.006.08.48	33.49.006.08.54
	1459	4488	35	33.49.006.08.51	33.49.006.08.57
Elliptical 35° x 12°	1176	3348	28	33.49.006.08.49	33.49.006.08.55
	1459	4185	35	33.49.006.08.52	33.49.006.08.58
<b>4000 K</b>					
16°	1176	3615	28	33.49.006.08.59	33.49.006.08.65
	1459	4518	35	33.49.006.08.62	33.49.006.08.68
40°	1176	3646	28	33.49.006.08.60	33.49.006.08.66
	1459	4557	35	33.49.006.08.63	33.49.006.08.69
Elliptical 35° x 12°	1176	3399	28	33.49.006.08.61	33.49.006.08.67
	1459	4249	35	33.49.006.08.64	33.49.006.08.70

**OPTIONS**

**LED**

2700 K, 5000 K, 6500 K

**ELECTRICAL SYSTEM**

DSI, DIM 1-10V, Phase-cut

**CONTROL SYSTEM**

Bluetooth

**FINISHING**

 Other Colours

**EMERGENCY**

1 Hour, 3 Hours  
 DALI 1 Hour, 3 Hours

**SENSORS**

Motion  
 Ambient Light  
 Motion & Ambient Light

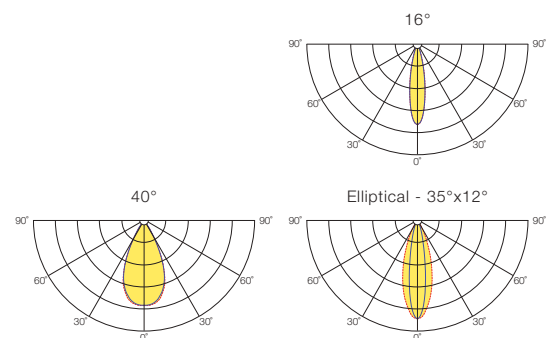
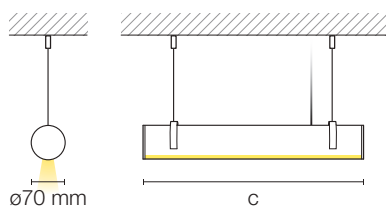

# TUPOLI 70 I-LIGHT SUSPENDED

## COMPONENTS



### SUSPENSION SYSTEM (2pcs)

TYPE	1 m	3 m	5 m
Matt Black + Stainless Steel Cable	35.49.002.08.97	35.49.002.08.98	35.49.002.08.99



### SURFACE CEILING CUP (1pc)

MATT WHITE	DIMENSION	1 m	3 m	5 m
ON/OFF	Ø62x36 mm	35.49.001.08.30	35.49.002.08.59	35.49.002.08.67
ON/OFF + EM	Ø62x36 mm	35.49.001.08.46	35.49.002.08.60	35.49.002.08.68
DALI	Ø62x36 mm	35.49.001.08.47	35.49.002.08.61	35.49.002.08.69
DALI + EM	Ø103x36 mm	35.49.001.08.48	35.49.002.08.62	35.49.002.08.70



### RECESSED CEILING CUP (1pc)

MATT WHITE	DIMENSION	1 m	3 m	5 m
ON/OFF	Ø80 mm	35.49.001.08.31	35.49.002.08.63	35.49.002.08.71
ON/OFF + EM	Ø80 mm	35.49.001.08.49	35.49.002.08.64	35.49.002.08.72
DALI	Ø80 mm	35.49.001.08.50	35.49.002.08.65	35.49.002.08.73
DALI + EM	Ø80 mm	35.49.001.08.51	35.49.002.08.66	35.49.002.08.74



> TUPOLI 70 I-LIGHT SUSPENDEO

# TUPOLI-V 70

## SUSPENDED

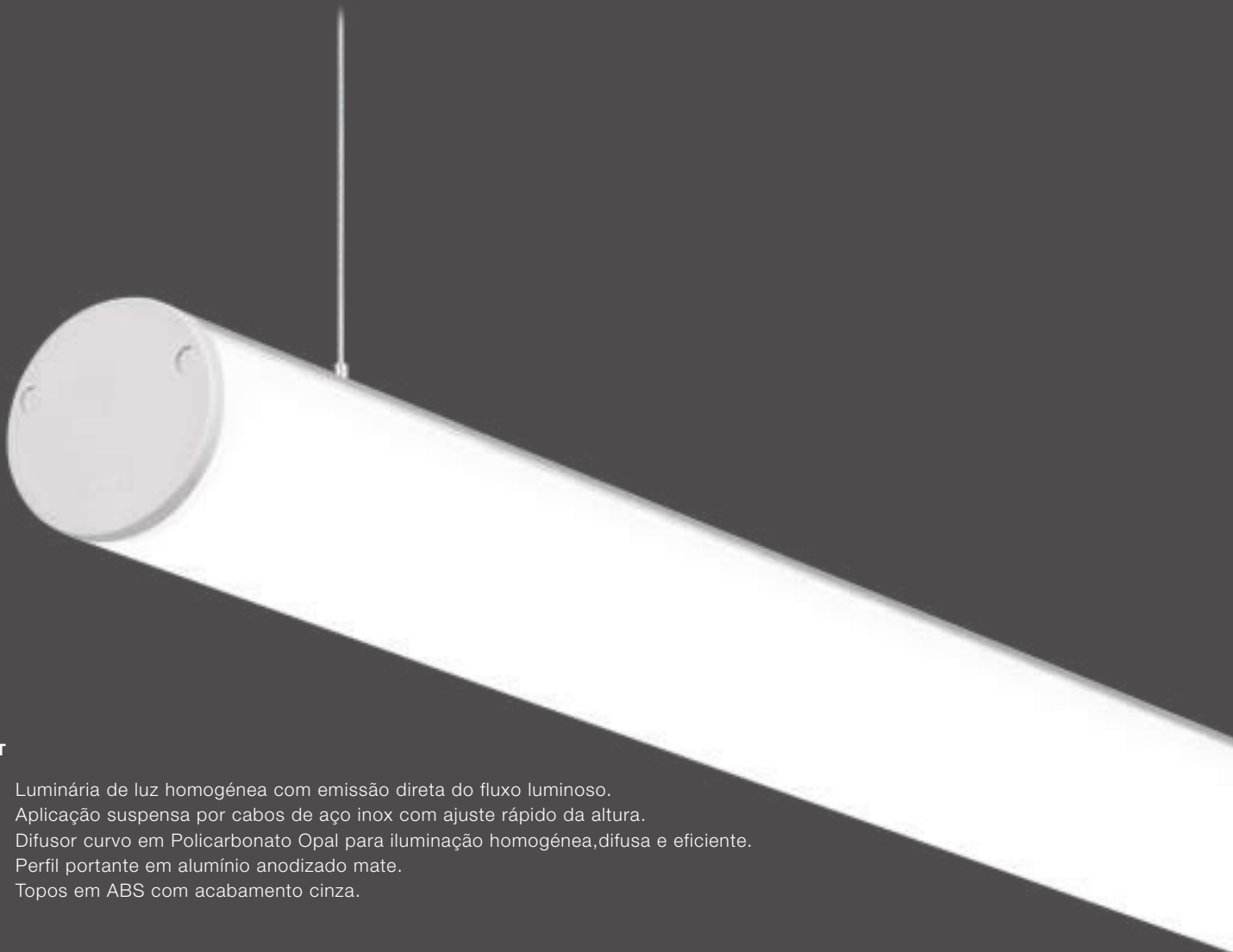

### PT

- > Luminária de luz homogénea com emissão direta do fluxo luminoso.
- > Aplicação suspensa por cabos de aço inox com ajuste rápido da altura.
- > Difusor curvo em Policarbonato Opal para iluminação homogénea, difusa e eficiente.
- > Perfil portante em alumínio anodizado mate.
- > Topos em ABS com acabamento cinza.

### ES

- > Luminaria de luz homogénea con emisión directa del flujo luminoso.
- > Aplicación suspendida por cables de acero inoxidable con regulación de la altura.
- > Difusor curvo en Policarbonato Opal.
- > Perfil soporte fabricado en aluminio anodizado mate.
- > Tapas finales en ABS acabado gris.

**QUICK INFO**

**GENERAL**

Suspended  
 IP40  
 IK04  
 850°C  
 Class I  
 Ta= -20°C +35°C

**OPTIC**

Opal Polycarbonate

**LED**

Efficacy up to 171 lm/W  
 3000 K, 4000 K  
 CRI >80  
 Lifetime 72 000 H  
 L80/B10 @Tc=65°C

**ELETRICAL SYSTEM**

230V/50Hz  
 ON/OFF, DALI

**FINISHING**

Matt Anodized

**OPTIONS**

**LED**

2700 K, 5000 K, 6500 K  
 Tunable White, RGB, RGBW  
 CRI >90

**ELECTRICAL SYSTEM**

DSI, DIM 1-10V, Phase-cut

**CONTROL SYSTEM**

Bluetooth

**FINISHING**

 Other Colours

**EMERGENCY**

1 Hour, 3 Hours  
 DALI 1 Hour, 3 Hours

**SENSORS**

Motion  
 Ambient Light  
 Motion & Ambient Light

**TUPOLI-V 70 SUSPENDED**

**OPAL DIFFUSER**

c (mm)	Output (lm)	System (W)	ON/OFF	DALI
<b>3000 K</b>				
868	2177	19	33.49.004.08.72	33.49.004.08.82
	4353	38	33.49.004.08.73	33.49.004.08.83
1149	2901	25	33.49.004.08.74	33.49.004.08.84
	5805	50	33.49.004.08.75	33.49.004.08.85
1430	3627	31	33.49.004.08.76	33.49.004.08.86
	7255	63	33.49.004.08.77	33.49.004.08.87
2273	5803	50	33.49.004.08.78	33.49.004.08.88
	11609	101	33.49.004.08.79	33.49.004.08.89
2835	7254	63	33.49.004.08.80	33.49.004.08.90
	14511	126	33.49.004.08.81	33.49.004.08.91
<b>4000 K</b>				
868	2278	19	33.49.004.08.92	33.49.005.08.02
	4555	38	33.49.004.08.93	33.49.005.08.03
1149	3037	25	33.49.004.08.94	33.49.005.08.04
	6073	50	33.49.004.08.95	33.49.005.08.05
1430	3796	31	33.49.004.08.96	33.49.005.08.06
	7591	63	33.49.004.08.97	33.49.005.08.07
2273	6073	50	33.49.004.08.98	33.49.005.08.08
	12146	101	33.49.004.08.99	33.49.005.08.09
2835	7592	63	33.49.005.08.00	33.49.005.08.10
	15183	126	33.49.005.08.01	33.49.005.08.11

> Fluorescent lamp versions also available – product data at [www.climarlighting.com](http://www.climarlighting.com) – or by direct request to the factory.

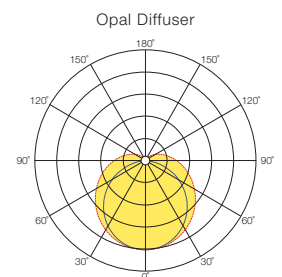
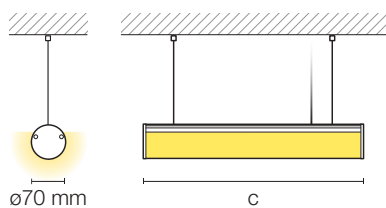

# TUPOLI-V 70

## SUSPENDED

### COMPONENTS



#### SUSPENSION SYSTEM (2pcs)

TYPE	1 m	3 m	5 m
Matt White + Stainless Steel Cable	35.42.000.01.54	35.42.000.01.62	35.42.001.01.26



#### SURFACE CEILING CUP (1pc)

MATT WHITE	DIMENSION	1 m	3 m	5 m
ON/OFF	Ø62x36 mm	35.49.001.08.30	35.49.002.08.59	35.49.002.08.67
ON/OFF + EM	Ø62x36 mm	35.49.001.08.46	35.49.002.08.60	35.49.002.08.68
DALI	Ø62x36 mm	35.49.001.08.47	35.49.002.08.61	35.49.002.08.69
DALI + EM	Ø103x36 mm	35.49.001.08.48	35.49.002.08.62	35.49.002.08.70



#### RECESSED CEILING CUP (1pc)

MATT WHITE	DIMENSION	1 m	3 m	5 m
ON/OFF	Ø80 mm	35.49.001.08.31	35.49.002.08.63	35.49.002.08.71
ON/OFF + EM	Ø80 mm	35.49.001.08.49	35.49.002.08.64	35.49.002.08.72
DALI	Ø80 mm	35.49.001.08.50	35.49.002.08.65	35.49.002.08.73
DALI + EM	Ø80 mm	35.49.001.08.51	35.49.002.08.66	35.49.002.08.74

### OPTIONS



#### EMERGENCY (EM) - SELF-TEST INTEGRATED

ON/OFF	COD
EM 1H 3W	35.00.003.01.23*
DALI	COD
EM 1H 5,4W DALI	35.00.004.01.54*

\* Applies to lengths equal to or greater than 1430 mm.

> On request – External Emergency. Box dimensions: 45x120x360 mm.



# TUPOLI-V 70

## SURFACE

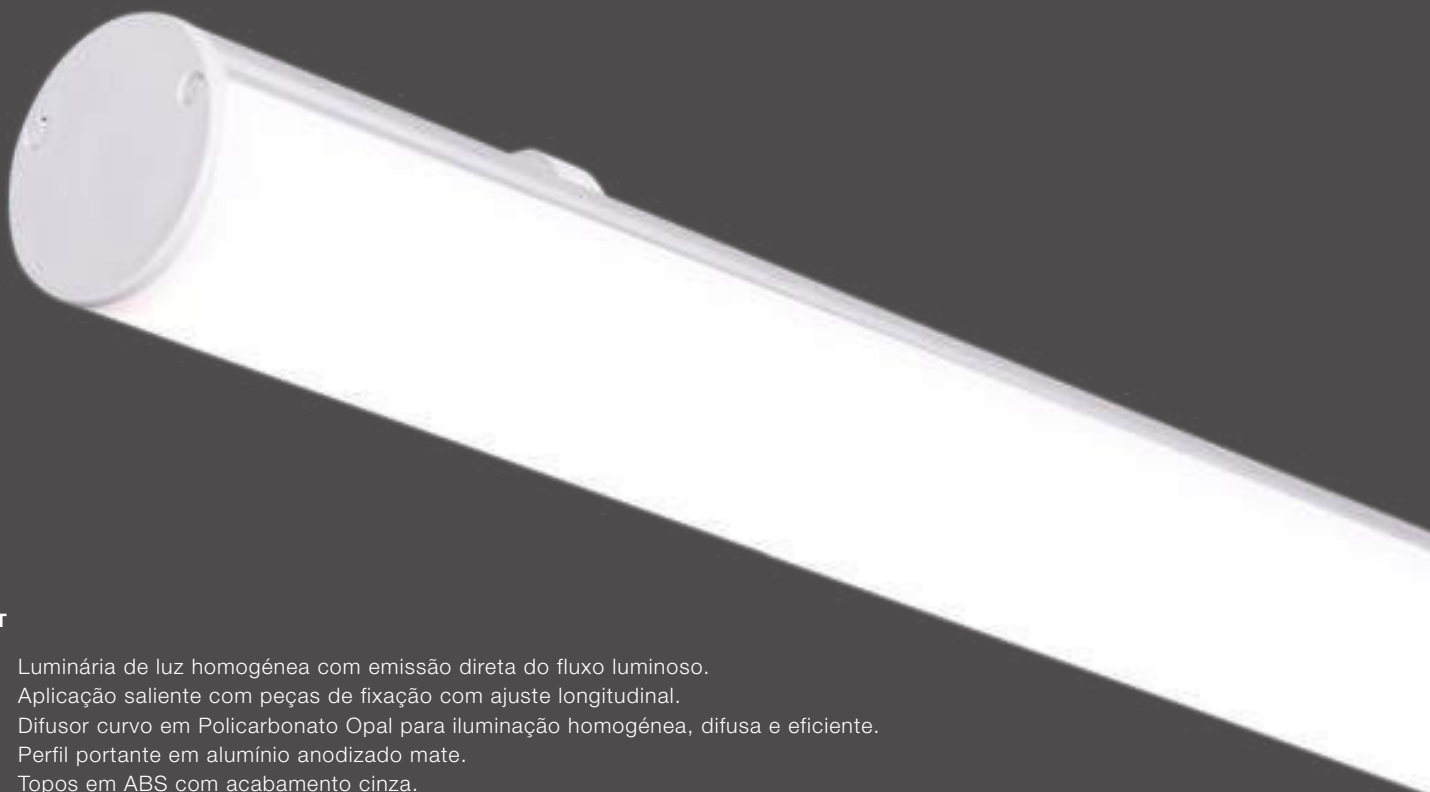

### PT

- > Luminária de luz homogénea com emissão direta do fluxo luminoso.
- > Aplicação saliente com peças de fixação com ajuste longitudinal.
- > Difusor curvo em Policarbonato Opal para iluminação homogénea, difusa e eficiente.
- > Perfil portante em alumínio anodizado mate.
- > Topos em ABS com acabamento cinza.

### ES

- > Luminaria de luz homogénea con emisión directa del flujo luminoso.
- > De aplicación en superficie por soportes de fijación con ajuste longitudinal.
- > Difusor curvo en Policarbonato Opal.
- > Perfil soporte fabricado en aluminio anodizado mate.
- > Tapas finales en ABS acabado gris.



**QUICK INFO**

**GENERAL**

Surface  
IP40  
IK07  
850°C  
Class I  
Ta= -20°C +35°C

**OPTIC**

Opal Polycarbonate

**LED**

Efficacy up to 171 lm/W  
3000 K, 4000 K  
CRI >80  
Lifetime 72 000 H  
L80/B10 @Tc=65°C

**ELETRICAL SYSTEM**

230V/50Hz  
ON/OFF, DALI

**FINISHING**

Matt Anodized

**OPTIONS**

**LED**

2700 K, 5000 K, 6500 K  
Tunable White, RGB, RGBW  
CRI >90

**ELECTRICAL SYSTEM**

DSI, DIM 1-10V, Phase-cut

**CONTROL SYSTEM**

Bluetooth

**FINISHING**

 Other Colours

**EMERGENCY**

1 Hour, 3 Hours  
DALI 1 Hour, 3 Hours

**SENSORS**

Motion  
Ambient Light  
Motion & Ambient Light

**TUPOLI-V 70 SURFACE**

**OPAL DIFFUSER**

c (mm)	Output (lm)	System (W)	ON/OFF	DALI
<b>3000 K</b>				
868	2177	19	33.49.004.08.32	33.49.004.08.42
	4353	38	33.49.004.08.33	33.49.004.08.43
1149	2901	25	33.49.004.08.34	33.49.004.08.44
	5805	50	33.49.004.08.35	33.49.004.08.45
1430	3627	31	33.49.004.08.36	33.49.004.08.46
	7255	63	33.49.004.08.37	33.49.004.08.47
2273	5803	50	33.49.004.08.38	33.49.004.08.48
	11609	101	33.49.004.08.39	33.49.004.08.49
2835	7254	63	33.49.004.08.40	33.49.004.08.50
	14511	126	33.49.004.08.41	33.49.004.08.51
<b>4000 K</b>				
868	2278	19	33.49.004.08.52	33.49.004.08.62
	4555	38	33.49.004.08.53	33.49.004.08.63
1149	3037	25	33.49.004.08.54	33.49.004.08.64
	6073	50	33.49.004.08.55	33.49.004.08.65
1430	3796	31	33.49.004.08.56	33.49.004.08.66
	7591	63	33.49.004.08.57	33.49.004.08.67
2273	6073	50	33.49.004.08.58	33.49.004.08.68
	12146	101	33.49.004.08.59	33.49.004.08.69
2835	7592	63	33.49.004.08.60	33.49.004.08.70
	15183	126	33.49.004.08.61	33.49.004.08.71

> Fluorescent lamp versions also available – product data at [www.climarlighting.com](http://www.climarlighting.com) – or by direct request to the factory.

**OPTIONS**

**EMERGENCY (EM) - SELF-TEST INTEGRATED**

ON/OFF	COD
EM 1H 3W	35.00.003.01.23*

DALI	COD
EM 1H 5,4W DALI	35.00.004.01.54*

\* Applies to lengths equal to or greater than 1430 mm.  
> On request – External Emergency. Box dimensions: 45x120x360 mm.

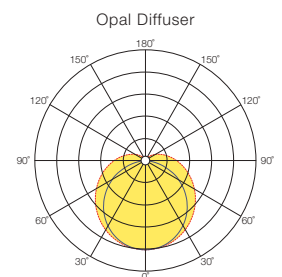
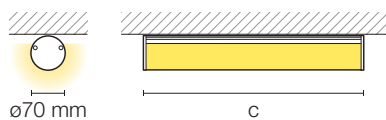

# TUPOLI-360 70

## SUSPENDED

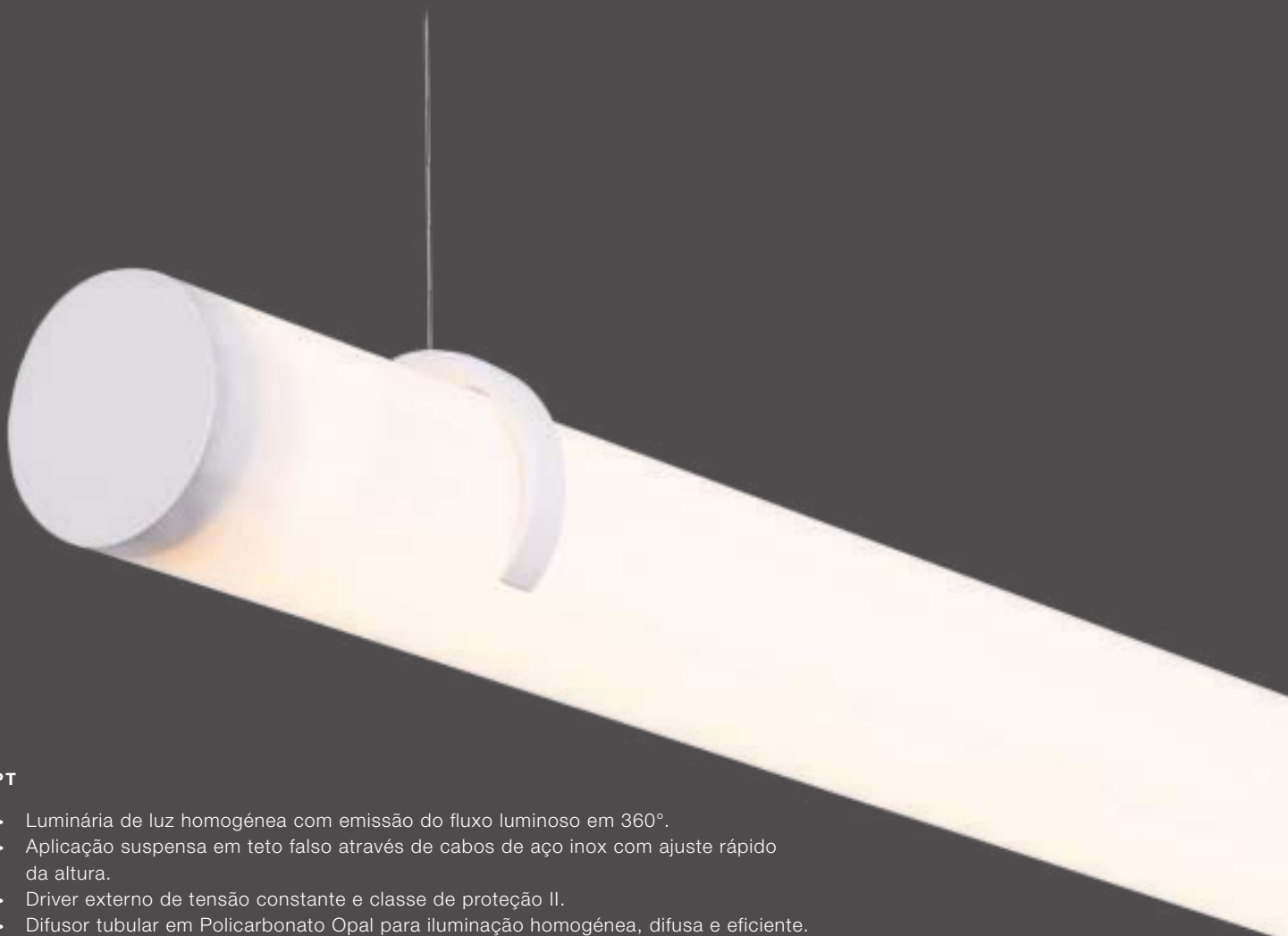

### PT

- > Luminária de luz homogénea com emissão do fluxo luminoso em 360°.
- > Aplicação suspensa em teto falso através de cabos de aço inox com ajuste rápido da altura.
- > Driver externo de tensão constante e classe de proteção II.
- > Difusor tubular em Policarbonato Opal para iluminação homogénea, difusa e eficiente.
- > Refletor interno em alumínio para maior desempenho da luminária.
- > Topos em alumínio com acabamento branco mate e sem parafusos visíveis.

### ES

- > Luminaria de luz homogénea con emisión luminosa en 360°.
- > Aplicación suspendida en falso techo por cables de acero inoxidable con regulación de la altura.
- > Driver externo de tensión constante y clase de protección II.
- > Difusor tubular en Policarbonato Opal.
- > Reflector interno en aluminio para aumentar el rendimiento de la luminaria.
- > Tapas finales en aluminio con acabado blanco mate y sin tornillos visibles.

**QUICK INFO**

**GENERAL**

Suspended  
 IP40  
 IK08  
 850°C  
 Class III  
 Ta= -20°C +35°C

**OPTIC**

Opal Polycarbonate

**LED**

Efficacy up to 141 lm/W  
 3000 K, 4000 K  
 CRI >80  
 Lifetime 50 000 H  
 L80/B10 @Tc=55°C  
 24 VDC

**ELETRICAL SYSTEM**

230V/50Hz  
 ON/OFF, DALI

**OPTIONS**

**LED**

2700 K, 5000 K, 6500 K  
 Tunable White, RGB, RGBW  
 CRI >90

**ELECTRICAL SYSTEM**

DSI, DIM 1-10V, Phase-cut

**CONTROL SYSTEM**

Bluetooth

**SENSORS**

Motion  
 Ambient Light  
 Motion & Ambient Light

**TUPOLI-360 70 SUSPENDED**

**OPAL DIFFUSER**

c (mm)	Output (lm)	LED Power (W)	LED Voltage	COD
<b>3000 K</b>				
574	824	8	24 VDC	33.49.004.08.20
1074	1648	16	24 VDC	33.49.004.08.21
1574	2472	23	24 VDC	33.49.004.08.22
<b>4000 K</b>				
574	824	7	24 VDC	33.49.004.08.26
1074	1648	15	24 VDC	33.49.004.08.27
1574	2472	22	24 VDC	33.49.004.08.28

**COMPONENTS**

**SUSPENSION SYSTEM (2pcs)**



TYPE	1m	3m	5m
Matt White	35.49.003.01.48	35.49.003.01.49	35.49.002.08.76

**RECESSED CEILING CUP (1pc)**



TYPE	1m	3m	5m
Matt White Ø80 mm	35.49.001.08.31	35.49.002.08.63	35.49.002.08.71

**DRIVER - EXTERNAL**



CLASS II

ON/OFF	DIMENSION	COD
Power Supply 4-32W IP20	21x40x220 mm	35.00.003.01.75
Power Supply 6-49W IP20	21x40x250 mm	35.00.003.01.74
Power Supply 12-86W IP20	21x40x300 mm	35.00.003.01.73
DALI	DIMENSION	COD
Power Supply 12-90W IP20	30x43x295 mm	35.00.003.01.76
Power Supply 18-135W IP20	31x43x325 mm	35.00.003.01.77

> External Driver to be housed nearby.

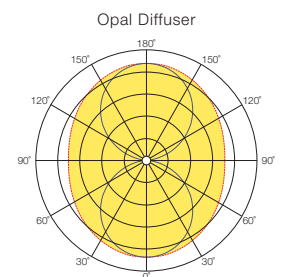
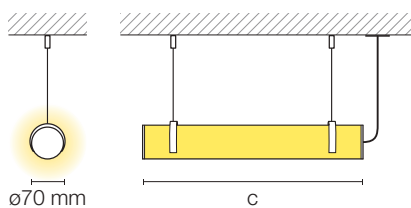



> TUPOLI-360 70 SUSPENDED

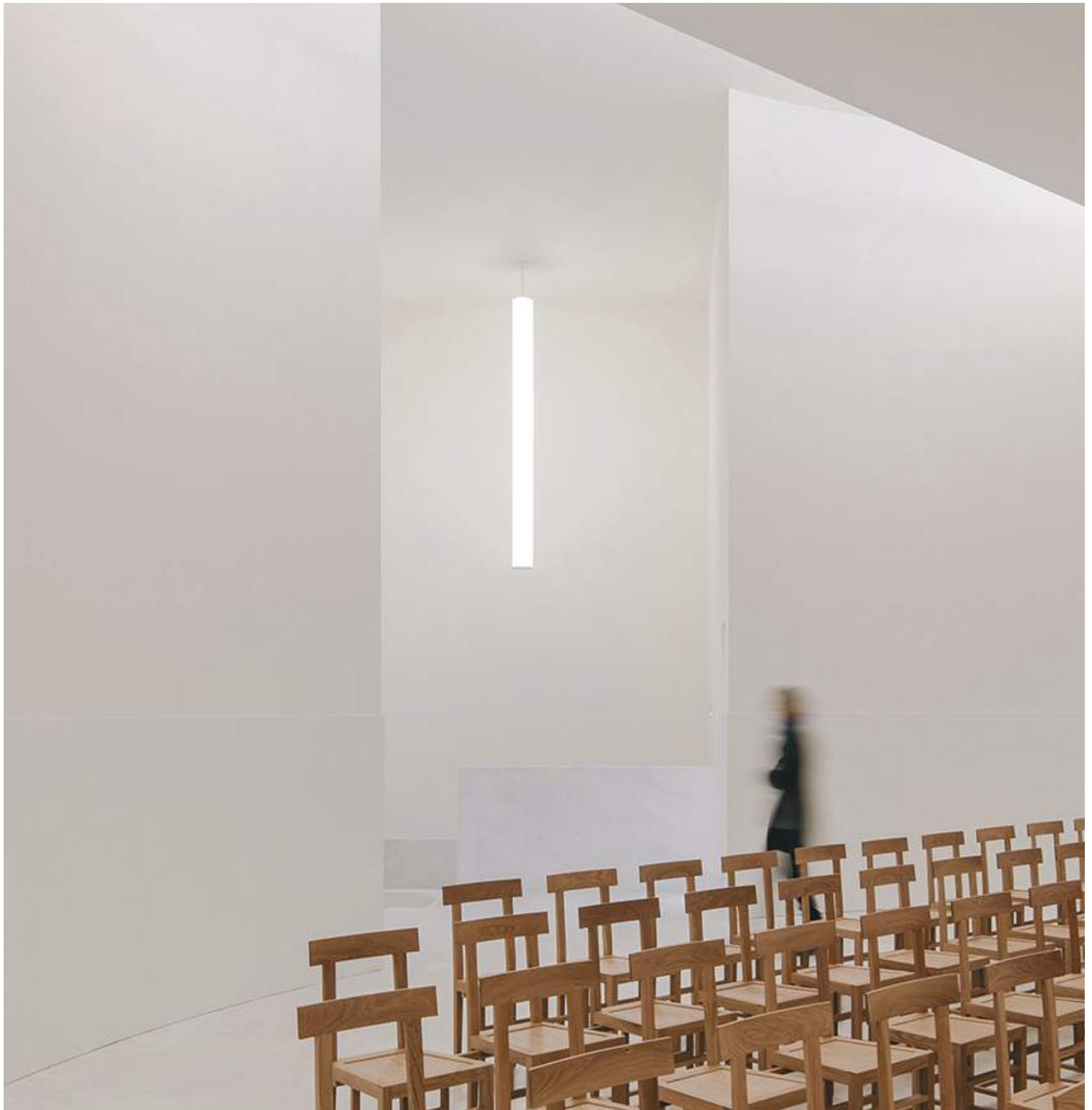

> TUPOLI-360 70 VERTICAL SUSPENDED

# TUPOLI-360 70 VERTICAL SUSPENDED



## PT

- > Luminária de luz homogénea com emissão do fluxo luminoso em 360°.
- > Aplicação suspensa em teto falso através de cabo de aço inox com ajuste rápido da altura.
- > Driver externo de tensão constante e classe de proteção II.
- > Difusor tubular em Policarbonato Opal para iluminação homogénea, difusa e eficiente.
- > Refletor interno em alumínio para maior desempenho da luminária.
- > Topos em alumínio com acabamento branco mate e sem parafusos visíveis.

## ES

- > Luminaria de luz homogénea con emisión luminosa en 360°.
- > Aplicación suspendida en falso techo por cable de acero inoxidable con regulación de la altura.
- > Driver externo de tensión constante y clase de protección II.
- > Difusor tubular en Policarbonato Opal.
- > Reflector interno en aluminio para aumentar el rendimiento de la luminaria.
- > Tapas finales en aluminio con acabado blanco mate y sin tornillos visibles.

**QUICK INFO**

**GENERAL**

Suspended  
 IP40  
 IK08  
 850°C  
 Class III  
 Ta= -20°C +35°C

**OPTIC**

Opal Polycarbonate

**LED**

Efficacy up to 141 lm/W  
 3000 K, 4000 K  
 CRI >80  
 Lifetime 50 000 H  
 L80/B10 @Tc=55°C  
 24 VDC

**ELETRICAL SYSTEM**

230V/50Hz  
 ON/OFF, DALI

**OPTIONS**

**LED**

2700 K, 5000 K, 6500 K  
 Tunable White, RGB, RGBW  
 CRI >90

**ELECTRICAL SYSTEM**

DSI, DIM 1-10V, Phase-cut

**CONTROL SYSTEM**

Bluetooth

**SENSORS**

Motion  
 Ambient Light  
 Motion & Ambient Light

**TUPOLI-360 70 VERTICAL SUSPENDED  
 OPAL DIFFUSER**

c (mm)	Output (lm)	LED Power (W)	LED Voltage	COD
<b>3000 K</b>				
574	824	8	24 VDC	33.49.004.08.08
1074	1648	16	24 VDC	33.49.004.08.09
1574	2472	23	24 VDC	33.49.004.08.10
<b>4000 K</b>				
574	824	7	24 VDC	33.49.004.08.14
1074	1648	15	24 VDC	33.49.004.08.15
1574	2472	22	24 VDC	33.49.004.08.16

**COMPONENTS**



**SUSPENSION SYSTEM (1pc)**

TYPE	1 m	3 m	5 m
Matt White	35.42.001.01.77	35.42.001.01.78	35.42.001.01.79



**RECESSED CEILING CUP (1pc)**

TYPE	1 m	3 m	5 m
Matt White Ø80 mm	35.49.001.08.31	35.49.002.08.63	35.49.002.08.71



**DRIVER - EXTERNAL**

CLASS II

ON/OFF	DIMENSION	COD
Power Supply 4-32W IP20	21x40x220 mm	35.00.003.01.75
Power Supply 6-49W IP20	21x40x250 mm	35.00.003.01.74
Power Supply 12-86W IP20	21x40x300 mm	35.00.003.01.73
DALI	DIMENSION	COD
Power Supply 12-90W IP20	30x43x295 mm	35.00.003.01.76
Power Supply 18-135W IP20	31x43x325 mm	35.00.003.01.77

> External Driver to be housed nearby.

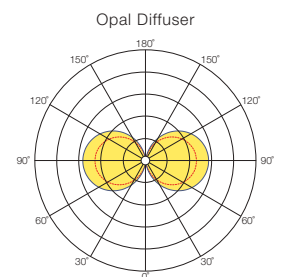
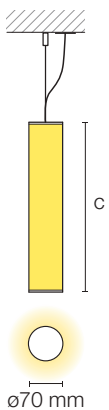

VON LINEAR  
TRIMLESS



OUR BESPOKE  
PROJECTS

Our bespoke projects are designed to meet your specific needs and requirements. We offer a range of services, including design, construction, and installation. Our team of experts will work closely with you to ensure that your project is completed to the highest standards of quality and craftsmanship.







> VON C-LIGHT & DOUBLE SPOT SURFACE

# VON, A MODULAR CONCEPT. OVERVIEW

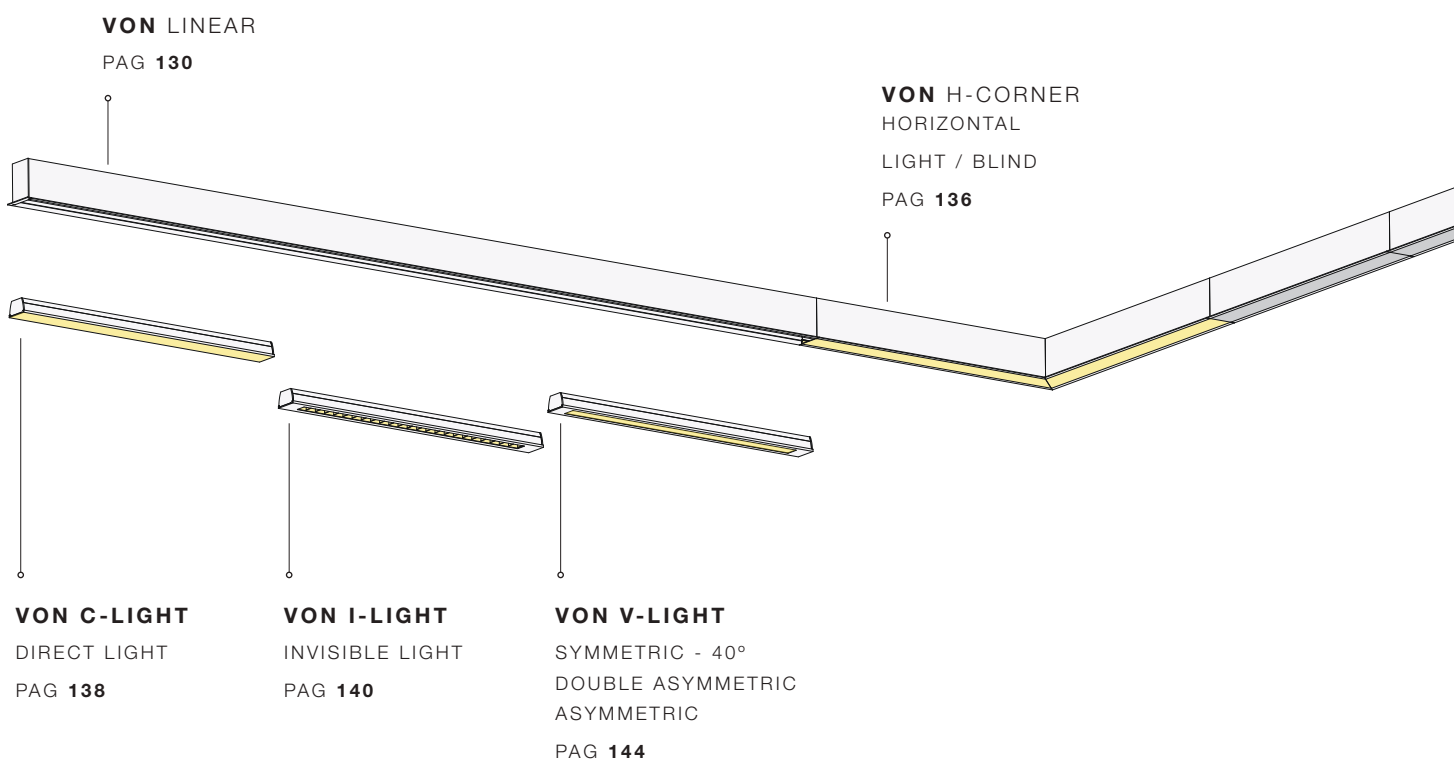

**VON V-CORNER**  
VERTICAL  
LIGHT / BLIND  
PAG 137

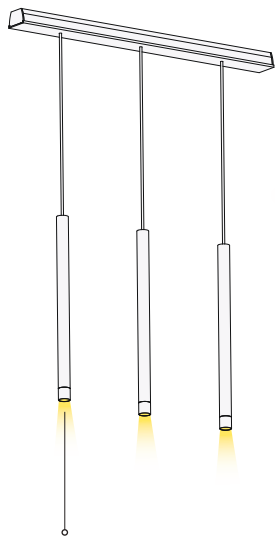

**VON TUBE**  
PAG 152

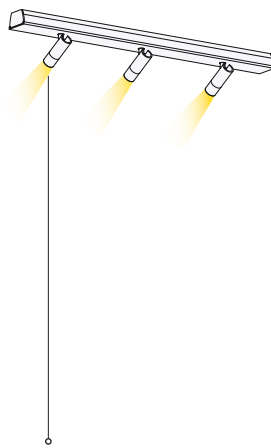

**VON SPOT**  
PAG 148

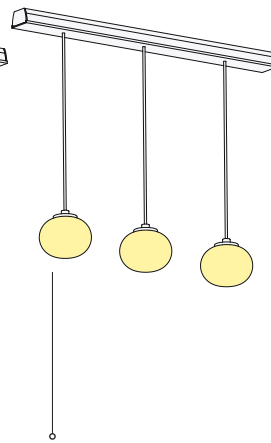

**VON GLOBE S**  
PAG 160

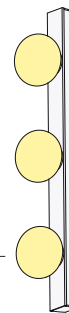

**VON GLOBE**  
PAG 156



**BLIND COVER**  
PAG 164

# VON

## A MODULAR CONCEPT

### PT

- > Sistema de perfis estruturais para alojar módulos iluminação VON.
- > Desenvolvidos para formar linhas contínuas de aplicação saliente, suspensa ou encastrada com e sem aba de remate (trimless).
- > Disponíveis cantos 90° com e sem iluminação que permitem mudanças de direção horizontal ou vertical.
- > Os perfis estruturais podem alojar diferentes módulos VON para criar a iluminação ideal em cada espaço.
- > Os módulos de iluminação podem ser retirados, trocados de posição e reinstalados no perfil estrutural com apenas um clique.
- > Perfis pré-cabados com sistema de conexão elétrica rápida.
- > Corpo em alumínio com acabamento texturado.

### ES

- > Sistema de perfiles estructurales para alojar los módulos de iluminación VON.
- > Desarrollados para formar líneas continuas de instalación en superficie, suspendida o empotrada con y sin marco (trimless).
- > Disponibles esquinas 90° con y sin iluminación que permiten cambios de dirección horizontal o vertical.
- > Los perfiles estructurales pueden alojar distintos módulos VON para crear la iluminación ideal en cualquier espacio.
- > Los módulos de iluminación se pueden quitar, cambiar de posición y re-instalar en el perfil estructural con un simple clic.
- > Perfiles precableados con sistema de conexión eléctrica rápida.
- > Cuerpo en aluminio con acabado texturado.

**QUICK INFO****GENERAL**

Suspended / Surface  
Recessed / Trimless  
IP20

**ELECTRICAL SYSTEM**

230V/50Hz  
ON/OFF, DALI

**FINISHING**

RAL 9003 Textured White  
RAL 9005 Textured Black

**OPTIONS****FINISHING**

 Other Colours

**VON LINEAR**

- > PRE-WIRED PROFILES;
- > PLUG & PLAY SYSTEM;
- > EASY ASSEMBLY.

# VON LINEAR SUSPENDED

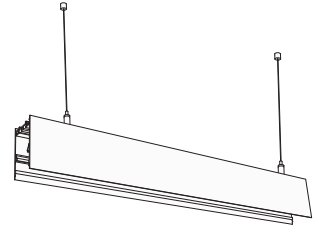

## VON SUSPENDED LINEAR

c (mm)	WHITE	BLACK
641	35.42.90.00.004	35.42.90.00.000
1281	35.42.90.00.005	35.42.90.00.001
1921	35.42.90.00.006	35.42.90.00.002
2561	35.42.90.00.007	35.42.90.00.003

## COMPONENTS

	<b>END CAP (1pc)</b>		WHITE	BLACK
	End Cap		35.42.90.00.601	35.42.90.00.602
	<b>SURFACE CEILING CUP (1pc)</b>			
	WHITE	DIMENSION	1 m	3 m
ON/OFF, DALI	Ø62x36 mm	35.42.90.00.606	35.42.90.00.607	35.42.90.00.608
	<b>RECESSED CEILING CUP (1pc)</b>			
	WHITE	DIMENSION	1 m	3 m
ON/OFF, DALI	Ø80 mm	35.42.90.00.609	35.42.90.00.610	35.42.90.00.611
	<b>SUSPENSION SYSTEM (2pcs)</b>			
	TYPE	1 m	3 m	5 m
	Matt White + Stainless Steel Cable	35.42.90.00.603	35.42.90.00.604	35.42.90.00.605
Matt Black + Stainless Steel Cable	35.42.90.00.612	35.42.90.00.613	35.42.90.00.614	
	<b>LINEAR COUPLER (1pc)</b>		COD	
	Coupler		35.42.90.00.600	

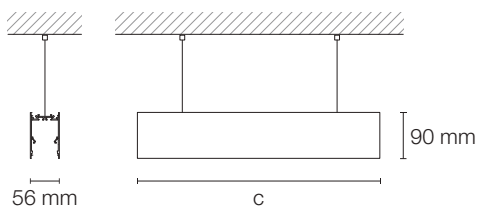

# VON LINEAR SURFACE

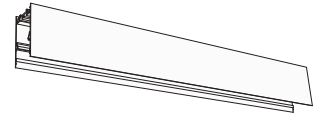

## VON SURFACE LINEAR

c (mm)	WHITE	BLACK
641	35.42.90.10.004	35.42.90.10.000
1281	35.42.90.10.005	35.42.90.10.001
1921	35.42.90.10.006	35.42.90.10.002
2561	35.42.90.10.007	35.42.90.10.003

## COMPONENTS



### END CAP (1pc)

	WHITE	BLACK
End Cap	35.42.90.00.601	35.42.90.00.602



### LINEAR COUPLER (1pc)

	COD
Coupler	35.42.90.00.600

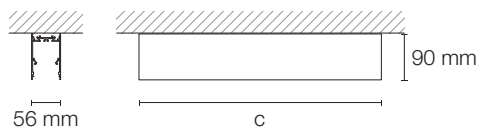

# VON LINEAR RECESSED / TRIMLESS

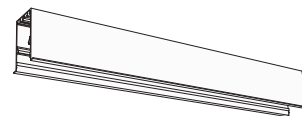

## VON RECESSED LINEAR



c (mm)	WHITE	BLACK
641	35.42.90.20.004	35.42.90.20.000
1281	35.42.90.20.005	35.42.90.20.001
1921	35.42.90.20.006	35.42.90.20.002
2561	35.42.90.20.007	35.42.90.20.003



## VON TRIMLESS LINEAR

c (mm)	WHITE
641	35.42.90.30.004
1281	35.42.90.30.005
1921	35.42.90.30.006
2561	35.42.90.30.007

## COMPONENTS

	<b>RECESSED END CAP (1pc)</b>	<b>WHITE</b>	<b>BLACK</b>
	End Cap	35.42.90.20.601	35.42.90.20.602
	<b>TRIMLESS END CAP (1pc)</b>	<b>WHITE</b>	
	End Cap	35.42.90.30.600	
	<b>LINEAR COUPLER (1pc)</b>	<b>COD</b>	
	Coupler	35.42.90.20.600	

### VON RECESSED



### VON TRIMLESS

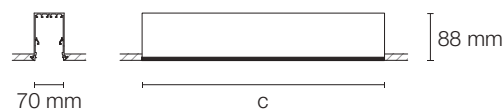





# VON H-CORNER HORIZONTAL

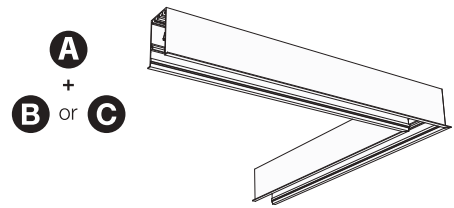

## A PROFILE H-CORNER 90°

Type	WHITE	BLACK
Suspended	35.42.90.00.466	35.42.90.00.467
Surface	35.42.90.10.008	35.42.90.10.009
Recessed	35.42.90.20.010	35.42.90.20.011
Trimless	35.42.90.30.010	35.42.90.30.011

## B LIGHT H-CORNER 90°

Output (lm)	System (W)	ON/OFF	DALI
<b>2700 K</b>			
2033	21	35.42.90.00.470	35.42.90.00.471
3955	45	35.42.90.00.460	35.42.90.00.461
<b>3000 K</b>			
2093	21	35.42.90.00.472	35.42.90.00.473
4078	45	35.42.90.00.462	35.42.90.00.463
<b>4000 K</b>			
2192	21	35.42.90.00.474	35.42.90.00.475
4266	45	35.42.90.00.464	35.42.90.00.465

## C BLIND H-CORNER 90°

Type	WHITE	BLACK
Blind Cover H-Corner	35.42.90.00.446	35.42.90.00.452

SUSPENDED / SURFACE

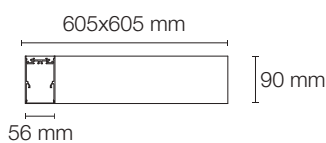

RECESSED

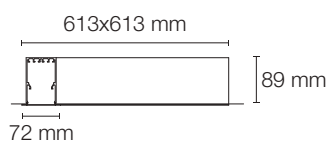

TRIMLESS

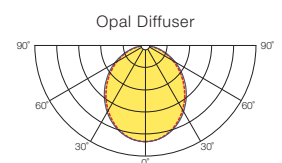
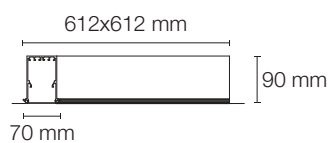

# VON V-CORNER VERTICAL

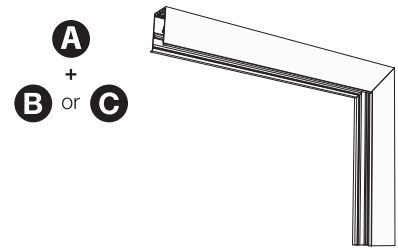

## A PROFILE V-CORNER 90°

Type	WHITE	BLACK
Recessed	35.42.90.20.008	35.42.90.20.009
Trimless	35.42.90.30.008	35.42.90.30.009

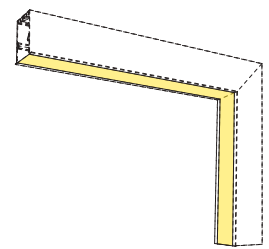

## B LIGHT V-CORNER 90°

Output (lm)	System (W)	ON/OFF	DALI
<b>2700 K</b>			
2033	21	35.42.90.00.476	35.42.90.00.477
3955	45	35.42.90.00.454	35.42.90.00.455
<b>3000 K</b>			
2093	21	35.42.90.00.478	35.42.90.00.479
4078	45	35.42.90.00.456	35.42.90.00.457
<b>4000 K</b>			
2192	21	35.42.90.00.480	35.42.90.00.481
4266	45	35.42.90.00.458	35.42.90.00.459

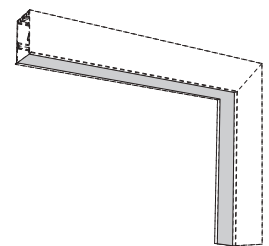

## C BLIND V-CORNER 90°

Type	WHITE	BLACK
Blind Cover V-Corner	35.42.90.00.447	35.42.90.00.453

RECESSED

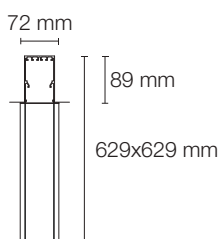

TRIMLESS

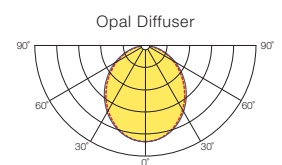
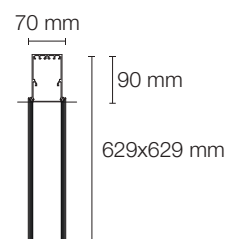

# VON C-LIGHT DIRECT LIGHT MODULE



## PT

- > Módulo de luz direta com difusor para distribuição uniforme do fluxo luminoso.
- > Desenvolvido para integração nos perfis VON de aplicação saliente, suspensa ou encastrada com e sem aba de remate (trimless).
- > Os módulos são fixos em segurança ao perfil estrutural com apenas um clique.
- > O sistema de conexão elétrica rápida simplifica a instalação e alterações de posição dos módulos.
- > Difusor Policarbonato Opal para iluminação homogénea, difusa e eficiente.
- > Corpo em alumínio com acabamento texturado.

## ES

- > Módulo de luz directa con difusor para distribución uniforme del flujo luminoso.
- > Diseñado para la integración en los perfiles VON de instalación en superficie, suspendida o empotrada con y sin marco.
- > Los módulos se fijan de forma segura al perfil estructural con un simple clic.
- > El sistema de conexión eléctrica rápida simplifica el montaje y los cambios de posición de los módulos.
- > Difusor Policarbonato Opal.
- > Cuerpo en aluminio con acabado texturado.

VON C-LIGHT

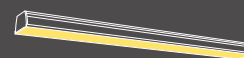

**QUICK INFO**

**GENERAL**

Module  
 IP20  
 850°C  
 Class I  
 Ta= -20°C +35°C

**OPTIC**

Opal Polycarbonate

**LED**

Efficacy up to 193 lm/W  
 2700 K, 3000 K, 4000 K  
 CRI >80  
 Lifetime 72 000 H  
 L80/B10 @TC=65°C

**ELETRICAL SYSTEM**

230V/50Hz  
 ON/OFF, DALI

**FINISHING**

RAL 9003 Textured White

**OPTIONS**

**LED**

5000 K, 6500 K  
 RGB, RGBW

**ELECTRICAL SYSTEM**

DSI, DIM 1-10V

**CONTROL SYSTEM**

Bluetooth

**SENSORS**

Motion  
 Ambient Light  
 Motion & Ambient Light

**VON C-LIGHT MODULE**

**OPAL DIFFUSER**

**MATT WHITE FINISHING**

c (mm)	Output (lm)	System (W)	ON/OFF	DALI
<b>2700 K</b>				
640	929	11	35.42.90.00.012	35.42.90.00.016
	1776	22	35.42.90.00.013	35.42.90.00.017
1280	1859	22	35.42.90.00.014	35.42.90.00.018
	3551	45	35.42.90.00.015	35.42.90.00.019
<b>3000 K</b>				
640	1077	11	35.42.90.00.020	35.42.90.00.024
	2059	22	35.42.90.00.021	35.42.90.00.025
1280	2154	22	35.42.90.00.022	35.42.90.00.026
	4118	45	35.42.90.00.023	35.42.90.00.027
<b>4000 K</b>				
640	1127	11	35.42.90.00.028	35.42.90.00.032
	2154	22	35.42.90.00.029	35.42.90.00.033
1280	2254	22	35.42.90.00.030	35.42.90.00.468
	4309	45	35.42.90.00.031	35.42.90.00.469

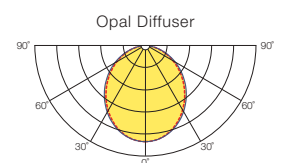
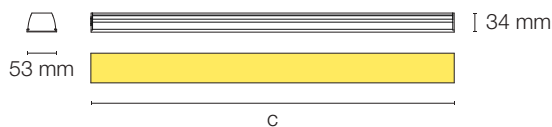

# VON I-LIGHT

INVISIBLE LIGHT - UGR <13

## MODULE



### PT

- > Módulo de luz invisível com excecional controlo do encandeamento.
- > Desenvolvido para integração nos perfis VON de aplicação saliente, suspensa ou encastrada com e sem aba de remate (trimless).
- > A fonte de luz é invisível, proporcionando elevado conforto visual com UGR <13 para máxima proteção anti-encandeamento.
- > A ótica com lente integrada permite ângulos de abertura de 16°, 40° ou 35°x12° (elíptica).
- > Os módulos são fixos em segurança ao perfil estrutural com apenas um clique.
- > O sistema de conexão elétrica rápida simplifica a instalação e alterações de posição dos módulos.
- > Corpo em alumínio com acabamento texturado.

VON I-LIGHT 12

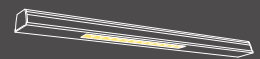

### ES

- > Módulo de luz invisible con excelente control del deslumbramiento.
- > Diseñado para la integración en los perfiles VON de instalación en superficie, suspendida o empotrada con y sin marco.
- > La fuente de luz es invisible, ofreciendo un elevado confort visual con UGR <13 para máxima protección anti deslumbramiento.
- > La óptica con lente integrada permite ángulos de emisión de 16°, 40° o 35°x12° (elíptica).
- > Los módulos se fijan de forma segura al perfil estructural con un simple clic.
- > El sistema de conexión eléctrica rápida simplifica el montaje y los cambios de posición de los módulos.
- > Cuerpo en aluminio con acabado texturado.

VON I-LIGHT 24

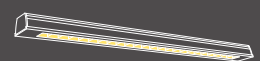

**QUICK INFO**

**GENERAL**

Module  
 IP20  
 650°C  
 Class I  
 Ta= -20°C +35°C

**OPTIC**

Clear PMMA Lens  
 UGR <13

**LED**

Efficacy up to 103 lm/W  
 2700 K, 3000 K, 4000 K  
 CRI >90  
 Lifetime 80 000 H  
 L80/B10 @Tc=65°C

**ELETRICAL SYSTEM**

230V/50Hz  
 ON/OFF, DALI

**FINISHING**

RAL 9003 Textured White  
 RAL 9005 Textured Black

**OPTIONS**

**LED**

5000 K, 6500 K  
 RGB, RGBW

**ELECTRICAL SYSTEM**

DSI, DIM 1-10V

**CONTROL SYSTEM**

Bluetooth

**FINISHING**

 Other Colours

**SENSORS**

Motion  
 Ambient Light  
 Motion & Ambient Light

**VON I-LIGHT 12 MODULE**

**MATT WHITE FINISHING**

Beam Angle (°)	Output (lm)	System (W)	ON/OFF	DALI
<b>2700 K</b>				
16°	1179	13	35.42.90.00.043	35.42.90.00.047
40°	1183	13	35.42.90.00.044	35.42.90.00.048
Elliptical 35°x12°	1066	13	35.42.90.00.045	35.42.90.00.049
<b>3000 K</b>				
16°	1179	13	35.42.90.00.059	35.42.90.00.063
40°	1183	13	35.42.90.00.060	35.42.90.00.064
Elliptical 35°x12°	1066	13	35.42.90.00.061	35.42.90.00.065
<b>4000 K</b>				
16°	1238	13	35.42.90.00.075	35.42.90.00.079
40°	1242	13	35.42.90.00.076	35.42.90.00.080
Elliptical 35°x12°	1120	13	35.42.90.00.077	35.42.90.00.081

**MATT BLACK FINISHING**

c (mm)	Output (lm)	System (W)	ON/OFF	DALI
<b>2700 K</b>				
16°	1179	13	35.42.90.00.035	35.42.90.00.039
40°	1183	13	35.42.90.00.036	35.42.90.00.040
Elliptical 35°x12°	1066	13	35.42.90.00.037	35.42.90.00.041
<b>3000 K</b>				
16°	1179	13	35.42.90.00.051	35.42.90.00.055
40°	1183	13	35.42.90.00.052	35.42.90.00.056
Elliptical 35°x12°	1066	13	35.42.90.00.053	35.42.90.00.057
<b>4000 K</b>				
16°	1238	13	35.42.90.00.067	35.42.90.00.071
40°	1242	13	35.42.90.00.068	35.42.90.00.072
Elliptical 35°x12°	1120	13	35.42.90.00.069	35.42.90.00.073

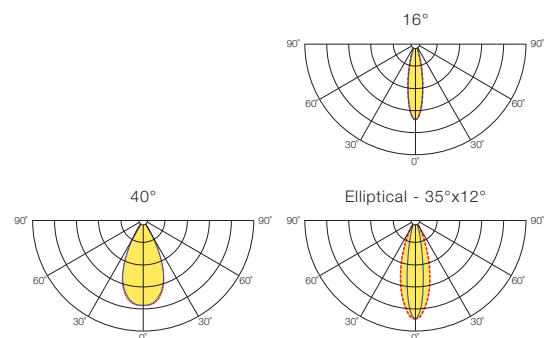
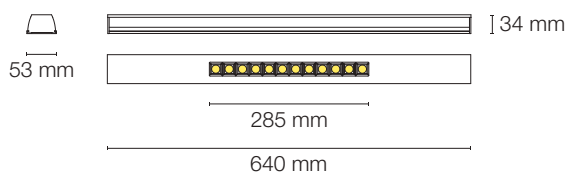

**QUICK INFO**

**GENERAL**

Module  
 IP20  
 650°C  
 Class I  
 Ta= -20°C +35°C

**OPTIC**

Clear PMMA Lens  
 UGR <13

**LED**

Efficacy up to 103 lm/W  
 2700 K, 3000 K, 4000 K  
 CRI >90  
 Lifetime 80 000 H  
 L80/B10 @Tc=65°C

**ELETRICAL SYSTEM**

230V/50Hz  
 ON/OFF, DALI

**FINISHING**

RAL 9003 Textured White  
 RAL 9005 Textured Black

**OPTIONS**

**LED**

5000 K, 6500 K  
 RGB, RGBW

**ELECTRICAL SYSTEM**

DSI, DIM 1-10V

**CONTROL SYSTEM**

Bluetooth

**FINISHING**

Other Colours

**SENSORS**

Motion  
 Ambient Light  
 Motion & Ambient Light

**VON I-LIGHT 24 MODULE**

**MATT WHITE FINISHING**

Beam Angle (°)	Output (lm)	System (W)	ON/OFF	DALI
<b>2700 K</b>				
16°	2358	27	35.42.90.00.091	35.42.90.00.095
40°	2365	27	35.42.90.00.092	35.42.90.00.096
35°x12°	2133	27	35.42.90.00.093	35.42.90.00.097
<b>3000 K</b>				
16°	2358	27	35.42.90.00.107	35.42.90.00.111
40°	2365	27	35.42.90.00.108	35.42.90.00.112
35°x12°	2133	27	35.42.90.00.109	35.42.90.00.113
<b>4000 K</b>				
16°	2477	27	35.42.90.00.123	35.42.90.00.127
40°	2485	27	35.42.90.00.124	35.42.90.00.128
35°x12°	2240	27	35.42.90.00.125	35.42.90.00.129

**MATT BLACK FINISHING**

c (mm)	Output (lm)	System (W)	ON/OFF	DALI
<b>2700 K</b>				
16°	2358	27	35.42.90.00.083	35.42.90.00.087
40°	2365	27	35.42.90.00.084	35.42.90.00.088
35°x12°	2133	27	35.42.90.00.085	35.42.90.00.089
<b>3000 K</b>				
16°	2358	27	35.42.90.00.099	35.42.90.00.103
40°	2365	27	35.42.90.00.100	35.42.90.00.104
35°x12°	2133	27	35.42.90.00.101	35.42.90.00.105
<b>4000 K</b>				
16°	2477	27	35.42.90.00.115	35.42.90.00.119
40°	2485	27	35.42.90.00.116	35.42.90.00.120
35°x12°	2240	27	35.42.90.00.117	35.42.90.00.121

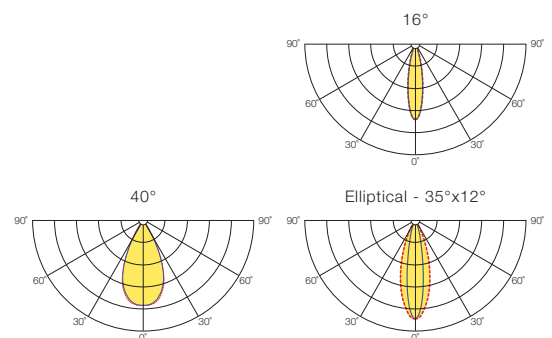
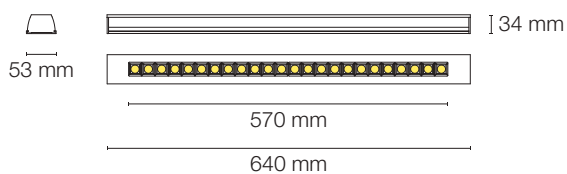





# VON V-LIGHT

SYMMETRIC / ASYMMETRIC

## MODULE



### PT

- > Módulo de luz direta com lente linear para rigoroso controlo do feixe de luz.
- > Desenvolvido para integração nos perfis VON de aplicação saliente, suspensa ou encastrada com e sem aba de remate (trimless).
- > Lentes lineares de elevada eficiência com opção de distribuição de luz simétrica, assimétrica ou dupla-assimétrica.
- > Os módulos são fixos em segurança ao perfil estrutural com apenas um clique.
- > O sistema de conexão elétrica rápida simplifica a instalação e alterações de posição dos módulos.
- > Corpo em alumínio com acabamento texturado.

### ES

- > Módulo de luz directa con lente linear para un control preciso de haz.
- > Diseñado para la integración en los perfiles VON de instalación en superficie, suspendida o empotrada con y sin marco.
- > Lentes lineares de alta eficiencia con opción de distribución de luz simétrica, asimétrica o doble asimétrica.
- > Los módulos se fijan de forma segura al perfil estructural con un simple clic.
- > El sistema de conexión eléctrica rápida simplifica el montaje y los cambios de posición de los módulos.
- > Cuerpo en aluminio con acabado texturado.

VON V-LIGHT

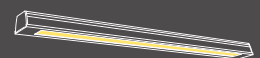

**QUICK INFO**

**GENERAL**

Module  
 IP20  
 650°C  
 Class I  
 Ta= -20°C +35°C

**OPTIC**

Clear PMMA Lens

**LED**

Efficacy up to 161 lm/W  
 2700 K, 3000 K, 4000 K  
 CRI >90  
 Lifetime 72 000 H  
 L80/B10 @TC=65°C

**ELETRICAL SYSTEM**

230V/50Hz  
 ON/OFF, DALI

**FINISHING**

RAL 9003 Textured White

**OPTIONS**

**LED**

5000 K, 6500 K  
 RGB, RGBW

**ELECTRICAL SYSTEM**

DSI, DIM 1-10V

**CONTROL SYSTEM**

Bluetooth

**FINISHING**

 Other Colours

**SENSORS**

Motion  
 Ambient Light  
 Motion & Ambient Light

**VON V-LIGHT MODULE**

**MATT WHITE FINISHING**

Beam Angle (°)	Output (lm)	System (W)	ON/OFF	DALI
<b>2700 K</b>				
Symmetric 40°	1201	12	35.42.90.00.144	35.42.90.00.150
	2476	25	35.42.90.00.147	35.42.90.00.153
Double Asymmetric	1215	12	35.42.90.00.143	35.42.90.00.149
	2503	25	35.42.90.00.146	35.42.90.00.152
Asymmetric	1151	12	35.42.90.00.142	35.42.90.00.148
	2373	25	35.42.90.00.145	35.42.90.00.151
<b>3000 K</b>				
Symmetric 40°	1372	12	35.42.90.00.168	35.42.90.00.174
	2589	25	35.42.90.00.171	35.42.90.00.177
Double Asymmetric	1387	12	35.42.90.00.167	35.42.90.00.173
	2617	25	35.42.90.00.170	35.42.90.00.176
Asymmetric	1315	12	35.42.90.00.166	35.42.90.00.172
	2481	25	35.42.90.00.169	35.42.90.00.175
<b>4000 K</b>				
Symmetric 40°	1432	12	35.42.90.00.192	35.42.90.00.198
	2702	25	35.42.90.00.195	35.42.90.00.201
Double Asymmetric	1448	12	35.42.90.00.191	35.42.90.00.197
	2732	25	35.42.90.00.194	35.42.90.00.200
Asymmetric	1373	12	35.42.90.00.190	35.42.90.00.196
	2589	25	35.42.90.00.193	35.42.90.00.199

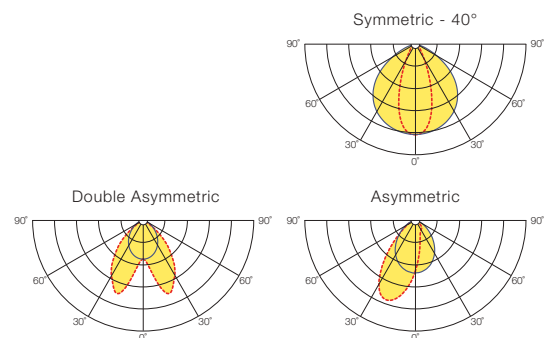
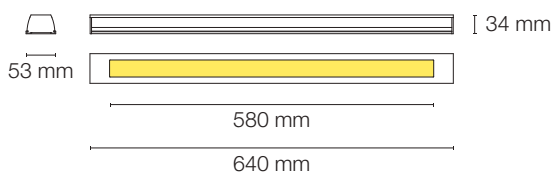

**QUICK INFO**

**GENERAL**

Module  
 IP20  
 650°C  
 Class I  
 Ta= -20°C +35°C

**OPTIC**

Clear PMMA Lens

**LED**

Efficacy up to 161 lm/W  
 2700 K, 3000 K, 4000 K  
 CRI >90  
 Lifetime 72 000 H  
 L80/B10 @TC=65°C

**ELETRICAL SYSTEM**

230V/50Hz  
 ON/OFF, DALI

**FINISHING**

RAL 9005 Textured Black

**OPTIONS**

**LED**

5000 K, 6500 K  
 RGB, RGBW

**ELECTRICAL SYSTEM**

DSI, DIM 1-10V

**CONTROL SYSTEM**

Bluetooth

**FINISHING**

 Other Colours

**SENSORS**

Motion  
 Ambient Light  
 Motion & Ambient Light

**VON V-LIGHT MODULE**

**MATT BLACK FINISHING**

Beam Angle (°)	Output (lm)	System (W)	ON/OFF	DALI
<b>2700 K</b>				
Symmetric 40°	1201	12	35.42.90.00.132	35.42.90.00.138
	2476	25	35.42.90.00.135	35.42.90.00.141
Double Asymmetric	1215	12	35.42.90.00.131	35.42.90.00.137
	2503	25	35.42.90.00.134	35.42.90.00.140
Asymmetric	1151	12	35.42.90.00.130	35.42.90.00.136
	2373	25	35.42.90.00.133	35.42.90.00.139
<b>3000 K</b>				
Symmetric 40°	1372	12	35.42.90.00.156	35.42.90.00.162
	2589	25	35.42.90.00.159	35.42.90.00.165
Double Asymmetric	1387	12	35.42.90.00.155	35.42.90.00.161
	2617	25	35.42.90.00.158	35.42.90.00.164
Asymmetric	1315	12	35.42.90.00.154	35.42.90.00.160
	2481	25	35.42.90.00.157	35.42.90.00.163
<b>4000 K</b>				
Symmetric 40°	1432	12	35.42.90.00.180	35.42.90.00.186
	2702	25	35.42.90.00.183	35.42.90.00.189
Double Asymmetric	1448	12	35.42.90.00.179	35.42.90.00.185
	2732	25	35.42.90.00.182	35.42.90.00.188
Asymmetric	1373	12	35.42.90.00.178	35.42.90.00.184
	2589	25	35.42.90.00.181	35.42.90.00.187

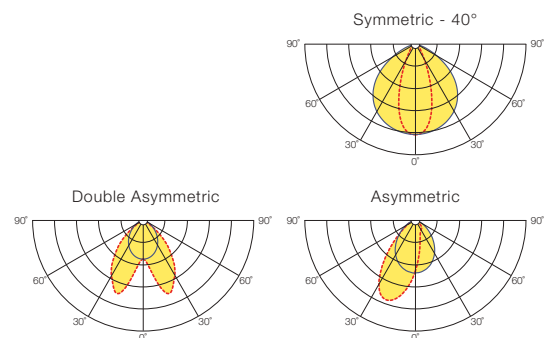
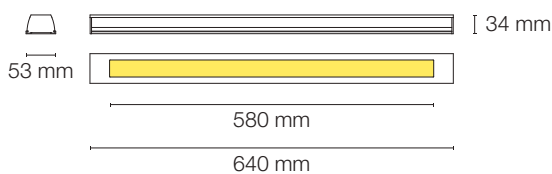



# VON SPOT MODULE



## PT

- > Módulo de mini projetores orientáveis.
- > Desenvolvido para integração nos perfis VON de aplicação saliente, suspensa ou encastrada com e sem aba de remate (trimless).
- > Projetores orientáveis em 355° de rotação e 90° de inclinação.
- > A ótica com lente integrada permite ângulos de abertura de 30° ou 60°.
- > Os módulos são fixos em segurança ao perfil estrutural com apenas um clique.
- > O sistema de conexão elétrica rápida simplifica a instalação e alterações de posição dos módulos.
- > Corpo e projetores em alumínio com acabamento texturado.

VON DOUBLE SPOT

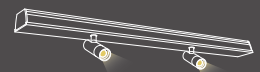

## ES

- > Módulo de mini proyectores orientables.
- > Diseñado para la integración en los perfiles VON de instalación en superficie, suspendida o empotrada con y sin marco.
- > Proyectores orientables con rotación de 355° y basculación de 90°.
- > La óptica con lente integrada permite ángulos de emisión de 30° o 60°.
- > Los módulos se fijan de forma segura al perfil estructural con un simple clic.
- > El sistema de conexión eléctrica rápida simplifica el montaje y los cambios de posición de los módulos.
- > Cuerpo y proyectores en aluminio con acabado texturado.

VON TRIPLE SPOT

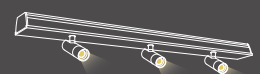

**QUICK INFO**

**GENERAL**

Module  
 IP20  
 650°C  
 Class I  
 Ta= -20°C +35°C

**OPTIC**

Clear PMMA Lens

**LED**

Efficacy up to 129 lm/W  
 2700 K, 3000 K, 4000 K  
 CRI >90  
 Lifetime 80 000 H  
 L80/B10 @TC=65°C

**ELETRICAL SYSTEM**

230V/50Hz  
 ON/OFF, DALI

**FINISHING**

RAL 9003 Textured White  
 RAL 9005 Textured Black

**OPTIONS**

**LED**

5000 K, 6500 K  
 RGB, RGBW

**ELECTRICAL SYSTEM**

DSI, DIM 1-10V

**CONTROL SYSTEM**

Bluetooth

**FINISHING**

 Other Colours

**SENSORS**

Motion  
 Ambient Light  
 Motion & Ambient Light

**ROTATION**

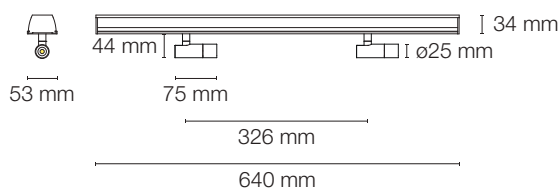
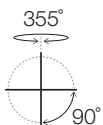

**VON DOUBLE SPOT MODULE**

**MATT WHITE FINISHING**

Beam Angle (°)	Output (lm)	System (W)	ON/OFF	DALI
<b>2700 K</b>				
30°	572	10	35.42.90.00.259	35.42.90.00.263
60°	539	10	35.42.90.00.261	35.42.90.00.265
<b>3000 K</b>				
30°	617	10	35.42.90.00.275	35.42.90.00.279
60°	583	10	35.42.90.00.277	35.42.90.00.281
<b>4000 K</b>				
30°	664	10	35.42.90.00.291	35.42.90.00.295
60°	627	10	35.42.90.00.293	35.42.90.00.297

**MATT BLACK FINISHING**

c (mm)	Output (lm)	System (W)	ON/OFF	DALI
<b>2700 K</b>				
30°	572	10	35.42.90.00.251	35.42.90.00.255
60°	539	10	35.42.90.00.253	35.42.90.00.257
<b>3000 K</b>				
30°	617	10	35.42.90.00.267	35.42.90.00.271
60°	583	10	35.42.90.00.269	35.42.90.00.273
<b>4000 K</b>				
30°	664	10	35.42.90.00.283	35.42.90.00.287
60°	627	10	35.42.90.00.285	35.42.90.00.289

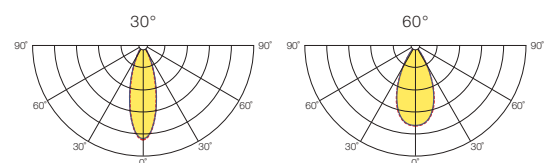

**QUICK INFO**

**GENERAL**

Module  
 IP20  
 650°C  
 Class I  
 Ta= -20°C +35°C

**OPTIC**

Clear PMMA Lens

**LED**

Efficacy up to 129 lm/W  
 2700 K, 3000 K, 4000 K  
 CRI >90  
 Lifetime 80 000 H  
 L80/B10 @TC=65°C

**ELETRICAL SYSTEM**

230V/50Hz  
 ON/OFF, DALI

**FINISHING**

RAL 9003 Textured White  
 RAL 9005 Textured Black

**OPTIONS**

**LED**

5000 K, 6500 K  
 RGB, RGBW

**ELECTRICAL SYSTEM**

DSI, DIM 1-10V

**CONTROL SYSTEM**

Bluetooth

**FINISHING**

 Other Colours

**SENSORS**

Motion  
 Ambient Light  
 Motion & Ambient Light

ROTATION

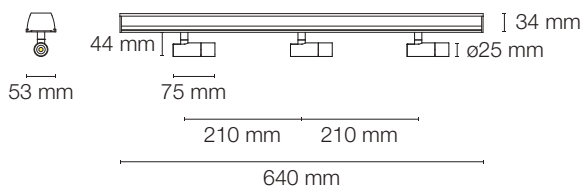
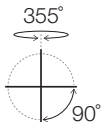

**VON TRIPLE SPOT MODULE**

**MATT WHITE FINISHING**

Beam Angle (°)	Output (lm)	System (W)	ON/OFF	DALI
<b>2700 K</b>				
30°	808	15	35.42.90.00.211	35.42.90.00.215
60°	776	15	35.42.90.00.213	35.42.90.00.217
<b>3000 K</b>				
30°	872	15	35.42.90.00.227	35.42.90.00.231
60°	838	15	35.42.90.00.229	35.42.90.00.233
<b>4000 K</b>				
30°	938	15	35.42.90.00.243	35.42.90.00.247
60°	902	15	35.42.90.00.245	35.42.90.00.249

**MATT BLACK FINISHING**

c (mm)	Output (lm)	System (W)	ON/OFF	DALI
<b>2700 K</b>				
30°	808	15	35.42.90.00.203	35.42.90.00.207
60°	776	15	35.42.90.00.205	35.42.90.00.209
<b>3000 K</b>				
30°	872	15	35.42.90.00.219	35.42.90.00.223
60°	838	15	35.42.90.00.221	35.42.90.00.225
<b>4000 K</b>				
30°	938	15	35.42.90.00.235	35.42.90.00.239
60°	902	15	35.42.90.00.237	35.42.90.00.241

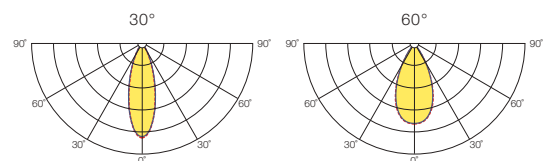





# VON TUBE MODULE



## PT

- > Módulo de luminárias tubulares suspensas.
- > Desenvolvido para integração nos perfis VON de aplicação saliente, suspensa ou encastrada com e sem aba de remate (trimless).
- > A ótica com lente integrada permite ângulos de abertura de 30° ou 60°.
- > Os módulos são fixos em segurança ao perfil estrutural com apenas um clique.
- > O sistema de conexão elétrica rápida simplifica a instalação e alterações de posição dos módulos.
- > Corpo e tubos em alumínio com acabamento texturado.

## ES

- > Módulo de luminarias tubulares suspendidas.
- > Diseñado para la integración en los perfiles VON de instalación en superficie, suspendida o empotrada con y sin marco.
- > La óptica con lente integrada permite ángulos de emisión de 30° o 60°.
- > Los módulos se fijan de forma segura al perfil estructural con un simple clic.
- > El sistema de conexión eléctrica rápida simplifica el montaje y los cambios de posición de los módulos.
- > Cuerpo y tubos en aluminio con acabado texturado.

VON DOUBLE TUBE



VON TRIPLE TUBE

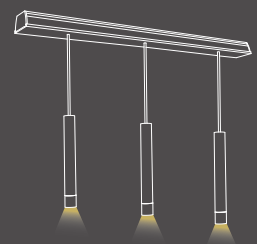

**QUICK INFO**

**GENERAL**

Module  
 IP20  
 650°C  
 Class I  
 Ta= -20°C +35°C

**OPTIC**

Clear PMMA Lens

**LED**

Efficacy up to 129 lm/W  
 2700 K, 3000 K, 4000 K  
 CRI >90  
 Lifetime 80 000 H  
 L80/B10 @TC=65°C

**ELETRICAL SYSTEM**

230V/50Hz  
 ON/OFF, DALI

**FINISHING**

RAL 9003 Textured White  
 RAL 9005 Textured Black

**OPTIONS**

**LED**

5000 K, 6500 K  
 RGB, RGBW

**ELECTRICAL SYSTEM**

DSI, DIM 1-10V

**CONTROL SYSTEM**

Bluetooth

**FINISHING**

 Other Colours

**SENSORS**

Motion  
 Ambient Light  
 Motion & Ambient Light

**VON DOUBLE TUBE MODULE**

**MATT WHITE FINISHING**

Beam Angle (°)	Output (lm)	System (W)	ON/OFF	DALI
<b>2700 K</b>				
30°	572	10	35.42.90.00.355	35.42.90.00.359
60°	539	10	35.42.90.00.357	35.42.90.00.361
<b>3000 K</b>				
30°	617	10	35.42.90.00.371	35.42.90.00.375
60°	583	10	35.42.90.00.373	35.42.90.00.377
<b>4000 K</b>				
30°	664	10	35.42.90.00.387	35.42.90.00.391
60°	627	10	35.42.90.00.389	35.42.90.00.393

**MATT BLACK FINISHING**

c (mm)	Output (lm)	System (W)	ON/OFF	DALI
<b>2700 K</b>				
30°	572	10	35.42.90.00.347	35.42.90.00.351
60°	539	10	35.42.90.00.349	35.42.90.00.353
<b>3000 K</b>				
30°	617	10	35.42.90.00.363	35.42.90.00.367
60°	583	10	35.42.90.00.365	35.42.90.00.369
<b>4000 K</b>				
30°	664	10	35.42.90.00.379	35.42.90.00.383
60°	627	10	35.42.90.00.381	35.42.90.00.385

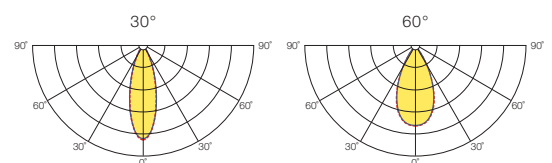
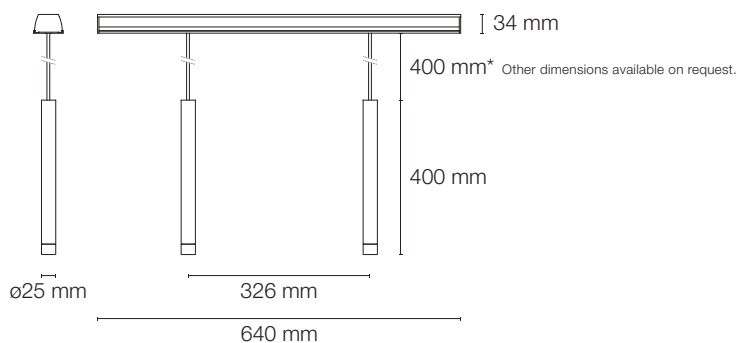

**QUICK INFO**

**GENERAL**

Module  
 IP20  
 650°C  
 Class I  
 Ta= -20°C +35°C

**OPTIC**

Clear PMMA Lens

**LED**

Efficacy up to 129 lm/W  
 2700 K, 3000 K, 4000 K  
 CRI >90  
 Lifetime 80 000 H  
 L80/B10 @TC=65°C

**ELETRICAL SYSTEM**

230V/50Hz  
 ON/OFF, DALI

**FINISHING**

RAL 9003 Textured White  
 RAL 9005 Textured Black

**OPTIONS**

**LED**

5000 K, 6500 K  
 RGB, RGBW

**ELECTRICAL SYSTEM**

DSI, DIM 1-10V

**CONTROL SYSTEM**

Bluetooth

**FINISHING**

 Other Colours

**SENSORS**

Motion  
 Ambient Light  
 Motion & Ambient Light

**VON TRIPLE TUBE MODULE**

**MATT WHITE FINISHING**

Beam Angle (°)	Output (lm)	System (W)	ON/OFF	DALI
<b>2700 K</b>				
30°	808	15	35.42.90.00.307	35.42.90.00.311
60°	776	15	35.42.90.00.309	35.42.90.00.313
<b>3000 K</b>				
30°	872	15	35.42.90.00.323	35.42.90.00.327
60°	838	15	35.42.90.00.325	35.42.90.00.329
<b>4000 K</b>				
30°	938	15	35.42.90.00.339	35.42.90.00.343
60°	902	15	35.42.90.00.341	35.42.90.00.345

**MATT BLACK FINISHING**

c (mm)	Output (lm)	System (W)	ON/OFF	DALI
<b>2700 K</b>				
30°	808	15	35.42.90.00.299	35.42.90.00.303
60°	776	15	35.42.90.00.301	35.42.90.00.305
<b>3000 K</b>				
30°	872	15	35.42.90.00.315	35.42.90.00.319
60°	838	15	35.42.90.00.317	35.42.90.00.321
<b>4000 K</b>				
30°	938	15	35.42.90.00.331	35.42.90.00.335
60°	902	15	35.42.90.00.333	35.42.90.00.337

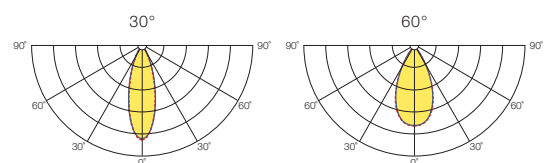
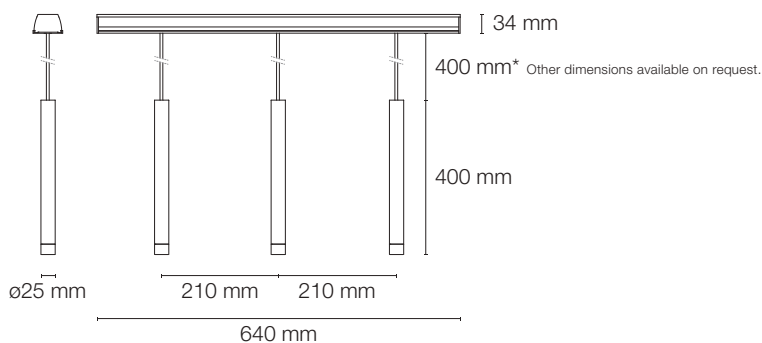



# VON GLOBE MODULE



## PT

- > Módulo com globos em vidro para iluminação difusa.
- > Desenvolvido para integração nos perfis VON de aplicação saliente, suspensa ou encastrada com e sem aba de remate (trimless).
- > Os módulos são fixos em segurança ao perfil estrutural com apenas um clique.
- > O sistema de conexão elétrica rápida simplifica a instalação e alterações de posição dos módulos.
- > Globos em vidro Opal.
- > Corpo em alumínio com acabamento texturado.

VON DOUBLE GLOBE

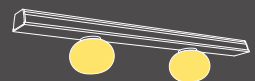

## ES

- > Módulo con globos en cristal que ofrecen una luz difusa.
- > Diseñado para la integración en los perfiles VON de instalación en superficie, suspendida o empotrada con y sin marco.
- > Los módulos se fijan de forma segura al perfil estructural con un simple clic.
- > El sistema de conexión eléctrica rápida simplifica el montaje y los cambios de posición de los módulos.
- > Globos de cristal Opal.
- > Cuerpo en aluminio con acabado texturado.

VON TRIPLE GLOBE

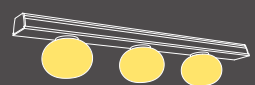

**QUICK INFO**

**GENERAL**

Module  
 IP20  
 960°C  
 Class I  
 Ta= -20°C +35°C

**OPTIC**

Opal Glass

**LED**

Efficacy up to 129 lm/W  
 2700 K, 3000 K, 4000 K  
 CRI >90  
 Lifetime 80 000 H  
 L80/B10 @TC=65°C

**ELETRICAL SYSTEM**

230V/50Hz  
 ON/OFF, DALI

**FINISHING**

RAL 9003 Textured White  
 RAL 9005 Textured Black

**VON DOUBLE GLOBE MODULE**

**MATT WHITE FINISHING**

Output (lm)	System (W)	ON/OFF	DALI
<b>2700 K</b>			
335	10	35.42.90.00.408	35.42.90.00.409
<b>3000 K</b>			
362	10	35.42.90.00.412	35.42.90.00.413
<b>4000 K</b>			
390	10	35.42.90.00.416	35.42.90.00.417

**MATT BLACK FINISHING**

Output (lm)	System (W)	ON/OFF	DALI
<b>2700 K</b>			
335	10	35.42.90.00.406	35.42.90.00.407
<b>3000 K</b>			
362	10	35.42.90.00.410	35.42.90.00.411
<b>4000 K</b>			
390	10	35.42.90.00.414	35.42.90.00.415

**OPTIONS**

**LED**

5000 K, 6500 K  
 RGB, RGBW

**ELECTRICAL SYSTEM**

DSI, DIM 1-10V

**CONTROL SYSTEM**

Bluetooth

**FINISHING**

 Other Colours

**SENSORS**

Motion  
 Ambient Light  
 Motion & Ambient Light

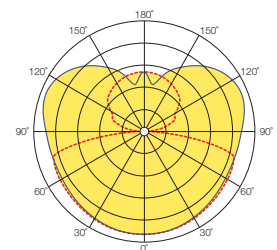
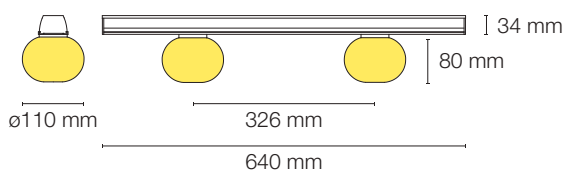

**QUICK INFO**

**GENERAL**

Module  
 IP20  
 960°C  
 Class I  
 Ta= -20°C +35°C

**OPTIC**

Opal Glass

**LED**

Efficacy up to 129 lm/W  
 2700 K, 3000 K, 4000 K  
 CRI >90  
 Lifetime 80 000 H  
 L80/B10 @TC=65°C

**ELECTRICAL SYSTEM**

230V/50Hz  
 ON/OFF, DALI

**FINISHING**

RAL 9003 Textured White  
 RAL 9005 Textured Black

**VON TRIPLE GLOBE MODULE**

**MATT WHITE FINISHING**

Output (lm)	System (W)	ON/OFF	DALI
<b>2700 K</b>			
517	15	35.42.90.00.396	35.42.90.00.397
<b>3000 K</b>			
558	15	35.42.90.00.400	35.42.90.00.401
<b>4000 K</b>			
601	15	35.42.90.00.404	35.42.90.00.405

**MATT BLACK FINISHING**

Output (lm)	System (W)	ON/OFF	DALI
<b>2700 K</b>			
517	15	35.42.90.00.394	35.42.90.00.395
<b>3000 K</b>			
558	15	35.42.90.00.398	35.42.90.00.399
<b>4000 K</b>			
601	15	35.42.90.00.402	35.42.90.00.403

**OPTIONS**

**LED**

5000 K, 6500 K  
 RGB, RGBW

**ELECTRICAL SYSTEM**

DSI, DIM 1-10V

**CONTROL SYSTEM**

Bluetooth

**FINISHING**

 Other Colours

**SENSORS**

Motion  
 Ambient Light  
 Motion & Ambient Light

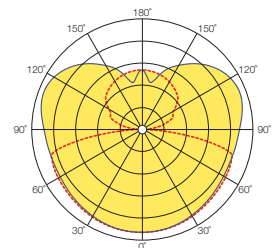
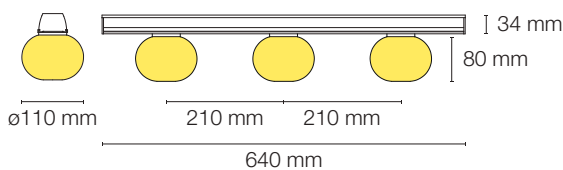





# VON GLOBE S MODULE



## PT

- > Módulo com globos suspensos em vidro para iluminação difusa.
- > Desenvolvido para integração nos perfis VON de aplicação saliente, suspensa ou encastrada com e sem aba de remate (trimless).
- > Os módulos são fixos em segurança ao perfil estrutural com apenas um clique.
- > O sistema de conexão elétrica rápida simplifica a instalação e alterações de posição dos módulos.
- > Globos em vidro Opal.
- > Corpo em alumínio com acabamento texturado.

## ES

- > Módulo con globos suspendidos en cristal que ofrecen una luz difusa.
- > Diseñado para la integración en los perfiles VON de instalación en superficie, suspendida o empotrada con y sin marco.
- > Los módulos se fijan de forma segura al perfil estructural con un simple clic.
- > El sistema de conexión eléctrica rápida simplifica el montaje y los cambios de posición de los módulos.
- > Globos de cristal Opal.
- > Cuerpo en aluminio con acabado texturado.

VON DOUBLE GLOBE S

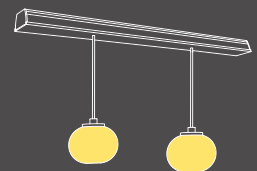

VON TRIPLE GLOBE S

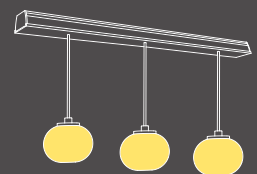

**QUICK INFO**

**GENERAL**

Module  
 IP20  
 750°C  
 Class I  
 Ta= -20°C +35°C

**OPTIC**

Opal Glass

**LED**

Efficacy up to 129 lm/W  
 2700 K, 3000 K, 4000 K  
 CRI >90  
 Lifetime 80 000 H  
 L80/B10 @TC=65°C

**ELECTRICAL SYSTEM**

230V/50Hz  
 ON/OFF, DALI

**FINISHING**

RAL 9003 Textured White  
 RAL 9005 Textured Black

**VON DOUBLE GLOBE MODULE**

**MATT WHITE FINISHING**

Output (lm)	System (W)	ON/OFF	DALI
<b>2700 K</b>			
410	10	35.42.90.00.432	35.42.90.00.433
<b>3000 K</b>			
442	10	35.42.90.00.436	35.42.90.00.437
<b>4000 K</b>			
476	10	35.42.90.00.440	35.42.90.00.441

**MATT BLACK FINISHING**

Output (lm)	System (W)	ON/OFF	DALI
<b>2700 K</b>			
410	10	35.42.90.00.430	35.42.90.00.431
<b>3000 K</b>			
442	10	35.42.90.00.434	35.42.90.00.435
<b>4000 K</b>			
476	10	35.42.90.00.438	35.42.90.00.439

**OPTIONS**

**LED**

5000 K, 6500 K  
 RGB, RGBW

**ELECTRICAL SYSTEM**

DSI, DIM 1-10V

**CONTROL SYSTEM**

Bluetooth

**FINISHING**

 Other Colours

**SENSORS**

Motion  
 Ambient Light  
 Motion & Ambient Light

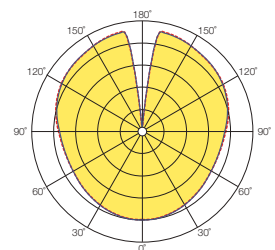
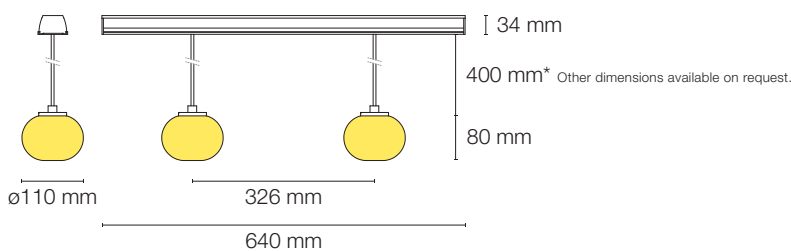

**QUICK INFO**

**GENERAL**

Module  
 IP20  
 750°C  
 Class I  
 Ta= -20°C +35°C

**OPTIC**

Opal Glass

**LED**

Efficacy up to 129 lm/W  
 2700 K, 3000 K, 4000 K  
 CRI >90  
 Lifetime 80 000 H  
 L80/B10 @TC=65°C

**ELECTRICAL SYSTEM**

230V/50Hz  
 ON/OFF, DALI

**FINISHING**

RAL 9003 Textured White  
 RAL 9005 Textured Black

**VON TRIPLE GLOBE MODULE**

**MATT WHITE FINISHING**

Output (lm)	System (W)	ON/OFF	DALI
<b>2700 K</b>			
615	15	35.42.90.00.420	35.42.90.00.421
<b>3000 K</b>			
664	15	35.42.90.00.424	35.42.90.00.425
<b>4000 K</b>			
714	15	35.42.90.00.428	35.42.90.00.429

**MATT BLACK FINISHING**

Output (lm)	System (W)	ON/OFF	DALI
<b>2700 K</b>			
615	15	35.42.90.00.418	35.42.90.00.419
<b>3000 K</b>			
664	15	35.42.90.00.422	35.42.90.00.423
<b>4000 K</b>			
714	15	35.42.90.00.426	35.42.90.00.427

**OPTIONS**

**LED**

5000 K, 6500 K  
 RGB, RGBW

**ELECTRICAL SYSTEM**

DSI, DIM 1-10V

**CONTROL SYSTEM**

Bluetooth

**FINISHING**

 Other Colours

**SENSORS**

Motion  
 Ambient Light  
 Motion & Ambient Light

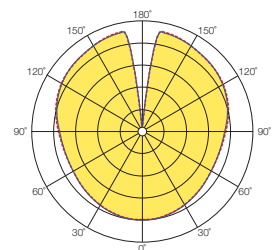
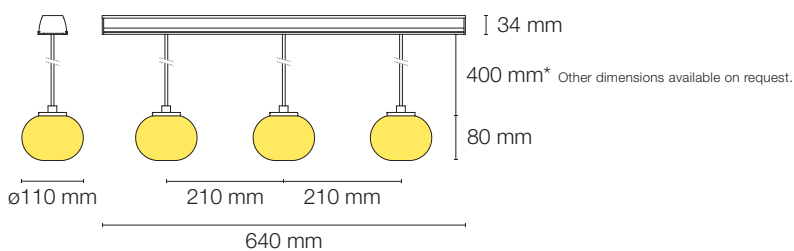



# VON BLIND COVER MODULE



## PT

- > Módulo tampa cega que permite o acabamento uniforme da linha contínua.
- > Para fechar espaços intermédios nos perfis VON de aplicação saliente, suspensa ou encastrada com e sem aba de remate (trimless).
- > As tampas são fixas em segurança ao perfil estrutural com apenas um clique.
- > Em Policarbonato com duas opções de cor e quatro comprimentos pré-definidos.

## ES

- > Módulo de tapa ciega que permite el acabado uniforme de la línea continua.
- > Para cerrar espacios intermedios en los perfiles VON de instalación en superficie, suspendida o empotrada con y sin marco.
- > Las tapas ciegas se fijan de forma segura al perfil estructural con un simple clic.
- > En Policarbonato con dos opciones de color y cuatro longitudes predefinidas.

VON BLIND COVER



**QUICK INFO**

**GENERAL**

Module  
850°C

**FINISHING**

RAL 9003 Textured White  
RAL 9005 Textured Black

**OPTIONS**

**FINISHING**

 Other Colours

**BLIND COVER**

c (mm)	WHITE	BLACK
640	35.42.90.00.442	35.42.90.00.448
1280	35.42.90.00.443	35.42.90.00.449
1920	35.42.90.00.444	35.42.90.00.450
2560	35.42.90.00.445	35.42.90.00.451

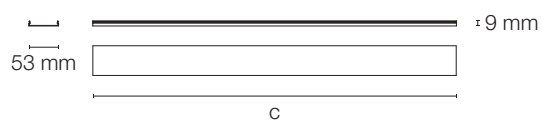







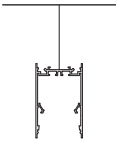

# VON

## ORDER GUIDE

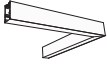
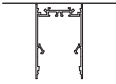
**1** SELECT THE PROFILE

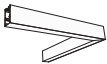
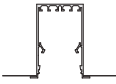
**2** SELECT THE LENGTH / FINISHING

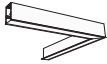
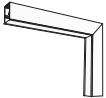
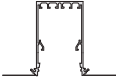
**3** IF NEEDED, SELECT THE **CORNERS**  
HORIZONTAL (H) CORNERS  
VERTICAL (V) CORNERS

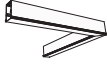
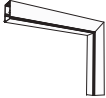
LINEAR		CORNERS	
<p><b>SUSPENDED</b></p> 	<p>641 / 1281 / 1921 / 2561 mm</p> <p><input type="radio"/> White <input checked="" type="radio"/> Black</p> 	<p>605 x 605 mm</p> <p><input type="radio"/> White <input checked="" type="radio"/> Black</p> <p>H-CORNER LIGHT / BLIND</p> 	
<p><b>SURFACE</b></p> 	<p>641 / 1281 / 1921 / 2561 mm</p> <p><input type="radio"/> White <input checked="" type="radio"/> Black</p> 	<p>605 x 605 mm</p> <p><input type="radio"/> White <input checked="" type="radio"/> Black</p> <p>H-CORNER LIGHT / BLIND</p> 	
<p><b>RECESSED</b></p> 	<p>641 / 1281 / 1921 / 2561 mm</p> <p><input type="radio"/> White <input checked="" type="radio"/> Black</p> 	<p>613 x 613 mm</p> <p><input type="radio"/> White <input checked="" type="radio"/> Black</p> <p>H-CORNER LIGHT / BLIND</p> 	<p>629 x 629 mm</p> <p><input type="radio"/> White <input checked="" type="radio"/> Black</p> <p>V-CORNER LIGHT / BLIND</p> 
<p><b>TRIMLESS</b></p> 	<p>641 / 1281 / 1921 / 2561 mm</p> <p><input type="radio"/> White</p> 	<p>612 x 612 mm</p> <p><input type="radio"/> White</p> <p>H-CORNER LIGHT / BLIND</p> 	<p>629 x 629 mm</p> <p><input type="radio"/> White</p> <p>V-CORNER LIGHT / BLIND</p> 



**4** SELECT THE **MODULES**  
(640 mm PER MODULE)

**MODULES**

**C-LIGHT**

White  Black



**I-LIGHT 12**

White  Black



**I-LIGHT 24**

White  Black



**V-LIGHT**

White  Black



**DOUBLE SPOT**

White  Black



**TRIPLE SPOT**

White  Black



**DOUBLE TUBE**

White  Black



**TRIPLE TUBE**

White  Black

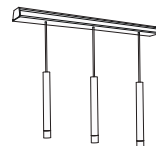

**DOUBLE GLOBE**

White  Black

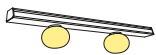

**TRIPLE GLOBE**

White  Black

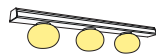

**DOUBLE GLOBE S**

White  Black

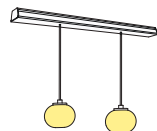

**TRIPLE GLOBE S**

White  Black

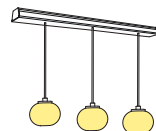

**BLIND COVER**

White  Black



**DROP**  
SUSPENDED





> **DROP** SUSPENDED

# DROP SUSPENDED



## PT

- > Luminária de luz homogénea com emissão direta do fluxo luminoso.
- > Perfil de alumínio compacto (33x75 mm) e design minimalista.
- > De aplicação suspensa por cabos de aço inox com ajuste rápido da altura.
- > Driver externo de tensão constante e classe de proteção II.
- > Difusor PMMA Opal para iluminação homogénea, difusa e eficiente.
- > Corpo em alumínio com revestimento a epoxy-poliéster.

## ES

- > Luminaria de luz homogénea con emisión directa del flujo luminoso.
- > Perfil de aluminio compacto (33x75 mm) con diseño minimalista.
- > De aplicación suspendida por cables de acero inoxidable con regulación de la altura.
- > Driver externo de tensión constante y clase de protección II.
- > Difusor PMMA Opal.
- > Cuerpo en aluminio con recubrimiento epoxi-poliéster.

**QUICK INFO**

**GENERAL**

Suspended  
 IP40  
 750°C  
 Class III  
 Ta= -20°C +35°C

**OPTIC**

PMMA Opal

**LED**

Efficacy up to 124 lm/W  
 3000 K, 4000 K  
 CRI >80  
 Lifetime 60 000 H  
 L70/B10 @TC=65°C  
 24 VDC

**ELETRICAL SYSTEM**

230V/50Hz  
 ON/OFF, DALI

**FINISHING**

RAL 9003 Matt White

**OPTIONS**

**LED**

2700 K, 5000 K, 6500 K  
 Tunable White, RGBW  
 CRI >90

**ELECTRICAL SYSTEM**

DSI, DIM 1-10V, Phase-cut

**CONTROL SYSTEM**

Bluetooth

**FINISHING**

RAL 9005 Matt Black

 Other Colours

**SENSORS**

Motion  
 Ambient Light  
 Motion & Ambient Light

**DROP SUSPENDED**

**OPAL DIFFUSER**

c (mm)	Output (lm)	LED	
		Power (W)	MATT WHITE
<b>3000 K</b>			
1530	984	24	33.41.18.000075
2530	1640	40	33.41.18.000076
<b>4000 K</b>			
1530	984	21	33.41.18.000077
2530	1640	36	33.41.18.000078

**COMPONENTS**

**SUSPENSION SYSTEM (2pcs)**



TYPE	1m	3m	5m
Matt White	35.41.18.000602	35.41.18.000603	35.41.18.000604

**RECESSED CEILING CUP (1pc)**



TYPE	1m	3m	5m
Matt White Ø80 mm	35.41.18.000608	35.41.18.000609	35.41.18.000610

**DRIVER - EXTERNAL**



CLASS II

ON/OFF	DIMENSION	COD
Power Supply 4-32W IP20	21x40x220 mm	35.00.003.01.75
Power Supply 6-49W IP20	21x40x250 mm	35.00.003.01.74
Power Supply 12-86W IP20	21x40x300 mm	35.00.003.01.73
DALI	DIMENSION	COD
Power Supply 12-90W IP20	30x43x295 mm	35.00.003.01.76
Power Supply 18-135W IP20	31x43x325 mm	35.00.003.01.77

> External Driver to be housed nearby.

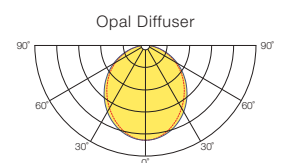
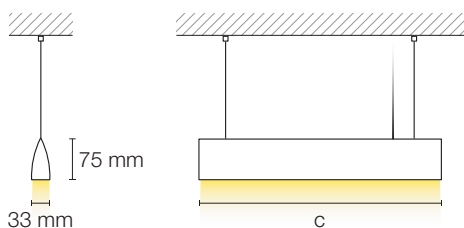

**SNAP**  
SUSPENDED





> **SNAP** SUSPENDED

# SNAP DIRECT LIGHT SUSPENDED

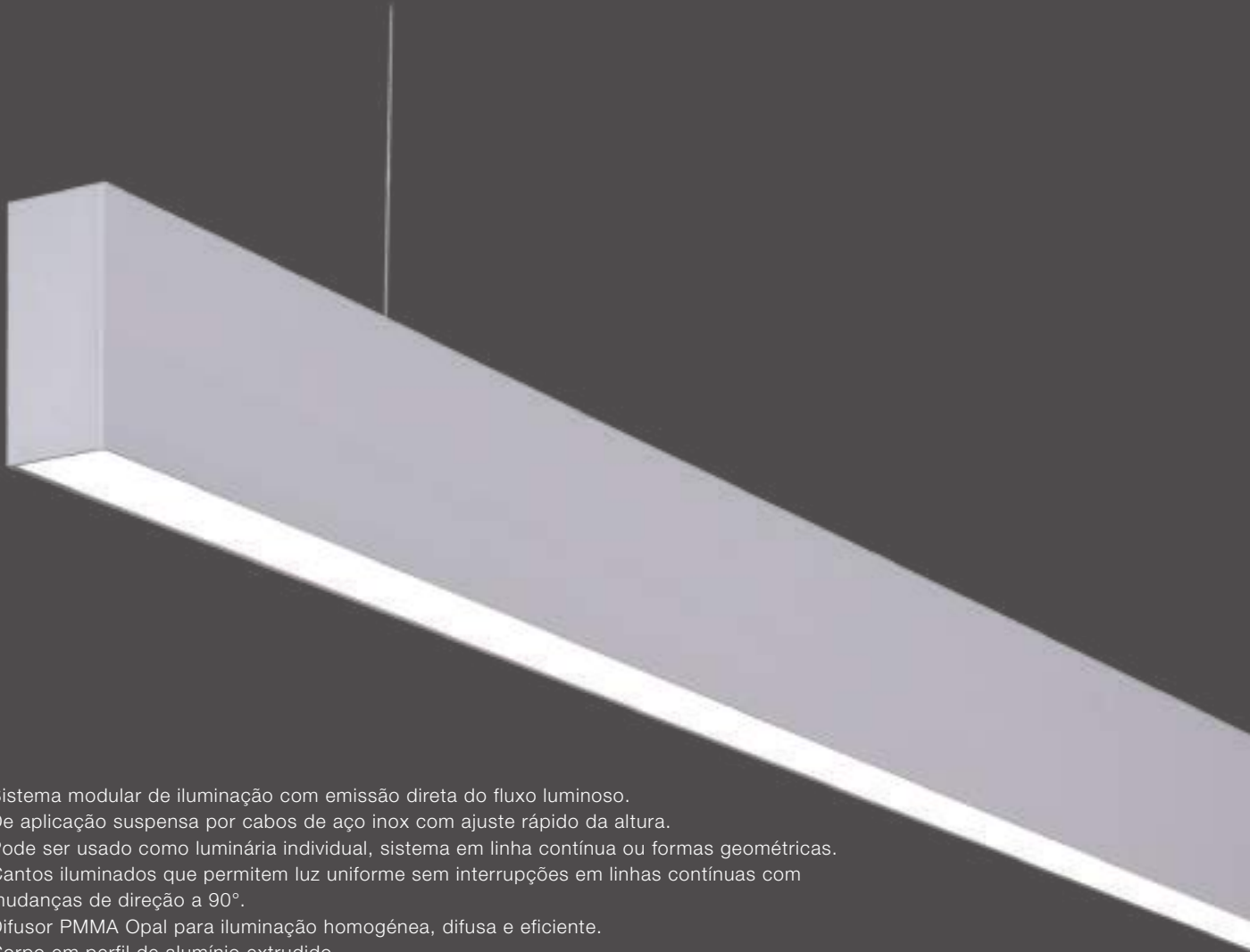

## PT

- > Sistema modular de iluminação com emissão direta do fluxo luminoso.
- > De aplicação suspensa por cabos de aço inox com ajuste rápido da altura.
- > Pode ser usado como luminária individual, sistema em linha contínua ou formas geométricas.
- > Cantos iluminados que permitem luz uniforme sem interrupções em linhas contínuas com mudanças de direção a 90°.
- > Difusor PMMA Opal para iluminação homogénea, difusa e eficiente.
- > Corpo em perfil de alumínio extrudido.
- > Topos injetados e sem parafusos.

## ES

- > Sistema modular de iluminación con emisión directa del flujo luminoso.
- > De aplicación suspendida por cables de acero inoxidable con regulación de la altura.
- > Se puede usar como luminaria individual, sistema en línea continua o formas geométricas.
- > Esquinas iluminadas aseguran luz uniforme sin interrupciones en las líneas continuas con cambios de dirección de 90°.
- > Difusor PMMA Opal.
- > Cuerpo en perfil de aluminio extruido.
- > Tapas finales inyectadas y sin tornillos.



**QUICK INFO**

**GENERAL**

Suspended  
 IP40  
 IK04  
 750°C  
 Class I  
 Ta= -20°C +35°C

**OPTIC**

Opal PMMA

**LED**

Efficacy up to 188 lm/W  
 3000 K, 4000 K  
 CRI >80  
 Lifetime 72 000 H  
 L80/B10 @Tc=65°C

**ELETRICAL SYSTEM**

230V/50Hz  
 ON/OFF, DALI

**FINISHING**

RAL 9003 Matt White  
 Matt Anodized

**SNAP SUSPENDED - DIRECT LIGHT  
 OPAL DIFFUSER**

**MATT WHITE FINISHING**

c (mm)	Output (lm)	System (W)	ON/OFF	DALI
<b>3000 K</b>				
852	1593	18	33.42.33.00.005	33.42.33.00.015
1134	2124	24	33.42.33.00.006	33.42.33.00.016
1415	2655	30	33.42.33.00.007	33.42.33.00.017
2258	4248	48	33.42.33.00.008	33.42.33.00.018
2539	4779	54	33.42.33.00.009	33.42.33.00.019
Corner 595x595	2124	24	33.42.33.00.501	33.42.33.00.503
<b>4000 K</b>				
852	1666	18	33.42.33.00.025	33.42.33.00.035
1134	2222	24	33.42.33.00.026	33.42.33.00.036
1415	2777	30	33.42.33.00.027	33.42.33.00.037
2258	4443	48	33.42.33.00.028	33.42.33.00.038
2539	4998	54	33.42.33.00.029	33.42.33.00.039
Corner 595x595	2222	24	33.42.33.00.505	33.42.33.00.507

**OPTIONS**

**LED**

2700 K, 5000 K, 6500 K  
 Tunable White, RGB, RGBW  
 CRI >90

**ELECTRICAL SYSTEM**

DSI, DIM 1-10V, Phase-cut

**CONTROL SYSTEM**

Bluetooth

**FINISHING**

 Other Colours

**EMERGENCY**

1 Hour, 3 Hours  
 DALI 1 Hour, 3 Hours

**SENSORS**

Motion  
 Ambient Light  
 Motion & Ambient Light

**MATT ANODIZED FINISHING**

c (mm)	Output (lm)	System (W)	ON/OFF	DALI
<b>3000 K</b>				
852	1593	18	33.42.33.00.000	33.42.33.00.010
1134	2124	24	33.42.33.00.001	33.42.33.00.011
1415	2655	30	33.42.33.00.002	33.42.33.00.012
2258	4248	48	33.42.33.00.003	33.42.33.00.013
2539	4779	54	33.42.33.00.004	33.42.33.00.014
Corner 595x595	2124	24	33.42.33.00.500	33.42.33.00.502
<b>4000 K</b>				
852	1666	18	33.42.33.00.020	33.42.33.00.030
1134	2222	24	33.42.33.00.021	33.42.33.00.031
1415	2777	30	33.42.33.00.022	33.42.33.00.032
2258	4443	48	33.42.33.00.023	33.42.33.00.033
2539	4998	54	33.42.33.00.024	33.42.33.00.034
Corner 595x595	2222	24	33.42.33.00.504	33.42.33.00.506

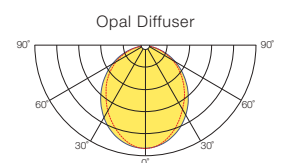
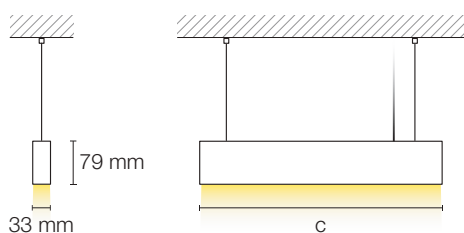

# SNAP DIRECT LIGHT SUSPENDED

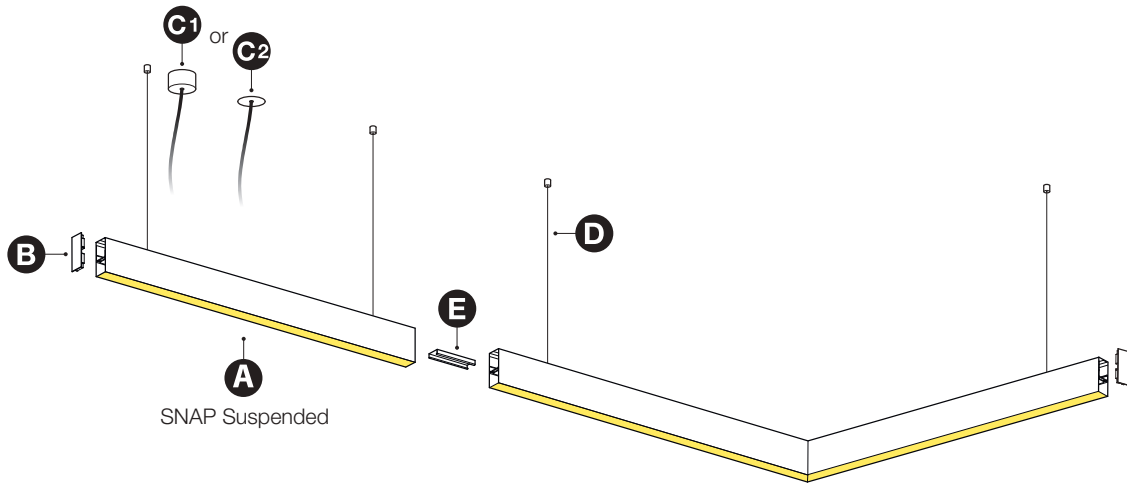

## COMPONENTS



### **B** END CAP (1pc)

	COD
Matt White	35.42.33.00.000
Matt Anodized Similar Painting	35.42.33.00.001



### **C1** SURFACE CEILING CUP (1pc)

MATT WHITE	DIMENSION	1m	3m	5m
ON/OFF	Ø62x36 mm	35.42.001.01.80	35.42.001.01.88	35.42.001.01.96
ON/OFF + EM	Ø62x36 mm	35.42.001.01.81	35.42.001.01.89	35.42.001.01.97
DALI	Ø62x36 mm	35.42.001.01.82	35.42.001.01.90	35.42.001.01.98
DALI + EM	Ø103x36 mm	35.42.001.01.83	35.42.001.01.91	35.42.001.01.99



### **C2** RECESSED CEILING CUP (1pc)

MATT WHITE	DIMENSION	1m	3m	5m
ON/OFF	Ø80 mm	35.42.001.01.84	35.42.001.01.92	35.42.002.01.00
ON/OFF + EM ON/OFF	Ø80 mm	35.42.001.01.85	35.42.001.01.93	35.42.002.01.01
DALI	Ø80 mm	35.42.001.01.86	35.42.001.01.94	35.42.002.01.02
DALI + EM DALI	Ø80 mm	35.42.001.01.87	35.42.001.01.95	35.42.002.01.03



### **D** SUSPENSION SYSTEM (2pcs)

TYPE	1m	3m	5m
Matt White + Stainless Steel Cable	35.42.000.01.54	35.42.000.01.62	35.42.001.01.26



**E LINEAR COUPLER (1pc)**

**COD**

Coupler

35.42.33.10.000

**OPTIONS**



**EMERGENCY (EM) - SELF-TEST INTEGRATED**

**ON/OFF**

**COD**

EM 1H 3W

35.00.003.01.23\*

**DALI**

**COD**

EM 1H 5,4W DALI

35.00.004.01.54\*

\* Applies to lengths equal to or greater than 1415 mm.

> On request – External Emergency. Box dimensions: 45x120x360 mm.



# SNAP DIRECT & INDIRECT LIGHT SUSPENDED



## PT

- > Sistema modular de iluminação com emissão direta (70%) e indireta (30%) do fluxo.
- > De aplicação suspensa por cabos de aço inox com ajuste rápido da altura.
- > Pode ser usado como luminária individual, sistema em linha contínua ou formas geométricas.
- > Cantos iluminados que permitem luz uniforme sem interrupções em linhas contínuas com mudanças de direção a 90°.
- > Difusor PMMA Opal para iluminação homogénea, difusa e eficiente.
- > Corpo em perfil de alumínio extrudido.
- > Topos injetados e sem parafusos.

## ES

- > Sistema modular de iluminación con emisión directa (70%) e indirecta (30%) del flujo.
- > De aplicación suspendida por cables de acero inoxidable con regulación de la altura.
- > Se puede usar como luminaria individual, sistema en línea continua o formas geométricas.
- > Esquinas iluminadas aseguran luz uniforme sin interrupciones en las líneas continuas con cambios de dirección de 90°.
- > Difusor PMMA Opal.
- > Cuerpo en perfil de aluminio extruido.
- > Tapas finales inyectadas y sin tornillos.

**QUICK INFO**

**GENERAL**

Suspended  
 IP40  
 IK04  
 750°C  
 Class I  
 Ta= -20°C +35°C

**OPTIC**

Opal PMMA

**LED**

Efficacy up to 188 lm/W  
 3000 K, 4000 K  
 CRI >80  
 Lifetime 72 000 H  
 L80/B10 @Tc=65°C

**ELETRICAL SYSTEM**

230V/50Hz  
 ON/OFF, DALI  
 Direct / Indirect - Simultaneous Control

**FINISHING**

RAL 9003 Matt White  
 Matt Anodized

**OPTIONS**

**LED**

2700 K, 5000 K, 6500 K  
 Tunable White, RGB, RGBW  
 CRI >90

**ELECTRICAL SYSTEM**

DSI, DIM 1-10V, Phase-cut  
 Direct / Indirect - Separate Control

**CONTROL SYSTEM**

Bluetooth

**FINISHING**

 Other Colours

**EMERGENCY**

1 Hour, 3 Hours  
 DALI 1 Hour, 3 Hours

**SENSORS**

Motion  
 Ambient Light  
 Motion & Ambient Light

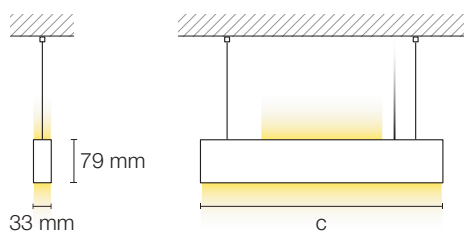

**SNAP SUSPENDED - DIRECT & INDIRECT LIGHT  
 OPAL DIFFUSER**

**MATT WHITE FINISHING**

c (mm)	Output (lm)	System (W)	ON/OFF	DALI
<b>3000 K</b>				
1415	3765	42	33.42.33.01.003	33.42.33.01.009
2258	6467	72	33.42.33.01.004	33.42.33.01.010
2539	7553	85	33.42.33.01.005	33.42.33.01.011
Corner 595x595 *	2124	24	33.42.33.01.501	33.42.33.01.503
<b>4000 K</b>				
1415	3938	42	33.42.33.01.015	33.42.33.01.021
2258	6765	72	33.42.33.01.016	33.42.33.01.022
2539	7900	85	33.42.33.01.017	33.42.33.01.023
Corner 595x595 *	2222	24	33.42.33.01.505	33.42.33.01.507

\* Direct Light only.

**MATT ANODIZED FINISHING**

c (mm)	Output (lm)	System (W)	ON/OFF	DALI
<b>3000 K</b>				
1415	3765	42	33.42.33.01.000	33.42.33.01.006
2258	6467	72	33.42.33.01.001	33.42.33.01.007
2539	7553	85	33.42.33.01.002	33.42.33.01.008
Corner 595x595 *	2124	24	33.42.33.01.500	33.42.33.01.502
<b>4000 K</b>				
1415	3938	42	33.42.33.01.012	33.42.33.01.018
2258	6765	72	33.42.33.01.013	33.42.33.01.019
2539	7900	85	33.42.33.01.014	33.42.33.01.020
Corner 595x595 *	2222	24	33.42.33.01.504	33.42.33.01.506

\* Direct Light only.



Opal Diffuser

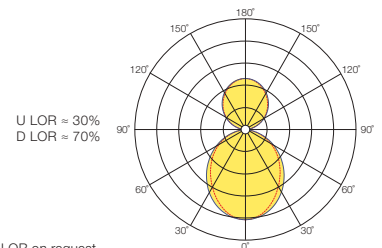

# SNAP DIRECT & INDIRECT LIGHT SUSPENDED

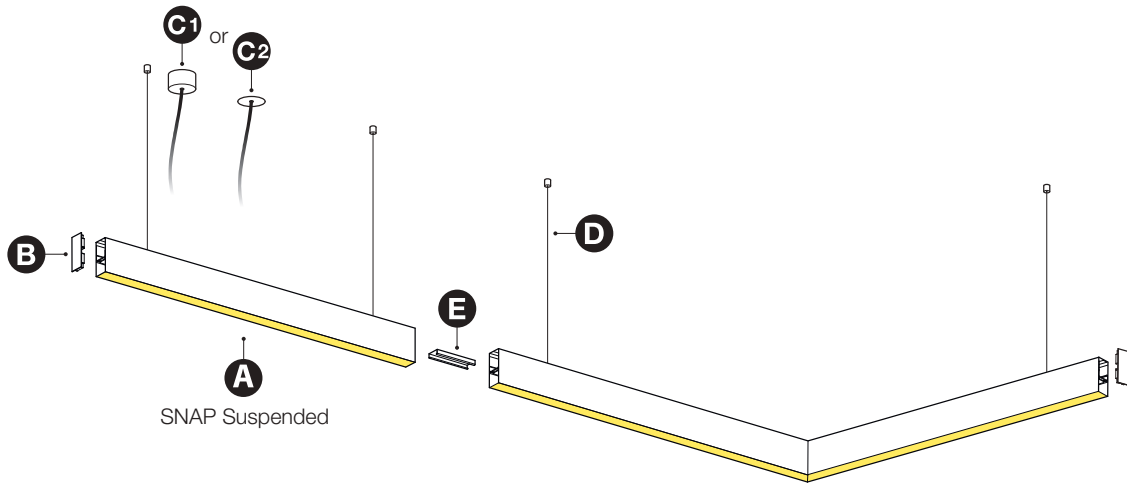

## COMPONENTS



### **B** END CAP (1pc)

	<b>COD</b>
Matt White	35.42.33.00.000
Matt Anodized Similar Painting	35.42.33.00.001



### **C1** SURFACE CEILING CUP (1pc)

<b>MATT WHITE</b>	<b>DIMENSION</b>	<b>1m</b>	<b>3m</b>	<b>5m</b>
ON/OFF	Ø62x36 mm	35.42.001.01.80	35.42.001.01.88	35.42.001.01.96
DALI	Ø62x36 mm	35.42.001.01.82	35.42.001.01.90	35.42.001.01.98



### **C2** RECESSED CEILING CUP (1pc)

<b>MATT WHITE</b>	<b>DIMENSION</b>	<b>1m</b>	<b>3m</b>	<b>5m</b>
ON/OFF	Ø80 mm	35.42.001.01.84	35.42.001.01.92	35.42.002.01.00
DALI	Ø80 mm	35.42.001.01.86	35.42.001.01.94	35.42.002.01.02



### **D** SUSPENSION SYSTEM (2pcs)

<b>TYPE</b>	<b>1m</b>	<b>3m</b>	<b>5m</b>
Matt White + Stainless Steel Cable	35.42.000.01.54	35.42.000.01.62	35.42.001.01.26



### **E** LINEAR COUPLER (1pc)

	<b>COD</b>
Coupler	35.42.33.10.000



# ALPHA TRACK SUSPENDED

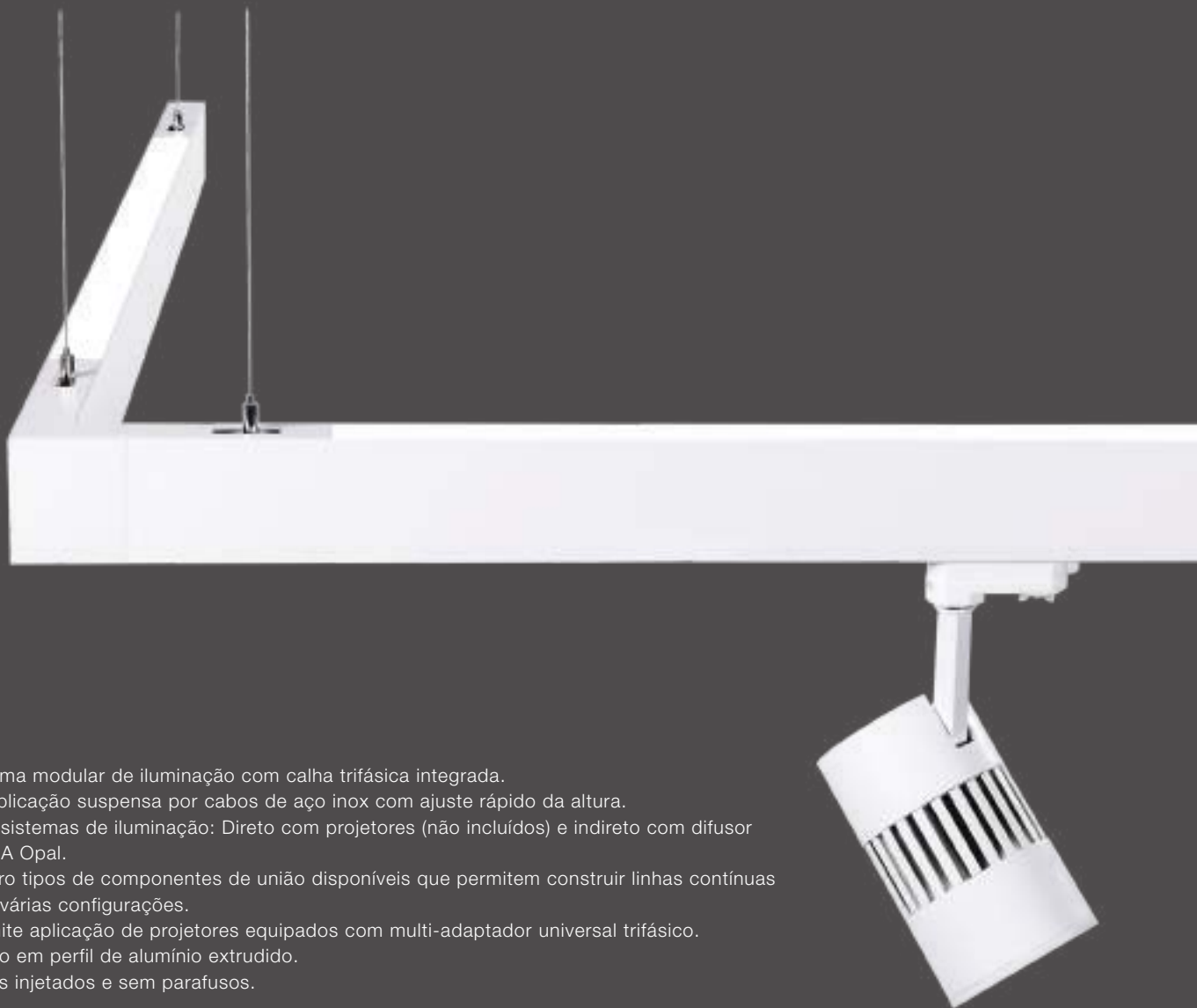

## PT

- > Sistema modular de iluminação com calha trifásica integrada.
- > De aplicação suspensa por cabos de aço inox com ajuste rápido da altura.
- > Dois sistemas de iluminação: Direto com projetores (não incluídos) e indireto com difusor PMMA Opal.
- > Quatro tipos de componentes de união disponíveis que permitem construir linhas contínuas com várias configurações.
- > Permite aplicação de projetores equipados com multi-adaptador universal trifásico.
- > Corpo em perfil de alumínio extrudido.
- > Topos injetados e sem parafusos.

## ES

- > Sistema modular de iluminación con raíl trifásico integrado.
- > De aplicación suspendida por cables de acero inoxidable con regulación de la altura.
- > Dos sistemas de alumbrado: Directo con proyectores (non incluidos) e indirecto con difusor PMMA Opal.
- > Cuatro tipos de componentes de unión disponibles que permiten construir líneas continuas en varias configuraciones.
- > Permite la aplicación de proyectores equipados con adaptador universal para carril trifásico.
- > Cuerpo en perfil de aluminio extruido.
- > Tapas finales inyectadas y sin tornillos.



**QUICK INFO**

**GENERAL**

Suspended  
 IP20  
 IK04  
 750°C  
 Class I  
 Ta= -20°C +35°C

**OPTIC**

Opal PMMA (Indirect Light)

**LED**

Efficacy up to 188 lm/W  
 3000 K, 4000 K  
 CRI >80  
 Lifetime 72 000 H  
 L80/B10 @Tc=65°C

**ELETRICAL SYSTEM**

230V/50Hz  
 ON/OFF - Track Ref. XTS  
 DALI - Track Ref. XTSC  
 Direct / Indirect - Separate Control

**FINISHING**

RAL 9003 Matt White  
 Metallic Grey

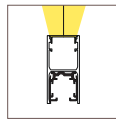

**ALPHA TRACK SUSPENDED - PROFILE WITH INDIRECT LIGHT**

**MATT WHITE FINISHING**

c (mm)	Output (lm)	System (W)	ON/OFF	DALI
<b>3000 K</b>				
1995	1062	12	33.42.33.02.011	33.42.33.02.017
2995	2655	30	33.42.33.02.013	33.42.33.02.019
<b>4000 K</b>				
1995	1111	12	33.42.33.02.023	33.42.33.02.029
2995	2777	30	33.42.33.02.025	33.42.33.02.031

**METALLIC GREY FINISHING**

c (mm)	Output (lm)	System (W)	ON/OFF	DALI
<b>3000 K</b>				
1995	1062	12	33.42.33.02.008	33.42.33.02.014
2995	2655	30	33.42.33.02.010	33.42.33.02.016
<b>4000 K</b>				
1995	1111	12	33.42.33.02.020	33.42.33.02.026
2995	2777	30	33.42.33.02.022	33.42.33.02.028

**OPTIONS**

**LED**

2700 K, 5000 K, 6500 K  
 Tunable White, RGB, RGBW  
 CRI >90

**ELECTRICAL SYSTEM**

DSI, DIM 1-10V, Phase-cut

**CONTROL SYSTEM**

Bluetooth

**FINISHING**

Other Colours

**EMERGENCY**

1 Hour, 3 Hours  
 DALI 1 Hour, 3 Hours

**SENSORS**

Motion  
 Ambient Light  
 Motion & Ambient Light

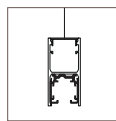

**ALPHA TRACK SUSPENDED - PROFILE**

**MATT WHITE FINISHING**

c (mm)	ON/OFF	DALI
1995	33.42.33.02.002	33.42.33.02.006
2995	33.42.33.02.003	33.42.33.02.007

**METALLIC GREY FINISHING**

c (mm)	ON/OFF	DALI
1995	33.42.33.02.000	33.42.33.02.004
2995	33.42.33.02.001	33.42.33.02.005

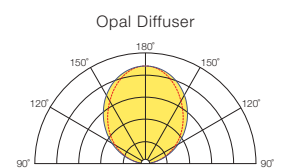
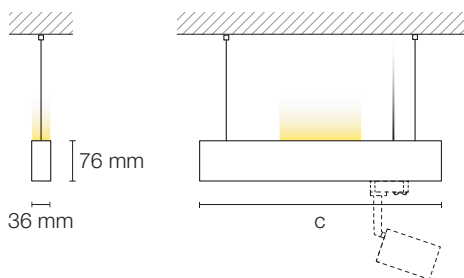

# ALPHA TRACK SUSPENDED

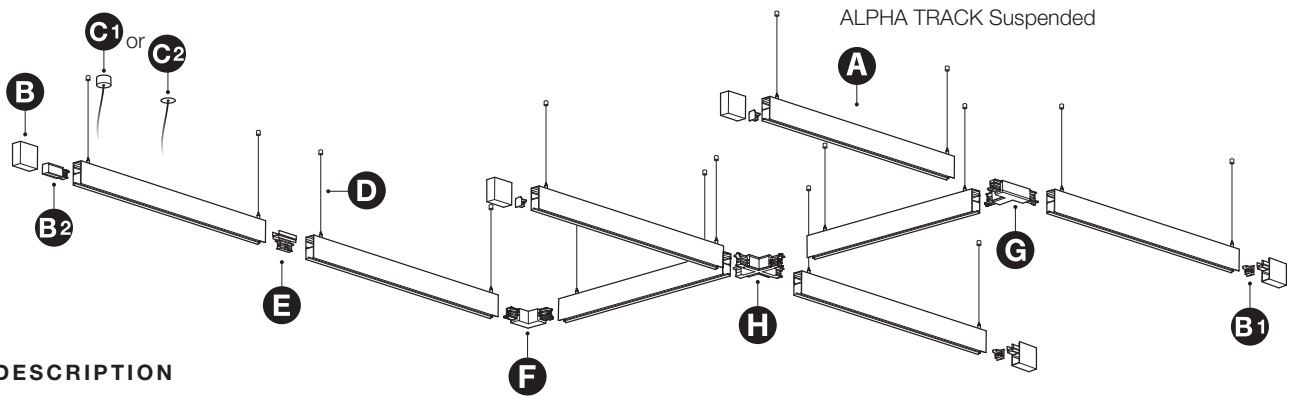

## DESCRIPTION

— > Red Line indicates polarity.

⚡ > Feed Unit.

## COMPONENTS



<b>B</b> END CAP (1pc)		MATT WHITE		METALLIC GREY
End Cap		35.42.33.02.001		35.42.33.02.000



<b>B1</b> END CAP TRACK ADAPTER (1pc)	REF	MATT WHITE	REF	METALLIC GREY
End Cap Track Adapter	XTS 41-3	35.42.007.08.56	XTS 41-1	35.42.004.08.11



<b>B2</b> END FEED TRACK ADAPTER (1pc)		REF	MATT WHITE	REF	METALLIC GREY
⚡ End Feed Track Adapter - Type 1	ON/OFF	XTS 11-3	35.42.007.08.52	XTS 11-1	35.42.004.08.07
	DALI	XTSC 611-3	35.42.007.08.54	XTSC 611-1	35.42.004.08.09
⚡ End Feed Track Adapter - Type 2	ON/OFF	XTS 12-3	35.42.007.08.53	XTS 12-1	35.42.004.08.08
	DALI	XTSC 612-3	35.42.007.08.55	XTSC 612-1	35.42.004.08.10



<b>F</b> "L" FEED (1pc)		REF	MATT WHITE	REF	METALLIC GREY
⚡ "L" Feed Track Adapter - Type 1	ON/OFF	XTS 34-3	35.42.33.02.006	XTS 34-1	35.42.33.02.002
	DALI	XTSC 634-3	35.42.33.02.008	XTSC 634-1	35.42.33.02.004
⚡ "L" Feed Track Adapter - Type 2	ON/OFF	XTS 35-3	35.42.33.02.007	XTS 35-1	35.42.33.02.003
	DALI	XTSC 635-3	35.42.33.02.009	XTSC 635-1	35.42.33.02.005

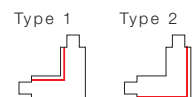
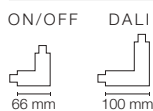



<b>G "T" FEED (1pc)</b>		REF	MATT WHITE	REF	METALLIC GREY
	"T" Feed Track Adapter - Type 1	ON/OFF	XTS 36-3 35.42.33.02.022	XTS 36-1	35.42.33.02.014
		DALI	XTSC 636-3 35.42.33.02.026	XTSC 636-1	35.42.33.02.018
	"T" Feed Track Adapter - Type 2	ON/OFF	XTS 37-3 35.42.33.02.023	XTS 37-1	35.42.33.02.015
		DALI	XTSC 637-3 35.42.33.02.027	XTSC 637-1	35.42.33.02.019
	"T" Feed Track Adapter - Type 3	ON/OFF	XTS 39-3 35.42.33.02.024	XTS 39-1	35.42.33.02.016
		DALI	XTSC 639-3 35.42.33.02.028	XTSC 639-1	35.42.33.02.020
	"T" Feed Track Adapter - Type 4	ON/OFF	XTS 40-3 35.42.33.02.025	XTS 40-1	35.42.33.02.017
		DALI	XTSC 640-3 35.42.33.02.029	XTSC 640-1	35.42.33.02.021



<b>H "X" FEED (1pc)</b>		REF	MATT WHITE	REF	METALLIC GREY
	"X" Feed Track Adapter	ON/OFF	XTS 38-3 35.42.33.02.012	XTS 38-1	35.42.33.02.010
		DALI	XTS 638-3 35.42.33.02.013	XTS 638-1	35.42.33.02.011

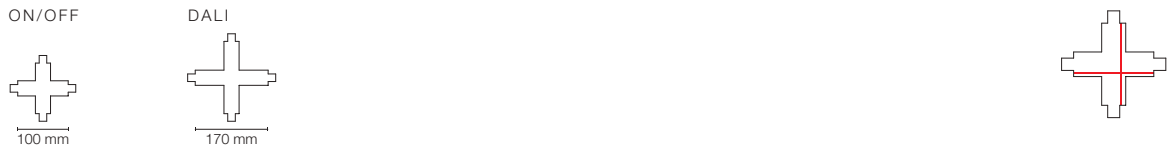

<b>E STRAIGHT CONNECTOR (1pc)</b>		REF	MATT WHITE	REF	METALLIC GREY
Straight Connector Track Adapter	ON/OFF	XTS 21-3 35.42.007.08.57	XTS 21-1	35.42.004.08.12	
	DALI	XTSC 621-3 35.42.007.08.58	XTS 621-1	35.42.004.08.13	



<b>C1 SURFACE CEILING CUP (1pc)</b>		DIMENSION	1m	3m	5m
<b>MATT WHITE</b>	<b>1</b> - ON/OFF (Profile)	Ø103x36 mm	35.42.002.01.04	35.42.002.01.12	35.42.002.01.20
	<b>1</b> - ON/OFF (Profile with Indirect Light)	Ø103x36 mm	35.42.002.01.05	35.42.002.01.13	35.42.002.01.21
<b>DALI</b>	<b>1</b> - DALI (Profile)	Ø103x36 mm	35.42.002.01.06	35.42.002.01.14	35.42.002.01.22
	<b>2</b> - DALI (Profile with Indirect Light)	Ø103x36 mm	35.42.002.01.07	35.42.002.01.15	35.42.002.01.23



<b>C2 RECESSED CEILING CUP (1pc)</b>		DIMENSION	1m	3m	5m
<b>MATT WHITE</b>	<b>1</b> - ON/OFF (Profile)	Ø80 mm	35.42.002.01.08	35.42.002.01.16	35.42.002.01.24
	<b>1</b> - ON/OFF (Profile with Indirect Light)	Ø80 mm	35.42.002.01.09	35.42.002.01.17	35.42.002.01.25
<b>DALI</b>	<b>1</b> - DALI (Profile)	Ø80 mm	35.42.002.01.10	35.42.002.01.18	35.42.002.01.26
	<b>2</b> - DALI (Profile with Indirect Light)	Ø80 mm	35.42.002.01.11	35.42.002.01.19	35.42.002.01.27



<b>D SUSPENSION SYSTEM (2pcs)</b>		1m	3m	5m
<b>TYPE</b>	Matt White + Stainless Steel Cable	35.42.000.01.54	35.42.000.01.62	35.42.001.01.26

# SNAP SURFACE



## PT

- > Sistema modular de iluminação para aplicação saliente.
- > Pode ser usado como luminária individual, sistema em linha contínua ou formas geométricas.
- > Cantos iluminados que permitem luz uniforme sem interrupções em linhas contínuas com mudanças de direção a 90°.
- > Difusor PMMA Opal para iluminação homogénea, difusa e eficiente.
- > Corpo em perfil de alumínio extrudido.
- > Topos injetados e sem parafusos.

## ES

- > Sistema modular de iluminación para instalación en superficie.
- > Se puede usar como luminaria individual, sistema en línea continua o formas geométricas.
- > Esquinas iluminadas aseguran luz uniforme sin interrupciones en las líneas continuas con cambios de dirección de 90°.
- > Difusor PMMA Opal.
- > Cuerpo en perfil de aluminio extruido.
- > Tapas finales inyectadas y sin tornillos.

**QUICK INFO**

**GENERAL**

Surface  
IP40  
IK04  
750°C  
Class I  
Ta= -20°C +35°C

**OPTIC**

Opal PMMA

**LED**

Efficacy up to 188 lm/W  
3000 K, 4000 K  
CRI >80  
Lifetime 72 000 H  
L80/B10 @Tc=65°C

**ELETRICAL SYSTEM**

230V/50Hz  
ON/OFF, DALI

**FINISHING**

RAL 9003 Matt White  
Matt Anodized

**SNAP SURFACE**

**OPAL DIFFUSER**

**MATT WHITE FINISHING**

c (mm)	Output (lm)	System (W)	ON/OFF	DALI
<b>3000 K</b>				
852	1593	18	33.42.33.10.005	33.42.33.10.015
1134	2124	24	33.42.33.10.006	33.42.33.10.016
1415	2655	30	33.42.33.10.007	33.42.33.10.017
2258	4248	48	33.42.33.10.008	33.42.33.10.018
2539	4779	54	33.42.33.10.009	33.42.33.10.019
Corner 595x595	2124	24	33.42.33.10.501	33.42.33.10.503
<b>4000 K</b>				
852	1666	18	33.42.33.10.025	33.42.33.10.035
1134	2222	24	33.42.33.10.026	33.42.33.10.036
1415	2777	30	33.42.33.10.027	33.42.33.10.037
2258	4443	48	33.42.33.10.028	33.42.33.10.038
2539	4998	54	33.42.33.10.029	33.42.33.10.039
Corner 595x595	2222	24	33.42.33.10.505	33.42.33.10.507

**OPTIONS**

**LED**

2700 K, 5000 K, 6500 K  
Tunable White, RGB, RGBW  
CRI >90

**ELECTRICAL SYSTEM**

DSI, DIM 1-10V, Phase-cut

**CONTROL SYSTEM**

Bluetooth

**FINISHING**

 Other Colours

**EMERGENCY**

1 Hour, 3 Hours  
DALI 1 Hour, 3 Hours

**SENSORS**

Motion  
Ambient Light  
Motion & Ambient Light

**MATT ANODIZED FINISHING**

c (mm)	Output (lm)	System (W)	ON/OFF	DALI
<b>3000 K</b>				
852	1593	18	33.42.33.10.000	33.42.33.10.010
1134	2124	24	33.42.33.10.001	33.42.33.10.011
1415	2655	30	33.42.33.10.002	33.42.33.10.012
2258	4248	48	33.42.33.10.003	33.42.33.10.013
2539	4779	54	33.42.33.10.004	33.42.33.10.014
Corner 595x595	2124	24	33.42.33.10.500	33.42.33.10.502
<b>4000 K</b>				
852	1666	18	33.42.33.10.020	33.42.33.10.030
1134	2222	24	33.42.33.10.021	33.42.33.10.031
1415	2777	30	33.42.33.10.022	33.42.33.10.032
2258	4443	48	33.42.33.10.023	33.42.33.10.033
2539	4998	54	33.42.33.10.024	33.42.33.10.034
Corner 595x595	2222	24	33.42.33.10.504	33.42.33.10.506

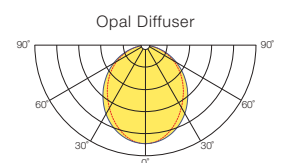
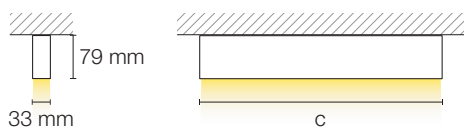

# SNAP SURFACE

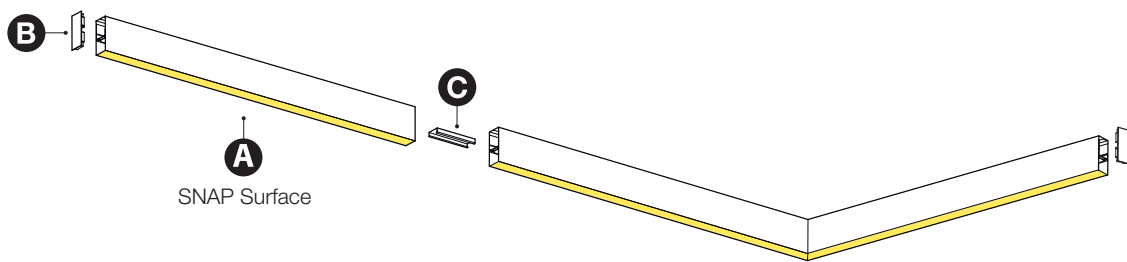

## COMPONENTS



### **B** END CAP (1pc)

	<b>COD</b>
Matt White	35.42.33.00.000
Matt Anodized Similar Painting	35.42.33.00.001



### **C** LINEAR COUPLER (1pc)

	<b>COD</b>
Coupler	35.42.33.10.000

## OPTIONS



### **EMERGENCY (EM) - SELF-TEST INTEGRATED**

<b>ON/OFF</b>	<b>COD</b>
EM 1H 3W	35.00.003.01.23*

<b>DALI</b>	<b>COD</b>
EM 1H 5,4W DALI	35.00.004.01.54*

\* Applies to lengths equal to or greater than 1415 mm.

> On request – External Emergency. Box dimensions: 45x120x360 mm.



# SNAP MINI SURFACE

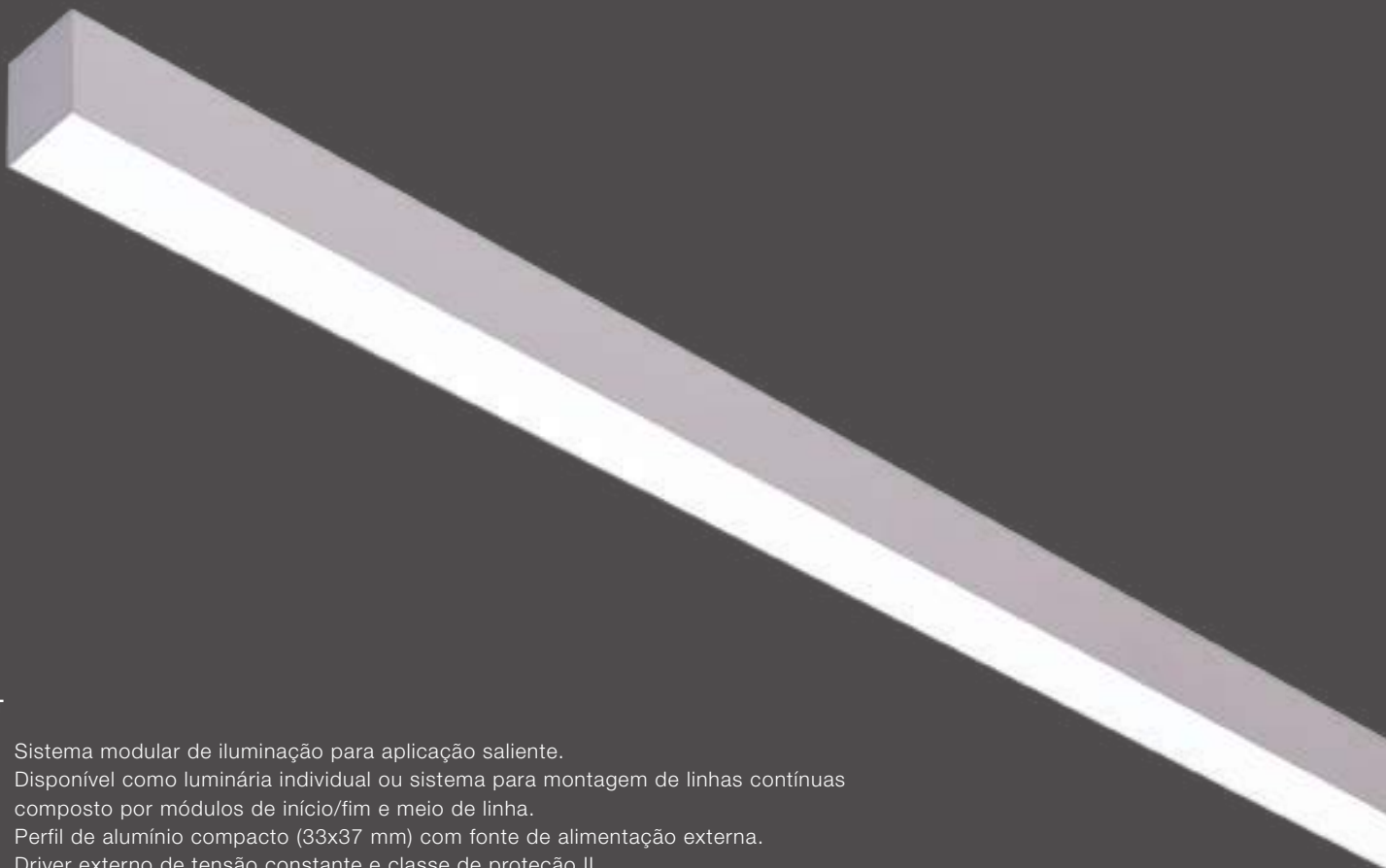

## PT

- > Sistema modular de iluminação para aplicação saliente.
- > Disponível como luminária individual ou sistema para montagem de linhas contínuas composto por módulos de início/fim e meio de linha.
- > Perfil de alumínio compacto (33x37 mm) com fonte de alimentação externa.
- > Driver externo de tensão constante e classe de proteção II.
- > Difusor PMMA Opal para iluminação homogénea, difusa e eficiente.
- > Corpo em perfil de alumínio extrudido.
- > Inclui topos e guias de união.

## ES

- > Sistema modular de iluminación para para instalación en superficie.
- > Disponible en versión luminaria individual o sistemas para el montaje de líneas continuas con módulos de inicio/fin y medio de línea.
- > Perfil de aluminio compacto (33x37 mm) con fuente de alimentación externa.
- > Driver externo de tensión constante y clase de protección II.
- > Difusor PMMA Opal.
- > Cuerpo en perfil de aluminio extruido.
- > Incluye tapas finales y guías de unión.



**QUICK INFO**

**GENERAL**

Surface  
 IP40  
 IK04  
 750°C  
 Class III  
 Ta= -20°C +35°C

**OPTIC**

Opal PMMA

**LED**

Efficacy up to 137 lm/W  
 3000 K, 4000 K  
 CRI >80  
 Lifetime 50 000 H  
 L80/B10 @Tc=55°C  
 24 VDC

**ELETRICAL SYSTEM**

230V/50Hz  
 ON/OFF, DALI

**FINISHING**

RAL 9003 Matt White  
 Matt Anodized

**SNAP MINI SURFACE - INDIVIDUAL  
 OPAL DIFFUSER**

c (mm)	Output (lm)	LED Power (W)	LED Voltage	MATT WHITE	ANODIZED
<b>3000 K</b>					
432	244	5,5	24 VDC	33.42.33.11.006	33.42.33.11.000
832	489	11	24 VDC	33.42.33.11.007	33.42.33.11.001
1238	733	16,5	24 VDC	33.42.33.11.008	33.42.33.11.002
1640	977	22	24 VDC	33.42.33.11.009	33.42.33.11.003
2042	1221	27,5	24 VDC	33.42.33.11.010	33.42.33.11.004
2444	1466	33	24 VDC	33.42.33.11.011	33.42.33.11.005
<b>4000 K</b>					
432	244	5,5	24 VDC	33.42.33.11.018	33.42.33.11.012
832	489	11	24 VDC	33.42.33.11.019	33.42.33.11.013
1238	733	16,5	24 VDC	33.42.33.11.020	33.42.33.11.014
1640	977	22	24 VDC	33.42.33.11.021	33.42.33.11.015
2042	1221	27,5	24 VDC	33.42.33.11.022	33.42.33.11.016
2444	1466	33	24 VDC	33.42.33.11.023	33.42.33.11.017

**COMPONENTS**

**DRIVER - EXTERNAL**

ON/OFF	DIMENSION	COD
Power Supply 4-32W IP20	21x40x220 mm	35.00.003.01.75
Power Supply 6-49W IP20	21x40x250 mm	35.00.003.01.74
Power Supply 12-86W IP20	21x40x300 mm	35.00.003.01.73
DALI	DIMENSION	COD
Power Supply 12-90W IP20	30x43x295 mm	35.00.003.01.76
Power Supply 18-135W IP20	31x43x325 mm	35.00.003.01.77

> External Driver to be housed nearby.



CLASS II

**OPTIONS**

**LED**

2700 K, 5000 K, 6500 K  
 Tunable White, RGB, RGBW  
 CRI >90

**ELETRICAL SYSTEM**

DSI, DIM 1-10V, Phase-cut

**CONTROL SYSTEM**

Bluetooth

**FINISHING**

Other Colours

**SENSORS**

Motion  
 Ambient Light  
 Motion & Ambient Light

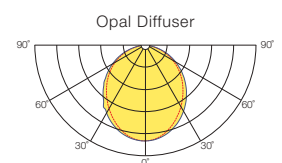
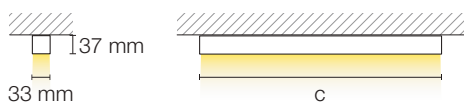

**QUICK INFO**

**GENERAL**

Surface  
 IP40  
 IK04  
 750°C  
 Class III  
 Ta= -20°C +35°C

**OPTIC**

Opal PMMA

**LED**

Efficacy up to 137 lm/W  
 3000 K, 4000 K  
 CRI >80  
 Lifetime 50 000 H  
 L80/B10 @Tc=55°C  
 24 VDC

**ELECTRICAL SYSTEM**

230V/50Hz  
 ON/OFF, DALI

**FINISHING**

RAL 9003 Matt White  
 Matt Anodized

**SNAP MINI SURFACE - CONTINUOUS LINE**

**OPAL DIFFUSER**

**BEGINNING/END OF LINE**

c (mm)	Output (lm)	LED Power (W)	LED Voltage	MATT WHITE	ANODIZED
<b>3000 K</b>					
416	244	5,5	24 VDC	33.42.33.11.030	33.42.33.11.024
816	489	11	24 VDC	33.42.33.11.031	33.42.33.11.025
1222	733	16,5	24 VDC	33.42.33.11.032	33.42.33.11.026
1624	977	22	24 VDC	33.42.33.11.033	33.42.33.11.027
2026	1221	27,5	24 VDC	33.42.33.11.034	33.42.33.11.028
2428	1466	33	24 VDC	33.42.33.11.035	33.42.33.11.029
<b>4000 K</b>					
416	244	5,5	24 VDC	33.42.33.11.042	33.42.33.11.036
816	489	11	24 VDC	33.42.33.11.043	33.42.33.11.037
1222	733	16,5	24 VDC	33.42.33.11.044	33.42.33.11.038
1624	977	22	24 VDC	33.42.33.11.045	33.42.33.11.039
2026	1221	27,5	24 VDC	33.42.33.11.046	33.42.33.11.040
2428	1466	33	24 VDC	33.42.33.11.047	33.42.33.11.041

**MIDDLE OF LINE**

c (mm)	Output (lm)	LED Power (W)	LED Voltage	MATT WHITE	ANODIZED
<b>3000 K</b>					
403	244	5,5	24 VDC	33.42.33.11.506	33.42.33.11.500
803	489	11	24 VDC	33.42.33.11.507	33.42.33.11.501
1209	733	16,5	24 VDC	33.42.33.11.508	33.42.33.11.502
1611	977	22	24 VDC	33.42.33.11.509	33.42.33.11.503
2013	1221	27,5	24 VDC	33.42.33.11.510	33.42.33.11.504
2415	1466	33	24 VDC	33.42.33.11.511	33.42.33.11.505
Corner 210x210	244	5,5	24 VDC	33.42.33.11.526	33.42.33.11.524
<b>4000 K</b>					
403	244	5,5	24 VDC	33.42.33.11.518	33.42.33.11.512
803	489	11	24 VDC	33.42.33.11.519	33.42.33.11.513
1209	733	16,5	24 VDC	33.42.33.11.520	33.42.33.11.514
1611	977	22	24 VDC	33.42.33.11.521	33.42.33.11.515
2013	1221	27,5	24 VDC	33.42.33.11.522	33.42.33.11.516
2415	1466	33	24 VDC	33.42.33.11.523	33.42.33.11.517
Corner 210x210	244	5,5	24 VDC	33.42.33.11.527	33.42.33.11.525

**BEGINNING/END OF LINE**

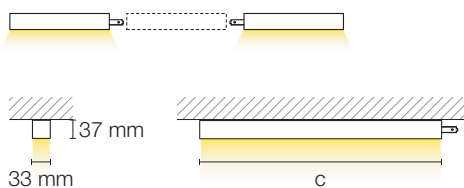

**MIDDLE OF LINE**

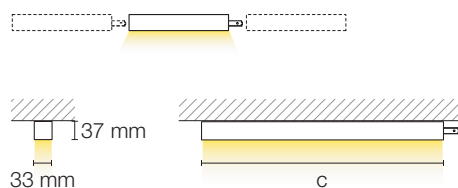

# SNAP MINI SURFACE

## COMPONENTS



CLASS II

### DRIVER - EXTERNAL

ON/OFF	DIMENSION	COD
Power Supply 4-32W IP20	21x40x220 mm	35.00.003.01.75
Power Supply 6-49W IP20	21x40x250 mm	35.00.003.01.74
Power Supply 12-86W IP20	21x40x300 mm	35.00.003.01.73
DALI	DIMENSION	COD
Power Supply 12-90W IP20	30x43x295 mm	35.00.003.01.76
Power Supply 18-135W IP20	31x43x325 mm	35.00.003.01.77

> External Driver to be housed nearby.



# GAP RECESSED



## PT

- > Sistema modular de iluminação para aplicação encastrada.
- > Pode ser usado como luminária individual, sistema em linha contínua ou formas geométricas.
- > Cantos iluminados que permitem luz uniforme sem interrupções em linhas contínuas com mudanças de direção a 90°.
- > Difusor PMMA Opal para iluminação homogénea, difusa e eficiente.
- > Corpo em perfil de alumínio extrudido.

## ES

- > Sistema modular de iluminación para instalación empotrada en el techo.
- > Se puede usar como luminaria individual, sistema en línea continua o formas geométricas.
- > Esquinas iluminadas aseguran luz uniforme sin interrupciones en las líneas continuas con cambios de dirección de 90°.
- > Difusor PMMA Opal.
- > Cuerpo en perfil de aluminio extruido.

**QUICK INFO**

**GENERAL**

Recessed  
 IP43 (Optic)  
 IP20  
 IK04  
 750°C  
 Class I  
 Ta= -20°C +35°C

**OPTIC**

Opal PMMA

**LED**

Efficacy up to 188 lm/W  
 3000 K, 4000 K  
 CRI >80  
 Lifetime 72 000 H  
 L80/B10 @Tc=65°C

**ELETRICAL SYSTEM**

230V/50Hz  
 ON/OFF, DALI

**FINISHING**

RAL 9003 Matt White  
 Matt Anodized

**OPTIONS**

**GENERAL** (Individual Luminaire)

IP44 (Optic)  
 Class II

**LED**

2700 K, 5000 K, 6500 K  
 Tunable White, RGB, RGBW  
 CRI >90

**ELECTRICAL SYSTEM**

DSI, DIM 1-10V, Phase-cut

**CONTROL SYSTEM**

Bluetooth

**FINISHING**

 Other Colours

**EMERGENCY**

1 Hour, 3 Hours  
 DALI 1 Hour, 3 Hours

**SENSORS**

Motion  
 Ambient Light  
 Motion & Ambient Light

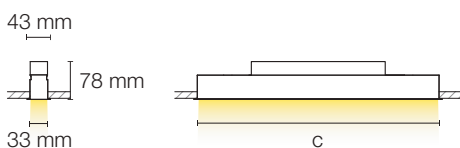

**GAP RECESSED**

**OPAL DIFFUSER**

**MATT WHITE FINISHING**

c (mm)	Output (lm)	System (W)	ON/OFF	DALI
<b>3000 K</b>				
857	1593	18	33.42.33.20.005	33.42.33.20.015
1138	2124	24	33.42.33.20.006	33.42.33.20.016
1419	2655	30	33.42.33.20.007	33.42.33.20.017
2262	4248	48	33.42.33.20.008	33.42.33.20.018
2543	4779	54	33.42.33.20.009	33.42.33.20.019
Corner 600x600	2124	24	33.42.33.20.501	33.42.33.20.503
<b>4000 K</b>				
857	1666	18	33.42.33.20.025	33.42.33.20.035
1138	2222	24	33.42.33.20.026	33.42.33.20.036
1419	2777	30	33.42.33.20.027	33.42.33.20.037
2262	4443	48	33.42.33.20.028	33.42.33.20.038
2543	4998	54	33.42.33.20.029	33.42.33.20.039
Corner 600x600	2222	24	33.42.33.20.505	33.42.33.20.507

**MATT ANODIZED FINISHING**

c (mm)	Output (lm)	System (W)	ON/OFF	DALI
<b>3000 K</b>				
857	1593	18	33.42.33.20.000	33.42.33.20.010
1138	2124	24	33.42.33.20.001	33.42.33.20.011
1419	2655	30	33.42.33.20.002	33.42.33.20.012
2262	4248	48	33.42.33.20.003	33.42.33.20.013
2543	4779	54	33.42.33.20.004	33.42.33.20.014
Corner 600x600	2124	24	33.42.33.20.500	33.42.33.20.502
<b>4000 K</b>				
857	1666	18	33.42.33.20.020	33.42.33.20.030
1138	2222	24	33.42.33.20.021	33.42.33.20.031
1419	2777	30	33.42.33.20.022	33.42.33.20.032
2262	4443	48	33.42.33.20.023	33.42.33.20.033
2543	4998	54	33.42.33.20.024	33.42.33.20.034
Corner 600x600	2222	24	33.42.33.20.504	33.42.33.20.506

**ON REQUEST (INDIVIDUAL LUMINAIRE)**

- > IP44 (OPTIC);
- > CLASS II;
- > EXTERNAL DRIVER:  45 mm

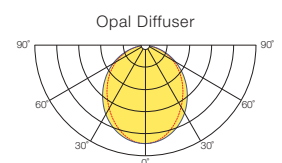

# GAP RECESSED

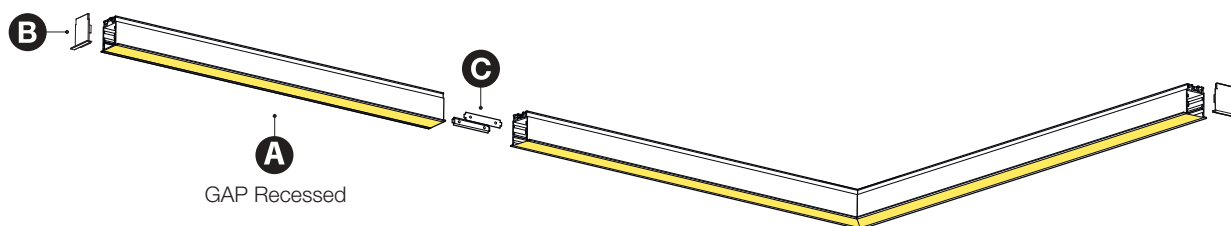

## COMPONENTS



### **B** END CAP (1pc)

Matt White

**COD**

35.42.33.20.000

Matt Anodized Similar Painting

35.42.33.20.001



### **C** LINEAR COUPLER (2pcs)

Coupler

**COD**

35.42.33.20.002



# GAP

## TRIMLESS



### PT

- > Sistema modular de iluminação para aplicação encastrada sem aba de remate (trimless).
- > Pode ser usado como luminária individual, sistema em linha contínua ou formas geométricas.
- > Cantos iluminados que permitem luz uniforme sem interrupções em linhas contínuas com mudanças de direção a 90°.
- > Difusor PMMA Opal para iluminação homogénea, difusa e eficiente.
- > Corpo em perfil de alumínio extrudido.

### ES

- > Sistema modular de iluminación para instalación empotrada sin marco de remate (trimless).
- > Se puede usar como luminaria individual, sistema en línea continua o formas geométricas.
- > Esquinas iluminadas aseguran luz uniforme sin interrupciones en las líneas continuas con cambios de dirección de 90°.
- > Difusor PMMA Opal.
- > Cuerpo en perfil de aluminio extruido.



**QUICK INFO**

**GENERAL**

Trimless  
 IP43 (Optic)  
 IP20  
 IK04  
 750°C  
 Class I  
 Ta= -20°C +35°C

**OPTIC**

Opal PMMA

**LED**

Efficacy up to 188 lm/W  
 3000 K, 4000 K  
 CRI >80  
 Lifetime 72 000 H  
 L80/B10 @TC=65°C

**ELETRICAL SYSTEM**

230V/50Hz  
 ON/OFF, DALI

**FINISHING**

RAL 9003 Matt White

**GAP TRIMLESS**

**OPAL DIFFUSER**

**MATT WHITE FINISHING**

c (mm)	Output (lm)	System (W)	ON/OFF	DALI
<b>3000 K</b>				
847	1593	18	33.42.33.30.000	33.42.33.30.005
1128	2124	24	33.42.33.30.001	33.42.33.30.006
1409	2655	30	33.42.33.30.002	33.42.33.30.007
2252	4248	48	33.42.33.30.003	33.42.33.30.008
2533	4779	54	33.42.33.30.004	33.42.33.30.009
Corner 610x610	2124	24	33.42.33.30.500	33.42.33.30.501
<b>4000 K</b>				
847	1666	18	33.42.33.30.010	33.42.33.30.015
1128	2222	24	33.42.33.30.011	33.42.33.30.016
1409	2777	30	33.42.33.30.012	33.42.33.30.017
2252	4443	48	33.42.33.30.013	33.42.33.30.018
2533	4998	54	33.42.33.30.014	33.42.33.30.019
Corner 610x610	2222	24	33.42.33.30.502	33.42.33.30.503

**OPTIONS**

**GENERAL** (Individual Luminaire)

IP44 (Optic)  
 Class II

**LED**

2700 K, 5000 K, 6500 K  
 Tunable White, RGB, RGBW  
 CRI >90

**ELECTRICAL SYSTEM**

DSI, DIM 1-10V, Phase-cut

**CONTROL SYSTEM**

Bluetooth

**EMERGENCY**

1 Hour, 3 Hours  
 DALI 1 Hour, 3 Hours

**SENSORS**

Motion  
 Ambient Light  
 Motion & Ambient Light

**COMPONENTS**

**END CAP (1pc)**



TYPE	COD
Matt White	35.42.33.30.001

**LINEAR COUPLER (1pc)**



TYPE	COD
Coupler	35.42.33.30.000

**ON REQUEST (INDIVIDUAL LUMINAIRE)**

- > IP44 (OPTIC);
- > CLASS II.

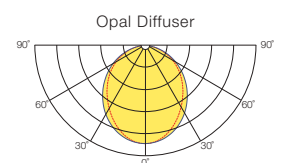
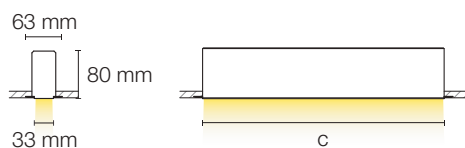



> **GAP TRIMLESS**



> **GAP** TRIMLESS

**SNAP** DIRECT OR INDIRECT LIGHT  
WALL





# SNAP

DIRECT OR INDIRECT LIGHT

## WALL

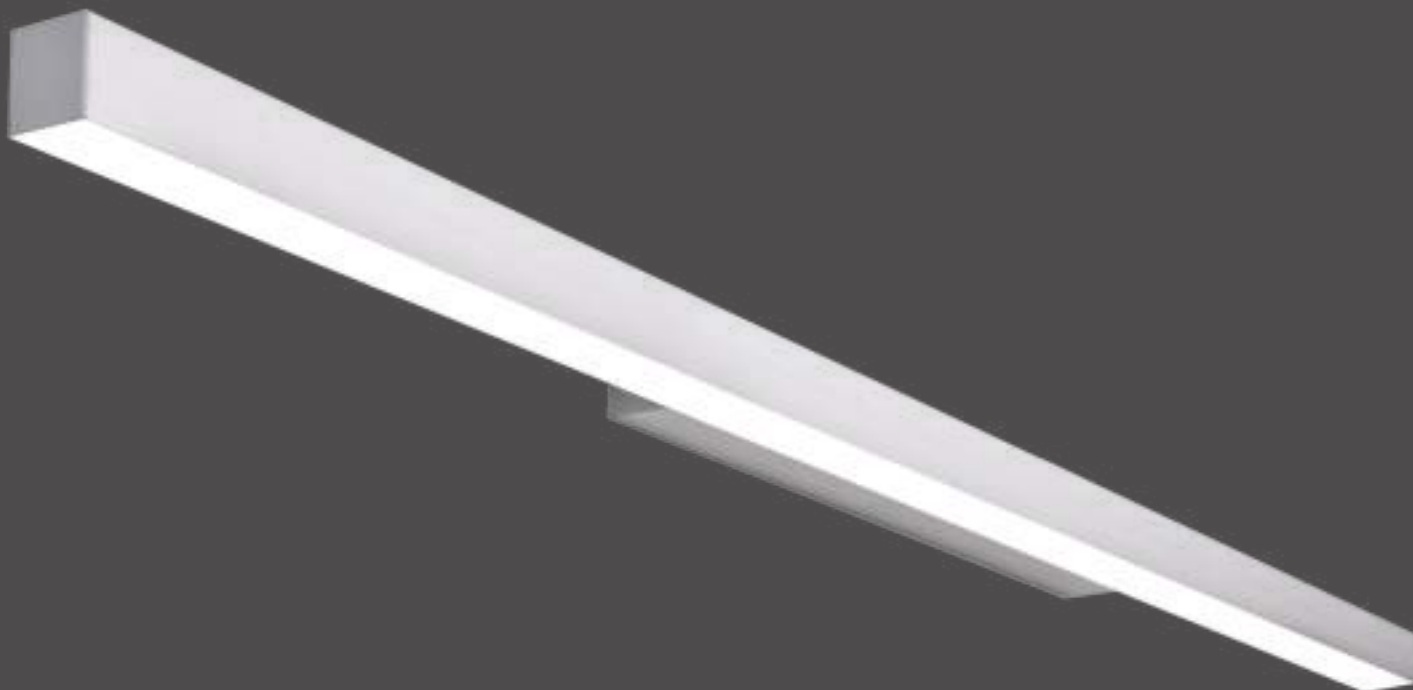

### PT

- > Luminária de parede com emissão direta ou indireta do fluxo luminoso.
- > Emissão direta ou indireta é definida pelo modo de aplicação.
- > Difusor PMMA Opal para iluminação homogénea, difusa e eficiente.
- > Corpo em perfil de alumínio extrudido.
- > Inclui topos injetados e sem parafusos.

### ES

- > Luminaria de pared con emisión directa o indirecta del flujo luminoso.
- > Emisión directa o indirecta es definida en la aplicación.
- > Difusor PMMA Opal.
- > Cuerpo en perfil de aluminio extruido.
- > Incluye tapas finales inyectadas y sin tornillos.

DIRECT LIGHT



INDIRECT LIGHT



**QUICK INFO**

**GENERAL**

Wall  
 IP40  
 IK04  
 750°C  
 Class I  
 Ta= -20°C +35°C

**OPTIC**

Opal PMMA

**LED**

Efficacy up to 188 lm/W  
 3000 K, 4000 K  
 CRI >80  
 Lifetime 72 000 H  
 L80/B10 @Tc=65°C

**ELETRICAL SYSTEM**

230V/50Hz  
 ON/OFF, DALI

**FINISHING**

RAL 9003 Matt White  
 Matt Anodized

**OPTIONS**

**LED**

2700 K, 5000 K, 6500 K  
 Tunable White, RGB, RGBW  
 CRI >90

**ELECTRICAL SYSTEM**

DSI, DIM 1-10V, Phase-cut

**CONTROL SYSTEM**

Bluetooth

**FINISHING**

 Other Colours

**SENSORS**

Motion  
 Ambient Light  
 Motion & AmbientLight

**SNAP WALL - DIRECT OR INDIRECT LIGHT**

**OPAL DIFFUSER**

**MATT WHITE FINISHING**

c (mm)	Output (lm)	System (W)	ON/OFF	DALI
<b>3000 K</b>				
590	1062	12	33.42.33.40.004	33.42.33.40.012
871	1593	18	33.42.33.40.005	33.42.33.40.013
1152	2124	24	33.42.33.40.006	33.42.33.40.014
1433	2655	30	33.42.33.40.007	33.42.33.40.015
<b>4000 K</b>				
590	1111	12	33.42.33.40.020	33.42.33.40.028
871	1666	18	33.42.33.40.021	33.42.33.40.029
1152	2222	24	33.42.33.40.022	33.42.33.40.030
1433	2777	30	33.42.33.40.023	33.42.33.40.031

**MATT ANODIZED FINISHING**

c (mm)	Output (lm)	System (W)	ON/OFF	DALI
<b>3000 K</b>				
590	1062	12	33.42.33.40.000	33.42.33.40.008
871	1593	18	33.42.33.40.001	33.42.33.40.009
1152	2124	24	33.42.33.40.002	33.42.33.40.010
1433	2655	30	33.42.33.40.003	33.42.33.40.011
<b>4000 K</b>				
590	1111	12	33.42.33.40.016	33.42.33.40.024
871	1666	18	33.42.33.40.017	33.42.33.40.025
1152	2222	24	33.42.33.40.018	33.42.33.40.026
1433	2777	30	33.42.33.40.019	33.42.33.40.027

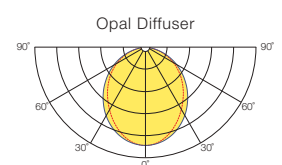

# SNAP

DIRECT & INDIRECT LIGHT

## WALL



### PT

- > Luminária de parede com emissão direta (70%) e indireta (30%) do fluxo.
- > Difusor PMMA Opal para iluminação homogénea, difusa e eficiente.
- > Corpo em perfil de alumínio extrudido.
- > Inclui topos injetados e sem parafusos.

### ES

- > Luminaria de pared con emisión directa (70%) e indirecta (30%) del flujo.
- > Difusor PMMA Opal.
- > Cuerpo en perfil de aluminio extruido.
- > Incluye tapas finales inyectadas y sin tornillos.

DIRECT & INDIRECT LIGHT





**QUICK INFO**

**GENERAL**

Wall  
 IP40  
 750°C  
 Class I  
 Ta= -20°C +35°C

**OPTIC**

Opal PMMA

**LED**

Efficacy up to 188 lm/W  
 3000 K, 4000 K  
 CRI >80  
 Lifetime 72 000 H  
 L80/B10 @TC=65°C

**ELETRICAL SYSTEM**

230V/50Hz  
 ON/OFF  
 Direct / Indirect - Simultaneous Control

**FINISHING**

RAL 9003 Matt White  
 Matt Anodized

**OPTIONS**

**LED**

2700 K, 5000 K, 6500 K  
 Tunable White, RGB, RGBW  
 CRI >90

**ELECTRICAL SYSTEM**

DALI, DSI, DIM 1-10V, Phase-cut  
 Direct / Indirect - Separate Control

**CONTROL SYSTEM**

Bluetooth

**FINISHING**

 Other Colours

**SENSORS**

Motion  
 Ambient Light  
 Motion & Ambient Light

**SNAP WALL - DIRECT & INDIRECT LIGHT  
 OPAL DIFFUSER**

**MATT WHITE FINISHING**

c (mm)	Output (lm)	System (W)	ON/OFF
<b>3000 K</b>			
854	2124	24	33.42.33.41.003
1136	3186	36	33.42.33.41.004
1417	4248	48	33.42.33.41.005
<b>4000 K</b>			
854	2222	24	33.42.33.41.009
1136	3332	36	33.42.33.41.010
1417	4443	48	33.42.33.41.011

**MATT ANODIZED FINISHING**

c (mm)	Output (lm)	System (W)	ON/OFF
<b>3000 K</b>			
854	2124	24	33.42.33.41.000
1136	3186	36	33.42.33.41.001
1417	4248	48	33.42.33.41.002
<b>4000 K</b>			
854	2222	24	33.42.33.41.006
1136	3332	36	33.42.33.41.007
1417	4443	48	33.42.33.41.008

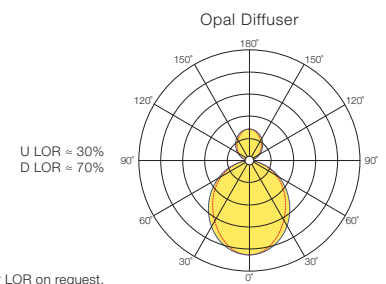
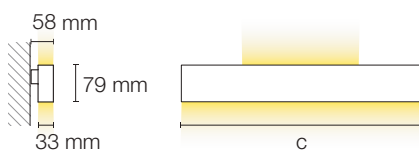

**WELINE** DIRECT LIGHT  
SUSPENDED





> **WELINE** SUSPENDED

# WELINE DIRECT LIGHT SUSPENDED



OPAL or  
MICRO PRISMATIC

## PT

- > Sistema modular de iluminação com emissão direta do fluxo luminoso.
- > De aplicação suspensa por cabos de aço inox com ajuste rápido da altura.
- > Pode ser usado como luminária individual, sistema em linha contínua ou formas geométricas.
- > Cantos iluminados que permitem luz uniforme sem interrupções em linhas contínuas com mudanças de direção a 90°.
- > Difusor Policarbonato Microprismático para controlo do encandeamento (UGR <19) ou difusor Policarbonato Opal.
- > Corpo em perfil de alumínio extrudido.
- > Topos injetados e sem parafusos.

## ES

- > Sistema modular de iluminación con emisión directa del flujo luminoso.
- > De aplicación suspendida por cables de acero inoxidable con regulación de la altura.
- > Se puede usar como luminaria individual, sistema en línea continua o formas geométricas.
- > Esquinas iluminadas aseguran luz uniforme sin interrupciones en las líneas continuas con cambios de dirección de 90°.
- > Difusor Policarbonato Microprismático para control del deslumbramiento (UGR <19) o difusor Policarbonato Opal.
- > Cuerpo en perfil de aluminio extrudido.
- > Tapas finales inyectadas y sin tornillos.

**QUICK INFO**

**GENERAL**

Suspended  
 IP40  
 IK05  
 850°C  
 Class I  
 Ta= -20°C +35°C

**OPTIC**

Opal Polycarbonate

**LED**

Efficacy up to 172 lm/W  
 3000 K, 4000 K  
 CRI >80  
 Lifetime 72 000 H  
 L80/B10 @Tc=70°C

**ELECTRICAL SYSTEM**

230V/50Hz  
 ON/OFF, DALI

**FINISHING**

RAL 9003 Matt White

**OPTIONS**

**LED**

2700 K, 5000 K, 6500 K  
 Tunable White, RGB, RGBW  
 CRI >90

**ELECTRICAL SYSTEM**

DSI, DIM 1-10V, Phase-cut

**CONTROL SYSTEM**

Bluetooth

**FINISHING**

 Other Colours

**EMERGENCY**

1 Hour, 3 Hours  
 DALI 1 Hour, 3 Hours

**SENSORS**

Motion  
 Ambient Light  
 Motion & Ambient Light

**WELINE SUSPENDED - DIRECT LIGHT**

**OPAL DIFFUSER**

**MATT WHITE FINISHING**

c (mm)	Output (lm)	System (W)	ON/OFF	DALI
<b>3000 K</b>				
564	1241	13	33.42.55.00.012	33.42.55.00.072
	2480	25	33.42.55.00.018	33.42.55.00.078
845	1860	19	33.42.55.00.013	33.42.55.00.073
	3720	38	33.42.55.00.019	33.42.55.00.079
1126	2480	25	33.42.55.00.014	33.42.55.00.074
	4961	50	33.42.55.00.020	33.42.55.00.080
1407	3100	31	33.42.55.00.015	33.42.55.00.075
	6201	63	33.42.55.00.021	33.42.55.00.081
2250	4959	50	33.42.55.00.016	33.42.55.00.076
	9921	101	33.42.55.00.022	33.42.55.00.082
2812	6200	63	33.42.55.00.017	33.42.55.00.077
	12401	126	33.42.55.00.023	33.42.55.00.083
Corner 600x600	2480	25	33.42.55.00.502	33.42.55.00.512
	4961	50	33.42.55.00.503	33.42.55.00.513
<b>4000 K</b>				
564	1298	13	33.42.55.00.132	33.42.55.00.192
	2595	25	33.42.55.00.138	33.42.55.00.198
845	1947	19	33.42.55.00.133	33.42.55.00.193
	3893	38	33.42.55.00.139	33.42.55.00.199
1126	2595	25	33.42.55.00.134	33.42.55.00.194
	5190	50	33.42.55.00.140	33.42.55.00.200
1407	3244	31	33.42.55.00.135	33.42.55.00.195
	6488	63	33.42.55.00.141	33.42.55.00.201
2250	5190	50	33.42.55.00.136	33.42.55.00.196
	10381	101	33.42.55.00.142	33.42.55.00.202
2812	6489	63	33.42.55.00.137	33.42.55.00.197
	12976	126	33.42.55.00.143	33.42.55.00.203
Corner 600x600	2595	25	33.42.55.00.522	33.42.55.00.532
	5190	50	33.42.55.00.523	33.42.55.00.533

> Fluorescent lamp versions also available – product data at [www.climarlighting.com](http://www.climarlighting.com) – or by direct request to the factory.

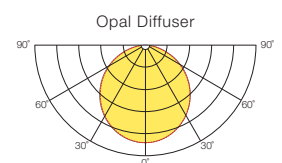
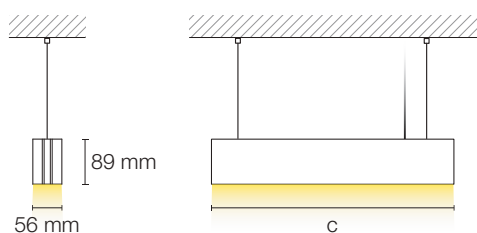

**QUICK INFO**

**GENERAL**

Suspended  
 IP40  
 IK05  
 850°C  
 Class I  
 Ta= -20°C +35°C

**OPTIC**

Opal Polycarbonate

**LED**

Efficacy up to 172 lm/W  
 3000 K, 4000 K  
 CRI >80  
 Lifetime 72 000 H  
 L80/B10 @Tc=70°C

**ELECTRICAL SYSTEM**

230V/50Hz  
 ON/OFF, DALI

**FINISHING**

Matt Anodized

**OPTIONS**

**LED**

2700 K, 5000 K, 6500 K  
 Tunable White, RGB, RGBW  
 CRI >90

**ELECTRICAL SYSTEM**

DSI, DIM 1-10V, Phase-cut

**CONTROL SYSTEM**

Bluetooth

**FINISHING**

 Other Colours

**EMERGENCY**

1 Hour, 3 Hours  
 DALI 1 Hour, 3 Hours

**SENSORS**

Motion  
 Ambient Light  
 Motion & Ambient Light

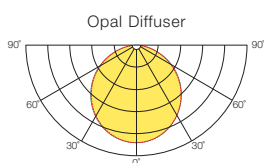

**WELINE SUSPENDED - DIRECT LIGHT**

**OPAL DIFFUSER**

**MATT ANODIZED FINISHING**

c (mm)	Output (lm)	System (W)	ON/OFF	DALI
<b>3000 K</b>				
564	1241	13	33.42.55.00.000	33.42.55.00.060
	2480	25	33.42.55.00.006	33.42.55.00.066
845	1860	19	33.42.55.00.001	33.42.55.00.061
	3720	38	33.42.55.00.007	33.42.55.00.067
1126	2480	25	33.42.55.00.002	33.42.55.00.062
	4961	50	33.42.55.00.008	33.42.55.00.068
1407	3100	31	33.42.55.00.003	33.42.55.00.063
	6201	63	33.42.55.00.009	33.42.55.00.069
2250	4959	50	33.42.55.00.004	33.42.55.00.064
	9921	101	33.42.55.00.010	33.42.55.00.070
2812	6200	63	33.42.55.00.005	33.42.55.00.065
	12401	126	33.42.55.00.011	33.42.55.00.071
Corner 600x600	2480	25	33.42.55.00.500	33.42.55.00.510
	4961	50	33.42.55.00.501	33.42.55.00.511
<b>4000 K</b>				
564	1298	13	33.42.55.00.120	33.42.55.00.180
	2595	25	33.42.55.00.126	33.42.55.00.186
845	1947	19	33.42.55.00.121	33.42.55.00.181
	3893	38	33.42.55.00.127	33.42.55.00.187
1126	2595	25	33.42.55.00.122	33.42.55.00.182
	5190	50	33.42.55.00.128	33.42.55.00.188
1407	3244	31	33.42.55.00.123	33.42.55.00.183
	6488	63	33.42.55.00.129	33.42.55.00.189
2250	5190	50	33.42.55.00.124	33.42.55.00.184
	10381	101	33.42.55.00.130	33.42.55.00.190
2812	6489	63	33.42.55.00.125	33.42.55.00.185
	12976	126	33.42.55.00.131	33.42.55.00.191
Corner 600x600	2595	25	33.42.55.00.520	33.42.55.00.530
	5190	50	33.42.55.00.521	33.42.55.00.531

> Fluorescent lamp versions also available – product data at [www.climarlighting.com](http://www.climarlighting.com) – or by direct request to the factory.

**DESCRIPTION**

- 1 > DRIVER
- 2 > LED BOARD
- 3 > LED COVER
- 4 > REFLECTOR
- 5 > DIFFUSER
- 6 > SUSPENSION



**QUICK INFO**

**GENERAL**

Suspended  
 IP40  
 IK05  
 850°C  
 Class I  
 Ta= -20°C +35°C

**OPTIC**

Micro Prismatic Polycarbonate  
 UGR <19

**LED**

Efficacy up to 182 lm/W  
 3000 K, 4000 K  
 CRI >80  
 Lifetime 72 000 H  
 L80/B10 @Tc=70°C

**ELETRICAL SYSTEM**

230V/50Hz  
 ON/OFF, DALI

**FINISHING**

RAL 9003 Matt White

**OPTIONS**

**LED**

2700 K, 5000 K, 6500 K  
 Tunable White, RGB, RGBW  
 CRI >90

**ELECTRICAL SYSTEM**

DSI, DIM 1-10V, Phase-cut

**CONTROL SYSTEM**

Bluetooth

**FINISHING**

 Other Colours

**EMERGENCY**

1 Hour, 3 Hours  
 DALI 1 Hour, 3 Hours

**SENSORS**

Motion  
 Ambient Light  
 Motion & Ambient Light

**WELINE SUSPENDED - DIRECT LIGHT  
 MICRO PRISMATIC DIFFUSER - UGR <19**

**MATT WHITE FINISHING**

c (mm)	Output (lm)	System (W)	ON/OFF	DALI
<b>3000 K</b>				
	506	7	33.42.55.00.054	33.42.55.00.114
564	816	13	33.42.55.00.042	33.42.55.00.102
	1630	25	33.42.55.00.048	33.42.55.00.108
845	759	11	33.42.55.00.055	33.42.55.00.115
	1223	19	33.42.55.00.043	33.42.55.00.103
1126	2446	38	33.42.55.00.049	33.42.55.00.109
	1012	15	33.42.55.00.056	33.42.55.00.116
1407	1630	25	33.42.55.00.044	33.42.55.00.104
	3262	50	33.42.55.00.050	33.42.55.00.110
2250	1265	18	33.42.55.00.057	33.42.55.00.117
	2038	31	33.42.55.00.045	33.42.55.00.105
2812	4077	63	33.42.55.00.051	33.42.55.00.111
	2023	29	33.42.55.00.058	33.42.55.00.118
Corner 600x600	3261	50	33.42.55.00.046	33.42.55.00.106
	6523	101	33.42.55.00.052	33.42.55.00.112
4000 K	2529	37	33.42.55.00.059	33.42.55.00.119
	4076	63	33.42.55.00.047	33.42.55.00.107
Corner 600x600	8154	126	33.42.55.00.053	33.42.55.00.113
	1012	15	33.42.55.00.509	33.42.55.00.519
564	1630	25	33.42.55.00.507	33.42.55.00.517
	3262	50	33.42.55.00.508	33.42.55.00.518
	529	7	33.42.55.00.174	33.42.55.00.234
845	854	13	33.42.55.00.162	33.42.55.00.222
	1706	25	33.42.55.00.168	33.42.55.00.228
1126	794	11	33.42.55.00.175	33.42.55.00.235
	1280	19	33.42.55.00.163	33.42.55.00.223
1407	2559	38	33.42.55.00.169	33.42.55.00.229
	1058	15	33.42.55.00.176	33.42.55.00.236
2250	1706	25	33.42.55.00.164	33.42.55.00.224
	3413	50	33.42.55.00.170	33.42.55.00.230
2812	1323	18	33.42.55.00.177	33.42.55.00.237
	2133	31	33.42.55.00.165	33.42.55.00.225
Corner 600x600	4266	63	33.42.55.00.171	33.42.55.00.231
	2117	29	33.42.55.00.178	33.42.55.00.238
564	3413	50	33.42.55.00.166	33.42.55.00.226
	6825	101	33.42.55.00.172	33.42.55.00.232
845	2646	37	33.42.55.00.179	33.42.55.00.239
	4266	63	33.42.55.00.167	33.42.55.00.227
1126	8532	126	33.42.55.00.173	33.42.55.00.233
	1058	15	33.42.55.00.527	33.42.55.00.539
1407	1706	25	33.42.55.00.528	33.42.55.00.537
	3413	50	33.42.55.00.529	33.42.55.00.538

Micro Prismatic Diffuser - UGR<19

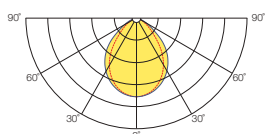

**QUICK INFO**

**GENERAL**

Suspended  
 IP40  
 IK05  
 850°C  
 Class I  
 Ta= -20°C +35°C

**OPTIC**

Micro Prismatic Polycarbonate  
 UGR <19

**LED**

Efficacy up to 182 lm/W  
 3000 K, 4000 K  
 CRI >80  
 Lifetime 72 000 H  
 L80/B10 @Tc=70°C

**ELETRICAL SYSTEM**

230V/50Hz  
 ON/OFF, DALI

**FINISHING**

Matt Anodized

**OPTIONS**

**LED**

2700 K, 5000 K, 6500 K  
 Tunable White, RGB, RGBW  
 CRI >90

**ELECTRICAL SYSTEM**

DSI, DIM 1-10V, Phase-cut

**CONTROL SYSTEM**

Bluetooth

**FINISHING**

 Other Colours

**EMERGENCY**

1 Hour, 3 Hours  
 DALI 1 Hour, 3 Hours

**SENSORS**

Motion  
 Ambient Light  
 Motion & Ambient Light

**WELINE SUSPENDED - DIRECT LIGHT**

**MICRO PRISMATIC DIFFUSER - UGR <19**

**MATT ANODIZED FINISHING**

c (mm)	Output (lm)	System (W)	ON/OFF	DALI
<b>3000 K</b>				
	506	7	33.42.55.00.036	33.42.55.00.096
564	816	13	33.42.55.00.024	33.42.55.00.084
	1630	25	33.42.55.00.030	33.42.55.00.090
845	759	11	33.42.55.00.037	33.42.55.00.097
	1223	19	33.42.55.00.025	33.42.55.00.085
1126	2446	38	33.42.55.00.031	33.42.55.00.091
	1012	15	33.42.55.00.038	33.42.55.00.098
1407	1630	25	33.42.55.00.026	33.42.55.00.086
	3262	50	33.42.55.00.032	33.42.55.00.092
2250	1265	18	33.42.55.00.039	33.42.55.00.099
	2038	31	33.42.55.00.027	33.42.55.00.087
2812	4077	63	33.42.55.00.033	33.42.55.00.093
	2023	29	33.42.55.00.040	33.42.55.00.100
Corner 600x600	3261	50	33.42.55.00.028	33.42.55.00.088
	6523	101	33.42.55.00.034	33.42.55.00.094
Corner 600x600	2529	37	33.42.55.00.041	33.42.55.00.101
	4076	63	33.42.55.00.029	33.42.55.00.089
Corner 600x600	8154	126	33.42.55.00.035	33.42.55.00.095
	1012	15	33.42.55.00.506	33.42.55.00.516
Corner 600x600	1630	25	33.42.55.00.504	33.42.55.00.514
	3262	50	33.42.55.00.505	33.42.55.00.515
<b>4000 K</b>				
	529	7	33.42.55.00.156	33.42.55.00.216
564	854	13	33.42.55.00.144	33.42.55.00.204
	1706	25	33.42.55.00.150	33.42.55.00.210
845	794	11	33.42.55.00.157	33.42.55.00.217
	1280	19	33.42.55.00.145	33.42.55.00.205
1126	2559	38	33.42.55.00.151	33.42.55.00.211
	1058	15	33.42.55.00.158	33.42.55.00.218
1407	1706	25	33.42.55.00.146	33.42.55.00.206
	3413	50	33.42.55.00.152	33.42.55.00.212
2250	1323	18	33.42.55.00.159	33.42.55.00.219
	2133	31	33.42.55.00.147	33.42.55.00.207
2812	4266	63	33.42.55.00.153	33.42.55.00.213
	2117	29	33.42.55.00.160	33.42.55.00.220
Corner 600x600	3413	50	33.42.55.00.148	33.42.55.00.208
	6825	101	33.42.55.00.154	33.42.55.00.214
Corner 600x600	2646	37	33.42.55.00.161	33.42.55.00.221
	4266	63	33.42.55.00.149	33.42.55.00.209
Corner 600x600	8532	126	33.42.55.00.155	33.42.55.00.215
	1058	15	33.42.55.00.526	33.42.55.00.536
Corner 600x600	1706	25	33.42.55.00.524	33.42.55.00.534
	3413	50	33.42.55.00.525	33.42.55.00.535

Micro Prismatic Diffuser - UGR<19

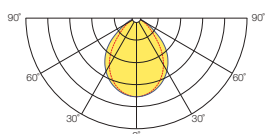



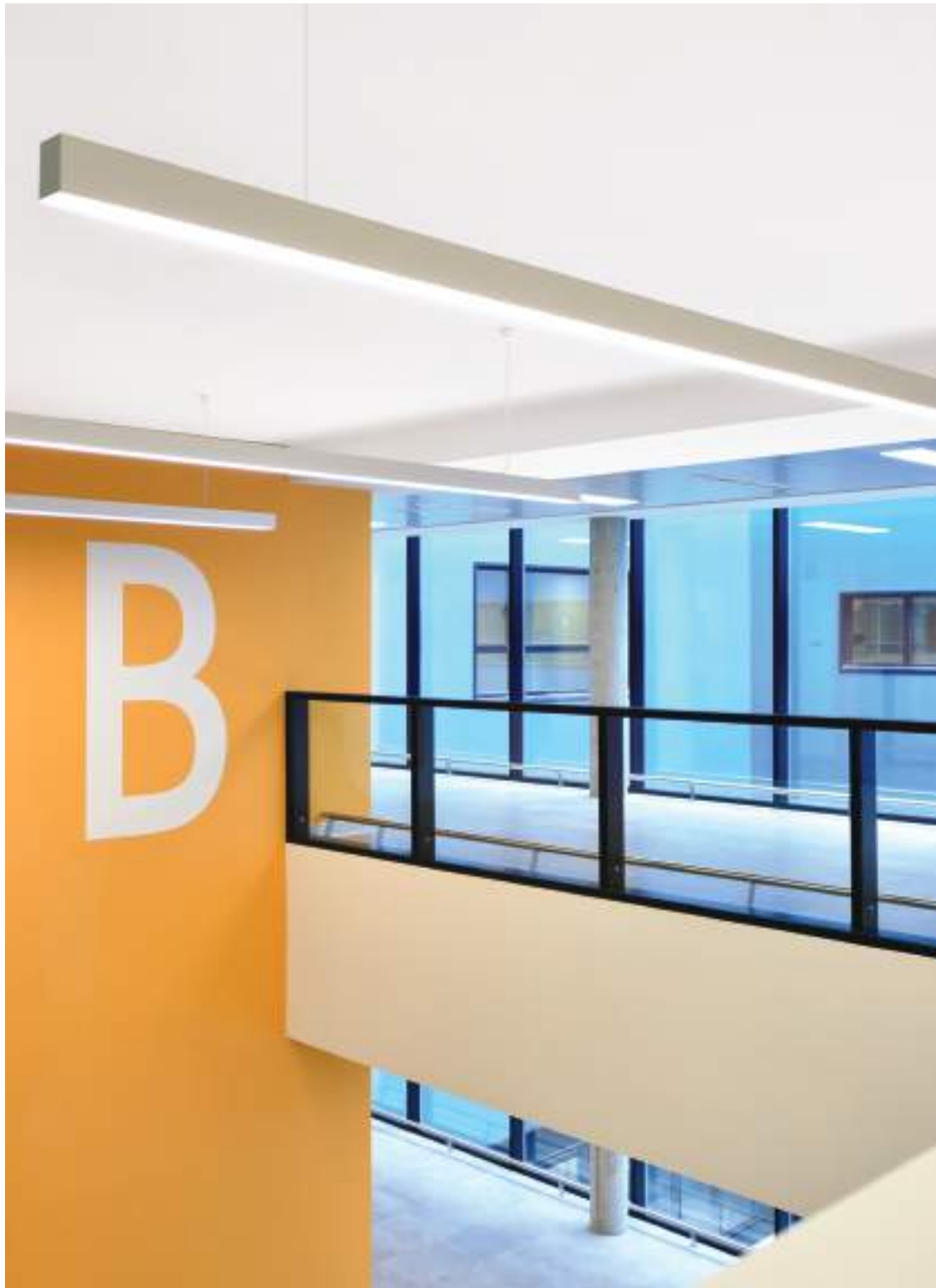

> **WELINE** SUSPENDED

# WELINE DIRECT LIGHT SUSPENDED

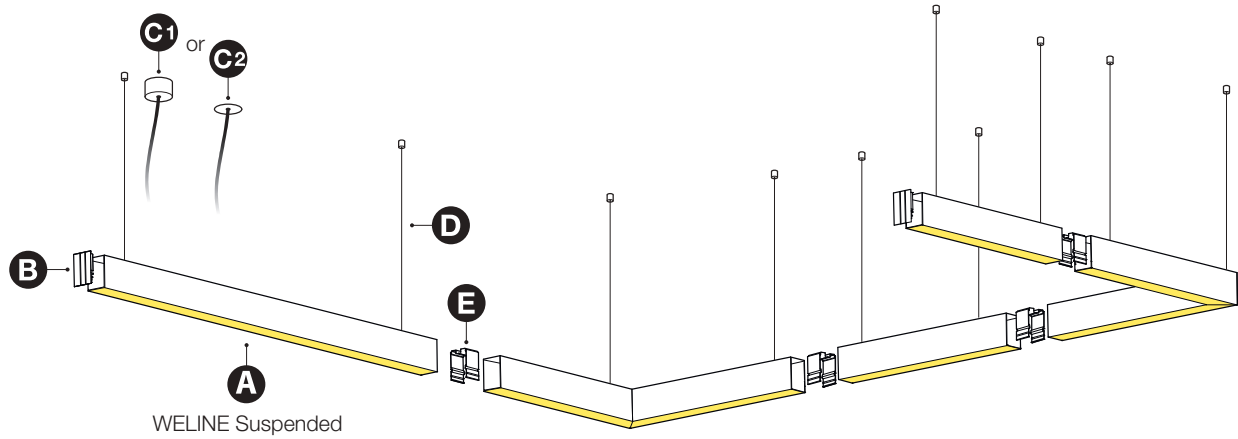

## COMPONENTS



### **B** END CAP (1pc)

	<b>COD</b>
Matt White	35.42.55.00.000
Matt Anodized Similar Painting	35.42.55.00.001



### **C1** SURFACE CEILING CUP (1pc)

MATT WHITE	DIMENSION	1m	3m	5m
ON/OFF	Ø62x36 mm	35.42.001.01.80	35.42.001.01.88	35.42.001.01.96
ON/OFF + EM	Ø62x36 mm	35.42.001.01.81	35.42.001.01.89	35.42.001.01.97
DALI	Ø62x36 mm	35.42.001.01.82	35.42.001.01.90	35.42.001.01.98
DALI + EM	Ø103x36 mm	35.42.001.01.83	35.42.001.01.91	35.42.001.01.99



### **C2** RECESSED CEILING CUP (1pc)

MATT WHITE	DIMENSION	1m	3m	5m
ON/OFF	Ø80 mm	35.42.001.01.84	35.42.001.01.92	35.42.002.01.00
ON/OFF + EM	Ø80 mm	35.42.001.01.85	35.42.001.01.93	35.42.002.01.01
DALI	Ø80 mm	35.42.001.01.86	35.42.001.01.94	35.42.002.01.02
DALI + EM	Ø80 mm	35.42.001.01.87	35.42.001.01.95	35.42.002.01.03



### **D** SUSPENSION SYSTEM (2pcs)

TYPE	1m	3m	5m
Matt White + Stainless Steel Cable	35.42.000.01.54	35.42.000.01.62	35.42.001.01.26



### **E** LINEAR COUPLER (1pc)

	<b>COD</b>
Coupler	35.42.55.00.005

OPTIONS



**EMERGENCY (EM) - SELF-TEST INTEGRATED**

ON/OFF	COD
EM 1H 3W	35.00.003.01.23*
EM 3H 3W	35.00.003.01.24**
DALI	COD
EM 1H 5,4W DALI	35.00.004.01.54*
EM 3H 5,4W DALI	35.00.004.01.55**

\* Applies to lengths equal to or greater than 1126 mm. \*\* Applies to lengths equal to or greater than 1407 mm.  
 > On request – External Emergency. Box dimensions: 45x120x360 mm.



# WELINE IP54 DIRECT LIGHT SUSPENDED

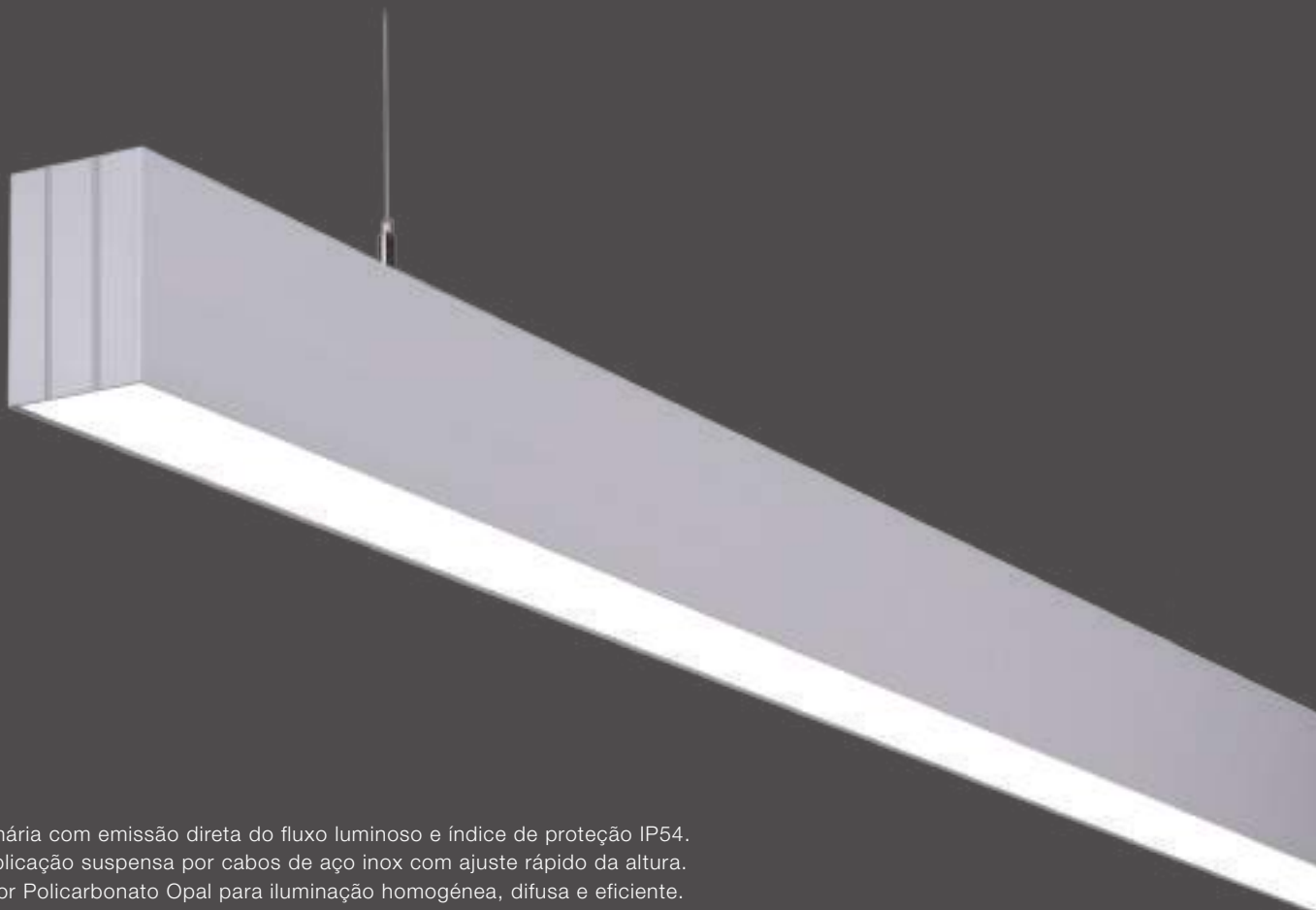

## PT

- > Luminária com emissão direta do fluxo luminoso e índice de proteção IP54.
- > De aplicação suspensa por cabos de aço inox com ajuste rápido da altura.
- > Difusor Policarbonato Opal para iluminação homogénea, difusa e eficiente.
- > Corpo em perfil de alumínio extrudido.
- > Inclui topos injetados e sem parafusos.

## ES

- > Luminaria con emisión directa del flujo luminoso y grado de protección IP54.
- > De aplicación suspendida por cables de acero inoxidable con regulación de la altura.
- > Difusor Policarbonato Opal.
- > Cuerpo en perfil de aluminio extruido.
- > Incluye tapas finales inyectadas y sin tornillos.

**QUICK INFO**

**GENERAL**

Suspended  
 IP54  
 IK05  
 850°C  
 Class I  
 Ta= -20°C +35°C

**OPTIC**

Opal Polycarbonate

**LED**

Efficacy up to 172 lm/W  
 3000 K, 4000 K  
 CRI >80  
 Lifetime 72 000 H  
 L80/B10 @Tc=70°C

**ELECTRICAL SYSTEM**

230V/50Hz  
 ON/OFF, DALI

**FINISHING**

RAL 9003 Matt White

**OPTIONS**

**LED**

2700 K, 5000 K, 6500 K  
 Tunable White, RGB, RGBW  
 CRI >90

**ELECTRICAL SYSTEM**

DSI, DIM 1-10V, Phase-cut

**CONTROL SYSTEM**

Bluetooth

**FINISHING**

 Other Colours

**EMERGENCY**

1 Hour, 3 Hours  
 DALI 1 Hour, 3 Hours

**SENSORS**

Motion  
 Ambient Light  
 Motion & Ambient Light

**WELINE IP54 SUSPENDED - DIRECT LIGHT  
 OPAL DIFFUSER**

**MATT WHITE FINISHING**

c (mm)	Output (lm)	System (W)	ON/OFF	DALI
<b>3000 K</b>				
570	979	13	33.42.55.01.012	33.42.55.01.060
	1957	25	33.42.55.01.018	33.42.55.01.066
850	1468	19	33.42.55.01.013	33.42.55.01.061
	2936	38	33.42.55.01.019	33.42.55.01.067
1131	1957	25	33.42.55.01.014	33.42.55.01.062
	3915	50	33.42.55.01.020	33.42.55.01.068
1412	2446	31	33.42.55.01.015	33.42.55.01.063
	4893	63	33.42.55.01.021	33.42.55.01.069
2252	3914	50	33.42.55.01.016	33.42.55.01.064
	7830	101	33.42.55.01.022	33.42.55.01.070
2817	4893	63	33.42.55.01.017	33.42.55.01.065
	9787	126	33.42.55.01.023	33.42.55.01.071
<b>4000 K</b>				
570	1025	13	33.42.55.01.108	33.42.55.01.156
	2048	25	33.42.55.01.114	33.42.55.01.162
850	1536	19	33.42.55.01.109	33.42.55.01.157
	3072	38	33.42.55.01.115	33.42.55.01.163
1131	2048	25	33.42.55.01.110	33.42.55.01.158
	4096	50	33.42.55.01.116	33.42.55.01.164
1412	2560	31	33.42.55.01.111	33.42.55.01.159
	5120	63	33.42.55.01.117	33.42.55.01.165
2252	4096	50	33.42.55.01.112	33.42.55.01.160
	8192	101	33.42.55.01.118	33.42.55.01.166
2817	5121	63	33.42.55.01.113	33.42.55.01.161
	10240	126	33.42.55.01.119	33.42.55.01.167

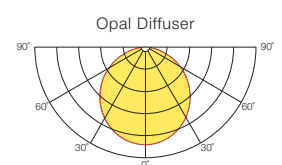
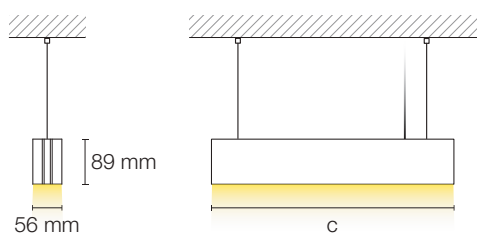

**QUICK INFO**

**GENERAL**

Suspended  
 IP54  
 IK05  
 850°C  
 Class I  
 Ta= -20°C +35°C

**OPTIC**

Opal Polycarbonate

**LED**

Efficacy up to 172 lm/W  
 3000 K, 4000 K  
 CRI >80  
 Lifetime 72 000 H  
 L80/B10 @Tc=70°C

**ELETRICAL SYSTEM**

230V/50Hz  
 ON/OFF, DALI

**FINISHING**

Matt Anodized

**OPTIONS**

**LED**

2700 K, 5000 K, 6500 K  
 Tunable White, RGB, RGBW  
 CRI >90

**ELECTRICAL SYSTEM**

DSI, DIM 1-10V, Phase-cut

**CONTROL SYSTEM**

Bluetooth

**FINISHING**

 Other Colours

**EMERGENCY**

1 Hour, 3 Hours  
 DALI 1 Hour, 3 Hours

**SENSORS**

Motion  
 Ambient Light  
 Motion & Ambient Light

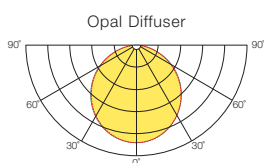

**WELINE IP54 SUSPENDED - DIRECT LIGHT  
 OPAL DIFFUSER**

**MATT ANODIZED FINISHING**

c (mm)	Output (lm)	System (W)	ON/OFF	DALI
<b>3000 K</b>				
570	979	13	33.42.55.01.000	33.42.55.01.048
	1957	25	33.42.55.01.006	33.42.55.01.054
850	1468	19	33.42.55.01.001	33.42.55.01.049
	2936	38	33.42.55.01.007	33.42.55.01.055
1131	1957	25	33.42.55.01.002	33.42.55.01.050
	3915	50	33.42.55.01.008	33.42.55.01.056
1412	2446	31	33.42.55.01.003	33.42.55.01.051
	4893	63	33.42.55.01.009	33.42.55.01.057
2252	3914	50	33.42.55.01.004	33.42.55.01.052
	7830	101	33.42.55.01.010	33.42.55.01.058
2817	4893	63	33.42.55.01.005	33.42.55.01.053
	9787	126	33.42.55.01.011	33.42.55.01.059
<b>4000 K</b>				
570	1025	13	33.42.55.01.096	33.42.55.01.144
	2048	25	33.42.55.01.102	33.42.55.01.150
850	1536	19	33.42.55.01.097	33.42.55.01.145
	3072	38	33.42.55.01.103	33.42.55.01.151
1131	2048	25	33.42.55.01.098	33.42.55.01.146
	4096	50	33.42.55.01.104	33.42.55.01.152
1412	2560	31	33.42.55.01.099	33.42.55.01.147
	5120	63	33.42.55.01.105	33.42.55.01.153
2252	4096	50	33.42.55.01.100	33.42.55.01.148
	8192	101	33.42.55.01.106	33.42.55.01.154
2817	5121	63	33.42.55.01.101	33.42.55.01.149
	10240	126	33.42.55.01.107	33.42.55.01.155

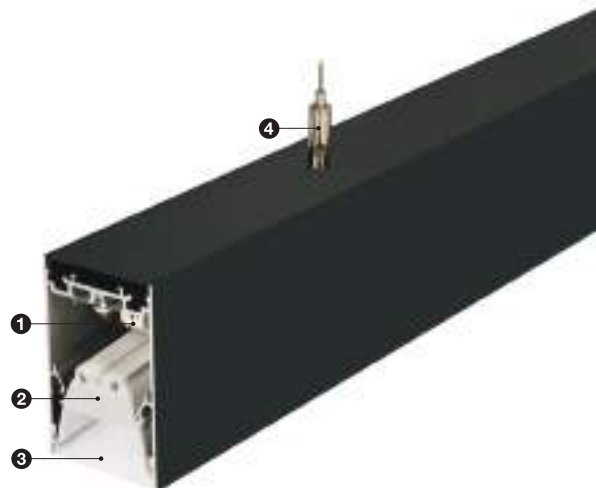

**DESCRIPTION**

- 1 > DRIVER
- 2 > REFLECTOR + LED BOARD
- 3 > DIFFUSER
- 4 > SUSPENSION

# WELINE IP54 DIRECT LIGHT SUSPENDED

## COMPONENTS



### SURFACE CEILING CUP (1pc)

MATT WHITE	DIMENSION	1 m	3 m	5 m
ON/OFF	Ø62x36 mm	35.42.001.01.80	35.42.001.01.88	35.42.001.01.96
ON/OFF + EM	Ø62x36 mm	35.42.001.01.81	35.42.001.01.89	35.42.001.01.97
DALI	Ø62x36 mm	35.42.001.01.82	35.42.001.01.90	35.42.001.01.98
DALI + EM	Ø103x36 mm	35.42.001.01.83	35.42.001.01.91	35.42.001.01.99



### RECESSED CEILING CUP (1pc)

MATT WHITE	DIMENSION	1 m	3 m	5 m
ON/OFF	Ø80 mm	35.42.001.01.84	35.42.001.01.92	35.42.002.01.00
ON/OFF + EM	Ø80 mm	35.42.001.01.85	35.42.001.01.93	35.42.002.01.01
DALI	Ø80 mm	35.42.001.01.86	35.42.001.01.94	35.42.002.01.02
DALI + EM	Ø80 mm	35.42.001.01.87	35.42.001.01.95	35.42.002.01.03



### SUSPENSION SYSTEM (2pcs)

TYPE	1 m	3 m	5 m
Matt White + Stainless Steel Cable	35.42.000.01.54	35.42.000.01.62	35.42.001.01.26

## OPTIONS



### EMERGENCY (EM) - SELF-TEST INTEGRATED

ON/OFF	COD
EM 1H 3W	35.00.003.01.23*
EM 3H 3W	35.00.003.01.24**
DALI	COD
EM 1H 5,4W DALI	35.00.004.01.54*
EM 3H 5,4W DALI	35.00.004.01.55**

\* Applies to lengths equal to or greater than 1131 mm. \*\* Applies to lengths equal to or greater than 1412 mm.  
> On request – External Emergency. Box dimensions: 45x120x360 mm.

# WELINE DIRECT & INDIRECT LIGHT SUSPENDED



OPAL or  
MICRO PRISMATIC

## PT

- > Sistema modular de iluminação com emissão direta (70%) e indireta (30%) do fluxo.
- > Aplicação suspensa por cabos de aço inox com ajuste da altura e da posição ao longo do comprimento da luminária.
- > Pode ser usado como luminária individual ou sistema em linha contínua.
- > Difusor luz direta em Policarbonato Microprismático para controlo do encandeamento (UGR <19) ou difusor Policarbonato Opal.
- > Difusor luz indireta em PMMA Opal otimizado para LED.
- > Corpo em perfil de alumínio extrudido.
- > Topos injetados e sem parafusos.

## ES

- > Sistema modular de iluminación con emisión directa (70%) e indirecta (30%) del flujo.
- > De aplicación suspendida por cables de acero inoxidable con regulación de la altura y de la posición en la longitud de la luminaria.
- > Se puede usar como luminaria individual o sistema en línea continua.
- > Difusor luz directa en Policarbonato Microprismático para control del deslumbramiento (UGR <19) o difusor Policarbonato Opal.
- > Difusor luz indirecta en PMMA Opal optimizado para LED.
- > Cuerpo en perfil de aluminio extrudido.
- > Tapas finales inyectadas y sin tornillos.

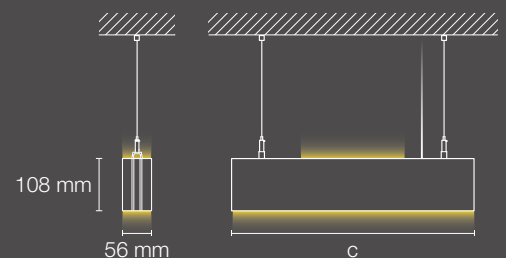



**QUICK INFO**

**GENERAL**

Suspended  
 IP40  
 IK05  
 750°C  
 Class I  
 Ta= -20°C +35°C

**OPTIC**

Opal Polycarbonate

**LED**

Efficacy up to 188 lm/W  
 3000 K, 4000 K  
 CRI >80  
 Lifetime 72 000 H  
 L80/B10 @Tc=75°C

**ELETRICAL SYSTEM**

230V/50Hz  
 ON/OFF, DALI  
 Direct / Indirect - Simultaneous Control

**FINISHING**

RAL 9003 Matt White  
 Matt Anodized

**OPTIONS**

**LED**

2700 K, 5000 K, 6500 K  
 Tunable White, RGB, RGBW  
 CRI >90

**ELECTRICAL SYSTEM**

DSI, DIM 1-10V, Phase-cut  
 Direct / Indirect - Separate Control

**CONTROL SYSTEM**

Bluetooth

**FINISHING**

 Other Colours

**EMERGENCY**

1 Hour, 3 Hours  
 DALI 1 Hour, 3 Hours

**SENSORS**

Motion  
 Ambient Light  
 Motion & Ambient Light

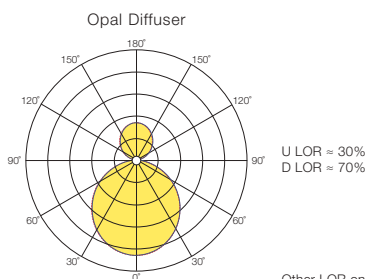

**WELINE SUSPENDED - DIRECT & INDIRECT LIGHT  
 OPAL DIFFUSER**

**MATT WHITE FINISHING**

c (mm)	Output (lm)	System (W)	ON/OFF	DALI
<b>3000 K</b>				
1126	3368	30	33.42.55.02.000	33.42.55.02.016
	6354	63	33.42.55.02.004	33.42.55.02.020
1407	4394	39	33.42.55.02.001	33.42.55.02.017
	8291	82	33.42.55.02.005	33.42.55.02.021
2250	6735	60	33.42.55.02.002	33.42.55.02.018
	12709	126	33.42.55.02.006	33.42.55.02.022
2812	8420	75	33.42.55.02.003	33.42.55.02.019
	15887	157	33.42.55.02.007	33.42.55.02.023
<b>4000 K</b>				
1126	3523	30	33.42.55.02.032	33.42.55.02.048
	6649	63	33.42.55.02.036	33.42.55.02.052
1407	4597	39	33.42.55.02.033	33.42.55.02.049
	8676	82	33.42.55.02.037	33.42.55.02.053
2250	7047	60	33.42.55.02.034	33.42.55.02.050
	13297	126	33.42.55.02.038	33.42.55.02.054
2812	8808	75	33.42.55.02.035	33.42.55.02.051
	16624	157	33.42.55.02.039	33.42.55.02.055

**MATT ANODIZED FINISHING**

c (mm)	Output (lm)	System (W)	ON/OFF	DALI
<b>3000 K</b>				
1126	3368	30	33.42.55.02.008	33.42.55.02.024
	6354	63	33.42.55.02.012	33.42.55.02.028
1407	4394	39	33.42.55.02.009	33.42.55.02.025
	8291	82	33.42.55.02.013	33.42.55.02.029
2250	6735	60	33.42.55.02.010	33.42.55.02.026
	12709	126	33.42.55.02.014	33.42.55.02.030
2812	8420	75	33.42.55.02.011	33.42.55.02.027
	15887	157	33.42.55.02.015	33.42.55.02.031
<b>4000 K</b>				
1126	3523	30	33.42.55.02.040	33.42.55.02.056
	6649	63	33.42.55.02.044	33.42.55.02.060
1407	4597	39	33.42.55.02.041	33.42.55.02.057
	8676	82	33.42.55.02.045	33.42.55.02.061
2250	7047	60	33.42.55.02.042	33.42.55.02.058
	13297	126	33.42.55.02.046	33.42.55.02.062
2812	8808	75	33.42.55.02.043	33.42.55.02.059
	16624	157	33.42.55.02.047	33.42.55.02.063

**QUICK INFO**

**GENERAL**

Suspended  
 IP40  
 IK05  
 750°C  
 Class I  
 Ta= -20°C +35°C

**OPTIC**

Micro Prismatic PC - UGR <19

**LED**

Efficacy up to 188 lm/W  
 3000 K, 4000 K  
 CRI >80  
 Lifetime 72 000 H  
 L80/B10 @Tc=75°C

**ELETRICAL SYSTEM**

230V/50Hz  
 ON/OFF, DALI  
 Direct / Indirect - Simultaneous Control

**FINISHING**

RAL 9003 Matt White  
 Matt Anodized

**OPTIONS**

**LED**

2700 K, 5000 K, 6500 K  
 Tunable White, RGB, RGBW  
 CRI >90

**ELECTRICAL SYSTEM**

DSI, DIM 1-10V, Phase-cut  
 Direct / Indirect - Separate Control

**CONTROL SYSTEM**

Bluetooth

**FINISHING**

 Other Colours

**EMERGENCY**

1 Hour, 3 Hours  
 DALI 1 Hour, 3 Hours

**SENSORS**

Motion  
 Ambient Light  
 Motion & Ambient Light

Micro Prismatic Diffuser - UGR<19

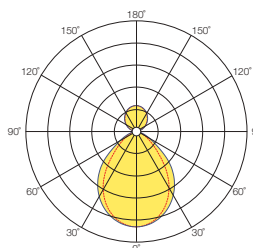

**WELINE SUSPENDED - DIRECT & INDIRECT LIGHT  
 MICRO PRISMATIC DIFFUSER - UGR <19**

**MATT WHITE FINISHING**

c (mm)	Output (lm)	System (W)	ON/OFF	DALI
<b>3000 K</b>				
1126	2468	30	33.42.55.02.064	33.42.55.02.080
	4655	63	33.42.55.02.068	33.42.55.02.084
1407	3269	39	33.42.55.02.065	33.42.55.02.081
	6168	82	33.42.55.02.069	33.42.55.02.085
2250	4934	60	33.42.55.02.066	33.42.55.02.082
	9310	126	33.42.55.02.070	33.42.55.02.086
2812	6168	75	33.42.55.02.067	33.42.55.02.083
	11638	157	33.42.55.02.071	33.42.55.02.087
<b>4000 K</b>				
1126	2581	30	33.42.55.02.096	33.42.55.02.112
	4871	63	33.42.55.02.100	33.42.55.02.116
1407	3420	39	33.42.55.02.097	33.42.55.02.113
	6454	82	33.42.55.02.101	33.42.55.02.117
2250	5163	60	33.42.55.02.098	33.42.55.02.114
	9742	126	33.42.55.02.102	33.42.55.02.118
2812	6453	75	33.42.55.02.099	33.42.55.02.115
	12178	157	33.42.55.02.103	33.42.55.02.119

**MATT ANODIZED FINISHING**

c (mm)	Output (lm)	System (W)	ON/OFF	DALI
<b>3000 K</b>				
1126	2468	30	33.42.55.02.072	33.42.55.02.088
	4655	63	33.42.55.02.076	33.42.55.02.092
1407	3269	39	33.42.55.02.073	33.42.55.02.089
	6168	82	33.42.55.02.077	33.42.55.02.093
2250	4934	60	33.42.55.02.074	33.42.55.02.090
	9310	126	33.42.55.02.078	33.42.55.02.094
2812	6168	75	33.42.55.02.075	33.42.55.02.091
	11638	157	33.42.55.02.079	33.42.55.02.095
<b>4000 K</b>				
1126	2581	30	33.42.55.02.104	33.42.55.02.120
	4871	63	33.42.55.02.108	33.42.55.02.124
1407	3420	39	33.42.55.02.105	33.42.55.02.121
	6454	82	33.42.55.02.109	33.42.55.02.125
2250	5163	60	33.42.55.02.106	33.42.55.02.122
	9742	126	33.42.55.02.110	33.42.55.02.126
2812	6453	75	33.42.55.02.107	33.42.55.02.123
	12178	157	33.42.55.02.111	33.42.55.02.127

# WELINE DIRECT & INDIRECT LIGHT SUSPENDED

## COMPONENTS



### END CAP (1pc)

	<b>COD</b>
Matt White	35.42.55.02.000
Matt Anodized Similar Painting	35.42.55.02.001



### SURFACE CEILING CUP (1pc)

MATT WHITE	DIMENSION	1 m	3 m	5 m
ON/OFF	Ø62x36 mm	35.42.001.01.80	35.42.001.01.88	35.42.001.01.96
ON/OFF + EM	Ø62x36 mm	35.42.001.01.81	35.42.001.01.89	35.42.001.01.97
DALI	Ø62x36 mm	35.42.001.01.82	35.42.001.01.90	35.42.001.01.98
DALI + EM	Ø103x36 mm	35.42.001.01.83	35.42.001.01.91	35.42.001.01.99



### RECESSED CEILING CUP (1pc)

MATT WHITE	DIMENSION	1 m	3 m	5 m
ON/OFF	Ø80 mm	35.42.001.01.84	35.42.001.01.92	35.42.002.01.00
ON/OFF + EM	Ø80 mm	35.42.001.01.85	35.42.001.01.93	35.42.002.01.01
DALI	Ø80 mm	35.42.001.01.86	35.42.001.01.94	35.42.002.01.02
DALI + EM	Ø80 mm	35.42.001.01.87	35.42.001.01.95	35.42.002.01.03



### SUSPENSION SYSTEM (2pcs)

TYPE	1 m	3 m	5 m
Matt White + Stainless Steel Cable	35.42.014.08.27	35.42.025.08.89	35.42.027.08.46



### LINEAR COUPLER (1pc)

	<b>COD</b>
Coupler	35.42.55.00.005

## OPTIONS



### EMERGENCY (EM) - SELF-TEST INTEGRATED

ON/OFF	<b>COD</b>
EM 1H 3W	35.00.003.01.23*
EM 3H 3W	35.00.003.01.24*
DALI	<b>COD</b>
EM 1H 5,4W DALI	35.00.003.01.54*
EM 3H 5,4W DALI	35.00.004.01.55*

\* Applies to lengths equal to or greater than 1407 mm.  
> On request – External Emergency. Box dimensions: 45x120x360 mm.

# WELINE SURFACE

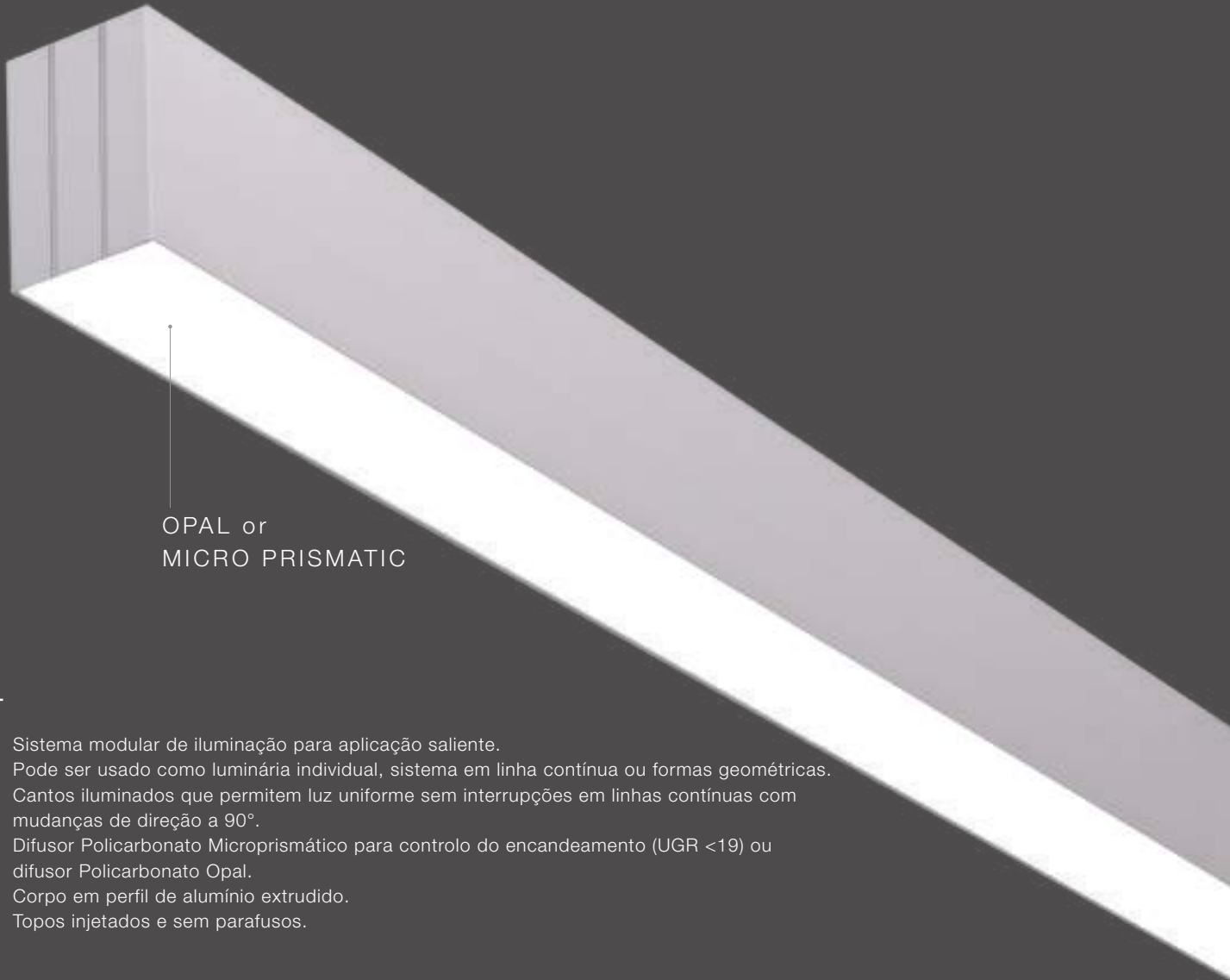

OPAL or  
MICRO PRISMATIC

## PT

- > Sistema modular de iluminação para aplicação saliente.
- > Pode ser usado como luminária individual, sistema em linha contínua ou formas geométricas.
- > Cantos iluminados que permitem luz uniforme sem interrupções em linhas contínuas com mudanças de direção a 90°.
- > Difusor Policarbonato Microprismático para controlo do encandeamento (UGR <19) ou difusor Policarbonato Opal.
- > Corpo em perfil de alumínio extrudido.
- > Topos injetados e sem parafusos.

## ES

- > Sistema modular de iluminación para instalación en superficie.
- > Se puede usar como luminaria individual, sistema en línea continua o formas geométricas.
- > Esquinas iluminadas aseguran luz uniforme sin interrupciones en las líneas continuas con cambios de dirección de 90°.
- > Difusor Policarbonato Microprismático para control del deslumbramiento (UGR <19) o difusor Policarbonato Opal.
- > Cuerpo en perfil de aluminio extruido.
- > Tapas finales inyectadas y sin tornillos.

**QUICK INFO**

**GENERAL**

Surface  
 IP40  
 IK05  
 850°C  
 Class I  
 Ta= -20°C +35°C

**OPTIC**

Opal Polycarbonate

**LED**

Efficacy up to 172 lm/W  
 3000 K, 4000 K  
 CRI >80  
 Lifetime 72 000 H  
 L80/B10 @Tc=70°C

**ELETRICAL SYSTEM**

230V/50Hz  
 ON/OFF, DALI

**FINISHING**

RAL 9003 Matt White

**OPTIONS**

**LED**

2700 K, 5000 K, 6500 K  
 Tunable White, RGB, RGBW  
 CRI >90

**ELECTRICAL SYSTEM**

DSI, DIM 1-10V, Phase-cut

**CONTROL SYSTEM**

Bluetooth

**FINISHING**

 Other Colours

**EMERGENCY**

1 Hour, 3 Hours  
 DALI 1 Hour, 3 Hours

**SENSORS**

Motion  
 Ambient Light  
 Motion & Ambient Light

**WELINE SURFACE**

**OPAL DIFFUSER**

**MATT WHITE FINISHING**

c (mm)	Output (lm)	System (W)	ON/OFF	DALI
<b>3000 K</b>				
564	1241	13	33.42.55.10.012	33.42.55.10.072
	2480	25	33.42.55.10.018	33.42.55.10.078
845	1860	19	33.42.55.10.013	33.42.55.10.073
	3720	38	33.42.55.10.019	33.42.55.10.079
1126	2480	25	33.42.55.10.014	33.42.55.10.074
	4961	50	33.42.55.10.020	33.42.55.10.080
1407	3100	31	33.42.55.10.015	33.42.55.10.075
	6201	63	33.42.55.10.021	33.42.55.10.081
2250	4959	50	33.42.55.10.016	33.42.55.10.076
	9921	101	33.42.55.10.022	33.42.55.10.082
2812	6200	63	33.42.55.10.017	33.42.55.10.077
	12401	126	33.42.55.10.023	33.42.55.10.083
Corner 600x600	2480	25	33.42.55.10.502	33.42.55.10.512
	4961	50	33.42.55.10.503	33.42.55.10.513
<b>4000 K</b>				
564	1298	13	33.42.55.10.132	33.42.55.10.192
	2595	25	33.42.55.10.138	33.42.55.10.198
845	1947	19	33.42.55.10.133	33.42.55.10.193
	3893	38	33.42.55.10.139	33.42.55.10.199
1126	2595	25	33.42.55.10.134	33.42.55.10.194
	5190	50	33.42.55.10.140	33.42.55.10.200
1407	3244	31	33.42.55.10.135	33.42.55.10.195
	6488	63	33.42.55.10.141	33.42.55.10.201
2250	5190	50	33.42.55.10.136	33.42.55.10.196
	10381	101	33.42.55.10.142	33.42.55.10.202
2812	6489	63	33.42.55.10.137	33.42.55.10.197
	12976	126	33.42.55.10.143	33.42.55.10.203
Corner 600x600	2595	25	33.42.55.10.522	33.42.55.10.532
	5190	50	33.42.55.10.523	33.42.55.10.533

> Fluorescent lamp versions also available – product data at [www.climarlighting.com](http://www.climarlighting.com) – or by direct request to the factory.

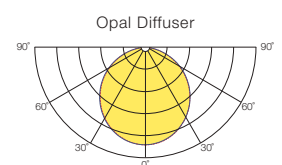
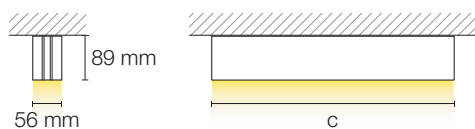

**QUICK INFO**

**GENERAL**

Surface  
 IP40  
 IK05  
 850°C  
 Class I  
 Ta= -20°C +35°C

**OPTIC**

Opal Polycarbonate

**LED**

Efficacy up to 172 lm/W  
 3000 K, 4000 K  
 CRI >80  
 Lifetime 72 000 H  
 L80/B10 @Tc=70°C

**ELETRICAL SYSTEM**

230V/50Hz  
 ON/OFF, DALI

**FINISHING**

Matt Anodized

**OPTIONS**

**LED**

2700 K, 5000 K, 6500 K  
 Tunable White, RGB, RGBW  
 CRI >90

**ELECTRICAL SYSTEM**

DSI, DIM 1-10V, Phase-cut

**CONTROL SYSTEM**

Bluetooth

**FINISHING**

 Other Colours

**EMERGENCY**

1 Hour, 3 Hours  
 DALI 1 Hour, 3 Hours

**SENSORS**

Motion  
 Ambient Light  
 Motion & Ambient Light

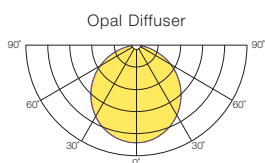

**WELINE SURFACE**

**OPAL DIFFUSER**

**MATT ANODIZED FINISHING**

c (mm)	Output (lm)	System (W)	ON/OFF	DALI
<b>3000 K</b>				
564	1241	13	33.42.55.10.000	33.42.55.10.060
	2480	25	33.42.55.10.006	33.42.55.10.066
845	1860	19	33.42.55.10.001	33.42.55.10.061
	3720	38	33.42.55.10.007	33.42.55.10.067
1126	2480	25	33.42.55.10.002	33.42.55.10.062
	4961	50	33.42.55.10.008	33.42.55.10.068
1407	3100	31	33.42.55.10.003	33.42.55.10.063
	6201	63	33.42.55.10.009	33.42.55.10.069
2250	4959	50	33.42.55.10.004	33.42.55.10.064
	9921	101	33.42.55.10.010	33.42.55.10.070
2812	6200	63	33.42.55.10.005	33.42.55.10.065
	12401	126	33.42.55.10.011	33.42.55.10.071
Corner 600x600	2480	25	33.42.55.10.500	33.42.55.10.510
	4961	50	33.42.55.10.501	33.42.55.10.511
<b>4000 K</b>				
564	1298	13	33.42.55.10.120	33.42.55.10.180
	2595	25	33.42.55.10.126	33.42.55.10.186
845	1947	19	33.42.55.10.121	33.42.55.10.181
	3893	38	33.42.55.10.127	33.42.55.10.187
1126	2595	25	33.42.55.10.122	33.42.55.10.182
	5190	50	33.42.55.10.128	33.42.55.10.188
1407	3244	31	33.42.55.10.123	33.42.55.10.183
	6488	63	33.42.55.10.129	33.42.55.10.189
2250	5190	50	33.42.55.10.124	33.42.55.10.184
	10381	101	33.42.55.10.130	33.42.55.10.190
2812	6489	63	33.42.55.10.125	33.42.55.10.185
	12976	126	33.42.55.10.131	33.42.55.10.191
Corner 600x600	2595	25	33.42.55.10.520	33.42.55.10.530
	5190	50	33.42.55.10.521	33.42.55.10.531

> Fluorescent lamp versions also available – product data at [www.climarlighting.com](http://www.climarlighting.com) – or by direct request to the factory.

**DESCRIPTION**

- 1 > DRIVER
- 2 > LED BOARD
- 3 > LED COVER
- 4 > REFLECTOR
- 5 > DIFFUSER



**QUICK INFO**

**GENERAL**

Surface  
 IP40  
 IK05  
 850°C  
 Class I  
 Ta= -20°C +35°C

**OPTIC**

Micro Prismatic Polycarbonate  
 UGR <19

**LED**

Efficacy up to 182 lm/W  
 3000 K, 4000 K  
 CRI >80  
 Lifetime 72 000 H  
 L80/B10 @Tc=70°C

**ELETRICAL SYSTEM**

230V/50Hz  
 ON/OFF, DALI

**FINISHING**

RAL 9003 Matt White

**OPTIONS**

**LED**

2700 K, 5000 K, 6500 K  
 Tunable White, RGB, RGBW  
 CRI >90

**ELECTRICAL SYSTEM**

DSI, DIM 1-10V, Phase-cut

**CONTROL SYSTEM**

Bluetooth

**FINISHING**

 Other Colours

**EMERGENCY**

1 Hour, 3 Hours  
 DALI 1 Hour, 3 Hours

**SENSORS**

Motion  
 Ambient Light  
 Motion & Ambient Light

**WELINE SURFACE**

**MICRO PRISMATIC DIFFUSER - UGR <19**

**MATT WHITE FINISHING**

c (mm)	Output (lm)	System (W)	ON/OFF	DALI
<b>3000 K</b>				
	506	7	33.42.55.10.054	33.42.55.10.114
564	816	13	33.42.55.10.042	33.42.55.10.102
	1630	25	33.42.55.10.048	33.42.55.10.108
845	759	11	33.42.55.10.055	33.42.55.10.115
	1223	19	33.42.55.10.043	33.42.55.10.103
1126	2446	38	33.42.55.10.049	33.42.55.10.109
	1012	15	33.42.55.10.056	33.42.55.10.116
1407	1630	25	33.42.55.10.044	33.42.55.10.104
	3262	50	33.42.55.10.050	33.42.55.10.110
2250	1265	18	33.42.55.10.057	33.42.55.10.117
	2038	31	33.42.55.10.045	33.42.55.10.105
2812	4077	63	33.42.55.10.051	33.42.55.10.111
	2023	29	33.42.55.10.058	33.42.55.10.118
Corner 600x600	3261	50	33.42.55.10.046	33.42.55.10.106
	6523	101	33.42.55.10.052	33.42.55.10.112
Corner 600x600	2529	37	33.42.55.10.059	33.42.55.10.119
	4076	63	33.42.55.10.047	33.42.55.10.107
Corner 600x600	8154	126	33.42.55.10.053	33.42.55.10.113
	1012	15	33.42.55.10.507	33.42.55.10.517
Corner 600x600	1630	25	33.42.55.10.508	33.42.55.10.518
	3262	50	33.42.55.10.509	33.42.55.10.519
<b>4000 K</b>				
	529	7	33.42.55.10.174	33.42.55.10.234
564	854	13	33.42.55.10.162	33.42.55.10.222
	1706	25	33.42.55.10.168	33.42.55.10.228
845	794	11	33.42.55.10.175	33.42.55.10.235
	1280	19	33.42.55.10.163	33.42.55.10.223
1126	2559	38	33.42.55.10.169	33.42.55.10.229
	1058	15	33.42.55.10.176	33.42.55.10.236
1407	1706	25	33.42.55.10.164	33.42.55.10.224
	3413	50	33.42.55.10.170	33.42.55.10.230
2250	1323	18	33.42.55.10.177	33.42.55.10.237
	2133	31	33.42.55.10.165	33.42.55.10.225
2812	4266	63	33.42.55.10.171	33.42.55.10.231
	2117	29	33.42.55.10.178	33.42.55.10.238
Corner 600x600	3413	50	33.42.55.10.166	33.42.55.10.226
	6825	101	33.42.55.10.172	33.42.55.10.232
Corner 600x600	2646	37	33.42.55.10.179	33.42.55.10.239
	4266	63	33.42.55.10.167	33.42.55.10.227
Corner 600x600	8532	126	33.42.55.10.173	33.42.55.10.233
	1058	15	33.42.55.10.527	33.42.55.10.537
Corner 600x600	1706	25	33.42.55.10.528	33.42.55.10.538
	3413	50	33.42.55.10.529	33.42.55.10.539

Micro Prismatic Diffuser - UGR<19

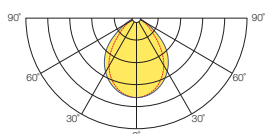

**QUICK INFO**

**GENERAL**

Surface  
 IP40  
 IK05  
 850°C  
 Class I  
 Ta= -20°C +35°C

**OPTIC**

Micro Prismatic Polycarbonate  
 UGR <19

**LED**

Efficacy up to 182 lm/W  
 3000 K, 4000 K  
 CRI >80  
 Lifetime 72 000 H  
 L80/B10 @Tc=70°C

**ELETRICAL SYSTEM**

230V/50Hz  
 ON/OFF, DALI

**FINISHING**

Matt Anodized

**OPTIONS**

**LED**

2700 K, 5000 K, 6500 K  
 Tunable White, RGB, RGBW  
 CRI >90

**ELECTRICAL SYSTEM**

DSI, DIM 1-10V, Phase-cut

**CONTROL SYSTEM**

Bluetooth

**FINISHING**

 Other Colours

**EMERGENCY**

1 Hour, 3 Hours  
 DALI 1 Hour, 3 Hours

**SENSORS**

Motion  
 Ambient Light  
 Motion & Ambient Light

**WELINE SURFACE**

**MICRO PRISMATIC DIFFUSER - UGR <19**

**MATT ANODIZED FINISHING**

c (mm)	Output (lm)	System (W)	ON/OFF	DALI
<b>3000 K</b>				
	506	7	33.42.55.10.036	33.42.55.10.096
564	816	13	33.42.55.10.024	33.42.55.10.084
	1630	25	33.42.55.10.030	33.42.55.10.090
845	759	11	33.42.55.10.037	33.42.55.10.097
	1223	19	33.42.55.10.025	33.42.55.10.085
1126	2446	38	33.42.55.10.031	33.42.55.10.091
	1012	15	33.42.55.10.038	33.42.55.10.098
1407	1630	25	33.42.55.10.026	33.42.55.10.086
	3262	50	33.42.55.10.032	33.42.55.10.092
2250	1265	18	33.42.55.10.039	33.42.55.10.099
	2038	31	33.42.55.10.027	33.42.55.10.087
2812	4077	63	33.42.55.10.033	33.42.55.10.093
	2023	29	33.42.55.10.040	33.42.55.10.100
Corner 600x600	3261	50	33.42.55.10.028	33.42.55.10.088
	6523	101	33.42.55.10.034	33.42.55.10.094
Corner 600x600	2529	37	33.42.55.10.041	33.42.55.10.101
	4076	63	33.42.55.10.029	33.42.55.10.089
Corner 600x600	8154	126	33.42.55.10.035	33.42.55.10.095
	1012	15	33.42.55.10.504	33.42.55.10.514
Corner 600x600	1630	25	33.42.55.10.505	33.42.55.10.515
	3262	50	33.42.55.10.506	33.42.55.10.516
<b>4000 K</b>				
	529	7	33.42.55.10.156	33.42.55.10.216
564	854	13	33.42.55.10.144	33.42.55.10.204
	1706	25	33.42.55.10.150	33.42.55.10.210
845	794	11	33.42.55.10.157	33.42.55.10.217
	1280	19	33.42.55.10.145	33.42.55.10.205
1126	2559	38	33.42.55.10.151	33.42.55.10.211
	1058	15	33.42.55.10.158	33.42.55.10.218
1407	1706	25	33.42.55.10.146	33.42.55.10.206
	3413	50	33.42.55.10.152	33.42.55.10.212
2250	1323	18	33.42.55.10.159	33.42.55.10.219
	2133	31	33.42.55.10.147	33.42.55.10.207
2812	4266	63	33.42.55.10.153	33.42.55.10.213
	2117	29	33.42.55.10.160	33.42.55.10.220
Corner 600x600	3413	50	33.42.55.10.148	33.42.55.10.208
	6825	101	33.42.55.10.154	33.42.55.10.214
Corner 600x600	2646	37	33.42.55.10.161	33.42.55.10.221
	4266	63	33.42.55.10.149	33.42.55.10.209
Corner 600x600	8532	126	33.42.55.10.155	33.42.55.10.215
	1058	15	33.42.55.10.524	33.42.55.10.534
Corner 600x600	1706	25	33.42.55.10.525	33.42.55.10.535
	3413	50	33.42.55.10.526	33.42.55.10.536

Micro Prismatic Diffuser - UGR<19

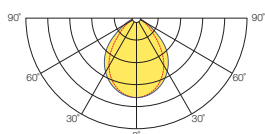



# WELINE SURFACE

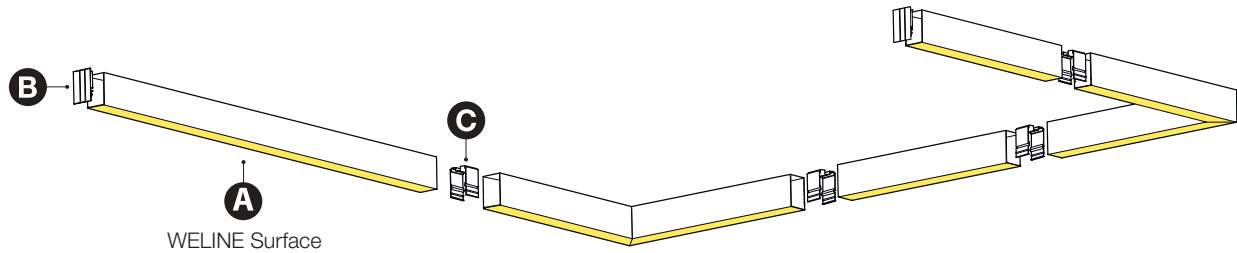

## COMPONENTS



<b>B</b> END CAP (1pc)	COD
Matt White	35.42.55.00.000
Matt Anodized Similar Painting	35.42.55.00.001



<b>C</b> LINEAR COUPLER (1pc)	COD
Coupler	35.42.55.00.005

## OPTIONS



### EMERGENCY (EM) - SELF-TEST INTEGRATED

ON/OFF	COD
EM 1H 3W	35.00.003.01.23*
EM 3H 3W	35.00.003.01.24**
DALI	COD
EM 1H 5,4W DALI	35.00.004.01.54*
EM 3H 5,4W DALI	35.00.004.01.55**

\* Applies to lengths equal to or greater than 1126 mm. \*\* Applies to lengths equal to or greater than 1407 mm.  
> On request - External Emergency. Box dimensions: 45x120x360 mm.

# WELINE IP54 SURFACE

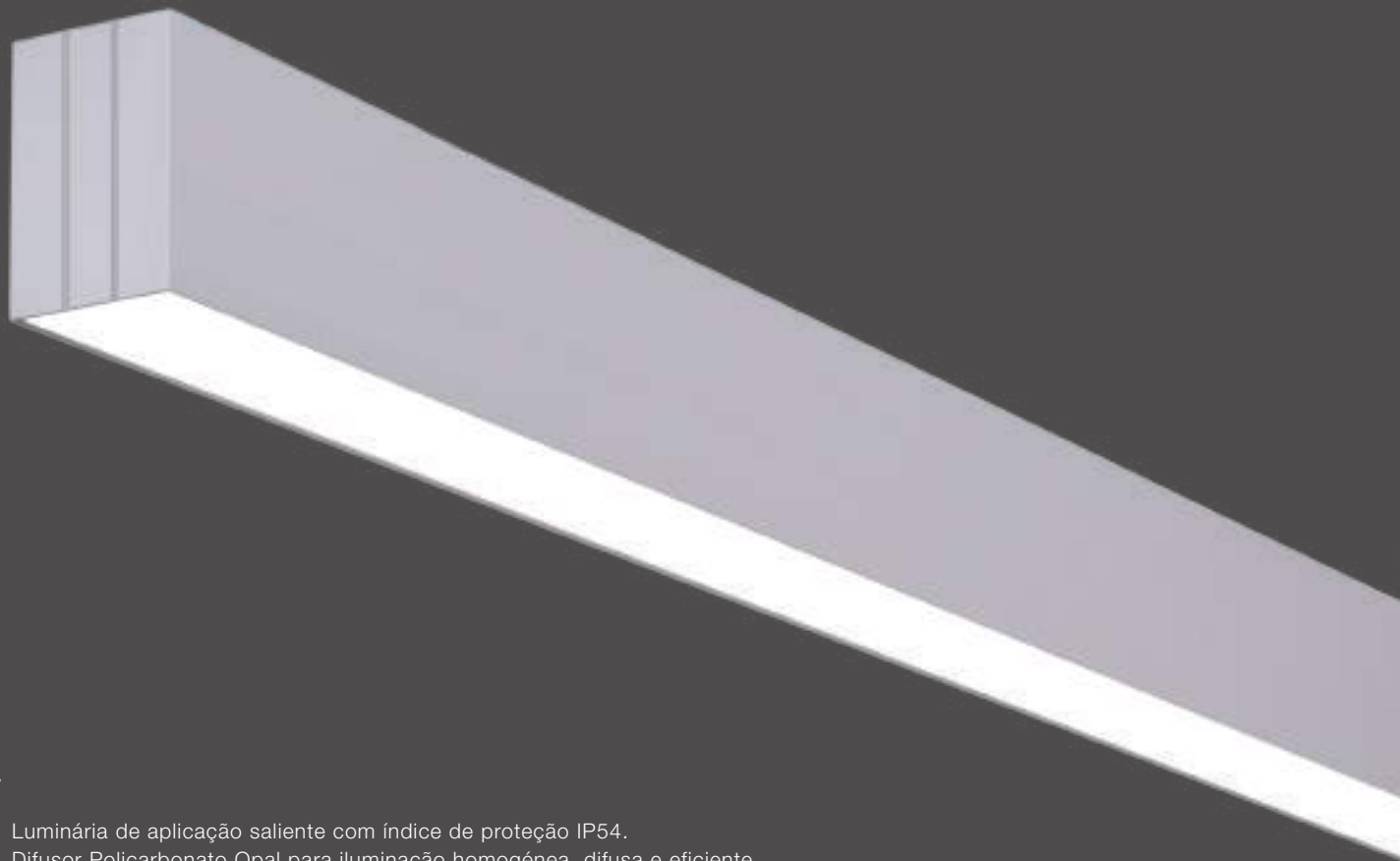

## PT

- > Luminária de aplicação saliente com índice de proteção IP54.
- > Difusor Policarbonato Opal para iluminação homogénea, difusa e eficiente.
- > Corpo em perfil de alumínio extrudido.
- > Inclui topos injetados e sem parafusos.

## ES

- > Luminaria para instalación en superficie con grado de protección IP54.
- > Difusor Policarbonato Opal.
- > Cuerpo en perfil de aluminio extruido.
- > Incluye tapas finales inyectadas y sin tornillos.

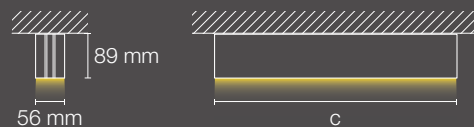

**QUICK INFO**

**GENERAL**

Surface  
IP54  
IK05  
850°C  
Class I  
Ta= -20°C +35°C

**OPTIC**

Opal Polycarbonate

**LED**

Efficacy up to 172 lm/W  
3000 K, 4000 K  
CRI >80  
Lifetime 72 000 H  
L80/B10 @Tc=70°C

**ELECTRICAL SYSTEM**

230V/50Hz  
ON/OFF, DALI

**FINISHING**

RAL 9003 Matt White

**OPTIONS**

**LED**

2700 K, 5000 K, 6500 K  
Tunable White, RGB, RGBW  
CRI >90

**ELECTRICAL SYSTEM**

DSI, DIM 1-10V, Phase-cut

**CONTROL SYSTEM**

Bluetooth

**FINISHING**

 Other Colours

**EMERGENCY**

1 Hour, 3 Hours  
DALI 1 Hour, 3 Hours

**SENSORS**

Motion  
Ambient Light  
Motion & Ambient Light

**WELINE IP54 SURFACE**

**OPAL DIFFUSER**

**MATT WHITE FINISHING**

c (mm)	Output (lm)	System (W)	ON/OFF	DALI
<b>3000 K</b>				
570	979	13	33.42.55.11.012	33.42.55.11.060
	1957	25	33.42.55.11.018	33.42.55.11.066
850	1468	19	33.42.55.11.013	33.42.55.11.061
	2936	38	33.42.55.11.019	33.42.55.11.067
1131	1957	25	33.42.55.11.014	33.42.55.11.062
	3915	50	33.42.55.11.020	33.42.55.11.068
1412	2446	31	33.42.55.11.015	33.42.55.11.063
	4893	63	33.42.55.11.021	33.42.55.11.069
2252	3914	50	33.42.55.11.016	33.42.55.11.064
	7830	101	33.42.55.11.022	33.42.55.11.070
2817	4893	63	33.42.55.11.017	33.42.55.11.065
	9787	126	33.42.55.11.023	33.42.55.11.071
<b>4000 K</b>				
570	1025	13	33.42.55.11.108	33.42.55.11.156
	2048	25	33.42.55.11.114	33.42.55.11.162
850	1536	19	33.42.55.11.109	33.42.55.11.157
	3072	38	33.42.55.11.115	33.42.55.11.163
1131	2048	25	33.42.55.11.110	33.42.55.11.158
	4096	50	33.42.55.11.116	33.42.55.11.164
1412	2560	31	33.42.55.11.111	33.42.55.11.159
	5120	63	33.42.55.11.117	33.42.55.11.165
2252	4096	50	33.42.55.11.112	33.42.55.11.160
	8192	101	33.42.55.11.118	33.42.55.11.166
2817	5121	63	33.42.55.11.113	33.42.55.11.161
	10240	126	33.42.55.11.119	33.42.55.11.167

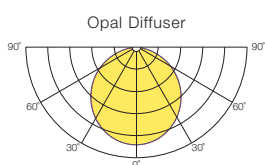

**DESCRIPTION**

- 1 > DRIVER
- 2 > REFLECTOR + LED BOARD
- 3 > DIFFUSER



**QUICK INFO**

**GENERAL**

Surface  
IP54  
IK05  
850°C  
Class I  
Ta= -20°C +35°C

**OPTIC**

Opal Polycarbonate

**LED**

Efficacy up to 172 lm/W  
3000 K, 4000 K  
CRI >80  
Lifetime 72 000 H  
L80/B10 @Tc=70°C

**ELECTRICAL SYSTEM**

230V/50Hz  
ON/OFF, DALI

**FINISHING**

Matt Anodized

**OPTIONS**

**LED**

2700 K, 5000 K, 6500 K  
Tunable White, RGB, RGBW  
CRI >90

**ELECTRICAL SYSTEM**

DSI, DIM 1-10V, Phase-cut

**CONTROL SYSTEM**

Bluetooth

**FINISHING**

RAL 9005 Matt Black  
 Other Colours

**EMERGENCY**

1 Hour, 3 Hours  
DALI 1 Hour, 3 Hours

**SENSORS**

Motion  
Ambient Light  
Motion & Ambient Light

**WELINE IP54 SURFACE**

**OPAL DIFFUSER**

**MATT ANODIZED FINISHING**

c (mm)	Output (lm)	System (W)	ON/OFF	DALI
<b>3000 K</b>				
570	979	13	33.42.55.11.000	33.42.55.11.048
	1957	25	33.42.55.11.006	33.42.55.11.054
850	1468	19	33.42.55.11.001	33.42.55.11.049
	2936	38	33.42.55.11.007	33.42.55.11.055
1131	1957	25	33.42.55.11.002	33.42.55.11.050
	3915	50	33.42.55.11.008	33.42.55.11.056
1412	2446	31	33.42.55.11.003	33.42.55.11.051
	4893	63	33.42.55.11.009	33.42.55.11.057
2252	3914	50	33.42.55.11.004	33.42.55.11.052
	7830	101	33.42.55.11.010	33.42.55.11.058
2817	4893	63	33.42.55.11.005	33.42.55.11.053
	9787	126	33.42.55.11.011	33.42.55.11.059
<b>4000 K</b>				
570	1025	13	33.42.55.11.096	33.42.55.11.144
	2048	25	33.42.55.11.102	33.42.55.11.150
850	1536	19	33.42.55.11.097	33.42.55.11.145
	3072	38	33.42.55.11.103	33.42.55.11.151
1131	2048	25	33.42.55.11.098	33.42.55.11.146
	4096	50	33.42.55.11.104	33.42.55.11.152
1412	2560	31	33.42.55.11.099	33.42.55.11.147
	5120	63	33.42.55.11.105	33.42.55.11.153
2252	4096	50	33.42.55.11.100	33.42.55.11.148
	8192	101	33.42.55.11.106	33.42.55.11.154
2817	5121	63	33.42.55.11.101	33.42.55.11.149
	10240	126	33.42.55.11.107	33.42.55.11.155

**OPTIONS**

**EMERGENCY (EM) - SELF-TEST INTEGRATED**

ON/OFF	COD
EM 1H 3W	35.00.003.01.23*
EM 3H 3W	35.00.003.01.24**

DALI	COD
EM 1H 5,4W DALI	35.00.004.01.54*
EM 3H 5,4W DALI	35.00.004.01.55**

\* Applies to lengths equal to or greater than 1131 mm. \*\* Applies to lengths equal to or greater than 1412 mm.  
> On request - External Emergency. Box dimensions: 45x120x360 mm.

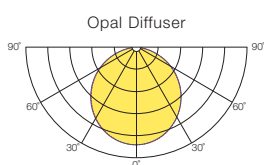

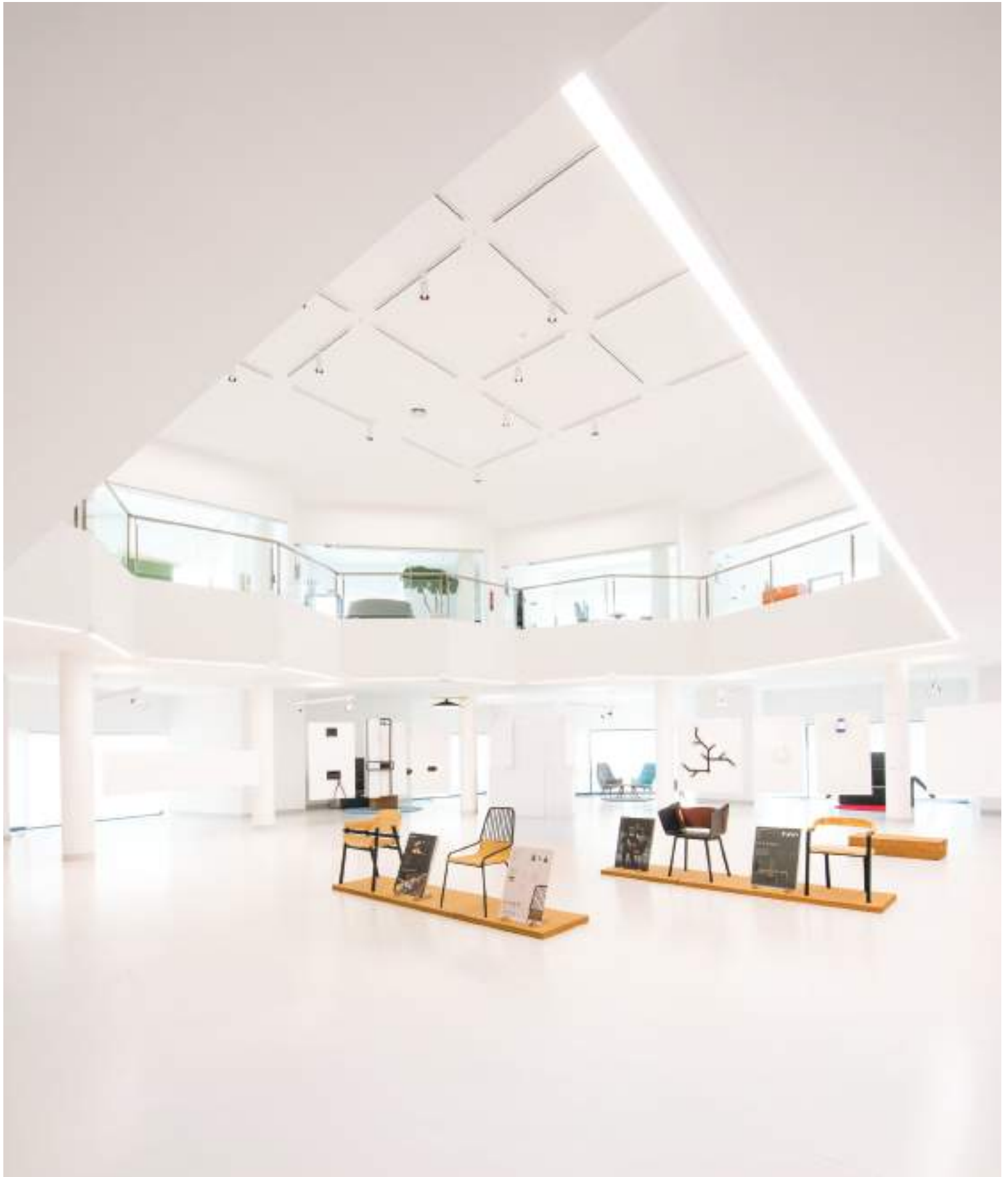

**WELINE**  
RECESSED





# WELINE RECESSED

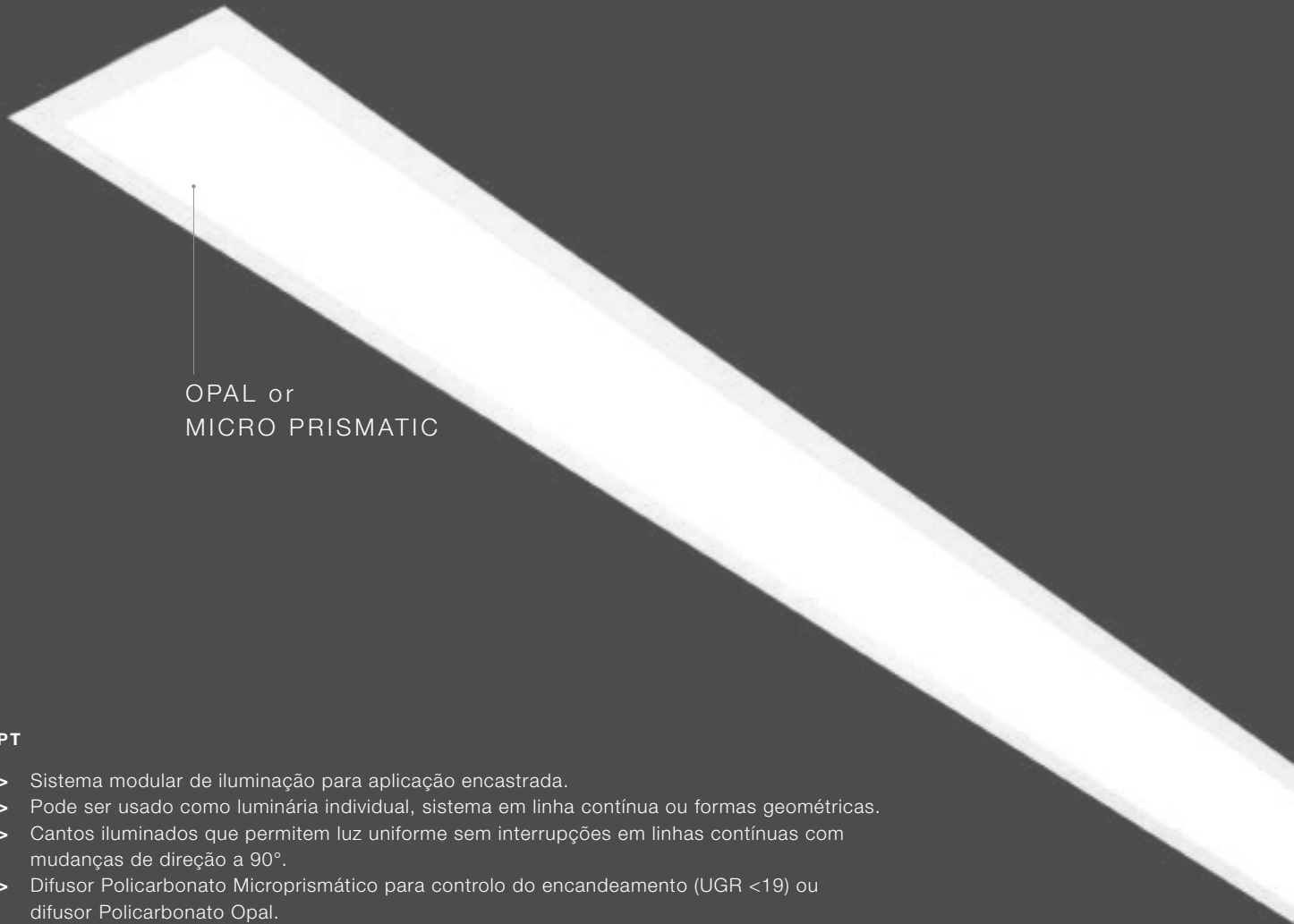

OPAL or  
MICRO PRISMATIC

## PT

- > Sistema modular de iluminação para aplicação encastrada.
- > Pode ser usado como luminária individual, sistema em linha contínua ou formas geométricas.
- > Cantos iluminados que permitem luz uniforme sem interrupções em linhas contínuas com mudanças de direção a 90°.
- > Difusor Policarbonato Microprismático para controlo do encandeamento (UGR <19) ou difusor Policarbonato Opal.
- > Corpo em perfil de alumínio extrudido.

## ES

- > Sistema modular de iluminación para instalación empotrada en el techo.
- > Se puede usar como luminaria individual, sistema en línea continua o formas geométricas.
- > Esquinas iluminadas aseguran luz uniforme sin interrupciones en las líneas continuas con cambios de dirección de 90°.
- > Difusor Policarbonato Microprismático para control del deslumbramiento (UGR <19) o difusor Policarbonato Opal.
- > Cuerpo en perfil de aluminio extruido.



**QUICK INFO**

**GENERAL**

Recessed  
 IP43 (Optic)  
 IP20  
 IK05  
 850°C  
 Class I  
 Ta= -20°C +35°C

**OPTIC**

Opal Polycarbonate

**LED**

Efficacy up to 172 lm/W  
 3000 K, 4000 K  
 CRI >80  
 Lifetime 72 000 H  
 L80/B10 @Tc=70°C

**ELECTRICAL SYSTEM**

230V/50Hz  
 ON/OFF, DALI

**FINISHING**

RAL 9003 Matt White

**OPTIONS**

**GENERAL** (Individual Luminaire)

IP44 (Optic)  
 Class II

**LED**

2700 K, 5000 K, 6500 K  
 Tunable White, RGB, RGBW  
 CRI >90

**ELECTRICAL SYSTEM**

DSI, DIM 1-10V, Phase-cut

**CONTROL SYSTEM**

Bluetooth

**FINISHING**

Other Colours

**EMERGENCY**

1 Hour, 3 Hours  
 DALI 1 Hour, 3 Hours

**SENSORS**

Motion  
 Ambient Light  
 Motion & Ambient Light

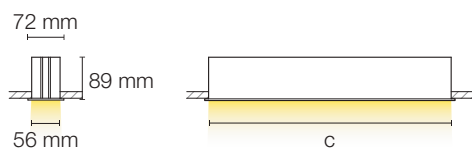

**WELINE RECESSED**

**OPAL DIFFUSER**

**MATT WHITE FINISHING**

c (mm)	Output (lm)	System (W)	ON/OFF	DALI
<b>3000 K</b>				
564	1241	13	33.42.55.20.012	33.42.55.20.072
	2480	25	33.42.55.20.018	33.42.55.20.078
845	1860	19	33.42.55.20.013	33.42.55.20.073
	3720	38	33.42.55.20.019	33.42.55.20.079
1126	2480	25	33.42.55.20.014	33.42.55.20.074
	4961	50	33.42.55.20.020	33.42.55.20.080
1407	3100	31	33.42.55.20.015	33.42.55.20.075
	6201	63	33.42.55.20.021	33.42.55.20.081
2250	4959	50	33.42.55.20.016	33.42.55.20.076
	9921	101	33.42.55.20.022	33.42.55.20.082
2812	6200	63	33.42.55.20.017	33.42.55.20.077
	12401	126	33.42.55.20.023	33.42.55.20.083
Corner 610x610	2480	25	33.42.55.20.502	33.42.55.20.512
	4961	50	33.42.55.20.503	33.42.55.20.513
<b>4000 K</b>				
564	1298	13	33.42.55.20.132	33.42.55.20.192
	2595	25	33.42.55.20.138	33.42.55.20.198
845	1947	19	33.42.55.20.133	33.42.55.20.193
	3893	38	33.42.55.20.139	33.42.55.20.199
1126	2595	25	33.42.55.20.134	33.42.55.20.194
	5190	50	33.42.55.20.140	33.42.55.20.200
1407	3244	31	33.42.55.20.135	33.42.55.20.195
	6488	63	33.42.55.20.141	33.42.55.20.201
2250	5190	50	33.42.55.20.136	33.42.55.20.196
	10381	101	33.42.55.20.142	33.42.55.20.202
2812	6489	63	33.42.55.20.137	33.42.55.20.197
	12976	126	33.42.55.20.143	33.42.55.20.203
Corner 610x610	2595	25	33.42.55.20.522	33.42.55.20.532
	5190	50	33.42.55.20.523	33.42.55.20.533

> Fluorescent lamp versions also available – product data at [www.climarlighting.com](http://www.climarlighting.com) – or by direct request to the factory.

**ON REQUEST (INDIVIDUAL LUMINAIRE)**

- > IP44 (OPTIC);
- > CLASS II.

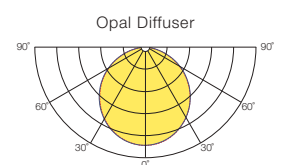

**QUICK INFO**

**GENERAL**

Recessed  
 IP43 (Optic)  
 IP20  
 IK05  
 850°C  
 Class I  
 Ta= -20°C +35°C

**OPTIC**

Opal Polycarbonate

**LED**

Efficacy up to 172 lm/W  
 3000 K, 4000 K  
 CRI >80  
 Lifetime 72 000 H  
 L80/B10 @Tc=70°C

**ELECTRICAL SYSTEM**

230V/50Hz  
 ON/OFF, DALI

**FINISHING**

Matt Anodized

**OPTIONS**

**GENERAL** (Individual Luminaire)

IP44 (Optic)  
 Class II

**LED**

2700 K, 5000 K, 6500 K  
 Tunable White, RGB, RGBW  
 CRI >90

**ELECTRICAL SYSTEM**

DSI, DIM 1-10V, Phase-cut

**CONTROL SYSTEM**

Bluetooth

**FINISHING**

Other Colours

**EMERGENCY**

1 Hour, 3 Hours  
 DALI 1 Hour, 3 Hours

**SENSORS**

Motion  
 Ambient Light  
 Motion & Ambient Light

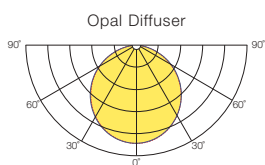

**WELINE RECESSED**

**OPAL DIFFUSER**

**MATT ANODIZED FINISHING**

c (mm)	Output (lm)	System (W)	ON/OFF	DALI
<b>3000 K</b>				
564	1241	13	33.42.55.20.000	33.42.55.20.060
	2480	25	33.42.55.20.006	33.42.55.20.066
845	1860	19	33.42.55.20.001	33.42.55.20.061
	3720	38	33.42.55.20.007	33.42.55.20.067
1126	2480	25	33.42.55.20.002	33.42.55.20.062
	4961	50	33.42.55.20.008	33.42.55.20.068
1407	3100	31	33.42.55.20.003	33.42.55.20.063
	6201	63	33.42.55.20.009	33.42.55.20.069
2250	4959	50	33.42.55.20.004	33.42.55.20.064
	9921	101	33.42.55.20.010	33.42.55.20.070
2812	6200	63	33.42.55.20.005	33.42.55.20.065
	12401	126	33.42.55.20.011	33.42.55.20.071
Corner 610x610	2480	25	33.42.55.20.500	33.42.55.20.510
	4961	50	33.42.55.20.501	33.42.55.20.511
<b>4000 K</b>				
564	1298	13	33.42.55.20.120	33.42.55.20.180
	2595	25	33.42.55.20.126	33.42.55.20.186
845	1947	19	33.42.55.20.121	33.42.55.20.181
	3893	38	33.42.55.20.127	33.42.55.20.187
1126	2595	25	33.42.55.20.122	33.42.55.20.182
	5190	50	33.42.55.20.128	33.42.55.20.188
1407	3244	31	33.42.55.20.123	33.42.55.20.183
	6488	63	33.42.55.20.129	33.42.55.20.189
2250	5190	50	33.42.55.20.124	33.42.55.20.184
	10381	101	33.42.55.20.130	33.42.55.20.190
2812	6489	63	33.42.55.20.125	33.42.55.20.185
	12976	126	33.42.55.20.131	33.42.55.20.191
Corner 610x610	2595	25	33.42.55.20.520	33.42.55.20.530
	5190	50	33.42.55.20.521	33.42.55.20.531

> Fluorescent lamp versions also available – product data at [www.climarlighting.com](http://www.climarlighting.com) – or by direct request to the factory.

**DESCRIPTION**

- 1 > DRIVER
- 2 > LED BOARD
- 3 > LED COVER
- 4 > REFLECTOR
- 5 > DIFFUSER



**QUICK INFO**

**GENERAL**

Recessed  
 IP43 (Optic)  
 IP20  
 IK05  
 850°C  
 Class I  
 Ta= -20°C +35°C

**OPTIC**

Micro Prismatic Polycarbonate  
 UGR <19

**LED**

Efficacy up to 182 lm/W  
 3000 K, 4000 K  
 CRI >80  
 Lifetime 72 000 H  
 L80/B10 @Tc=70°C

**ELETRICAL SYSTEM**

230V/50Hz  
 ON/OFF, DALI

**FINISHING**

RAL 9003 Matt White

**OPTIONS**

**GENERAL** (Individual Luminaire)

IP44 (Optic)  
 Class II

**LED**

2700 K, 5000 K, 6500 K  
 Tunable White, RGB, RGBW  
 CRI >90

**ELECTRICAL SYSTEM**

DSI, DIM 1-10V, Phase-cut

**CONTROL SYSTEM**

Bluetooth

**FINISHING**

 Other Colours

**EMERGENCY**

1 Hour, 3 Hours  
 DALI 1 Hour, 3 Hours

**SENSORS**

Motion  
 Ambient Light  
 Motion & Ambient Light

Micro Prismatic Diffuser - UGR<19

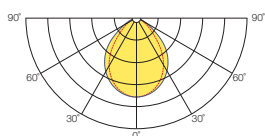

**WELINE RECESSED**

**MICRO PRISMATIC DIFFUSER - UGR <19**

**MATT WHITE FINISHING**

c (mm)	Output (lm)	System (W)	ON/OFF	DALI
<b>3000 K</b>				
	506	7	33.42.55.20.054	33.42.55.20.114
564	816	13	33.42.55.20.042	33.42.55.20.102
	1630	25	33.42.55.20.048	33.42.55.20.108
845	759	11	33.42.55.20.055	33.42.55.20.115
	1223	19	33.42.55.20.043	33.42.55.20.103
1126	2446	38	33.42.55.20.049	33.42.55.20.109
	1012	15	33.42.55.20.056	33.42.55.20.116
1407	1630	25	33.42.55.20.044	33.42.55.20.104
	3262	50	33.42.55.20.050	33.42.55.20.110
2250	1265	18	33.42.55.20.057	33.42.55.20.117
	2038	31	33.42.55.20.045	33.42.55.20.105
2812	4077	63	33.42.55.20.051	33.42.55.20.111
	2023	29	33.42.55.20.058	33.42.55.20.118
Corner 610x610	3261	50	33.42.55.20.046	33.42.55.20.106
	6523	101	33.42.55.20.052	33.42.55.20.112
Corner 610x610	2529	37	33.42.55.20.059	33.42.55.20.119
	4076	63	33.42.55.20.047	33.42.55.20.107
Corner 610x610	8154	126	33.42.55.20.053	33.42.55.20.113
	1012	15	33.42.55.20.507	33.42.55.20.517
Corner 610x610	1630	25	33.42.55.20.508	33.42.55.20.518
	3262	50	33.42.55.20.509	33.42.55.20.519
<b>4000 K</b>				
	529	7	33.42.55.20.174	33.42.55.20.234
564	854	13	33.42.55.20.162	33.42.55.20.222
	1706	25	33.42.55.20.168	33.42.55.20.228
845	794	11	33.42.55.20.175	33.42.55.20.235
	1280	19	33.42.55.20.163	33.42.55.20.223
1126	2559	38	33.42.55.20.169	33.42.55.20.229
	1058	15	33.42.55.20.176	33.42.55.20.236
1407	1706	25	33.42.55.20.164	33.42.55.20.224
	3413	50	33.42.55.20.170	33.42.55.20.230
2250	1323	18	33.42.55.20.177	33.42.55.20.237
	2133	31	33.42.55.20.165	33.42.55.20.225
2812	4266	63	33.42.55.20.171	33.42.55.20.231
	2117	29	33.42.55.20.178	33.42.55.20.238
Corner 610x610	3413	50	33.42.55.20.166	33.42.55.20.226
	6825	101	33.42.55.20.172	33.42.55.20.232
Corner 610x610	2646	37	33.42.55.20.179	33.42.55.20.239
	4266	63	33.42.55.20.167	33.42.55.20.227
Corner 610x610	8532	126	33.42.55.20.173	33.42.55.20.233
	1058	15	33.42.55.20.527	33.42.55.20.537
Corner 610x610	1706	25	33.42.55.20.528	33.42.55.20.538
	3413	50	33.42.55.20.529	33.42.55.20.539

**QUICK INFO**

**GENERAL**

Recessed  
 IP43 (Optic)  
 IP20  
 IK05  
 850°C  
 Class I  
 Ta= -20°C +35°C

**OPTIC**

Micro Prismatic Polycarbonate  
 UGR <19

**LED**

Efficacy up to 182 lm/W  
 3000 K, 4000 K  
 CRI >80  
 Lifetime 72 000 H  
 L80/B10 @Tc=70°C

**ELETRICAL SYSTEM**

230V/50Hz  
 ON/OFF, DALI

**FINISHING**

Matt Anodized

**OPTIONS**

**GENERAL** (Individual Luminaire)

IP44 (Optic)  
 Class II

**LED**

2700 K, 5000 K, 6500 K  
 Tunable White, RGB, RGBW  
 CRI >90

**ELECTRICAL SYSTEM**

DSI, DIM 1-10V, Phase-cut

**CONTROL SYSTEM**

Bluetooth

**FINISHING**

 Other Colours

**EMERGENCY**

1 Hour, 3 Hours  
 DALI 1 Hour, 3 Hours

**SENSORS**

Motion  
 Ambient Light  
 Motion & Ambient Light

Micro Prismatic Diffuser - UGR<19

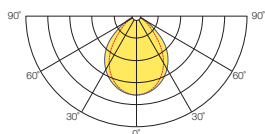

**WELINE RECESSED**

**MICRO PRISMATIC DIFFUSER - UGR <19**

**MATT ANODIZED FINISHING**

c (mm)	Output (lm)	System (W)	ON/OFF	DALI
<b>3000 K</b>				
	506	7	33.42.55.20.036	33.42.55.20.096
564	816	13	33.42.55.20.024	33.42.55.20.084
	1630	25	33.42.55.20.030	33.42.55.20.090
	759	11	33.42.55.20.037	33.42.55.20.097
845	1223	19	33.42.55.20.025	33.42.55.20.085
	2446	38	33.42.55.20.031	33.42.55.20.091
	1012	15	33.42.55.20.038	33.42.55.20.098
1126	1630	25	33.42.55.20.026	33.42.55.20.086
	3262	50	33.42.55.20.032	33.42.55.20.092
	1265	18	33.42.55.20.039	33.42.55.20.099
1407	2038	31	33.42.55.20.027	33.42.55.20.087
	4077	63	33.42.55.20.033	33.42.55.20.093
	2023	29	33.42.55.20.040	33.42.55.20.100
2250	3261	50	33.42.55.20.028	33.42.55.20.088
	6523	101	33.42.55.20.034	33.42.55.20.094
	2529	37	33.42.55.20.041	33.42.55.20.101
2812	4076	63	33.42.55.20.029	33.42.55.20.089
	8154	126	33.42.55.20.035	33.42.55.20.095
	1012	15	33.42.55.20.504	33.42.55.20.514
Corner 610x610	1630	25	33.42.55.20.505	33.42.55.20.515
	3262	50	33.42.55.20.506	33.42.55.20.516
<b>4000 K</b>				
	529	7	33.42.55.20.156	33.42.55.20.216
564	854	13	33.42.55.20.144	33.42.55.20.204
	1706	25	33.42.55.20.150	33.42.55.20.210
	794	11	33.42.55.20.157	33.42.55.20.217
845	1280	19	33.42.55.20.145	33.42.55.20.205
	2559	38	33.42.55.20.151	33.42.55.20.211
	1058	15	33.42.55.20.158	33.42.55.20.218
1126	1706	25	33.42.55.20.146	33.42.55.20.206
	3413	50	33.42.55.20.152	33.42.55.20.212
	1323	18	33.42.55.20.159	33.42.55.20.219
1407	2133	31	33.42.55.20.147	33.42.55.20.207
	4266	63	33.42.55.20.153	33.42.55.20.213
	2117	29	33.42.55.20.160	33.42.55.20.220
2250	3413	50	33.42.55.20.148	33.42.55.20.208
	6825	101	33.42.55.20.154	33.42.55.20.214
	2646	37	33.42.55.20.161	33.42.55.20.221
2812	4266	63	33.42.55.20.149	33.42.55.20.209
	8532	126	33.42.55.20.155	33.42.55.20.215
	1058	15	33.42.55.20.524	33.42.55.20.534
Corner 610x610	1706	25	33.42.55.20.525	33.42.55.20.535
	3413	50	33.42.55.20.526	33.42.55.20.536

# WELINE RECESSED

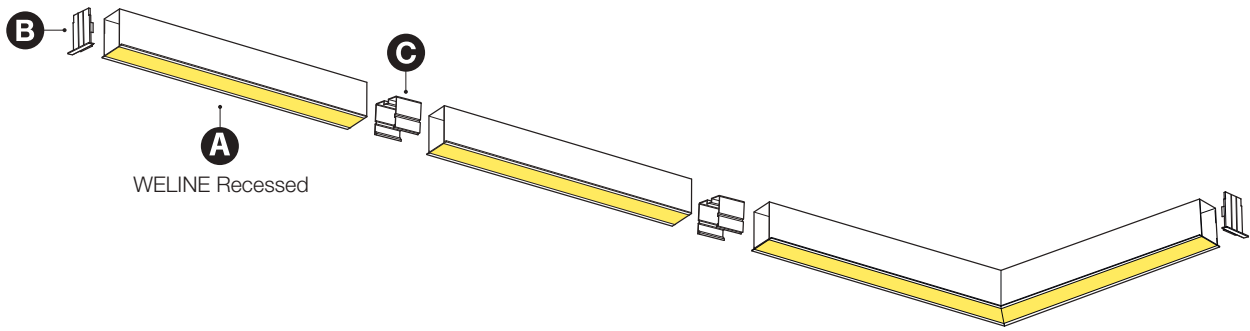

## COMPONENTS



### **B** END CAP (1pc)

	<b>COD</b>
Matt White	35.42.55.20.000
Matt Anodized Similar Painting	35.42.55.20.001



### **C** LINEAR COUPLER (1pc)

	<b>COD</b>
Coupler	35.42.55.00.005

## OPTIONS



### **EMERGENCY (EM) - SELF-TEST INTEGRATED**

<b>ON/OFF</b>	<b>COD</b>
EM 1H 3W	35.00.003.01.23*
EM 3H 3W	35.00.003.01.24**
<b>DALI</b>	<b>COD</b>
EM 1H 5,4W DALI	35.00.004.01.54*
EM 3H 5,4W DALI	35.00.004.01.55**

\* Applies to lengths equal to or greater than 1126 mm. \*\* Applies to lengths equal to or greater than 1407 mm.  
> On request - External Emergency. Box dimensions: 45x120x360 mm.

# WELINE TRIMLESS



OPAL or  
MICRO PRISMATIC

## PT

- > Sistema modular de iluminação para aplicação encastrada sem aba de remate (trimless).
- > Pode ser usado como luminária individual, sistema em linha contínua ou formas geométricas.
- > Cantos iluminados que permitem luz uniforme sem interrupções em linhas contínuas com mudanças de direção a 90°.
- > Difusor Policarbonato Microprismático para controlo do encandeamento (UGR <19) ou difusor Policarbonato Opal.
- > Corpo em perfil de alumínio extrudido.

## ES

- > Sistema modular de iluminación para instalación empotrada sin marco de remate (trimless).
- > Se puede usar como luminaria individual, sistema en línea continua o formas geométricas.
- > Esquinas iluminadas aseguran luz uniforme sin interrupciones en las líneas continuas con cambios de dirección de 90°.
- > Difusor Policarbonato Microprismático para control del deslumbramiento (UGR <19) o difusor Policarbonato Opal.
- > Cuerpo en perfil de aluminio extruido.

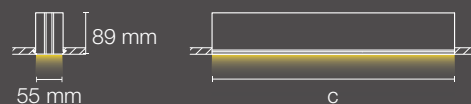

**QUICK INFO**

**GENERAL**

Trimless  
 IP43 (Optic)  
 IP20  
 IK05  
 850°C  
 Class I  
 Ta= -20°C +35°C

**OPTIC**

Opal Polycarbonate

**LED**

Efficacy up to 172 lm/W  
 3000 K, 4000 K  
 CRI >80  
 Lifetime 72 000 H  
 L80/B10 @Tc=70°C

**ELETRICAL SYSTEM**

230V/50Hz  
 ON/OFF, DALI

**FINISHING**

RAL 9003 Matt White

**OPTIONS**

**GENERAL** (Individual Luminaire)

IP44 (Optic)  
 Class II

**LED**

2700 K, 5000 K, 6500 K  
 Tunable White, RGB, RGBW  
 CRI >90

**ELECTRICAL SYSTEM**

DSI, DIM 1-10V, Phase-cut

**CONTROL SYSTEM**

Bluetooth

**EMERGENCY**

1 Hour, 3 Hours  
 DALI 1 Hour, 3 Hours

**SENSORS**

Motion  
 Ambient Light  
 Motion & Ambient Light

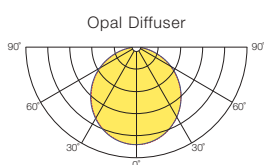

**WELINE TRIMLESS**

**OPAL DIFFUSER**

c (mm)	Output (lm)	System (W)	ON/OFF	DALI
<b>3000 K</b>				
564	1241	13	33.42.55.30.000	33.42.55.30.030
	2480	25	33.42.55.30.006	33.42.55.30.036
845	1860	19	33.42.55.30.001	33.42.55.30.031
	3720	38	33.42.55.30.007	33.42.55.30.037
1126	2480	25	33.42.55.30.002	33.42.55.30.032
	4961	50	33.42.55.30.008	33.42.55.30.038
1407	3100	31	33.42.55.30.003	33.42.55.30.033
	6201	63	33.42.55.30.009	33.42.55.30.039
2250	4959	50	33.42.55.30.004	33.42.55.30.034
	9921	101	33.42.55.30.010	33.42.55.30.040
2812	6200	63	33.42.55.30.005	33.42.55.30.035
	12401	126	33.42.55.30.011	33.42.55.30.041
Corner 607x607	2480	25	33.42.55.30.500	33.42.55.30.505
	4961	50	33.42.55.30.501	33.42.55.30.506
<b>4000 K</b>				
564	1298	13	33.42.55.30.060	33.42.55.30.090
	2595	25	33.42.55.30.066	33.42.55.30.096
845	1947	19	33.42.55.30.061	33.42.55.30.091
	3893	38	33.42.55.30.067	33.42.55.30.097
1126	2595	25	33.42.55.30.062	33.42.55.30.092
	5190	50	33.42.55.30.068	33.42.55.30.098
1407	3244	31	33.42.55.30.063	33.42.55.30.093
	6488	63	33.42.55.30.069	33.42.55.30.099
2250	5190	50	33.42.55.30.064	33.42.55.30.094
	10381	101	33.42.55.30.070	33.42.55.30.100
2812	6489	63	33.42.55.30.065	33.42.55.30.095
	12976	126	33.42.55.30.071	33.42.55.30.101
Corner 607x607	2595	25	33.42.55.30.510	33.42.55.30.515
	5190	50	33.42.55.30.511	33.42.55.30.516

**DESCRIPTION**

- 1 > DRIVER
- 2 > LED BOARD
- 3 > LED COVER
- 4 > REFLECTOR
- 5 > DIFFUSER

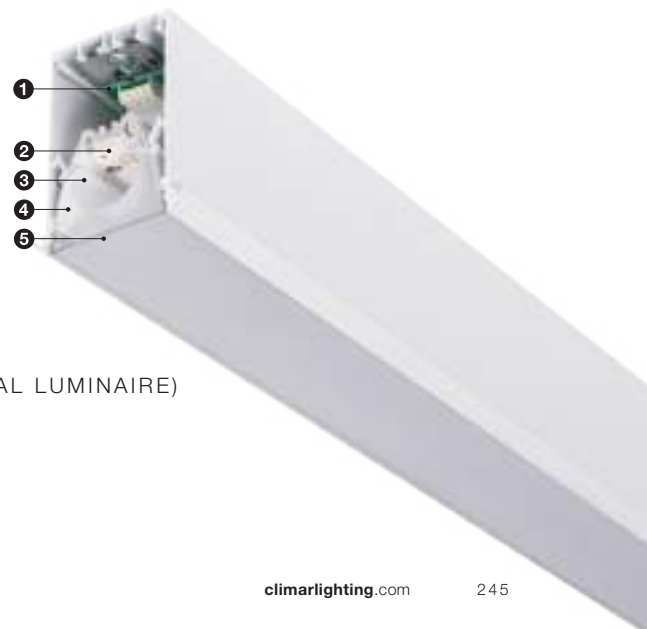

**ON REQUEST (INDIVIDUAL LUMINAIRE)**

- > IP44 (OPTIC);
- > CLASS II.

**QUICK INFO**

**GENERAL**

Trimless  
 IP43 (Optic)  
 IP20  
 IK05  
 850°C  
 Class I  
 Ta= -20°C +35°C

**OPTIC**

Micro Prismatic Polycarbonate  
 UGR <19

**LED**

Efficacy up to 182 lm/W  
 3000 K, 4000 K  
 CRI >80  
 Lifetime 72 000 H  
 L80/B10 @Tc=70°C

**ELETRICAL SYSTEM**

230V/50Hz  
 ON/OFF, DALI

**FINISHING**

RAL 9003 Matt White

**OPTIONS**

**GENERAL** (Individual Luminaire)

IP44 (Optic)  
 Class II

**LED**

2700 K, 5000 K, 6500 K  
 Tunable White, RGB, RGBW  
 CRI >90

**ELECTRICAL SYSTEM**

DSI, DIM 1-10V, Phase-cut

**CONTROL SYSTEM**

Bluetooth

**EMERGENCY**

1 Hour, 3 Hours  
 DALI 1 Hour, 3 Hours

**SENSORS**

Motion  
 Ambient Light  
 Motion & Ambient Light

**WELINE TRIMLESS**

**MICRO PRISMATIC DIFFUSER - UGR <19**

c (mm)	Output (lm)	System (W)	ON/OFF	DALI
<b>3000 K</b>				
564	506	7	33.42.55.30.024	33.42.55.30.054
	816	13	33.42.55.30.012	33.42.55.30.042
	1630	25	33.42.55.30.018	33.42.55.30.048
845	759	11	33.42.55.30.025	33.42.55.30.055
	1223	19	33.42.55.30.013	33.42.55.30.043
	2446	38	33.42.55.30.019	33.42.55.30.049
1126	1012	15	33.42.55.30.026	33.42.55.30.056
	1630	25	33.42.55.30.014	33.42.55.30.044
	3262	50	33.42.55.30.020	33.42.55.30.050
1407	1265	18	33.42.55.30.027	33.42.55.30.057
	2038	31	33.42.55.30.015	33.42.55.30.045
	4077	63	33.42.55.30.021	33.42.55.30.051
2250	2023	29	33.42.55.30.028	33.42.55.30.058
	3261	50	33.42.55.30.016	33.42.55.30.046
	6523	101	33.42.55.30.022	33.42.55.30.052
2812	2529	37	33.42.55.30.029	33.42.55.30.059
	4076	63	33.42.55.30.017	33.42.55.30.047
	8154	126	33.42.55.30.023	33.42.55.30.053
Corner 607x607	1012	15	33.42.55.30.502	33.42.55.30.507
	1630	25	33.42.55.30.503	33.42.55.30.508
	3262	50	33.42.55.30.504	33.42.55.30.509
<b>4000 K</b>				
564	529	7	33.42.55.30.084	33.42.55.30.114
	854	13	33.42.55.30.072	33.42.55.30.102
	1706	25	33.42.55.30.078	33.42.55.30.108
845	794	11	33.42.55.30.085	33.42.55.30.115
	1280	19	33.42.55.30.073	33.42.55.30.103
	2559	38	33.42.55.30.079	33.42.55.30.109
1126	1058	15	33.42.55.30.086	33.42.55.30.116
	1706	25	33.42.55.30.074	33.42.55.30.104
	3413	50	33.42.55.30.080	33.42.55.30.110
1407	1323	18	33.42.55.30.087	33.42.55.30.117
	2133	31	33.42.55.30.075	33.42.55.30.105
	4266	63	33.42.55.30.081	33.42.55.30.111
2250	2117	29	33.42.55.30.088	33.42.55.30.118
	3413	50	33.42.55.30.076	33.42.55.30.106
	6825	101	33.42.55.30.082	33.42.55.30.112
2812	2646	37	33.42.55.30.089	33.42.55.30.119
	4266	63	33.42.55.30.077	33.42.55.30.107
	8532	126	33.42.55.30.083	33.42.55.30.113
Corner 607x607	1058	15	33.42.55.30.512	33.42.55.30.517
	1706	25	33.42.55.30.513	33.42.55.30.518
	3413	50	33.42.55.30.514	33.42.55.30.519

Micro Prismatic Diffuser - UGR<19

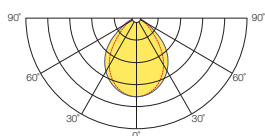



# WELINE TRIMLESS

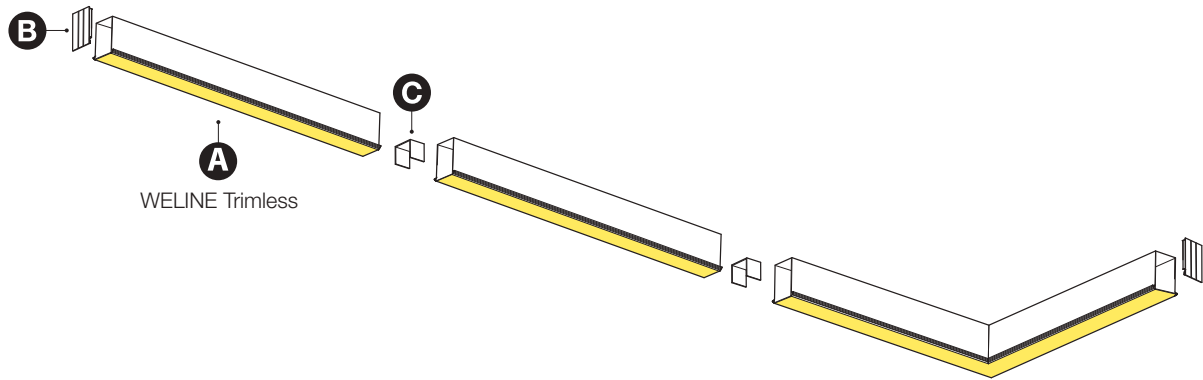

## COMPONENTS



### **B** END CAP (1pc)

Matt White

**COD**

35.42.55.00.000



### **C** LINEAR COUPLER (1pc)

Coupler

**COD**

35.42.55.00.005

## OPTIONS



### **EMERGENCY (EM) - SELF-TEST INTEGRATED**

#### **ON/OFF**

EM 1H 3W

**COD**

35.00.003.01.23\*

EM 3H 3W

35.00.003.01.24\*\*

#### **DALI**

EM 1H 5,4W DALI

**COD**

35.00.004.01.54\*

EM 3H 5,4W DALI

35.00.004.01.55\*\*

\* Applies to lengths equal to or greater than 1126 mm. \*\* Applies to lengths equal to or greater than 1407 mm.  
> On request - External Emergency. Box dimensions: 45x120x360 mm.

# WELINE EDGE TRIMLESS

## PT

- > Sistema modular de iluminação para aplicação encastrada sem aba de remate (trimless) em tetos de gesso cartonado.
- > Série de perfis para aplicação no perímetro dos tetos falsos.
- > Pode ser usado como luminária individual, sistema em linha contínua ou formas geométricas.
- > Cantos iluminados que permitem luz uniforme sem interrupções em linhas contínuas com mudanças de direção a 90°.
- > Difusor Policarbonato Opal para iluminação homogénea, difusa e eficiente.
- > Corpo em perfil de alumínio extrudido.

## ES

- > Sistema modular de iluminación para instalación empotrada sin marco de remate (trimless) en techos de placas de yeso.
- > Serie de perfiles para aplicación en el perímetro de los falsos techos.
- > Se puede usar como luminaria individual, sistema en línea continua o formas geométricas.
- > Esquinas iluminadas aseguran luz uniforme sin interrupciones en las líneas continuas con cambios de dirección de 90°.
- > Difusor Policarbonato Opal.
- > Cuerpo en perfil de aluminio extruido.

**QUICK INFO**

**GENERAL**

Trimless  
 IP43 (Optic)  
 IP20  
 IK05  
 850°C  
 Class I  
 Ta= -20°C +35°C

**OPTIC**

Opal Polycarbonate

**LED**

Efficacy up to 172 lm/W  
 3000 K, 4000 K  
 CRI >80  
 Lifetime 72 000 H  
 L80/B10 @Tc=70°C

**ELETRICAL SYSTEM**

230V/50Hz  
 ON/OFF, DALI

**FINISHING**

RAL 9003 Matt White

**OPTIONS**

**GENERAL** (Individual Luminaire)

IP44 (Optic)  
 Class II

**LED**

2700 K, 5000 K, 6500 K  
 Tunable White, RGB, RGBW  
 CRI >90

**ELECTRICAL SYSTEM**

DSI, DIM 1-10V, Phase-cut

**CONTROL SYSTEM**

Bluetooth

**EMERGENCY**

1 Hour, 3 Hours  
 DALI 1 Hour, 3 Hours

**SENSORS**

Motion  
 Ambient Light  
 Motion & Ambient Light

**WELINE EDGE TRIMLESS**

**OPAL DIFFUSER**

c (mm)	Output (lm)	System (W)	ON/OFF	DALI
<b>3000 K</b>				
565	1241	13	33.42.55.31.000	33.42.55.31.030
706	1550	16	33.42.55.31.001	33.42.55.31.031
846	1860	19	33.42.55.31.002	33.42.55.31.032
987	2170	22	33.42.55.31.003	33.42.55.31.033
1127	2480	25	33.42.55.31.004	33.42.55.31.034
1408	3100	31	33.42.55.31.005	33.42.55.31.035
1689	3720	38	33.42.55.31.006	33.42.55.31.036
1970	4340	44	33.42.55.31.007	33.42.55.31.037
2252	4959	50	33.42.55.31.008	33.42.55.31.038
2533	5580	57	33.42.55.31.009	33.42.55.31.039
Corner 610x610	2480	25	33.42.55.31.500	33.42.55.31.503
<b>4000 K</b>				
565	1298	13	33.42.55.31.060	33.42.55.31.090
706	1622	16	33.42.55.31.061	33.42.55.31.091
846	1947	19	33.42.55.31.062	33.42.55.31.092
987	2271	22	33.42.55.31.063	33.42.55.31.093
1127	2595	25	33.42.55.31.064	33.42.55.31.094
1408	3244	31	33.42.55.31.065	33.42.55.31.095
1689	3893	38	33.42.55.31.066	33.42.55.31.096
1970	4542	44	33.42.55.31.067	33.42.55.31.097
2252	5190	50	33.42.55.31.068	33.42.55.31.098
2533	5839	57	33.42.55.31.069	33.42.55.31.099
Corner 610x610	2595	25	33.42.55.31.506	33.42.55.31.509

**COMPONENTS**

**END CAP (1pc)**



TYPE	COD
Matt White	35.42.55.30.000

**LINEAR COUPLER (2pcs)**



TYPE	COD
Coupler	35.42.85.20.000

**ON REQUEST (INDIVIDUAL LUMINAIRE)**

- > IP44 (OPTIC);
- > CLASS II.

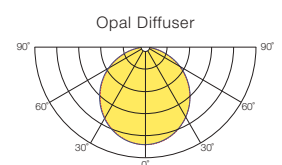
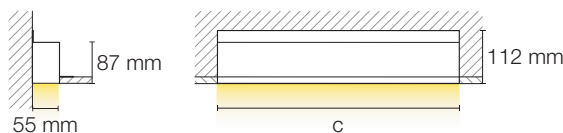

# WELINE DIRECT OR INDIRECT LIGHT WALL

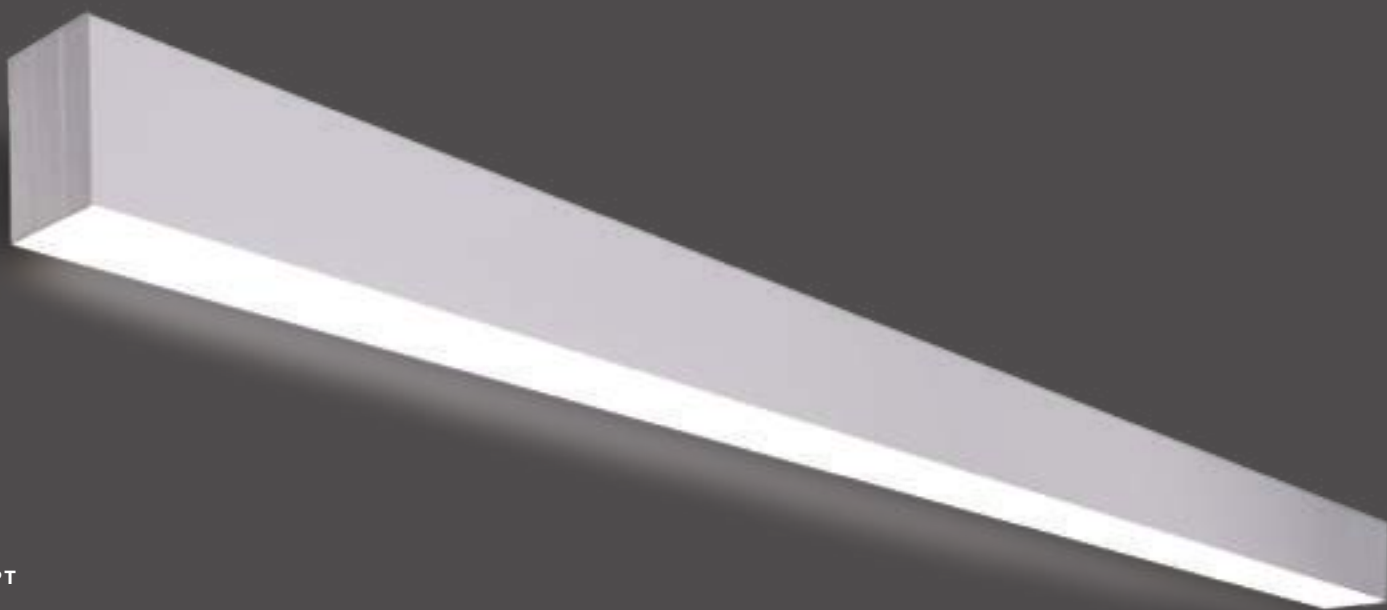

## PT

- > Luminária de parede com emissão direta ou indireta do fluxo luminoso.
- > Emissão direta ou indireta é definida pelo modo de aplicação.
- > Difusor Policarbonato Opal para iluminação homogénea, difusa e eficiente.
- > Corpo em perfil de alumínio extrudido.
- > Inclui topos injetados e sem parafusos.

## ES

- > Luminaria de pared con emisión directa o indirecta del flujo luminoso.
- > Emisión directa o indirecta es definida en la aplicación.
- > Difusor Policarbonato Opal.
- > Cuerpo en perfil de aluminio extruido.
- > Incluye tapas finales inyectadas y sin tornillos.

DIRECT LIGHT

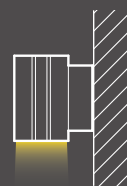

INDIRECT LIGHT



**QUICK INFO**

**GENERAL**

Wall  
 IP40  
 IK05  
 850°C  
 Class I  
 Ta= -20°C +35°C

**OPTIC**

Opal Polycarbonate

**LED**

Efficacy up to 172 lm/W  
 3000 K, 4000 K  
 CRI >80  
 Lifetime 72 000 H  
 L80/B10 @Tc=70°C

**ELETRICAL SYSTEM**

230V/50Hz  
 ON/OFF, DALI

**FINISHING**

RAL 9003 Matt White  
 Matt Anodized

**OPTIONS**

**LED**

2700 K, 5000 K, 6500 K  
 Tunable White, RGB, RGBW  
 CRI >90

**ELECTRICAL SYSTEM**

DSI, DIM 1-10V, Phase-cut

**CONTROL SYSTEM**

Bluetooth

**FINISHING**

 Other Colours

**EMERGENCY**

1 Hour, 3 Hours  
 DALI 1 Hour, 3 Hours

**SENSORS**

Motion  
 Ambient Light  
 Motion & Ambient Light

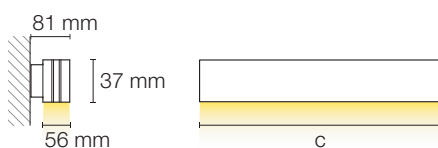

**WELINE WALL - DIRECT OR INDIRECT LIGHT  
 OPAL DIFFUSER**

**MATT WHITE FINISHING**

c (mm)	Output (lm)	System (W)	ON/OFF	DALI
<b>3000 K</b>				
568	1241	13	33.42.55.40.008	—
	2480	25	33.42.55.40.012	—
849	1860	19	33.42.55.40.009	33.42.55.40.022
	3720	38	33.42.55.40.013	33.42.55.40.025
1130	2480	25	33.42.55.40.010	33.42.55.40.023
	4961	50	33.42.55.40.014	33.42.55.40.026
1411	3100	31	33.42.55.40.011	33.42.55.40.024
	6201	63	33.42.55.40.015	33.42.55.40.027
<b>4000 K</b>				
568	1298	13	33.42.55.40.036	—
	2595	25	33.42.55.40.040	—
849	1947	19	33.42.55.40.037	33.42.55.40.050
	3893	38	33.42.55.40.041	33.42.55.40.053
1130	2595	25	33.42.55.40.038	33.42.55.40.051
	5190	50	33.42.55.40.042	33.42.55.40.054
1411	3244	31	33.42.55.40.039	33.42.55.40.052
	6488	63	33.42.55.40.043	33.42.55.40.055

**MATT ANODIZED FINISHING**

c (mm)	Output (lm)	System (W)	ON/OFF	DALI
<b>3000 K</b>				
568	1241	13	33.42.55.40.000	—
	2480	25	33.42.55.40.004	—
849	1860	19	33.42.55.40.001	33.42.55.40.016
	3720	38	33.42.55.40.005	33.42.55.40.019
1130	2480	25	33.42.55.40.002	33.42.55.40.017
	4961	50	33.42.55.40.006	33.42.55.40.020
1411	3100	31	33.42.55.40.003	33.42.55.40.018
	6201	63	33.42.55.40.007	33.42.55.40.021
<b>4000 K</b>				
568	1298	13	33.42.55.40.028	—
	2595	25	33.42.55.40.032	—
849	1947	19	33.42.55.40.029	33.42.55.40.044
	3893	38	33.42.55.40.033	33.42.55.40.047
1130	2595	25	33.42.55.40.030	33.42.55.40.045
	5190	50	33.42.55.40.034	33.42.55.40.048
1411	3244	31	33.42.55.40.031	33.42.55.40.046
	6488	63	33.42.55.40.035	33.42.55.40.049

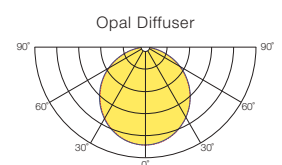

# WELINE DIRECT OR INDIRECT LIGHT WALL

## OPTIONS



### EMERGENCY (EM) - SELF-TEST INTEGRATED

#### ON/OFF

#### COD

EM 1H 3W	35.00.003.01.23*
EM 3H 3W	35.00.003.01.24**

#### DALI

#### COD

EM 1H 5,4W DALI	35.00.004.01.54*
EM 3H 5,4W DALI	35.00.004.01.55**

\* Applies to lengths equal to or greater than 1130 mm. \*\* Applies to lengths equal to or greater than 1411 mm.  
 > On request - External Emergency. Box dimensions: 45x120x360 mm.





**OMEGA XS**  
SUSPENDED





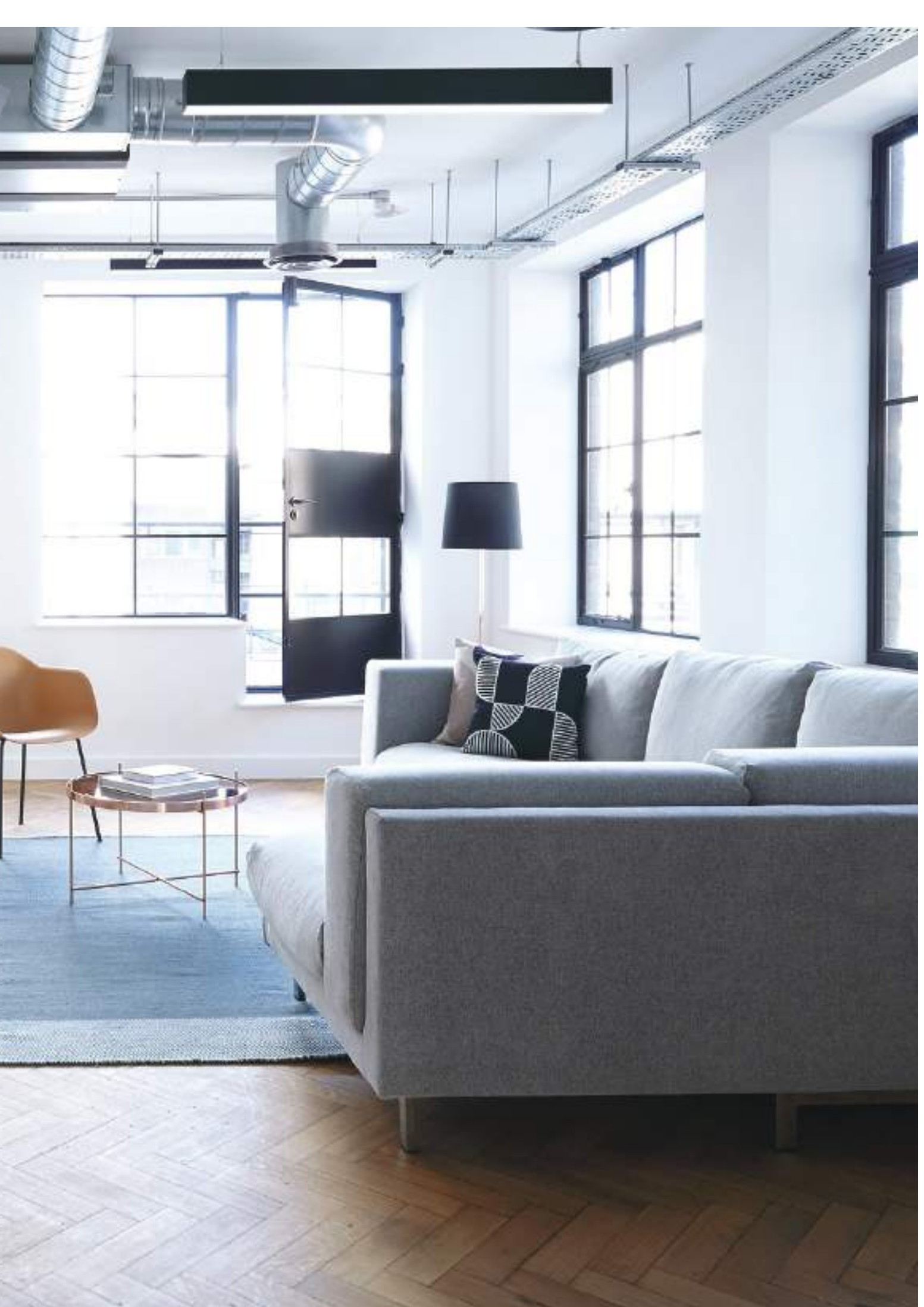

# OMEGA XS DIRECT LIGHT SUSPENDED

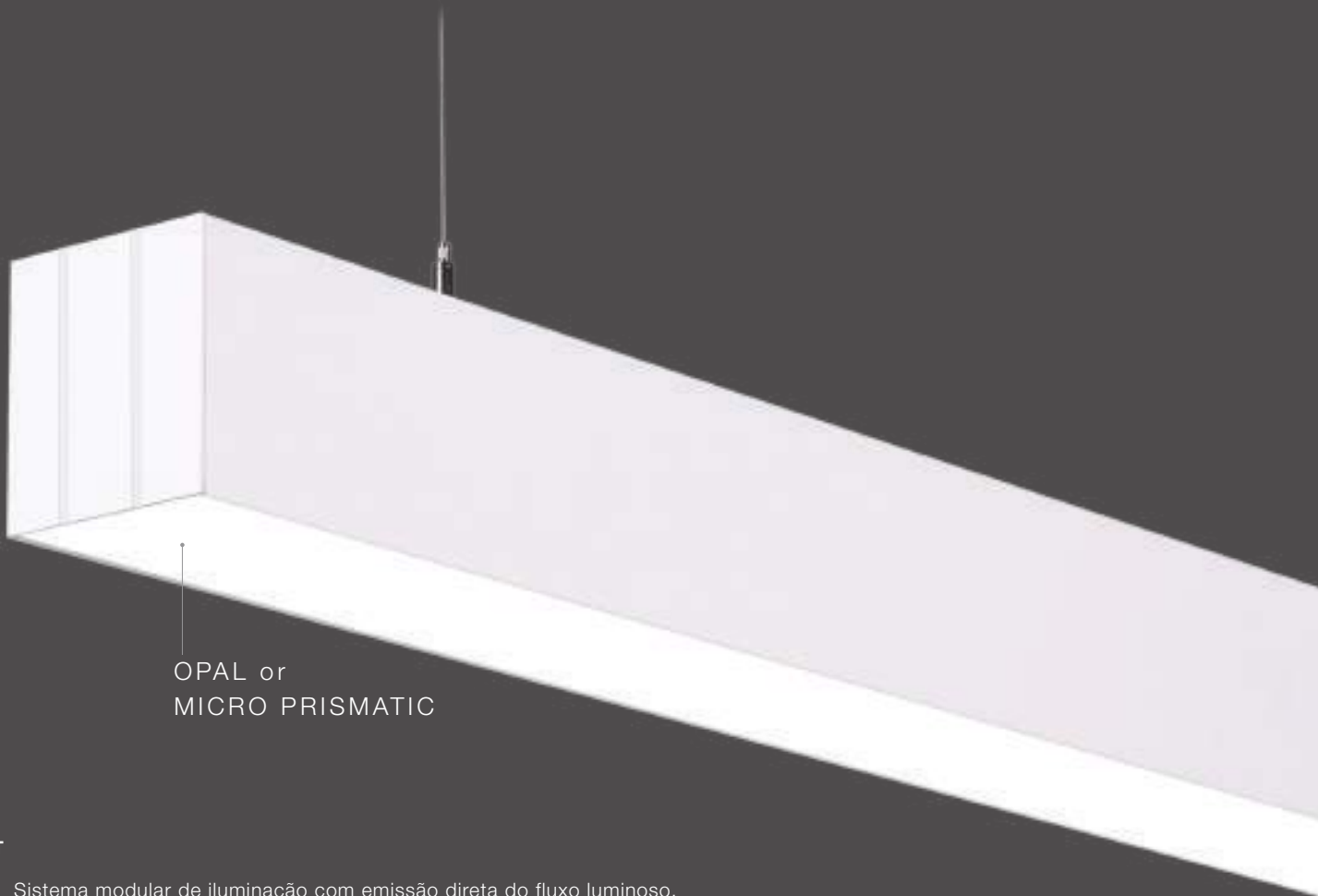

## PT

- > Sistema modular de iluminação com emissão direta do fluxo luminoso.
- > De aplicação suspensa por cabos de aço inox com ajuste rápido da altura.
- > Pode ser usado como luminária individual, sistema em linha contínua ou formas geométricas.
- > Cantos iluminados que permitem luz uniforme sem interrupções em linhas contínuas com mudanças de direção a 90°.
- > Difusor Policarbonato Microprismático para controlo do encandeamento (UGR <19) ou difusor Policarbonato Opal.
- > Corpo em perfil de alumínio extrudido.
- > Topos injetados e sem parafusos.

## ES

- > Sistema modular de iluminación con emisión directa del flujo luminoso.
- > De aplicación suspendida por cables de acero inoxidable con regulación de la altura.
- > Se puede usar como luminaria individual, sistema en línea continua o formas geométricas.
- > Esquinas iluminadas aseguran luz uniforme sin interrupciones en las líneas continuas con cambios de dirección de 90°.
- > Difusor Policarbonato Microprismático para control del deslumbramiento (UGR <19) o difusor Policarbonato Opal.
- > Cuerpo en perfil de aluminio extruido.
- > Tapas finales inyectadas y sin tornillos.

**QUICK INFO**

**GENERAL**

Suspended  
 IP40  
 IK05  
 850°C  
 Class I  
 Ta= -20°C +35°C

**OPTIC**

Opal Polycarbonate

**LED**

Efficacy up to 171 lm/W  
 3000 K, 4000 K  
 CRI >80  
 Lifetime 72 000 H  
 L80/B10 @Tc=65°C

**ELETRICAL SYSTEM**

230V/50Hz  
 ON/OFF, DALI

**FINISHING**

RAL 9003 Matt White

**OPTIONS**

**LED**

2700 K, 5000 K, 6500 K  
 Tunable White, RGB, RGBW  
 CRI >90

**ELECTRICAL SYSTEM**

DSI, DIM 1-10V, Phase-cut

**CONTROL SYSTEM**

Bluetooth

**FINISHING**

 Other Colours

**EMERGENCY**

1 Hour, 3 Hours  
 DALI 1 Hour, 3 Hours

**SENSORS**

Motion  
 Ambient Light  
 Motion & Ambient Light

**OMEGA XS SUSPENDED - DIRECT LIGHT  
 OPAL DIFFUSER**

**MATT WHITE FINISHING**

c (mm)	Output (lm)	System (W)	ON/OFF	DALI
<b>3000 K</b>				
845	1888	19	33.42.85.00.000	33.42.85.00.020
	3776	38	33.42.85.00.010	33.42.85.00.030
1126	2517	25	33.42.85.00.001	33.42.85.00.021
	5035	50	33.42.85.00.011	33.42.85.00.031
1407	3146	31	33.42.85.00.002	33.42.85.00.022
	6293	63	33.42.85.00.012	33.42.85.00.032
2250	5034	50	33.42.85.00.003	33.42.85.00.023
	10070	101	33.42.85.00.013	33.42.85.00.033
2812	6293	63	33.42.85.00.004	33.42.85.00.024
	12587	126	33.42.85.00.014	33.42.85.00.034
Corner 615x615	2517	25	33.42.85.00.502	33.42.85.00.510
	5035	50	33.42.85.00.503	33.42.85.00.511
<b>4000 K</b>				
845	1976	19	33.42.85.00.040	33.42.85.00.060
	3951	38	33.42.85.00.050	33.42.85.00.070
1126	2634	25	33.42.85.00.041	33.42.85.00.061
	5268	50	33.42.85.00.051	33.42.85.00.071
1407	3293	31	33.42.85.00.042	33.42.85.00.062
	6585	63	33.42.85.00.052	33.42.85.00.072
2250	5268	50	33.42.85.00.043	33.42.85.00.063
	10536	101	33.42.85.00.053	33.42.85.00.073
2812	6586	63	33.42.85.00.044	33.42.85.00.064
	13170	126	33.42.85.00.054	33.42.85.00.074
Corner 615x615	2634	25	33.42.85.00.518	33.42.85.00.526
	5268	50	33.42.85.00.519	33.42.85.00.527

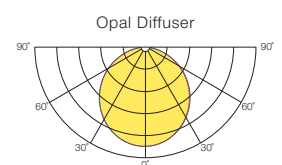
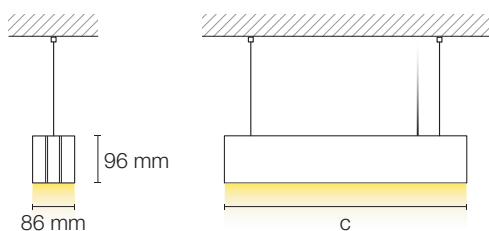

**QUICK INFO**

**GENERAL**

Suspended  
 IP40  
 IK05  
 850°C  
 Class I  
 Ta= -20°C +35°C

**OPTIC**

Opal Polycarbonate

**LED**

Efficacy up to 171 lm/W  
 3000 K, 4000 K  
 CRI >80  
 Lifetime 72 000 H  
 L80/B10 @Tc=65°C

**ELETRICAL SYSTEM**

230V/50Hz  
 ON/OFF, DALI

**FINISHING**

Matt Anodized

**OPTIONS**

**LED**

2700 K, 5000 K, 6500 K  
 Tunable White, RGB, RGBW  
 CRI >90

**ELECTRICAL SYSTEM**

DSI, DIM 1-10V, Phase-cut

**CONTROL SYSTEM**

Bluetooth

**FINISHING**

 Other Colours

**EMERGENCY**

1 Hour, 3 Hours  
 DALI 1 Hour, 3 Hours

**SENSORS**

Motion  
 Ambient Light  
 Motion & Ambient Light

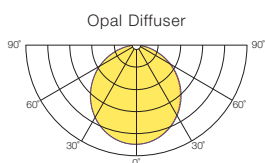

**OMEGA XS SUSPENDED - DIRECT LIGHT  
 OPAL DIFFUSER**

**MATT ANODIZED FINISHING**

c (mm)	Output (lm)	System (W)	ON/OFF	DALI
<b>3000 K</b>				
845	1888	19	33.42.85.00.005	33.42.85.00.025
	3776	38	33.42.85.00.015	33.42.85.00.035
1126	2517	25	33.42.85.00.006	33.42.85.00.026
	5035	50	33.42.85.00.016	33.42.85.00.036
1407	3146	31	33.42.85.00.007	33.42.85.00.027
	6293	63	33.42.85.00.017	33.42.85.00.037
2250	5034	50	33.42.85.00.008	33.42.85.00.028
	10070	101	33.42.85.00.018	33.42.85.00.038
2812	6293	63	33.42.85.00.009	33.42.85.00.029
	12587	126	33.42.85.00.019	33.42.85.00.039
Corner 615x615	2517	25	33.42.85.00.500	33.42.85.00.508
	5035	50	33.42.85.00.501	33.42.85.00.509
<b>4000 K</b>				
845	1976	19	33.42.85.00.045	33.42.85.00.065
	3951	38	33.42.85.00.055	33.42.85.00.075
1126	2634	25	33.42.85.00.046	33.42.85.00.066
	5268	50	33.42.85.00.056	33.42.85.00.076
1407	3293	31	33.42.85.00.047	33.42.85.00.067
	6585	63	33.42.85.00.057	33.42.85.00.077
2250	5268	50	33.42.85.00.048	33.42.85.00.068
	10536	101	33.42.85.00.058	33.42.85.00.078
2812	6586	63	33.42.85.00.049	33.42.85.00.069
	13170	126	33.42.85.00.059	33.42.85.00.079
Corner 615x615	2634	25	33.42.85.00.516	33.42.85.00.524
	5268	50	33.42.85.00.517	33.42.85.00.525

**DESCRIPTION**

- 1 > DRIVER
- 2 > LED BOARD
- 3 > LED COVER
- 4 > REFLECTOR
- 5 > DIFFUSER
- 6 > SUSPENSION

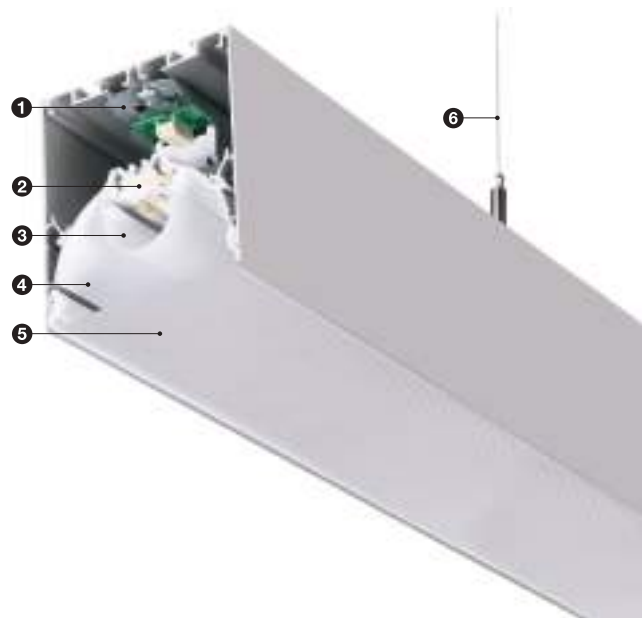

**QUICK INFO**

**GENERAL**

Suspended  
 IP40  
 IK05  
 850°C  
 Class I  
 Ta= -20°C +35°C

**OPTIC**

Micro Prismatic Polycarbonate  
 UGR <19

**LED**

Efficacy up to 171 lm/W  
 3000 K, 4000 K  
 CRI >80  
 Lifetime 72 000 H  
 L80/B10 @Tc=65°C

**ELETRICAL SYSTEM**

230V/50Hz  
 ON/OFF, DALI

**FINISHING**

RAL 9003 Matt White

**OPTIONS**

**LED**

2700 K, 5000 K, 6500 K  
 Tunable White, RGB, RGBW  
 CRI >90

**ELECTRICAL SYSTEM**

DSI, DIM 1-10V, Phase-cut

**CONTROL SYSTEM**

Bluetooth

**FINISHING**

 Other Colours

**EMERGENCY**

1 Hour, 3 Hours  
 DALI 1 Hour, 3 Hours

**SENSORS**

Motion  
 Ambient Light  
 Motion & Ambient Light

**OMEGA XS SUSPENDED - DIRECT LIGHT  
 MICRO PRISMATIC DIFFUSER - UGR <19**

**MATT WHITE FINISHING**

c (mm)	Output (lm)	System (W)	ON/OFF	DALI
<b>3000 K</b>				
845	1422	19	33.42.85.00.080	33.42.85.00.100
	2843	38	33.42.85.00.090	33.42.85.00.110
1126	1895	25	33.42.85.00.081	33.42.85.00.101
	3791	50	33.42.85.00.091	33.42.85.00.111
1407	2369	31	33.42.85.00.082	33.42.85.00.102
	4739	63	33.42.85.00.092	33.42.85.00.112
2250	3790	50	33.42.85.00.083	33.42.85.00.103
	7583	101	33.42.85.00.093	33.42.85.00.113
2812	4739	63	33.42.85.00.084	33.42.85.00.104
	9478	126	33.42.85.00.094	33.42.85.00.114
Corner 615x615	1895	25	33.42.85.00.506	33.42.85.00.514
	3791	50	33.42.85.00.507	33.42.85.00.515
<b>4000 K</b>				
845	1488	19	33.42.85.00.120	33.42.85.00.140
	2975	38	33.42.85.00.130	33.42.85.00.150
1126	1983	25	33.42.85.00.121	33.42.85.00.141
	3967	50	33.42.85.00.131	33.42.85.00.151
1407	2480	31	33.42.85.00.122	33.42.85.00.142
	4959	63	33.42.85.00.132	33.42.85.00.152
2250	3967	50	33.42.85.00.123	33.42.85.00.143
	7934	101	33.42.85.00.133	33.42.85.00.153
2812	4959	63	33.42.85.00.124	33.42.85.00.144
	9917	126	33.42.85.00.134	33.42.85.00.154
Corner 615x615	1983	25	33.42.85.00.522	33.42.85.00.530
	3967	50	33.42.85.00.523	33.42.85.00.531

Micro Prismatic Diffuser - UGR<19

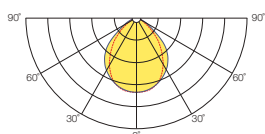

**QUICK INFO**

**GENERAL**

Suspended  
 IP40  
 IK05  
 850°C  
 Class I  
 Ta= -20°C +35°C

**OPTIC**

Micro Prismatic Polycarbonate  
 UGR <19

**LED**

Efficacy up to 171 lm/W  
 3000 K, 4000 K  
 CRI >80  
 Lifetime 72 000 H  
 L80/B10 @Tc=65°C

**ELETRICAL SYSTEM**

230V/50Hz  
 ON/OFF, DALI

**FINISHING**

Matt Anodized

**OPTIONS**

**LED**

2700 K, 5000 K, 6500 K  
 Tunable White, RGB, RGBW  
 CRI >90

**ELECTRICAL SYSTEM**

DSI, DIM 1-10V, Phase-cut

**CONTROL SYSTEM**

Bluetooth

**FINISHING**

 Other Colours

**EMERGENCY**

1 Hour, 3 Hours  
 DALI 1 Hour, 3 Hours

**SENSORS**

Motion  
 Ambient Light  
 Motion & Ambient Light

**OMEGA XS SUSPENDED - DIRECT LIGHT  
 MICRO PRISMATIC DIFFUSER - UGR <19**

**MATT ANODIZED FINISHING**

c (mm)	Output (lm)	System (W)	ON/OFF	DALI
<b>3000 K</b>				
845	1422	19	33.42.85.00.085	33.42.85.00.105
	2843	38	33.42.85.00.095	33.42.85.00.115
1126	1895	25	33.42.85.00.086	33.42.85.00.106
	3791	50	33.42.85.00.096	33.42.85.00.116
1407	2369	31	33.42.85.00.087	33.42.85.00.107
	4739	63	33.42.85.00.097	33.42.85.00.117
2250	3790	50	33.42.85.00.088	33.42.85.00.108
	7583	101	33.42.85.00.098	33.42.85.00.118
2812	4739	63	33.42.85.00.089	33.42.85.00.109
	9478	126	33.42.85.00.099	33.42.85.00.119
Corner 615x615	1895	25	33.42.85.00.504	33.42.85.00.512
	3791	50	33.42.85.00.505	33.42.85.00.513
<b>4000 K</b>				
845	1488	19	33.42.85.00.125	33.42.85.00.145
	2975	38	33.42.85.00.135	33.42.85.00.155
1126	1983	25	33.42.85.00.126	33.42.85.00.146
	3967	50	33.42.85.00.136	33.42.85.00.156
1407	2480	31	33.42.85.00.127	33.42.85.00.147
	4959	63	33.42.85.00.137	33.42.85.00.157
2250	3967	50	33.42.85.00.128	33.42.85.00.148
	7934	101	33.42.85.00.138	33.42.85.00.158
2812	4959	63	33.42.85.00.129	33.42.85.00.149
	9917	126	33.42.85.00.139	33.42.85.00.159
Corner 615x615	1983	25	33.42.85.00.520	33.42.85.00.528
	3967	50	33.42.85.00.521	33.42.85.00.529

Micro Prismatic Diffuser - UGR<19

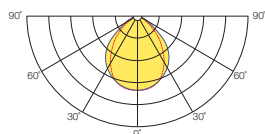



# OMEGA XS DIRECT LIGHT SUSPENDED

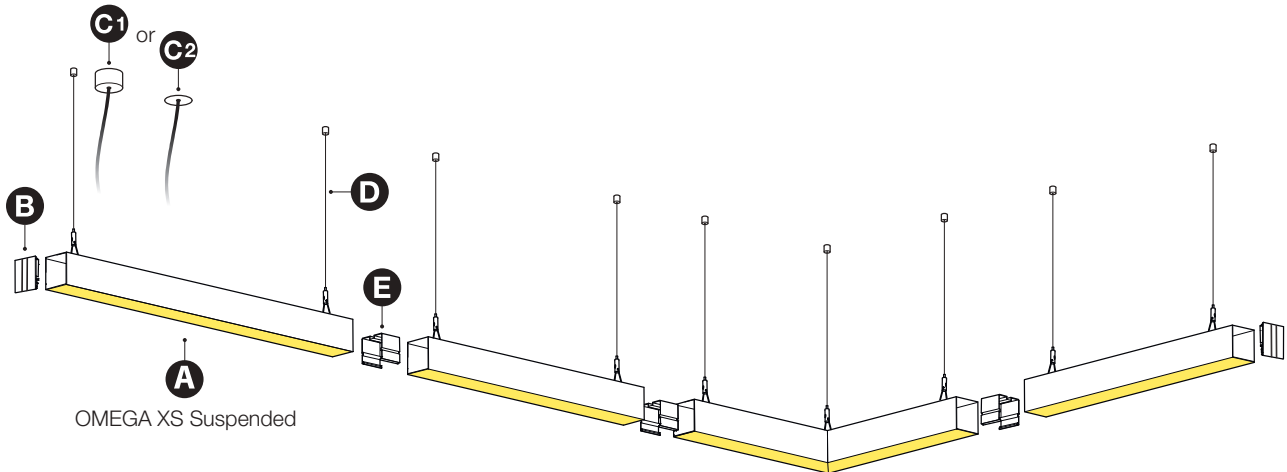

## COMPONENTS



### **B** END CAP (1pc)

	<b>COD</b>
Matt White	35.42.85.00.001
Matt Anodized Similar Painting	35.42.85.00.002



### **C1** SURFACE CEILING CUP (1pc)

MATT WHITE	DIMENSION	1m	3m	5m
ON/OFF	Ø62x36 mm	35.42.001.01.80	35.42.001.01.88	35.42.001.01.96
ON/OFF + EM	Ø62x36 mm	35.42.001.01.81	35.42.001.01.89	35.42.001.01.97
DALI	Ø62x36 mm	35.42.001.01.82	35.42.001.01.90	35.42.001.01.98
DALI + EM	Ø103x36 mm	35.42.001.01.83	35.42.001.01.91	35.42.001.01.99



### **C2** RECESSED CEILING CUP (1pc)

MATT WHITE	DIMENSION	1m	3m	5m
ON/OFF	Ø80 mm	35.42.001.01.84	35.42.001.01.92	35.42.002.01.00
ON/OFF + EM	Ø80 mm	35.42.001.01.85	35.42.001.01.93	35.42.002.01.01
DALI	Ø80 mm	35.42.001.01.86	35.42.001.01.94	35.42.002.01.02
DALI + EM	Ø80 mm	35.42.001.01.87	35.42.001.01.95	35.42.002.01.03



### **D** SUSPENSION SYSTEM (2pcs)

TYPE	1m	3m	5m
Matt White + Stainless Steel Cable	35.42.000.01.54	35.42.000.01.62	35.42.001.01.26



### **E** LINEAR COUPLER (1pc)

	<b>COD</b>
Coupler	35.42.85.00.000



OPTIONS



**EMERGENCY (EM) - SELF-TEST INTEGRATED**

ON/OFF	COD
EM 1H 3W	35.00.003.01.23*
EM 3H 3W	35.00.003.01.24**
DALI	COD
EM 1H 5,4W DALI	35.00.004.01.54*
EM 3H 5,4W DALI	35.00.004.01.55**

\* Applies to lengths equal to or greater than 1126 mm. \*\* Applies to lengths equal to or greater than 1407 mm.  
 > On request – External Emergency. Box dimensions: 45x120x360 mm.



# OMEGA XS

## SURFACE



OPAL or  
MICRO PRISMATIC

### PT

- > Sistema modular de iluminação para aplicação saliente.
- > Pode ser usado como luminária individual, sistema em linha contínua ou formas geométricas.
- > Cantos iluminados que permitem luz uniforme sem interrupções em linhas contínuas com mudanças de direção a 90°.
- > Difusor Policarbonato Microprismático para controlo do encandeamento (UGR <19) ou difusor Policarbonato Opal.
- > Corpo em perfil de alumínio extrudido.
- > Topos injetados e sem parafusos.

### ES

- > Sistema modular de iluminación para instalación en superficie.
- > Se puede usar como luminaria individual, sistema en línea continua o formas geométricas.
- > Esquinas iluminadas aseguran luz uniforme sin interrupciones en las líneas continuas con cambios de dirección de 90°.
- > Difusor Policarbonato Microprismático para control del deslumbramiento (UGR <19) o difusor Policarbonato Opal.
- > Cuerpo en perfil de aluminio extruido.
- > Tapas finales inyectadas y sin tornillos.

**QUICK INFO**

**GENERAL**

Surface  
 IP40  
 IK05  
 850°C  
 Class I  
 Ta= -20°C +35°C

**OPTIC**

Opal Polycarbonate

**LED**

Efficacy up to 171 lm/W  
 3000 K, 4000 K  
 CRI >80  
 Lifetime 72 000 H  
 L80/B10 @Tc=65°C

**ELETRICAL SYSTEM**

230V/50Hz  
 ON/OFF, DALI

**FINISHING**

RAL 9003 Matt White

**OPTIONS**

**LED**

2700 K, 5000 K, 6500 K  
 Tunable White, RGB, RGBW  
 CRI >90

**ELECTRICAL SYSTEM**

DSI, DIM 1-10V, Phase-cut

**CONTROL SYSTEM**

Bluetooth

**FINISHING**

 Other Colours

**EMERGENCY**

1 Hour, 3 Hours  
 DALI 1 Hour, 3 Hours

**SENSORS**

Motion  
 Ambient Light  
 Motion & Ambient Light

**OMEGA XS SURFACE**

**OPAL DIFFUSER**

**MATT WHITE FINISHING**

c (mm)	Output (lm)	System (W)	ON/OFF	DALI
<b>3000 K</b>				
845	1888	19	33.42.85.10.000	33.42.85.10.020
	3776	38	33.42.85.10.010	33.42.85.10.030
1126	2517	25	33.42.85.10.001	33.42.85.10.021
	5035	50	33.42.85.10.011	33.42.85.10.031
1407	3146	31	33.42.85.10.002	33.42.85.10.022
	6293	63	33.42.85.10.012	33.42.85.10.032
2250	5034	50	33.42.85.10.003	33.42.85.10.023
	10070	101	33.42.85.10.013	33.42.85.10.033
2812	6293	63	33.42.85.10.004	33.42.85.10.024
	12587	126	33.42.85.10.014	33.42.85.10.034
Corner 615x615	2517	25	33.42.85.10.502	33.42.85.10.510
	5035	50	33.42.85.10.503	33.42.85.10.511
<b>4000 K</b>				
845	1976	19	33.42.85.10.040	33.42.85.10.060
	3951	38	33.42.85.10.050	33.42.85.10.070
1126	2634	25	33.42.85.10.041	33.42.85.10.061
	5268	50	33.42.85.10.051	33.42.85.10.071
1407	3293	31	33.42.85.10.042	33.42.85.10.062
	6585	63	33.42.85.10.052	33.42.85.10.072
2250	5268	50	33.42.85.10.043	33.42.85.10.063
	10536	101	33.42.85.10.053	33.42.85.10.073
2812	6586	63	33.42.85.10.044	33.42.85.10.064
	13170	126	33.42.85.10.054	33.42.85.10.074
Corner 615x615	2634	25	33.42.85.10.518	33.42.85.10.526
	5268	50	33.42.85.10.519	33.42.85.10.527

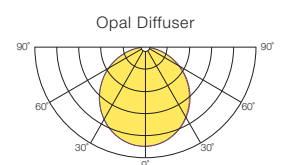
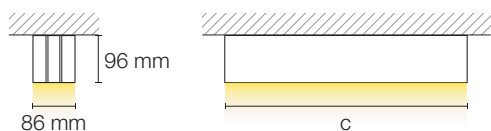

**QUICK INFO**

**GENERAL**

Surface  
 IP40  
 IK05  
 850°C  
 Class I  
 Ta= -20°C +35°C

**OPTIC**

Opal Polycarbonate

**LED**

Efficacy up to 171 lm/W  
 3000 K, 4000 K  
 CRI >80  
 Lifetime 72 000 H  
 L80/B10 @Tc=65°C

**ELETRICAL SYSTEM**

230V/50Hz  
 ON/OFF, DALI

**FINISHING**

Matt Anodized

**OPTIONS**

**LED**

2700 K, 5000 K, 6500 K  
 Tunable White, RGB, RGBW  
 CRI >90

**ELECTRICAL SYSTEM**

DSI, DIM 1-10V, Phase-cut

**CONTROL SYSTEM**

Bluetooth

**FINISHING**

 Other Colours

**EMERGENCY**

1 Hour, 3 Hours  
 DALI 1 Hour, 3 Hours

**SENSORS**

Motion  
 Ambient Light  
 Motion & Ambient Light

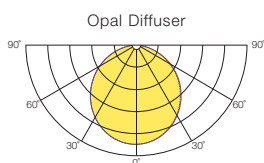

**OMEGA XS SURFACE**

**OPAL DIFFUSER**

**MATT ANODIZED FINISHING**

c (mm)	Output (lm)	System (W)	ON/OFF	DALI
<b>3000 K</b>				
845	1888	19	33.42.85.10.005	33.42.85.10.025
	3776	38	33.42.85.10.015	33.42.85.10.035
1126	2517	25	33.42.85.10.006	33.42.85.10.026
	5035	50	33.42.85.10.016	33.42.85.10.036
1407	3146	31	33.42.85.10.007	33.42.85.10.027
	6293	63	33.42.85.10.017	33.42.85.10.037
2250	5034	50	33.42.85.10.008	33.42.85.10.028
	10070	101	33.42.85.10.018	33.42.85.10.038
2812	6293	63	33.42.85.10.009	33.42.85.10.029
	12587	126	33.42.85.10.019	33.42.85.10.039
Corner 615x615	2517	25	33.42.85.10.500	33.42.85.10.508
	5035	50	33.42.85.10.501	33.42.85.10.509
<b>4000 K</b>				
845	1976	19	33.42.85.10.045	33.42.85.10.065
	3951	38	33.42.85.10.055	33.42.85.10.075
1126	2634	25	33.42.85.10.046	33.42.85.10.066
	5268	50	33.42.85.10.056	33.42.85.10.076
1407	3293	31	33.42.85.10.047	33.42.85.10.067
	6585	63	33.42.85.10.057	33.42.85.10.077
2250	5268	50	33.42.85.10.048	33.42.85.10.068
	10536	101	33.42.85.10.058	33.42.85.10.078
2812	6586	63	33.42.85.10.049	33.42.85.10.069
	13170	126	33.42.85.10.059	33.42.85.10.079
Corner 615x615	2634	25	33.42.85.10.516	33.42.85.10.524
	5268	50	33.42.85.10.517	33.42.85.10.525

**DESCRIPTION**

- 1 > DRIVER
- 2 > LED BOARD
- 3 > LED COVER
- 4 > REFLECTOR
- 5 > DIFFUSER

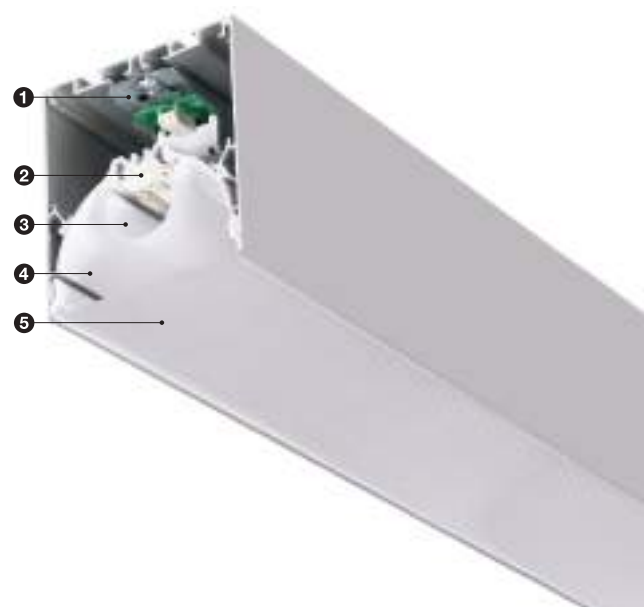

**QUICK INFO**

**GENERAL**

Surface  
 IP40  
 IK05  
 850°C  
 Class I  
 Ta= -20°C +35°C

**OPTIC**

Micro Prismatic Polycarbonate  
 UGR <19

**LED**

Efficacy up to 171 lm/W  
 3000 K, 4000 K  
 CRI >80  
 Lifetime 72 000 H  
 L80/B10 @Tc=65°C

**ELETRICAL SYSTEM**

230V/50Hz  
 ON/OFF, DALI

**FINISHING**

RAL 9003 Matt White

**OPTIONS**

**LED**

2700 K, 5000 K, 6500 K  
 Tunable White, RGB, RGBW  
 CRI >90

**ELECTRICAL SYSTEM**

DSI, DIM 1-10V, Phase-cut

**CONTROL SYSTEM**

Bluetooth

**FINISHING**

 Other Colours

**EMERGENCY**

1 Hour, 3 Hours  
 DALI 1 Hour, 3 Hours

**SENSORS**

Motion  
 Ambient Light  
 Motion & Ambient Light

**OMEGA XS SURFACE**

**MICRO PRISMATIC DIFFUSER - UGR <19**

**MATT WHITE FINISHING**

c (mm)	Output (lm)	System (W)	ON/OFF	DALI
<b>3000 K</b>				
845	1422	19	33.42.85.10.080	33.42.85.10.100
	2843	38	33.42.85.10.090	33.42.85.10.110
1126	1895	25	33.42.85.10.081	33.42.85.10.101
	3791	50	33.42.85.10.091	33.42.85.10.111
1407	2369	31	33.42.85.10.082	33.42.85.10.102
	4739	63	33.42.85.10.092	33.42.85.10.112
2250	3790	50	33.42.85.10.083	33.42.85.10.103
	7583	101	33.42.85.10.093	33.42.85.10.113
2812	4739	63	33.42.85.10.084	33.42.85.10.104
	9478	126	33.42.85.10.094	33.42.85.10.114
Corner 615x615	1895	25	33.42.85.10.506	33.42.85.10.514
	3791	50	33.42.85.10.507	33.42.85.10.515
<b>4000 K</b>				
845	1488	19	33.42.85.10.120	33.42.85.10.140
	2975	38	33.42.85.10.130	33.42.85.10.150
1126	1983	25	33.42.85.10.121	33.42.85.10.141
	3967	50	33.42.85.10.131	133.42.85.10.151
1407	2480	31	33.42.85.10.122	33.42.85.10.142
	4959	63	33.42.85.10.132	33.42.85.10.152
2250	3967	50	33.42.85.10.123	33.42.85.10.143
	7934	101	33.42.85.10.133	33.42.85.10.153
2812	4959	63	33.42.85.10.124	33.42.85.10.144
	9917	126	33.42.85.10.134	33.42.85.10.154
Corner 615x615	1983	25	33.42.85.10.522	33.42.85.10.530
	3967	50	33.42.85.10.523	33.42.85.10.531

Micro Prismatic Diffuser - UGR<19

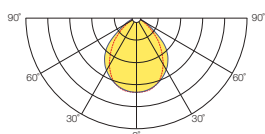

**QUICK INFO**

**GENERAL**

Surface  
 IP40  
 IK05  
 850°C  
 Class I  
 Ta= -20°C +35°C

**OPTIC**

Micro Prismatic Polycarbonate  
 UGR <19

**LED**

Efficacy up to 171 lm/W  
 3000 K, 4000 K  
 CRI >80  
 Lifetime 72 000 H  
 L80/B10 @Tc=65°C

**ELETRICAL SYSTEM**

230V/50Hz  
 ON/OFF, DALI

**FINISHING**

Matt Anodized

**OPTIONS**

**LED**

2700 K, 5000 K, 6500 K  
 Tunable White, RGB, RGBW  
 CRI >90

**ELECTRICAL SYSTEM**

DSI, DIM 1-10V, Phase-cut

**CONTROL SYSTEM**

Bluetooth

**FINISHING**

 Other Colours

**EMERGENCY**

1 Hour, 3 Hours  
 DALI 1 Hour, 3 Hours

**SENSORS**

Motion  
 Ambient Light  
 Motion & Ambient Light

**OMEGA XS SURFACE**

**MICRO PRISMATIC DIFFUSER - UGR <19**

**MATT ANODIZED FINISHING**

c (mm)	Output (lm)	System (W)	ON/OFF	DALI
<b>3000 K</b>				
845	1422	19	33.42.85.10.085	33.42.85.10.105
	2843	38	33.42.85.10.095	33.42.85.10.115
1126	1895	25	33.42.85.10.086	33.42.85.10.106
	3791	50	33.42.85.10.096	33.42.85.10.116
1407	2369	31	33.42.85.10.087	33.42.85.10.107
	4739	63	33.42.85.10.097	33.42.85.10.117
2250	3790	50	33.42.85.10.088	33.42.85.10.108
	7583	101	33.42.85.10.098	33.42.85.10.118
2812	4739	63	33.42.85.10.089	33.42.85.10.109
	9478	126	33.42.85.10.099	33.42.85.10.119
Corner 615x615	1895	25	33.42.85.10.504	33.42.85.10.512
	3791	50	33.42.85.10.505	33.42.85.10.513
<b>4000 K</b>				
845	1488	19	33.42.85.10.125	33.42.85.10.145
	2975	38	33.42.85.10.135	33.42.85.10.155
1126	1983	25	33.42.85.10.126	33.42.85.10.146
	3967	50	33.42.85.10.136	33.42.85.10.156
1407	2480	31	33.42.85.10.127	33.42.85.10.147
	4959	63	33.42.85.10.137	33.42.85.10.157
2250	3967	50	33.42.85.10.128	33.42.85.10.148
	7934	101	33.42.85.10.138	33.42.85.10.158
2812	4959	63	33.42.85.10.129	33.42.85.10.149
	9917	126	33.42.85.10.139	33.42.85.10.159
Corner 615x615	1983	25	33.42.85.10.520	33.42.85.10.528
	3967	50	33.42.85.10.521	33.42.85.10.529

Micro Prismatic Diffuser - UGR<19

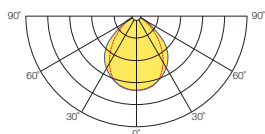

# OMEGA XS

## SURFACE

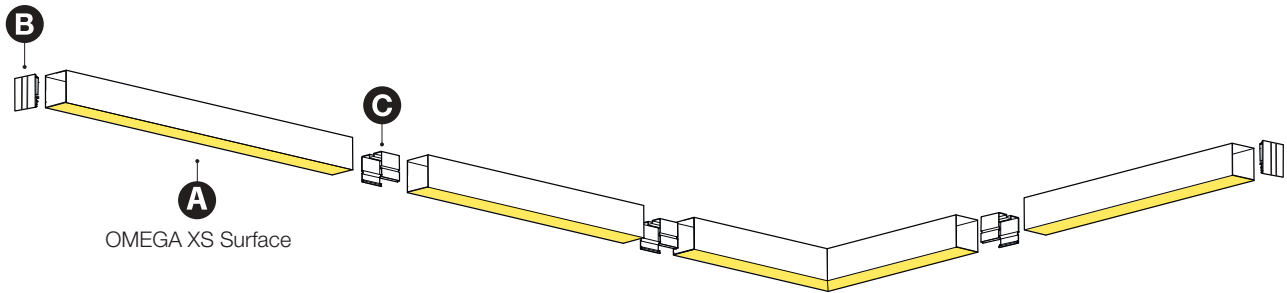

### COMPONENTS



<b>B</b> END CAP (1pc)	COD
Matt White	35.42.85.00.001
Matt Anodized Similar Painting	35.42.85.00.002



<b>C</b> LINEAR COUPLER (1pc)	COD
Coupler	35.42.85.00.000

### OPTIONS



#### EMERGENCY (EM) - SELF-TEST INTEGRATED

ON/OFF	COD
EM 1H 3W	35.00.003.01.23*
EM 3H 3W	35.00.003.01.24**
DALI	COD
EM 1H 5,4W DALI	35.00.004.01.54*
EM 3H 5,4W DALI	35.00.004.01.55**

\* Applies to lengths equal to or greater than 1126 mm. \*\* Applies to lengths equal to or greater than 1407 mm.  
 > On request - External Emergency. Box dimensions: 45x120x360 mm.

# OMEGA XS RECESSED

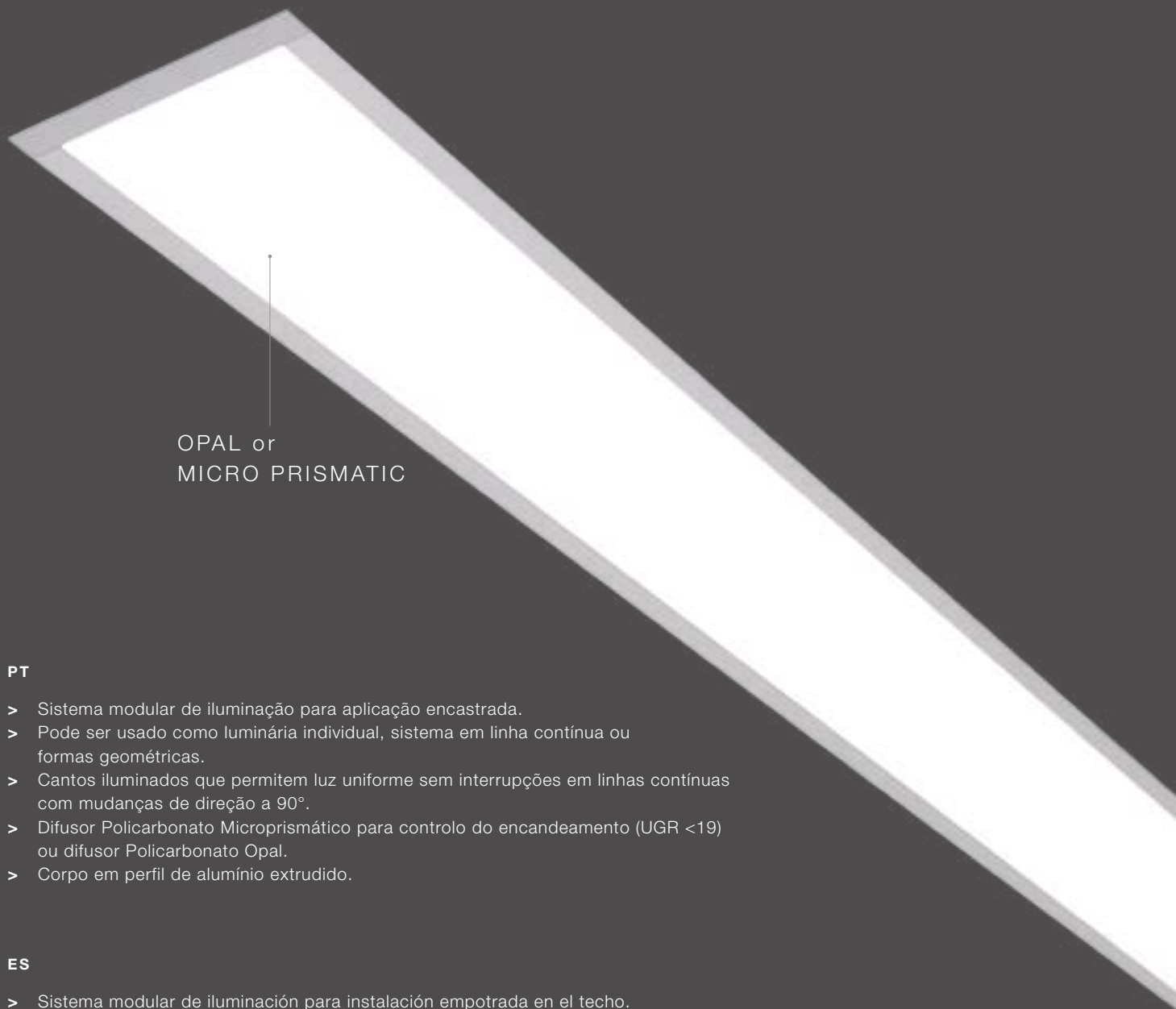

OPAL or  
MICRO PRISMATIC

## PT

- > Sistema modular de iluminação para aplicação encastrada.
- > Pode ser usado como luminária individual, sistema em linha contínua ou formas geométricas.
- > Cantos iluminados que permitem luz uniforme sem interrupções em linhas contínuas com mudanças de direção a 90°.
- > Difusor Policarbonato Microprismático para controlo do encandeamento (UGR <19) ou difusor Policarbonato Opal.
- > Corpo em perfil de alumínio extrudido.

## ES

- > Sistema modular de iluminación para instalación empotrada en el techo.
- > Se puede usar como luminaria individual, sistema en línea continua o formas geométricas.
- > Esquinas iluminadas aseguran luz uniforme sin interrupciones en las líneas continuas con cambios de dirección de 90°.
- > Difusor Policarbonato Microprismático para control del deslumbramiento (UGR <19) o difusor Policarbonato Opal.
- > Cuerpo en perfil de aluminio extruido.



**QUICK INFO**

**GENERAL**

Recessed  
 IP43 (Optic)  
 IP20  
 IK05  
 850°C  
 Class I  
 Ta= -20°C +35°C

**OPTIC**

Opal Polycarbonate

**LED**

Efficacy up to 171 lm/W  
 3000 K, 4000 K  
 CRI >80  
 Lifetime 72 000 H  
 L80/B10 @Tc=65°C

**ELECTRICAL SYSTEM**

230V/50Hz  
 ON/OFF, DALI

**FINISHING**

RAL 9003 Matt White

**OPTIONS**

**GENERAL** (Individual Luminaire)

IP44 (Optic)  
 Class II

**LED**

2700 K, 5000 K, 6500 K  
 Tunable White, RGB, RGBW  
 CRI >90

**ELECTRICAL SYSTEM**

DSI, DIM 1-10V, Phase-cut

**CONTROL SYSTEM**

Bluetooth

**FINISHING**

 Other Colours

**EMERGENCY**

1 Hour, 3 Hours  
 DALI 1 Hour, 3 Hours

**SENSORS**

Motion  
 Ambient Light  
 Motion & Ambient Light

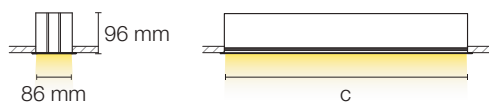

**OMEGA XS RECESSED**

**OPAL DIFFUSER**

**MATT WHITE FINISHING**

c (mm)	Output (lm)	System (W)	ON/OFF	DALI
<b>3000 K</b>				
845	1888	19	33.42.85.20.000	33.42.85.20.020
	3776	38	33.42.85.20.010	33.42.85.20.030
1126	2517	25	33.42.85.20.001	33.42.85.20.021
	5035	50	33.42.85.20.011	33.42.85.20.031
1407	3146	31	33.42.85.20.002	33.42.85.20.022
	6293	63	33.42.85.20.012	33.42.85.20.032
2250	5034	50	33.42.85.20.003	33.42.85.20.023
	10070	101	33.42.85.20.013	33.42.85.20.033
2812	6293	63	33.42.85.20.004	33.42.85.20.024
	12587	126	33.42.85.20.014	33.42.85.20.034
Corner 625x625	2517	25	33.42.85.20.502	33.42.85.20.510
	5035	50	33.42.85.20.503	33.42.85.20.511
<b>4000 K</b>				
845	1976	19	33.42.85.20.040	33.42.85.20.060
	3951	38	33.42.85.20.050	33.42.85.20.070
1126	2634	25	33.42.85.20.041	33.42.85.20.061
	5268	50	33.42.85.20.051	33.42.85.20.071
1407	3293	31	33.42.85.20.042	33.42.85.20.062
	6585	63	33.42.85.20.052	33.42.85.20.072
2250	5268	50	33.42.85.20.043	33.42.85.20.063
	10536	101	33.42.85.20.053	33.42.85.20.073
2812	6586	63	33.42.85.20.044	33.42.85.20.064
	13170	126	33.42.85.20.054	33.42.85.20.074
Corner 625x625	2634	25	33.42.85.20.518	33.42.85.20.526
	5268	50	33.42.85.20.519	33.42.85.20.527

**ON REQUEST (INDIVIDUAL LUMINAIRE)**

- > IP44 (OPTIC);
- > CLASS II.

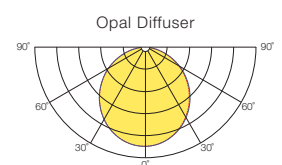

**QUICK INFO**

**GENERAL**

Recessed  
 IP43 (Optic)  
 IP20  
 IK05  
 850°C  
 Class I  
 Ta= -20°C +35°C

**OPTIC**

Opal Polycarbonate

**LED**

Efficacy up to 171 lm/W  
 3000 K, 4000 K  
 CRI >80  
 Lifetime 72 000 H  
 L80/B10 @Tc=65°C

**ELETRICAL SYSTEM**

230V/50Hz  
 ON/OFF, DALI

**FINISHING**

Matt Anodized

**OPTIONS**

**GENERAL** (Individual Luminaire)

IP44 (Optic)  
 Class II

**LED**

2700 K, 5000 K, 6500 K  
 Tunable White, RGB, RGBW  
 CRI >90

**ELECTRICAL SYSTEM**

DSI, DIM 1-10V, Phase-cut

**CONTROL SYSTEM**

Bluetooth

**FINISHING**

 Other Colours

**EMERGENCY**

1 Hour, 3 Hours  
 DALI 1 Hour, 3 Hours

**SENSORS**

Motion  
 Ambient Light  
 Motion & Ambient Light

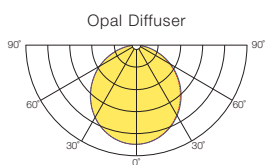

**OMEGA XS RECESSED  
 OPAL DIFFUSER**

**MATT ANODIZED FINISHING**

c (mm)	Output (lm)	System (W)	ON/OFF	DALI
<b>3000 K</b>				
845	1888	19	33.42.85.20.005	33.42.85.20.025
	3776	38	33.42.85.20.015	33.42.85.20.035
1126	2517	25	33.42.85.20.006	33.42.85.20.026
	5035	50	33.42.85.20.016	33.42.85.20.036
1407	3146	31	33.42.85.20.007	33.42.85.20.027
	6293	63	33.42.85.20.017	33.42.85.20.037
2250	5034	50	33.42.85.20.008	33.42.85.20.028
	10070	101	33.42.85.20.018	33.42.85.20.038
2812	6293	63	33.42.85.20.009	33.42.85.20.029
	12587	126	33.42.85.20.019	33.42.85.20.039
Corner 625x625	2517	25	33.42.85.20.500	33.42.85.20.508
	5035	50	33.42.85.20.501	33.42.85.20.509
<b>4000 K</b>				
845	1976	19	33.42.85.20.045	33.42.85.20.065
	3951	38	33.42.85.20.055	33.42.85.20.075
1126	2634	25	33.42.85.20.046	33.42.85.20.066
	5268	50	33.42.85.20.056	33.42.85.20.076
1407	3293	31	33.42.85.20.047	33.42.85.20.067
	6585	63	33.42.85.20.057	33.42.85.20.077
2250	5268	50	33.42.85.20.048	33.42.85.20.068
	10536	101	33.42.85.20.058	33.42.85.20.078
2812	6586	63	33.42.85.20.049	33.42.85.20.069
	13170	126	33.42.85.20.059	33.42.85.20.079
Corner 625x625	2634	25	33.42.85.20.516	33.42.85.20.524
	5268	50	33.42.85.20.517	33.42.85.20.525

**DESCRIPTION**

- 1 > DRIVER
- 2 > LED BOARD
- 3 > LED COVER
- 4 > REFLECTOR
- 5 > DIFFUSER

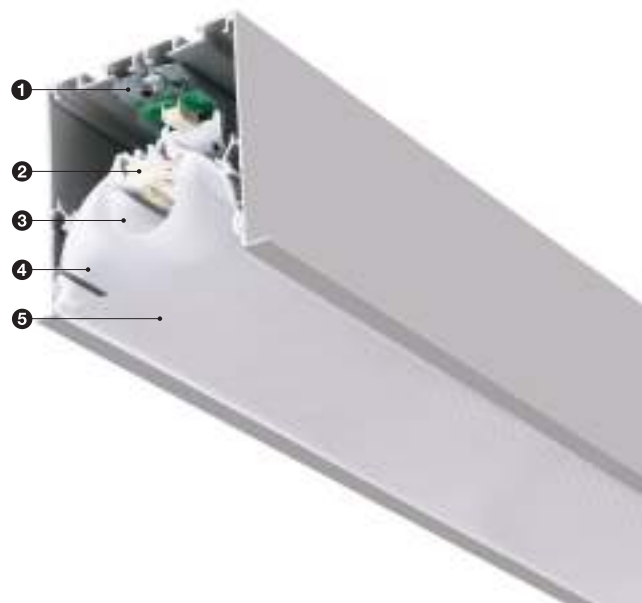

**QUICK INFO**

**GENERAL**

Recessed  
 IP43 (Optic)  
 IP20  
 IK05  
 850°C  
 Class I  
 Ta= -20°C +35°C

**OPTIC**

Micro Prismatic Polycarbonate  
 UGR <19

**LED**

Efficacy up to 171 lm/W  
 3000 K, 4000 K  
 CRI >80  
 Lifetime 72 000 H  
 L80/B10 @Tc=65°C

**ELETRICAL SYSTEM**

230V/50Hz  
 ON/OFF, DALI

**FINISHING**

RAL 9003 Matt White

**OPTIONS**

**GENERAL** (Individual Luminaire)

IP44 (Optic)  
 Class II

**LED**

2700 K, 5000 K, 6500 K  
 Tunable White, RGB, RGBW  
 CRI >90

**ELECTRICAL SYSTEM**

DSI, DIM 1-10V, Phase-cut

**CONTROL SYSTEM**

Bluetooth

**FINISHING**

 Other Colours

**EMERGENCY**

1 Hour, 3 Hours  
 DALI 1 Hour, 3 Hours

**SENSORS**

Motion  
 Ambient Light  
 Motion & Ambient Light

**OMEGA XS RECESSED**

**MICRO PRISMATIC DIFFUSER - UGR <19**

**MATT WHITE FINISHING**

c (mm)	Output (lm)	System (W)	ON/OFF	DALI
<b>3000 K</b>				
845	1422	19	33.42.85.20.080	33.42.85.20.100
	2843	38	33.42.85.20.090	33.42.85.20.110
1126	1895	25	33.42.85.20.081	33.42.85.20.101
	3791	50	33.42.85.20.091	33.42.85.20.111
1407	2369	31	33.42.85.20.082	33.42.85.20.102
	4739	63	33.42.85.20.092	33.42.85.20.112
2250	3790	50	33.42.85.20.083	33.42.85.20.103
	7583	101	33.42.85.20.093	33.42.85.20.113
2812	4739	63	33.42.85.20.084	33.42.85.20.104
	9478	126	33.42.85.20.094	33.42.85.20.114
Corner 625x625	1895	25	33.42.85.20.506	33.42.85.20.514
	3791	50	33.42.85.20.507	33.42.85.20.515
<b>4000 K</b>				
845	1488	19	33.42.85.20.120	33.42.85.20.140
	2975	38	33.42.85.20.130	33.42.85.20.150
1126	1983	25	33.42.85.20.121	33.42.85.20.141
	3967	50	33.42.85.20.131	33.42.85.20.151
1407	2480	31	33.42.85.20.122	33.42.85.20.142
	4959	63	33.42.85.20.132	33.42.85.20.152
2250	3967	50	33.42.85.20.123	33.42.85.20.143
	7934	101	33.42.85.20.133	33.42.85.20.153
2812	4959	63	33.42.85.20.124	33.42.85.20.144
	9917	126	33.42.85.20.134	33.42.85.20.154
Corner 625x625	1983	25	33.42.85.20.522	33.42.85.20.530
	3967	50	33.42.85.20.523	33.42.85.20.531

Micro Prismatic Diffuser - UGR<19

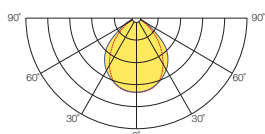

**QUICK INFO**

**GENERAL**

Recessed  
 IP43 (Optic)  
 IP20  
 IK05  
 850°C  
 Class I  
 Ta= -20°C +35°C

**OPTIC**

Micro Prismatic Polycarbonate  
 UGR <19

**LED**

Efficacy up to 171 lm/W  
 3000 K, 4000 K  
 CRI >80  
 Lifetime 72 000 H  
 L80/B10 @Tc=65°C

**ELETRICAL SYSTEM**

230V/50Hz  
 ON/OFF, DALI

**FINISHING**

Matt Anodized

**OPTIONS**

**GENERAL** (Individual Luminaire)

IP44 (Optic)  
 Class II

**LED**

2700 K, 5000 K, 6500 K  
 Tunable White, RGB, RGBW  
 CRI >90

**ELECTRICAL SYSTEM**

DSI, DIM 1-10V, Phase-cut

**CONTROL SYSTEM**

Bluetooth

**FINISHING**

 Other Colours

**EMERGENCY**

1 Hour, 3 Hours  
 DALI 1 Hour, 3 Hours

**SENSORS**

Motion  
 Ambient Light  
 Motion & Ambient Light

**OMEGA XS RECESSED**

**MICRO PRISMATIC DIFFUSER - UGR <19**

**MATT ANODIZED FINISHING**

c (mm)	Output (lm)	System (W)	ON/OFF	DALI
<b>3000 K</b>				
845	1422	19	33.42.85.20.085	33.42.85.20.105
	2843	38	33.42.85.20.095	33.42.85.20.115
1126	1895	25	33.42.85.20.086	33.42.85.20.106
	3791	50	33.42.85.20.096	33.42.85.20.116
1407	2369	31	33.42.85.20.087	33.42.85.20.107
	4739	63	33.42.85.20.097	33.42.85.20.117
2250	3790	50	33.42.85.20.088	33.42.85.20.108
	7583	101	33.42.85.20.098	33.42.85.20.118
2812	4739	63	33.42.85.20.089	33.42.85.20.109
	9478	126	33.42.85.20.099	33.42.85.20.119
Corner 625x625	1895	25	33.42.85.20.504	33.42.85.20.512
	3791	50	33.42.85.20.505	33.42.85.20.513
<b>4000 K</b>				
845	1488	19	33.42.85.20.125	33.42.85.20.145
	2975	38	33.42.85.20.135	33.42.85.20.155
1126	1983	25	33.42.85.20.126	33.42.85.20.146
	3967	50	33.42.85.20.136	33.42.85.20.156
1407	2480	31	33.42.85.20.127	33.42.85.20.147
	4959	63	33.42.85.20.137	33.42.85.20.157
2250	3967	50	33.42.85.20.128	33.42.85.20.148
	7934	101	33.42.85.20.138	33.42.85.20.158
2812	4959	63	33.42.85.20.129	33.42.85.20.149
	9917	126	33.42.85.20.139	33.42.85.20.159
Corner 625x625	1983	25	33.42.85.20.520	33.42.85.20.528
	3967	50	33.42.85.20.521	33.42.85.20.529

Micro Prismatic Diffuser - UGR<19

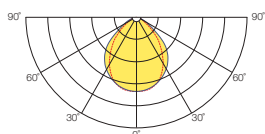

# OMEGA XS

## RECESSED

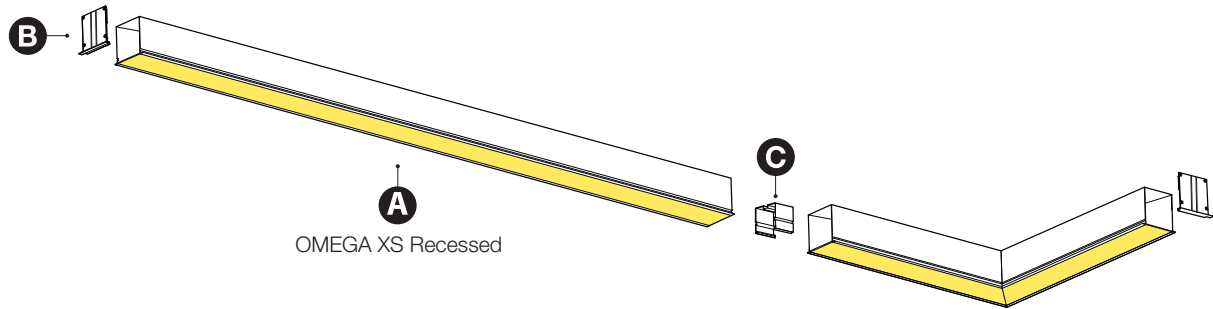

### COMPONENTS



#### **B** END CAP (1pc)

	<b>COD</b>
Matt White	35.42.85.20.001
Matt Anodized Similar Painting	35.42.85.20.002



#### **C** LINEAR COUPLER (2pcs)

	<b>COD</b>
Coupler	35.42.85.00.000

### OPTIONS



#### **EMERGENCY (EM) - SELF-TEST INTEGRATED**

<b>ON/OFF</b>	<b>COD</b>
EM 1H 3W	35.00.003.01.23*
EM 3H 3W	35.00.003.01.24**
<b>DALI</b>	<b>COD</b>
EM 1H 5,4W DALI	35.00.004.01.54*
EM 3H 5,4W DALI	35.00.004.01.55**

\* Applies to lengths equal to or greater than 1126 mm. \*\* Applies to lengths equal to or greater than 1407 mm.  
 > On request – External Emergency. Box dimensions: 45x120x360 mm.

# OMEGA XS

## TRIMLESS



OPAL or  
MICRO PRISMATIC

### PT

- > Sistema modular de iluminação para aplicação encastrada sem aba de remate (trimless).
- > Pode ser usado como luminária individual, sistema em linha contínua ou formas geométricas.
- > Cantos iluminados que permitem luz uniforme sem interrupções em linhas contínuas com mudanças de direção a 90°.
- > Difusor Policarbonato Microprismático para controlo do encandeamento (UGR <19) ou difusor Policarbonato Opal.
- > Corpo em perfil de alumínio extrudido.

### ES

- > Sistema modular de iluminación para instalación empotrada sin marco de remate (trimless).
- > Se puede usar como luminaria individual, sistema en línea continua o formas geométricas.
- > Esquinas iluminadas aseguran luz uniforme sin interrupciones en las líneas continuas con cambios de dirección de 90°.
- > Difusor Policarbonato Microprismático para control del deslumbramiento (UGR <19) o difusor Policarbonato Opal.
- > Cuerpo en perfil de aluminio extruido.

**QUICK INFO**

**GENERAL**

Trimless  
 IP43 (Optic)  
 IP20  
 IK05  
 850°C  
 Class I  
 Ta= -20°C +35°C

**OPTIC**

Opal Polycarbonate

**LED**

Efficacy up to 171 lm/W  
 3000 K, 4000 K  
 CRI >80  
 Lifetime 72 000 H  
 L80/B10 @Tc=65°C

**ELETRICAL SYSTEM**

230V/50Hz  
 ON/OFF, DALI

**FINISHING**

RAL 9003 Matt White

**OPTIONS**

**GENERAL** (Individual Luminaire)

IP44 (Optic)  
 Class II

**LED**

2700 K, 5000 K, 6500 K  
 Tunable White, RGB, RGBW  
 CRI >90

**ELECTRICAL SYSTEM**

DSI, DIM 1-10V, Phase-cut

**CONTROL SYSTEM**

Bluetooth

**EMERGENCY**

1 Hour, 3 Hours  
 DALI 1 Hour, 3 Hours

**SENSORS**

Motion  
 Ambient Light  
 Motion & Ambient Light

**OMEGA XS TRIMLESS**

**OPAL DIFFUSER**

c (mm)	Output (lm)	System (W)	ON/OFF	DALI
<b>3000 K</b>				
845	1888	19	33.42.85.30.000	33.42.85.30.010
	3776	38	33.42.85.30.005	33.42.85.30.015
1126	2517	25	33.42.85.30.001	33.42.85.30.011
	5035	50	33.42.85.30.006	33.42.85.30.016
1407	3146	31	33.42.85.30.002	33.42.85.30.012
	6293	63	33.42.85.30.007	33.42.85.30.017
2250	5034	50	33.42.85.30.003	33.42.85.30.013
	10070	101	33.42.85.30.008	33.42.85.30.018
2812	6293	63	33.42.85.30.004	33.42.85.30.014
	12587	126	33.42.85.30.009	33.42.85.30.019
Corner 625x625	2517	25	33.42.85.30.500	33.42.85.30.504
	5035	50	33.42.85.30.501	33.42.85.30.505
<b>4000 K</b>				
845	1976	19	33.42.85.30.020	33.42.85.30.030
	3951	38	33.42.85.30.025	33.42.85.30.035
1126	2634	25	33.42.85.30.021	33.42.85.30.031
	5268	50	33.42.85.30.026	33.42.85.30.036
1407	3293	31	33.42.85.30.022	33.42.85.30.032
	6585	63	33.42.85.30.027	33.42.85.30.037
2250	5268	50	33.42.85.30.023	33.42.85.30.033
	10536	101	33.42.85.30.028	33.42.85.30.038
2812	6586	63	33.42.85.30.024	33.42.85.30.034
	13170	126	33.42.85.30.029	33.42.85.30.039
Corner 625x625	2634	25	33.42.85.30.508	33.42.85.30.512
	5268	50	33.42.85.30.509	33.42.85.30.513

**ON REQUEST (INDIVIDUAL LUMINAIRE)**

- > IP44 (OPTIC);
- > CLASS II.

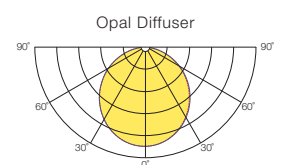
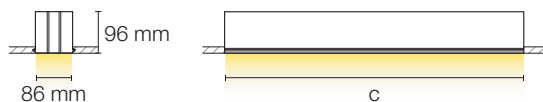

**QUICK INFO**

**GENERAL**

Trimless  
 IP43 (Optic)  
 IP20  
 IK08  
 850°C  
 Class I  
 Ta= -20°C +35°C

**OPTIC**

Micro Prismatic Polycarbonate  
 UGR <19

**LED**

Efficacy up to 171 lm/W  
 3000 K, 4000 K  
 CRI >80  
 Lifetime 72 000 H  
 L80/B10 @TC=65°C

**ELETRICAL SYSTEM**

230V/50Hz  
 ON/OFF, DALI

**FINISHING**

RAL 9003 Matt White

**OPTIONS**

**GENERAL** (Individual Luminaire)

IP44 (Optic)  
 Class II

**LED**

2700 K, 5000 K, 6500 K  
 Tunable White, RGB, RGBW  
 CRI >90

**ELECTRICAL SYSTEM**

DSI, DIM 1-10V, Phase-cut

**CONTROL SYSTEM**

Bluetooth

**EMERGENCY**

1 Hour, 3 Hours  
 DALI 1 Hour, 3 Hours

**SENSORS**

Motion  
 Ambient Light  
 Motion & Ambient Light

Micro Prismatic Diffuser - UGR<19

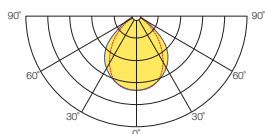

**OMEGA XS TRIMLESS**

**MICRO PRISMATIC DIFFUSER - UGR <19**

c (mm)	Output (lm)	System (W)	ON/OFF	DALI
<b>3000 K</b>				
845	1422	19	33.42.85.30.040	33.42.85.30.050
	2843	38	33.42.85.30.045	33.42.85.30.055
1126	1895	25	33.42.85.30.041	33.42.85.30.051
	3791	50	33.42.85.30.046	33.42.85.30.056
1407	2369	31	33.42.85.30.042	33.42.85.30.052
	4739	63	33.42.85.30.047	33.42.85.30.057
2250	3790	50	33.42.85.30.043	33.42.85.30.053
	7583	101	33.42.85.30.048	33.42.85.30.058
2812	4739	63	33.42.85.30.044	33.42.85.30.054
	9478	126	33.42.85.30.049	33.42.85.30.059
Corner 625x625	1895	25	33.42.85.30.502	33.42.85.30.506
	3791	50	33.42.85.30.503	33.42.85.30.507
<b>4000 K</b>				
845	1488	19	33.42.85.30.060	33.42.85.30.070
	2975	38	33.42.85.30.065	33.42.85.30.075
1126	1983	25	33.42.85.30.061	33.42.85.30.071
	3967	50	33.42.85.30.066	33.42.85.30.076
1407	2480	31	33.42.85.30.062	33.42.85.30.072
	4959	63	33.42.85.30.067	33.42.85.30.077
2250	3967	50	33.42.85.30.063	33.42.85.30.073
	7934	101	33.42.85.30.068	33.42.85.30.078
2812	4959	63	33.42.85.30.064	33.42.85.30.074
	9917	126	33.42.85.30.069	33.42.85.30.079
Corner 625x625	1983	25	33.42.85.30.510	33.42.85.30.514
	3967	50	33.42.85.30.511	33.42.85.30.515

**DESCRIPTION**

- 1 > DRIVER
- 2 > LED BOARD
- 3 > LED COVER
- 4 > REFLECTOR
- 5 > DIFFUSER

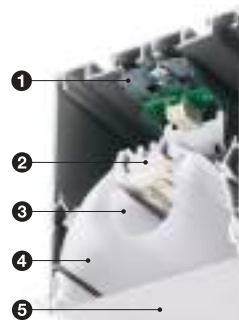



# OMEGA XS

## TRIMLESS

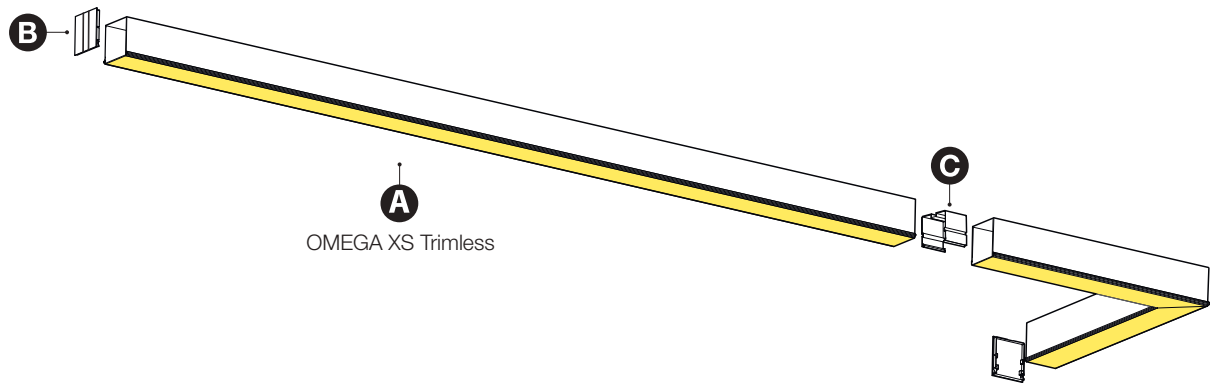

### COMPONENTS



**B END CAP (1pc)**

Matt White

**COD**

35.42.85.00.001



**C LINEAR COUPLER (1pc)**

Coupler

**COD**

35.42.85.00.000

### OPTIONS



**EMERGENCY (EM) - SELF-TEST INTEGRATED**

**ON/OFF**

**COD**

EM 1H 3W

35.00.003.01.23\*

EM 3H 3W

35.00.003.01.24\*\*

**DALI**

**COD**

EM 1H 5,4W DALI

35.00.004.01.54\*

EM 3H 5,4W DALI

35.00.004.01.55\*\*

\* Applies to lengths equal to or greater than 1126 mm. \*\* Applies to lengths equal to or greater than 1407 mm.  
 > On request - External Emergency. Box dimensions: 45x120x360 mm.

**OMEGA**  
RECESSED





# OMEGA DIRECT LIGHT RECESSED

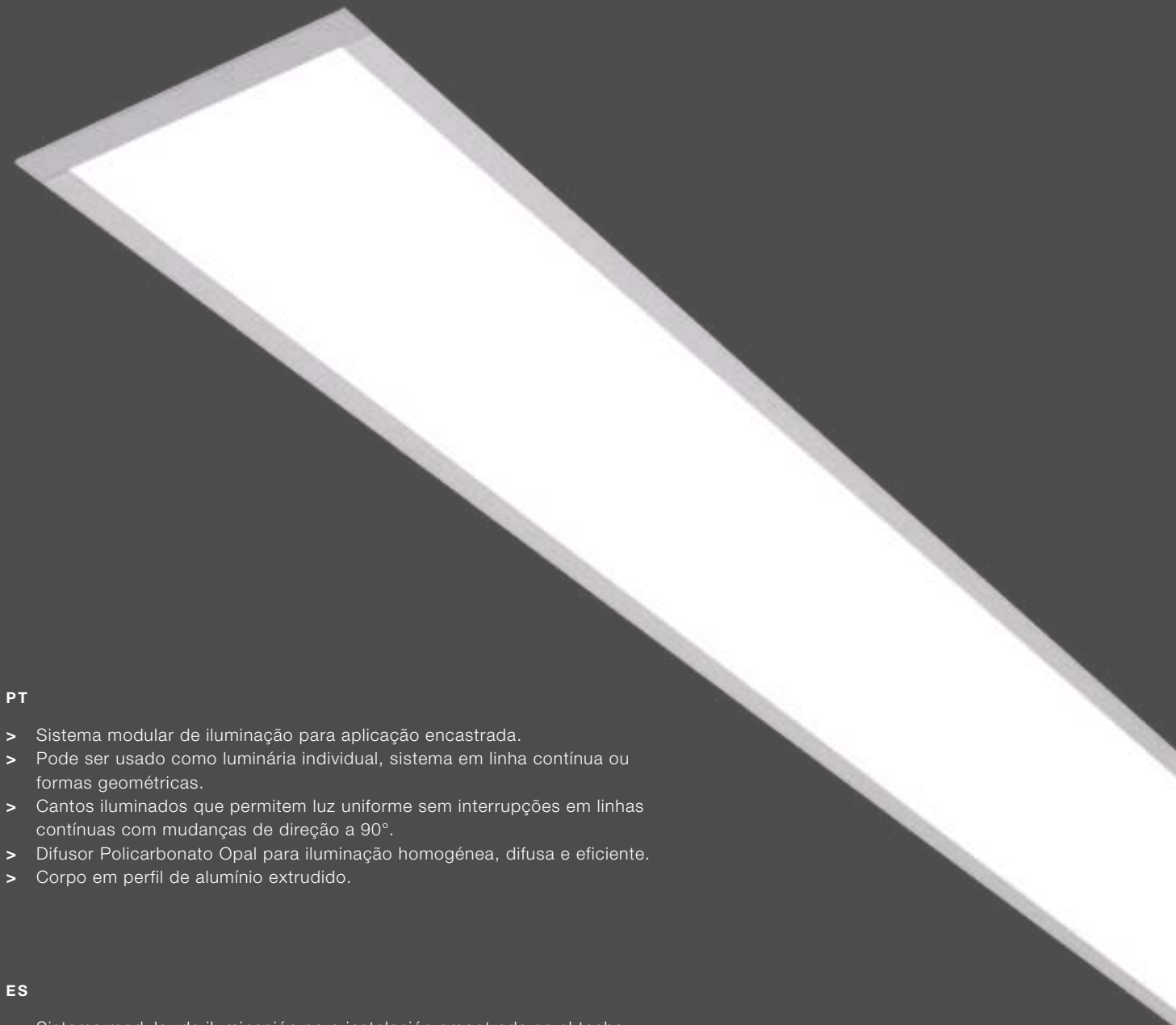

## PT

- > Sistema modular de iluminação para aplicação encastrada.
- > Pode ser usado como luminária individual, sistema em linha contínua ou formas geométricas.
- > Cantos iluminados que permitem luz uniforme sem interrupções em linhas contínuas com mudanças de direção a 90°.
- > Difusor Policarbonato Opal para iluminação homogénea, difusa e eficiente.
- > Corpo em perfil de alumínio extrudido.

## ES

- > Sistema modular de iluminación para instalación empotrada en el techo.
- > Se puede usar como luminaria individual, sistema en línea continua o formas geométricas.
- > Esquinas iluminadas aseguran luz uniforme sin interrupciones en las líneas continuas con cambios de dirección de 90°.
- > Difusor Policarbonato Opal.
- > Cuerpo en perfil de aluminio extruido.

**QUICK INFO**

**GENERAL**

Recessed  
 IP43 (Optic)  
 IP20  
 IK05  
 850°C  
 Class I  
 Ta= -20°C +35°C

**OPTIC**

Opal Polycarbonate

**LED**

Efficacy up to 179 lm/W  
 3000 K, 4000 K  
 CRI >80  
 Lifetime 72 000 H  
 L80/B10 @Tc=65°C

**ELETRICAL SYSTEM**

230V/50Hz  
 ON/OFF, DALI

**FINISHING**

RAL 9003 Matt White  
 Matt Anodized

**OPTIONS**

**GENERAL** (Individual Luminaire)

IP44 (Optic)  
 Class II

**LED**

2700 K, 5000 K, 6500 K  
 Tunable White, RGB, RGBW  
 CRI >90

**ELECTRICAL SYSTEM**

DSI, DIM 1-10V, Phase-cut

**CONTROL SYSTEM**

Bluetooth

**FINISHING**

 Other Colours

**EMERGENCY**

1 Hour, 3 Hours  
 DALI 1 Hour, 3 Hours

**SENSORS**

Motion  
 Ambient Light  
 Motion & Ambient Light

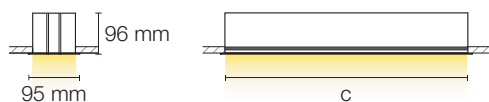

**OMEGA RECESSED**

**OPAL DIFFUSER**

**MATT WHITE FINISHING**

c (mm)	Output (lm)	System (W)	ON/OFF	DALI
<b>3000 K</b>				
856	3503	39	33.42.95.20.000	33.42.95.20.010
1137	4669	52	33.42.95.20.001	33.42.95.20.011
1418	5837	64	33.42.95.20.002	33.42.95.20.012
2261	9339	103	33.42.95.20.003	33.42.95.20.013
2823	11675	129	33.42.95.20.004	33.42.95.20.014
Corner 632x632	4669	52	33.42.95.20.501	33.42.95.20.503
<b>4000 K</b>				
856	3666	39	33.42.95.20.020	33.42.95.20.030
1137	4888	52	33.42.95.20.021	33.42.95.20.031
1418	6110	64	33.42.95.20.022	33.42.95.20.032
2261	9776	103	33.42.95.20.023	33.42.95.20.033
2823	12219	129	33.42.95.20.024	33.42.95.20.034
Corner 632x632	4888	52	33.42.95.20.505	33.42.95.20.507

**MATT ANODIZED FINISHING**

c (mm)	Output (lm)	System (W)	ON/OFF	DALI
<b>3000 K</b>				
856	3503	39	33.42.95.20.005	33.42.95.20.015
1137	4669	52	33.42.95.20.006	33.42.95.20.016
1418	5837	64	33.42.95.20.007	33.42.95.20.017
2261	9339	103	33.42.95.20.008	33.42.95.20.018
2823	11675	129	33.42.95.20.009	33.42.95.20.019
Corner 632x632	4669	52	33.42.95.20.500	33.42.95.20.502
<b>4000 K</b>				
856	3666	39	33.42.95.20.025	33.42.95.20.035
1137	4888	52	33.42.95.20.026	33.42.95.20.036
1418	6110	64	33.42.95.20.027	33.42.95.20.037
2261	9776	103	33.42.95.20.028	33.42.95.20.038
2823	12219	129	33.42.95.20.029	33.42.95.20.039
Corner 632x632	4888	52	33.42.95.20.504	33.42.95.20.506

**ON REQUEST (INDIVIDUAL LUMINAIRE)**

- > IP44 (OPTIC);
- > CLASS II.

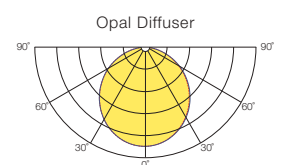

# OMEGA RECESSED

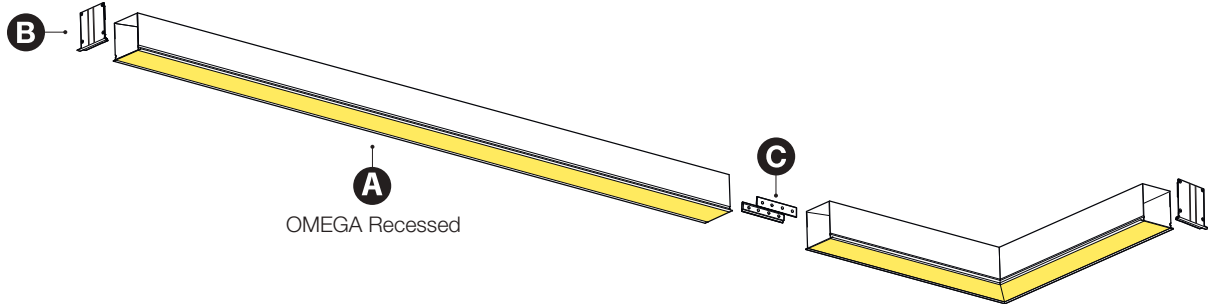

## COMPONENTS



### **B** END CAP (1pc)

**COD**

Matt White

35.42.95.20.000

Matt Anodized Similar Painting

35.42.95.20.001



### **C** LINEAR COUPLER (2pcs)

**COD**

Coupler

35.42.85.20.000

## OPTIONS



### **EMERGENCY (EM) - SELF-TEST INTEGRATED**

#### **ON/OFF**

**COD**

EM 1H 3W

35.00.003.01.23\*

EM 3H 3W

35.00.003.01.24\*\*

#### **DALI**

**COD**

EM 1H 5,4W DALI

35.00.004.01.54\*

EM 3H 5,4W DALI

35.00.004.01.55\*\*

\* Applies to lengths equal to or greater than 1418 mm. \*\* Applies to lengths equal to or greater than 2823 mm.  
> On request – External Emergency. Box dimensions: 45x120x360 mm.

## DESCRIPTION

- 1 > DRIVER
- 2 > LED BOARD
- 3 > REFLECTOR
- 4 > DIFFUSER

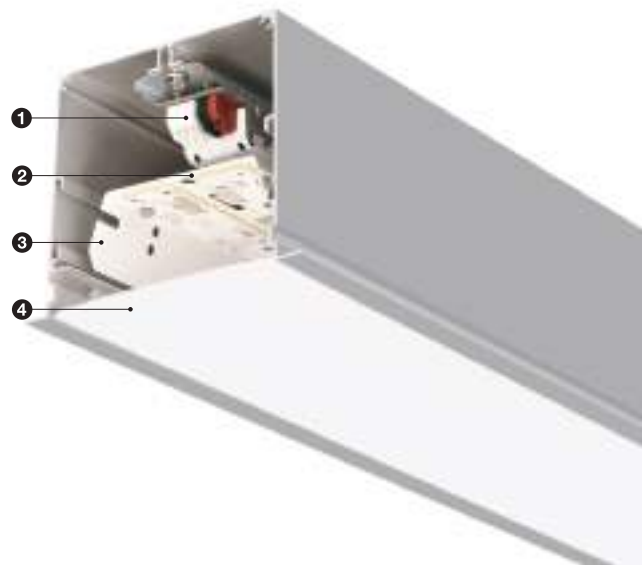



**CARDAN**  
SUSPENDED







> **CARDAN SUSPENDED** - BESPOKE SOLUTION

# CARDAN

## SUSPENDED



### PT

- > Luminária composta por focos orientáveis em dois eixos.
- > Mecanismo articulado que permite a inclinação até 30° em dois eixos.
- > Ideal para iluminação geral e de destaque em interiores.
- > De aplicação suspensa por cabos de aço inox com ajuste rápido da altura.
- > Refletor facetado com três opções de ângulo de abertura do feixe: 14°, 24° ou 34°.
- > Corpo em alumínio com acabamento anodizado mate.

### ES

- > Luminaria compuesta por proyectores orientables en dos ejes.
- > Mecanismo de giro que permite la inclinación hasta 30° en dos ejes.
- > Ideal para la iluminación general e de acento en interiores.
- > De aplicación suspendida por cables de acero inoxidable con regulación de la altura.
- > Reflector facetado con tres opciones de ángulo de emisión: 14°, 24° o 34°.
- > Cuerpo en aluminio con acabado anodizado mate.

**QUICK INFO**

**GENERAL**

Suspended  
 IP20  
 650°C  
 Class I  
 Ta= -20°C +35°C

**LED**

Efficacy up to 147 lm/W  
 3000 K, 4000 K  
 CRI >85  
 Lifetime 50 000 H  
 L90/B10 @TC=85°C

**ELECTRICAL SYSTEM**

230V/50Hz  
 ON/OFF, DALI

**FINISHING**

Matt Anodized

**OPTIONS**

**LED**

2700 K  
 CRI >90

**ELECTRICAL SYSTEM**

DSI, DIM 1-10V, Phase-cut

**CONTROL SYSTEM**

Bluetooth

**FINISHING**

Other Colours

**EMERGENCY**

1 Hour, 3 Hours  
 DALI 1 Hour, 3 Hours

**SENSORS**

Motion  
 Ambient Light  
 Motion & Ambient Light

**CARDAN DUO SUSPENDED**

**MATT ANODIZED FINISHING**

Beam Angle (°)	Output (lm)	System (W)	ON/OFF	DALI
<b>3000 K</b>				
14°	3168	27	33.92.003.08.90	33.92.004.08.03
	4386	40	33.92.003.08.93	33.92.004.08.12
24°	3163	27	33.92.003.08.91	33.92.004.08.04
	4379	40	33.92.004.08.01	33.92.004.08.13
34°	3169	27	33.92.003.08.92	33.92.004.08.05
	4381	40	33.92.004.08.02	33.92.004.08.14
<b>4000 K</b>				
14°	3273	27	33.92.004.08.15	33.92.004.08.29
	4528	40	33.92.004.08.26	33.92.004.08.38
24°	3268	27	33.92.004.08.16	33.92.004.08.36
	4522	40	33.92.004.08.27	33.92.004.08.39
34°	3271	27	33.92.004.08.17	33.92.004.08.37
	4532	40	33.92.004.08.28	33.92.004.08.40

**CARDAN TETRA SUSPENDED**

**MATT ANODIZED FINISHING**

Beam Angle (°)	Output (lm)	System (W)	ON/OFF	DALI
<b>3000 K</b>				
14°	6257	53	33.92.004.08.41	33.92.004.08.56
	8662	80	33.92.004.08.48	33.92.004.08.67
24°	6301	53	33.92.004.08.46	33.92.004.08.57
	8723	80	33.92.004.08.49	33.92.004.08.72
34°	6269	53	33.92.004.08.47	33.92.004.08.64
	8668	80	33.92.004.08.55	33.92.004.08.73
<b>4000 K</b>				
14°	6464	53	33.92.004.08.74	33.92.009.08.01
	8944	80	33.92.008.08.98	33.92.009.08.04
24°	6509	53	33.92.004.08.75	33.92.009.08.02
	9007	80	33.92.008.08.99	33.92.009.08.05
34°	6473	53	33.92.008.08.97	33.92.009.08.03
	8966	80	33.92.009.08.00	33.92.009.08.06

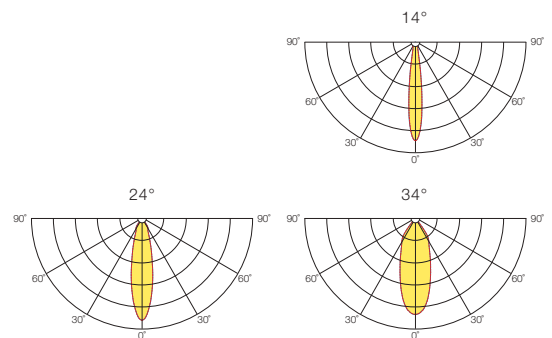
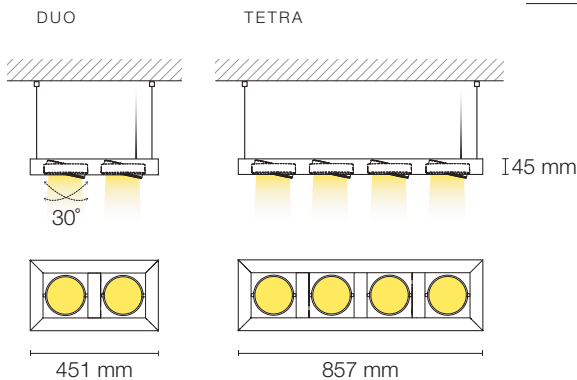

# CARDAN

## SUSPENDED

### COMPONENTS



#### SUSPENSION SYSTEM (4pcs)

TYPE	1 m	3 m	5 m
Matt White + Stainless Steel Cable	35.92.003.01.64	35.92.003.01.65	35.92.003.01.66



#### SURFACE CEILING CUP (1pc)

MATT WHITE	DIMENSION	1 m	3 m	5 m
ON/OFF	Ø62x36 mm	35.42.001.01.80	35.42.001.01.88	35.42.001.01.96
DALI	Ø103x36 mm	35.42.001.01.82	35.42.001.01.90	35.42.001.01.98



#### RECESSED CEILING CUP (1pc)

MATT WHITE	DIMENSION	1 m	3 m	5 m
ON/OFF	Ø80 mm	35.42.001.01.84	35.42.001.01.92	35.42.002.01.00
DALI	Ø80 mm	35.42.001.01.86	35.42.001.01.94	35.42.002.01.02



# CARDAN SURFACE



## PT

- > Luminária de aplicação saliente composta por focos orientáveis em dois eixos.
- > Mecanismo articulado que permite a inclinação até 30° em dois eixos.
- > Refletor facetado com três opções de ângulo de abertura do feixe: 14°, 24° ou 34°.
- > Corpo em chapa de alumínio com 4 mm de espessura e acabamento cinza, com caixa interior em branco ou preto.

## ES

- > Luminaria para instalación en superficie compuesta por proyectores orientables en dos ejes.
- > Mecanismo de giro que permite la inclinación hasta 30° en dos ejes.
- > Reflector facetado con tres opciones de ángulo de emisión: 14°, 24° o 34°.
- > Cuerpo en chapa de aluminio de 4 mm de espesor en gris y caja interior con acabado blanco o negro.

CARDAN SURFACE SINGLE

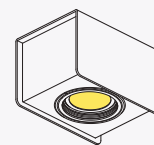

CARDAN SURFACE DUO

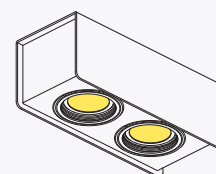

**QUICK INFO**

**GENERAL**

Surface  
 IP20  
 650°C  
 Class I  
 Ta= -20°C +35°C

**LED**

Efficacy up to 147 lm/W  
 3000 K, 4000 K  
 CRI >85  
 Lifetime 50 000 H  
 L90/B10 @TC=85°C

**ELECTRICAL SYSTEM**

230V/50Hz  
 ON/OFF, DALI

**FINISHING**

Outer Housing  
 RAL 9006 Grey  
 Inner Housing  
 RAL 9003 Matt White  
 RAL 9005 Matt Black

**OPTIONS**

**LED**

2700 K  
 CRI >90

**ELECTRICAL SYSTEM**

DSI, DIM 1-10V, Phase-cut

**CONTROL SYSTEM**

Bluetooth

**FINISHING**

 Other Colours

**EMERGENCY**

1 Hour, 3 Hours  
 DALI 1 Hour, 3 Hours

**SENSORS**

Motion  
 Ambient Light  
 Motion & Ambient Light

**CARDAN DUO SURFACE**

**MATT WHITE FINISHING**

Beam Angle (°)	Output (lm)	System (W)	ON/OFF	DALI
<b>3000 K</b>				
14°	3159	27	33.92.010.08.24	33.92.010.08.36
	4374	40	33.92.010.08.27	33.92.010.08.39
24°	3147	27	33.92.010.08.25	33.92.010.08.37
	4356	40	33.92.010.08.28	33.92.010.08.40
34°	3112	27	33.92.010.08.26	33.92.010.08.38
	4304	40	33.92.010.08.29	33.92.010.08.41
<b>4000 K</b>				
14°	3264	27	33.92.010.08.48	33.92.010.08.60
	4516	40	33.92.010.08.51	33.92.010.08.63
24°	3250	27	33.92.010.08.49	33.92.010.08.61
	4498	40	33.92.010.08.52	33.92.010.08.64
34°	3214	27	33.92.010.08.50	33.92.010.08.62
	4451	40	33.92.010.08.53	33.92.010.08.65

**MATT BLACK FINISHING**

Beam Angle (°)	Output (lm)	System (W)	ON/OFF	DALI
<b>3000 K</b>				
14°	3159	27	33.92.010.08.30	33.92.010.08.42
	4374	40	33.92.010.08.33	33.92.010.08.45
24°	3147	27	33.92.010.08.31	33.92.010.08.43
	4356	40	33.92.010.08.34	33.92.010.08.46
34°	3112	27	33.92.010.08.32	33.92.010.08.44
	4304	40	33.92.010.08.35	33.92.010.08.47
<b>4000 K</b>				
14°	3264	27	33.92.010.08.54	33.92.010.08.66
	4516	40	33.92.010.08.57	33.92.010.08.69
24°	3250	27	33.92.010.08.55	33.92.010.08.67
	4498	40	33.92.010.08.58	33.92.010.08.70
34°	3214	27	33.92.010.08.56	33.92.010.08.68
	4451	40	33.92.010.08.59	33.92.010.08.71

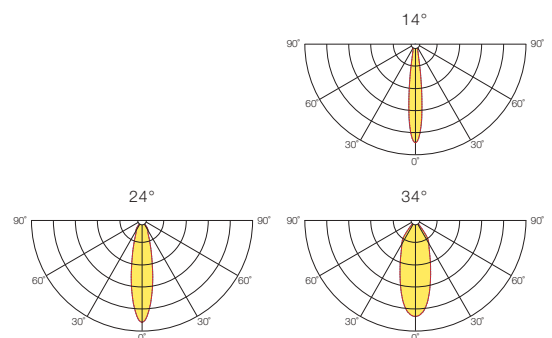
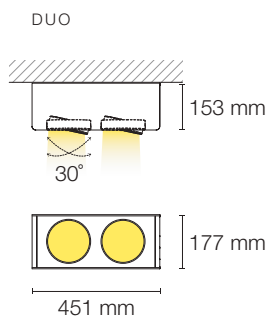

**QUICK INFO**

**GENERAL**

Surface  
 IP20  
 650°C  
 Class I  
 Ta= -20°C +35°C

**LED**

Efficacy up to 147 lm/W  
 3000 K, 4000 K  
 CRI >85  
 Lifetime 50 000 H  
 L90/B10 @TC=85°C

**ELETRICAL SYSTEM**

230V/50Hz  
 ON/OFF

**FINISHING**

Outer Housing  
 RAL 9006 Grey  
 Inner Housing  
 RAL 9003 Matt White  
 RAL 9005 Matt Black

**OPTIONS**

**LED**

2700 K  
 CRI >90

**ELECTRICAL SYSTEM**

DALI, DSI, DIM 1-10V, Phase-cut

**CONTROL SYSTEM**

Bluetooth

**FINISHING**

 Other Colours

**EMERGENCY**

1 Hour, 3 Hours  
 DALI 1 Hour, 3 Hours

**SENSORS**

Motion  
 Ambient Light  
 Motion & Ambient Light

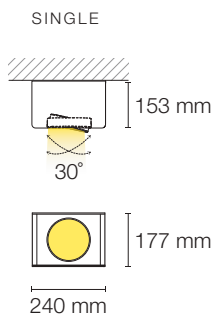

**CARDAN SINGLE SURFACE**

**MATT WHITE FINISHING**

Beam Angle (°)	Output (lm)	System (W)	ON/OFF
<b>3000 K</b>			
14°	1460	13	33.92.010.08.00
	2021	20	33.92.010.08.03
24°	1478	13	33.92.010.08.01
	2046	20	33.92.010.08.04
34°	1471	13	33.92.010.08.02
	2034	20	33.92.010.08.05
<b>4000 K</b>			
14°	1508	13	33.92.010.08.12
	2086	20	33.92.010.08.15
24°	1527	13	33.92.010.08.13
	2112	20	33.92.010.08.16
34°	1519	13	33.92.010.08.14
	2103	20	33.92.010.08.17

**MATT BLACK FINISHING**

Beam Angle (°)	Output (lm)	System (W)	ON/OFF
<b>3000 K</b>			
14°	1460	13	33.92.010.08.06
	2021	20	33.92.010.08.09
24°	1478	13	33.92.010.08.07
	2046	20	33.92.010.08.10
34°	1471	13	33.92.010.08.08
	2034	20	33.92.010.08.11
<b>4000 K</b>			
14°	1508	13	33.92.010.08.18
	2086	20	33.92.010.08.21
24°	1527	13	33.92.010.08.19
	2112	20	33.92.010.08.22
34°	1519	13	33.92.010.08.20
	2103	20	33.92.010.08.23

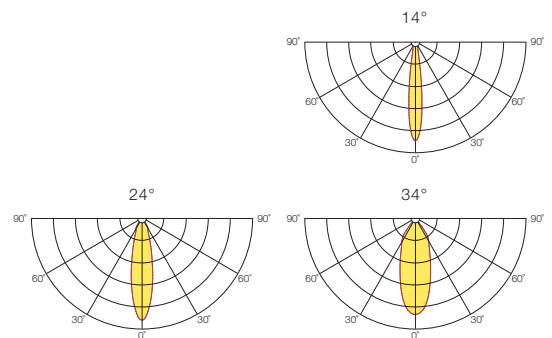





# CARDAN

## RECESSED



### PT

- > Luminária para aplicação encastrada composta por focos LED orientáveis em dois eixos.
- > Em versões Single e Duo ideais para iluminação geral e de destaque em interiores.
- > Mecanismo articulado que permite a inclinação até 30° em dois eixos.
- > Refletor facetado com três opções de ângulo de abertura do feixe: 14°, 24° ou 34°.
- > Corpo e moldura lacados a epoxy-poliéster.

### ES

- > Luminaria para instalación empotrada en el techo compuesta por proyectores LED orientables en dos ejes.
- > En versiones Single y Duo ideales para la iluminación general e de acento en interiores.
- > Mecanismo de giro que permite la inclinación hasta 30° en dos ejes.
- > Reflector facetado con tres opciones de ángulo de emisión: 14°, 24° o 34°.
- > Cuerpo y marco con recubrimiento epoxi-poliéster.

CARDAN RECESSED SINGLE

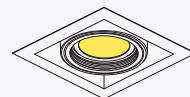

CARDAN RECESSED DUO

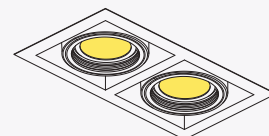

**QUICK INFO**

**GENERAL**

Recessed  
 IP20  
 650°C  
 Class I  
 Ta= -20°C +35°C

**LED**

Efficacy up to 147 lm/W  
 3000 K, 4000 K  
 CRI >85  
 Lifetime 50 000 H  
 L90/B10 @TC=85°C

**ELECTRICAL SYSTEM**

230V/50Hz  
 ON/OFF, DALI

**FINISHING**

RAL 9003 Matt White  
 RAL 9005 Matt Black

**OPTIONS**

**LED**

2700 K  
 Tunable White, RGB, RGBW  
 CRI >90

**ELECTRICAL SYSTEM**

DSI, DIM 1-10V, Phase-cut

**CONTROL SYSTEM**

Bluetooth

**FINISHING**

 Other Colours

**EMERGENCY**

1 Hour, 3 Hours  
 DALI 1 Hour, 3 Hours

**SENSORS**

Motion  
 Ambient Light  
 Motion & Ambient Light

**CARDAN DUO RECESSED**

**MATT WHITE FINISHING**

Beam Angle (°)	Output (lm)	System (W)	ON/OFF	DALI
<b>3000 K</b>				
14°	3184	27	33.92.008.08.48	33.92.008.08.60
	4408	40	33.92.008.08.51	33.92.008.08.63
24°	3165	27	33.92.008.08.49	33.92.008.08.61
	4382	40	33.92.008.08.52	33.92.008.08.64
34°	3156	27	33.92.008.08.50	33.92.008.08.62
	4365	40	33.92.008.08.53	33.92.008.08.65
<b>4000 K</b>				
14°	3289	27	33.92.008.08.72	33.92.008.08.84
	4552	40	33.92.008.08.75	33.92.008.08.87
24°	3270	27	33.92.008.08.73	33.92.008.08.85
	4524	40	33.92.008.08.76	33.92.008.08.88
34°	3259	27	33.92.008.08.74	33.92.008.08.86
	4515	40	33.92.008.08.77	33.92.008.08.89

**MATT BLACK FINISHING**

Beam Angle (°)	Output (lm)	System (W)	ON/OFF	DALI
<b>3000 K</b>				
14°	3184	27	33.92.008.08.54	33.92.008.08.66
	4408	40	33.92.008.08.57	33.92.008.08.69
24°	3165	27	33.92.008.08.55	33.92.008.08.67
	4382	40	33.92.008.08.58	33.92.008.08.70
34°	3156	27	33.92.008.08.56	33.92.008.08.68
	4365	40	33.92.008.08.59	33.92.008.08.71
<b>4000 K</b>				
14°	3289	27	33.92.008.08.78	33.92.008.08.90
	4552	40	33.92.008.08.81	33.92.008.08.93
24°	3270	27	33.92.008.08.79	33.92.008.08.91
	4524	40	33.92.008.08.82	33.92.008.08.94
34°	3259	27	33.92.008.08.80	33.92.008.08.92
	4515	40	33.92.008.08.83	33.92.008.08.95

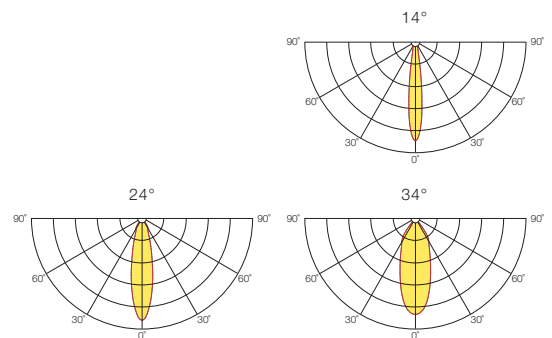
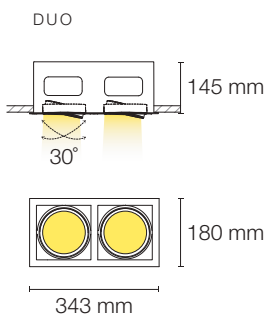

**QUICK INFO**

**GENERAL**

Recessed  
 IP20  
 650°C  
 Class I  
 Ta= -20°C +35°C

**LED**

Efficacy up to 147 lm/W  
 3000 K, 4000 K  
 CRI >85  
 Lifetime 50 000 H  
 L90/B10 @TC=85°C

**ELECTRICAL SYSTEM**

230V/50Hz  
 ON/OFF, DALI

**FINISHING**

RAL 9003 Matt White  
 RAL 9005 Matt Black

**OPTIONS**

**LED**

2700 K  
 CRI >90

**ELECTRICAL SYSTEM**

DSI, DIM 1-10V, Phase-cut

**CONTROL SYSTEM**

Bluetooth

**FINISHING**

 Other Colours

**EMERGENCY**

1 Hour, 3 Hours  
 DALI 1 Hour, 3 Hours

**SENSORS**

Motion  
 Ambient Light  
 Motion & Ambient Light

**CARDAN SINGLE RECESSED**

**MATT WHITE FINISHING**

Beam Angle (°)	Output (lm)	System (W)	ON/OFF	DALI
<b>3000 K</b>				
14°	1460	13	33.92.008.08.00	33.92.008.08.12
	2021	20	33.92.008.08.03	33.92.008.08.15
24°	1478	13	33.92.008.08.01	33.92.008.08.13
	2046	20	33.92.008.08.04	33.92.008.08.16
34°	1471	13	33.92.008.08.02	33.92.008.08.14
	2034	20	33.92.008.08.05	33.92.008.08.17
<b>4000 K</b>				
14°	1508	13	33.92.008.08.24	33.92.008.08.36
	2086	20	33.92.008.08.27	33.92.008.08.39
24°	1527	13	33.92.008.08.25	33.92.008.08.37
	2112	20	33.92.008.08.28	33.92.008.08.40
34°	1519	13	33.92.008.08.26	33.92.008.08.38
	2103	20	33.92.008.08.29	33.92.008.08.41

**MATT BLACK FINISHING**

Beam Angle (°)	Output (lm)	System (W)	ON/OFF	DALI
<b>3000 K</b>				
14°	1460	13	33.92.008.08.06	33.92.008.08.18
	2021	20	33.92.008.08.09	33.92.008.08.21
24°	1478	13	33.92.008.08.07	33.92.008.08.19
	2046	20	33.92.008.08.10	33.92.008.08.22
34°	1471	13	33.92.008.08.08	33.92.008.08.20
	2034	20	33.92.008.08.11	33.92.008.08.23
<b>4000 K</b>				
14°	1508	13	33.92.008.08.30	33.92.008.08.42
	2086	20	33.92.008.08.33	33.92.008.08.45
24°	1527	13	33.92.008.08.31	33.92.008.08.43
	2112	20	33.92.008.08.34	33.92.008.08.46
34°	1519	13	33.92.008.08.32	33.92.008.08.44
	2103	20	33.92.008.08.35	33.92.008.08.47

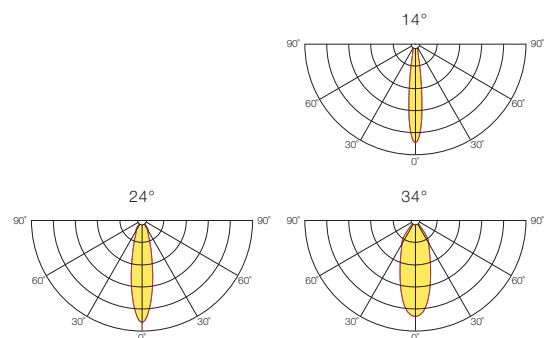
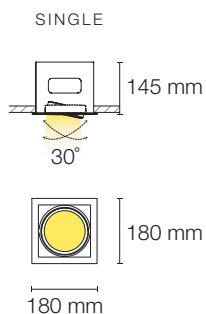



**ERUS**  
SUSPENDED





> ERUS 90 SUSPENDED

# ERUS 25 SUSPENDED



## PT

- > Luminária LED de aplicação suspenso.
- > Formato tubular diâmetro 25 mm com diversos comprimentos disponíveis.
- > Pode ser usada como luminária individual ou em grupos de luminárias alimentadas por um único Driver.
- > A ótica com lente integrada permite ângulos de abertura de 30° ou 45°.
- > Driver externo de corrente constante e classe proteção II.
- > Tubo em alumínio com revestimento a epoxy-poliéster.

## ES

- > Luminaria LED para aplicación suspendida.
- > Formato tubular diámetro 25 mm disponible en varias longitudes.
- > Se puede usar como luminaria individual o en grupos de luminarias utilizando un solo Driver.
- > La óptica con lente integrada permite ángulos de apertura de 30° o 45°.
- > Driver externo de corriente constante y clase de protección II.
- > Tubo en aluminio con recubrimiento epoxi-poliéster.



**QUICK INFO**

**GENERAL**

Suspended  
IP20  
650°C  
Class III  
Ta= -20°C +35°C

**OPTIC**

PMMA Lens

**LED**

Efficacy up to 129 lm/W  
2700 K, 3000 K, 4000 K  
CRI >90  
Lifetime 65 000 H  
L80/B10 @Tc=75°C

**ELETRICAL SYSTEM**

230V/50Hz  
ON/OFF, DALI

**FINISHING**

RAL 9003 Matt White  
RAL 9005 Matt Black

**OPTIONS**

**LED**

5000 K, 6500 K

**ELECTRICAL SYSTEM**

DSI, DIM 1-10V, Phase-cut

**CONTROL SYSTEM**

Bluetooth

**FINISHING**

 Other Colours

**SENSORS**

Motion

**ERUS 25 SUSPENDED**

Beam Angle (°)	h (mm)	Output (lm)	LED Power (W)	MATT WHITE	MATT BLACK
<b>2700 K</b>					
30°	350	326	5	33.18.005.08.00	33.18.005.08.18
	450	326	5	33.18.005.08.06	33.18.005.08.24
	550	326	5	33.18.005.08.12	33.18.005.08.30
45°	350	343	5	33.18.005.08.01	33.18.005.08.19
	450	343	5	33.18.005.08.07	33.18.005.08.25
	550	343	5	33.18.005.08.13	33.18.005.08.31
<b>3000 K</b>					
30°	350	352	5	33.18.005.08.02	33.18.005.08.20
	450	352	5	33.18.005.08.08	33.18.005.08.26
	550	352	5	33.18.005.08.14	33.18.005.08.32
45°	350	370	5	33.18.005.08.03	33.18.005.08.21
	450	370	5	33.18.005.08.09	33.18.005.08.27
	550	370	5	33.18.005.08.15	33.18.005.08.33
<b>4000 K</b>					
30°	350	379	5	33.18.005.08.04	33.18.005.08.22
	450	379	5	33.18.005.08.10	33.18.005.08.28
	550	379	5	33.18.005.08.16	33.18.005.08.34
45°	350	398	5	33.18.005.08.05	33.18.005.08.23
	450	398	5	33.18.005.08.11	33.18.005.08.29
	550	398	5	33.18.005.08.17	33.18.005.08.35



SCALE 1:1

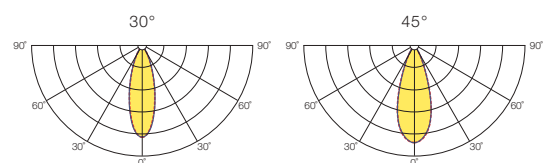
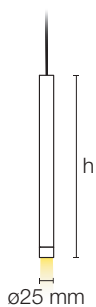

# ERUS 25

## SUSPENDED

### COMPONENTS



#### RECESSED CEILING CUP (1pc)

FINISHING	DIMENSION	1m	3m	5m
Matt White	Ø80 mm	35.18.001.01.83	35.18.001.01.84	35.18.001.01.85
Matt Black	Ø80 mm	35.18.001.01.86	35.18.001.01.87	35.18.001.01.88



#### RECESSED CEILING CUP (1pc)

FINISHING	DIMENSION	1m	3m	5m
Matt White	Ø20 mm	35.18.001.01.89	35.18.001.01.90	35.18.001.01.91
Matt Black	Ø20 mm	35.18.001.01.92	35.18.001.01.93	35.18.001.01.94



#### DRIVER - EXTERNAL

CLASS II

ON/OFF	DIMENSION	COD
Power Supply 2-7W IP20	23x32x76 mm	35.92.00.000024
Power Supply 8-18W IP20	23x38x125 mm	35.06.60.000661

DALI	DIMENSION	COD
Power Supply 2-17W IP20	22x52x108 mm	35.92.00.000026
Power Supply 17-22W IP20	31x70x200 mm	35.92.00.000032

> External Driver to be housed nearby.



> **ERUS 25** SUSPENDED

# ERUS 55 SUSPENDED



## PT

- > Luminária decorativa de aplicação suspensa.
- > Formato tubular diâmetro 55 mm com diversos comprimentos disponíveis.
- > As versões COB (Chip On Board) têm lente integrada com ângulos de abertura de 24° ou 36°.
- > Fonte de alimentação incorporada.
- > Também disponíveis versões para lâmpadas com suporte GU10.
- > Aplicação suspensa com opção de florão saliente ou de encastrar.
- > Tubo em alumínio com revestimento a epoxy-poliéster.

## ES

- > Luminaria decorativa para aplicación suspendida.
- > Formato tubular diámetro 55 mm disponible en varias longitudes.
- > Las versiones COB (Chip On Board) tienen lente integrada con ángulos de apertura de 24° o 36°.
- > Fuente de alimentación incorporada.
- > También están disponibles versiones para lámparas con soporte GU10.
- > Aplicación suspendida con opción de florón para instalación adosada o empotrada.
- > Tubo en aluminio con recubrimiento epoxi-poliéster.

**QUICK INFO**

**GENERAL**

Suspended  
 IP20  
 650°C  
 Class I  
 Ta= -20°C +35°C

**OPTIC**

Polycarbonate Reflector  
 PMMA Diffuser

**LED**

Efficacy up to 104 lm/W  
 2700 K, 3000 K, 4000 K  
 CRI >92  
 Lifetime 50 000 H  
 L90/B10 @Tc=75°C

**ELECTRICAL SYSTEM**

230V/50Hz  
 ON/OFF, DALI

**FINISHING**

RAL 9003 Matt White

**OPTIONS**

**ELECTRICAL SYSTEM**

DSI, DIM 1-10V, Phase-cut

**CONTROL SYSTEM**

Bluetooth

**FINISHING**

 Other Colours

**SENSORS**

Motion

**ERUS 55 SUSPENDED**

**MATT WHITE FINISHING**

Beam Angle (°)	h (mm)	Output (lm)	System (W)	ON/OFF	DALI
<b>2700 K</b>					
24°	350	1140	14	33.18.012.08.00	33.18.012.08.36
	450	1140	14	33.18.012.08.12	33.18.012.08.48
	550	1140	14	33.18.012.08.24	33.18.012.08.60
36°	350	1140	14	33.18.012.08.01	33.18.012.08.37
	450	1140	14	33.18.012.08.13	33.18.012.08.49
	550	1140	14	33.18.012.08.25	33.18.012.08.61
<b>3000 K</b>					
24°	350	1170	14	33.18.012.08.02	33.18.012.08.38
	450	1170	14	33.18.012.08.14	33.18.012.08.50
	550	1170	14	33.18.012.08.26	33.18.012.08.62
36°	350	1170	14	33.18.012.08.03	33.18.012.08.39
	450	1170	14	33.18.012.08.15	33.18.012.08.51
	550	1170	14	33.18.012.08.27	33.18.012.08.63
<b>4000 K</b>					
24°	350	1270	14	33.18.012.08.04	33.18.012.08.40
	450	1270	14	33.18.012.08.16	33.18.012.08.52
	550	1270	14	33.18.012.08.28	33.18.012.08.64
36°	350	1270	14	33.18.012.08.05	33.18.012.08.41
	450	1270	14	33.18.012.08.17	33.18.012.08.53
	550	1270	14	33.18.012.08.29	33.18.012.08.65

> Components Required - page 310.

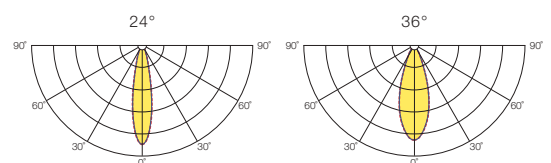
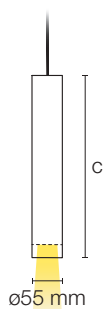

**QUICK INFO**

**GENERAL**

Suspended  
 IP20  
 650°C  
 Class I  
 Ta= -20°C +35°C

**OPTIC**

Polycarbonate Reflector  
 PMMA Diffuser

**LED**

Efficacy up to 104 lm/W  
 2700 K, 3000 K, 4000 K  
 CRI >92  
 Lifetime 50 000 H  
 L90/B10 @Tc=75°C

**ELECTRICAL SYSTEM**

230V/50Hz  
 ON/OFF, DALI

**FINISHING**

RAL 9005 Matt Black

**OPTIONS**

**ELECTRICAL SYSTEM**

DSI, DIM 1-10V, Phase-cut

**CONTROL SYSTEM**

Bluetooth

**FINISHING**

 Other Colours

**SENSORS**

Motion

**ERUS 55 SUSPENDED**

**MATT BLACK FINISHING**

Beam Angle (°)	h (mm)	Output (lm)	System (W)	ON/OFF	DALI
<b>2700 K</b>					
24°	350	1140	14	33.18.012.08.06	33.18.012.08.42
	450	1140	14	33.18.012.08.18	33.18.012.08.54
	550	1140	14	33.18.012.08.30	33.18.012.08.66
36°	350	1140	14	33.18.012.08.07	33.18.012.08.43
	450	1140	14	33.18.012.08.19	33.18.012.08.55
	550	1140	14	33.18.012.08.31	33.18.012.08.67
<b>3000 K</b>					
24°	350	1170	14	33.18.012.08.08	33.18.012.08.44
	450	1170	14	33.18.012.08.20	33.18.012.08.56
	550	1170	14	33.18.012.08.32	33.18.012.08.68
36°	350	1170	14	33.18.012.08.09	33.18.012.08.45
	450	1170	14	33.18.012.08.21	33.18.012.08.57
	550	1170	14	33.18.012.08.33	33.18.012.08.69
<b>4000 K</b>					
24°	350	1270	14	33.18.012.08.10	33.18.012.08.46
	450	1270	14	33.18.012.08.22	33.18.012.08.58
	550	1270	14	33.18.012.08.34	33.18.012.08.70
36°	350	1270	14	33.18.012.08.11	33.18.012.08.47
	450	1270	14	33.18.012.08.23	33.18.012.08.59
	550	1270	14	33.18.012.08.35	33.18.012.08.71

> Components Required - page 310.

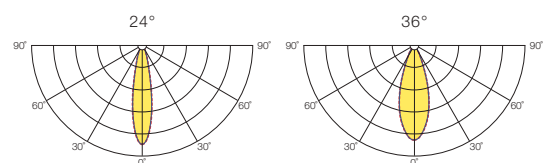

**QUICK INFO**

**GENERAL**

Suspended  
 IP20  
 650°C  
 Class I  
 Ta= -20°C +35°C

**LAMP - NOT INCLUDED**

GU10

**ELETRICAL SYSTEM**

230V/50Hz  
 ON/OFF

**FINISHING**

RAL 9003 Matt White  
 RAL 9005 Matt Black

**OPTIONS**

**CONTROL SYSTEM**

Bluetooth

**FINISHING**

 Other Colours

**SENSORS**

Motion

**ERUS 55 SUSPENDED - LAMP**

**MATT WHITE FINISHING**

Type	h (mm)	Lamp Power (W)	ON/OFF
<b>IP20</b>			
	350	max. 50	33.18.050.01.77
GU10	450	max. 50	33.18.050.01.78
	550	max. 50	33.18.050.01.79

> Lamp not included.  
 > Components Required - page 000.

**MATT BLACK FINISHING**

Type	h (mm)	Lamp Power (W)	ON/OFF
<b>IP20</b>			
	350	max. 50	33.18.050.01.80
GU10	450	max. 50	33.18.050.01.81
	550	max. 50	33.18.050.01.82

> Lamp not included.  
 > Components Required - page 310.

**RECOMENDED LAMPS**



**OSRAM**  
 PARATHOM  
 PAR 16  
 GU10  
 6,9 W



**PHILIPS**  
 Corepro  
 LEDspot  
 GU10  
 7 W

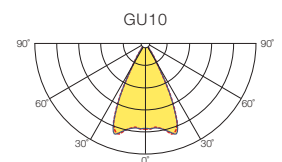
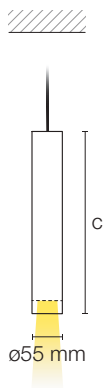

Lamp: 50W (GU10).

# ERUS 55

## SUSPENDED

### COMPONENTS



#### SURFACE CEILING CUP (1pc)

ON/OFF	DIMENSION	1m	3m	5m
Matt White	Ø62x36 mm	35.18.001.01.41	35.18.001.01.42	35.18.001.01.43
Matt Black	Ø62x36 mm	35.18.001.01.44	35.18.001.01.45	35.18.001.01.46
DALI	DIMENSION	1m	3m	5m
Matt White	Ø62x36 mm	35.18.001.01.59	35.18.001.01.60	35.18.001.01.61
Matt Black	Ø62x36 mm	35.18.001.01.62	35.18.001.01.63	35.18.001.01.64



#### RECESSED CEILING CUP (1pc)

ON/OFF	DIMENSION	1m	3m	5m
Matt White	Ø80 mm	35.18.001.01.47	35.18.001.01.48	35.18.001.01.49
Matt Black	Ø80 mm	35.18.001.01.50	35.18.001.01.51	35.18.001.01.52
DALI	DIMENSION	1m	3m	5m
Matt White	Ø80 mm	35.18.001.01.65	35.18.001.01.66	35.18.001.01.67
Matt Black	Ø80 mm	35.18.001.01.68	35.18.001.01.69	35.18.001.01.70



#### RECESSED CEILING CUP (1pc)

ON/OFF	DIMENSION	1m	3m	5m
Matt White	Ø25 mm	35.18.001.01.53	35.18.001.01.54	35.18.001.01.55
Matt Black	Ø25 mm	35.18.001.01.56	35.18.001.01.57	35.18.001.01.58
DALI	DIMENSION	1m	3m	5m
Matt White	Ø25 mm	35.18.001.01.71	35.18.001.01.72	35.18.001.01.73
Matt Black	Ø25 mm	35.18.001.01.74	35.18.001.01.75	35.18.001.01.76



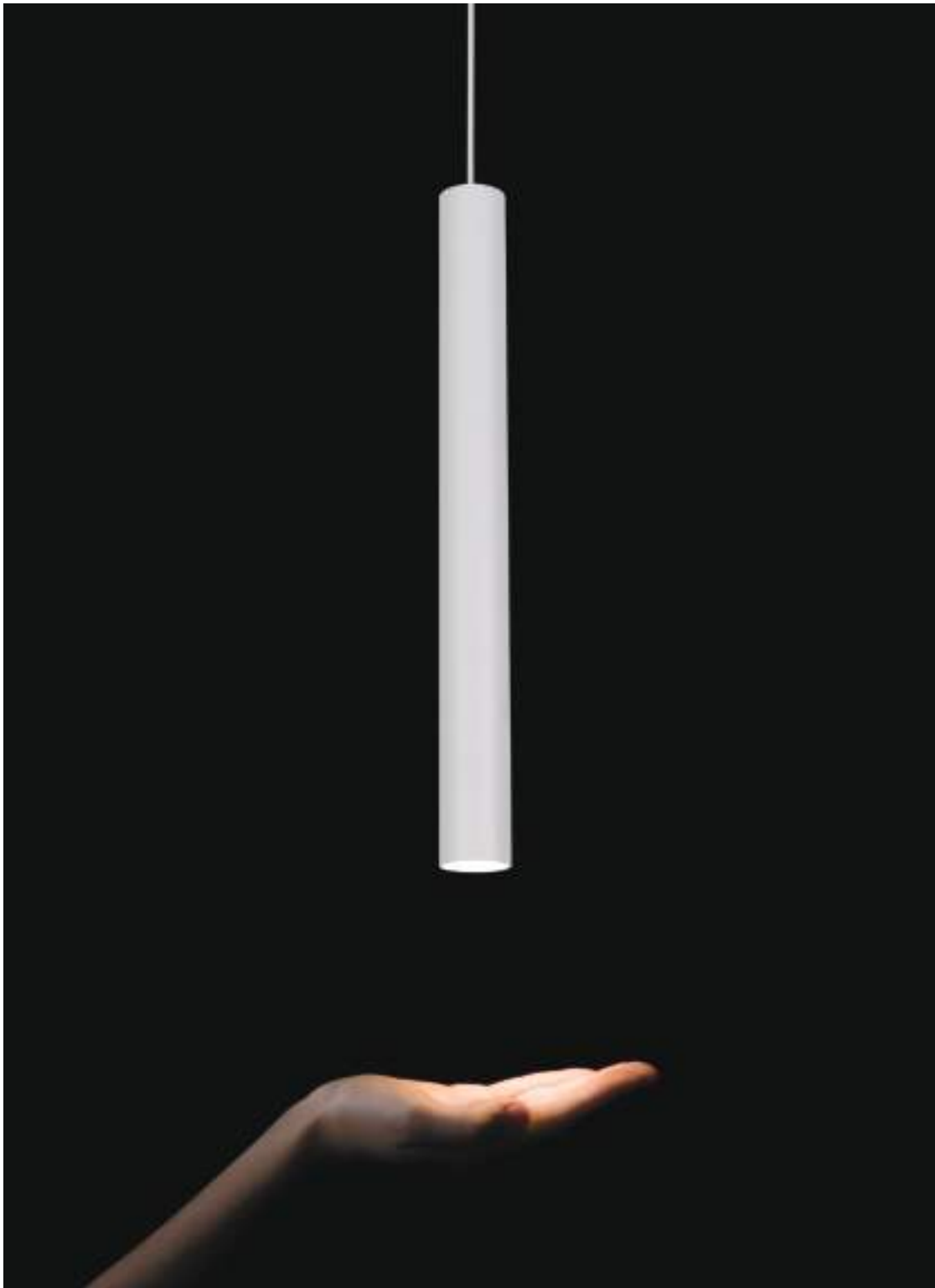

> **ERUS 55** SUSPENDED

# ERUS 90 SUSPENDED



## PT

- > Luminária decorativa de aplicação suspensa.
- > Formato tubular diâmetro 90 mm com diversos comprimentos disponíveis.
- > Aplicação suspensa com opção de florão saliente ou de encastrar.
- > Tubo em alumínio com revestimento a epoxy-poliéster.

## ES

- > Luminaria decorativa para aplicación suspendida.
- > Formato tubular diámetro 90 mm disponible en varias longitudes.
- > Aplicación suspendida con opción de florón para instalación adosada o empotrada.
- > Tubo en aluminio con recubrimiento epoxi-poliéster.

**QUICK INFO**

**GENERAL**

Suspended  
 IP20  
 960°C  
 Class I  
 Ta= -20°C +35°C

**LAMP - NOT INCLUDED**  
 GU10

**ELETRICAL SYSTEM**

230V/50Hz  
 ON/OFF

**FINISHING**

RAL 9003 Matt White  
 RAL 9005 Matt Black

**OPTIONS**

**CONTROL SYSTEM**

Bluetooth

**FINISHING**

 Other Colours

**SENSORS**

Motion

**ERUS 90 SUSPENDED - LAMP**

Type	h (mm)	Lamp Power (W)	MATT WHITE	MATT BLACK
<b>IP20</b>				
	350	max. 50	33.18.050.01.71	33.18.050.01.72
GU10	450	max. 50	33.18.050.01.73	33.18.050.01.74
	550	max. 50	33.18.050.01.75	33.18.050.01.76

> Lamp not included.

**COMPONENTS**



**SURFACE CEILING CUP (1pc)**

ON/OFF	1 m	3 m	5 m
Matt White Ø62x36 mm	35.18.001.01.41	35.18.001.01.42	35.18.001.01.43
Matt Black Ø62x36 mm	35.18.001.01.44	35.18.001.01.45	35.18.001.01.46



**RECESSED CEILING CUP (1pc)**

ON/OFF	1 m	3 m	5 m
Matt White Ø80 mm	35.18.001.01.47	35.18.001.01.48	35.18.001.01.49
Matt Black Ø80 mm	35.18.001.01.50	35.18.001.01.51	35.18.001.01.52



**RECESSED CEILING CUP (1pc)**

ON/OFF	1 m	3 m	5 m
Matt White Ø25 mm	35.18.001.01.53	35.18.001.01.54	35.18.001.01.55
Matt Black Ø25 mm	35.18.001.01.56	35.18.001.01.57	35.18.001.01.58

**RECOMENDED LAMPS**



**OSRAM**  
 PARATHOM  
 PAR 16  
 GU10  
 6,9 W



**PHILIPS**  
 Corepro  
 LEDspot  
 GU10  
 7 W

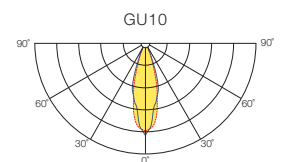

Lamp: 50W (GU10).

**ARES**  
SUSPENDED





> ARES LI SUSPENDED

# ARES DIRECT OR INDIRECT LIGHT SUSPENDED

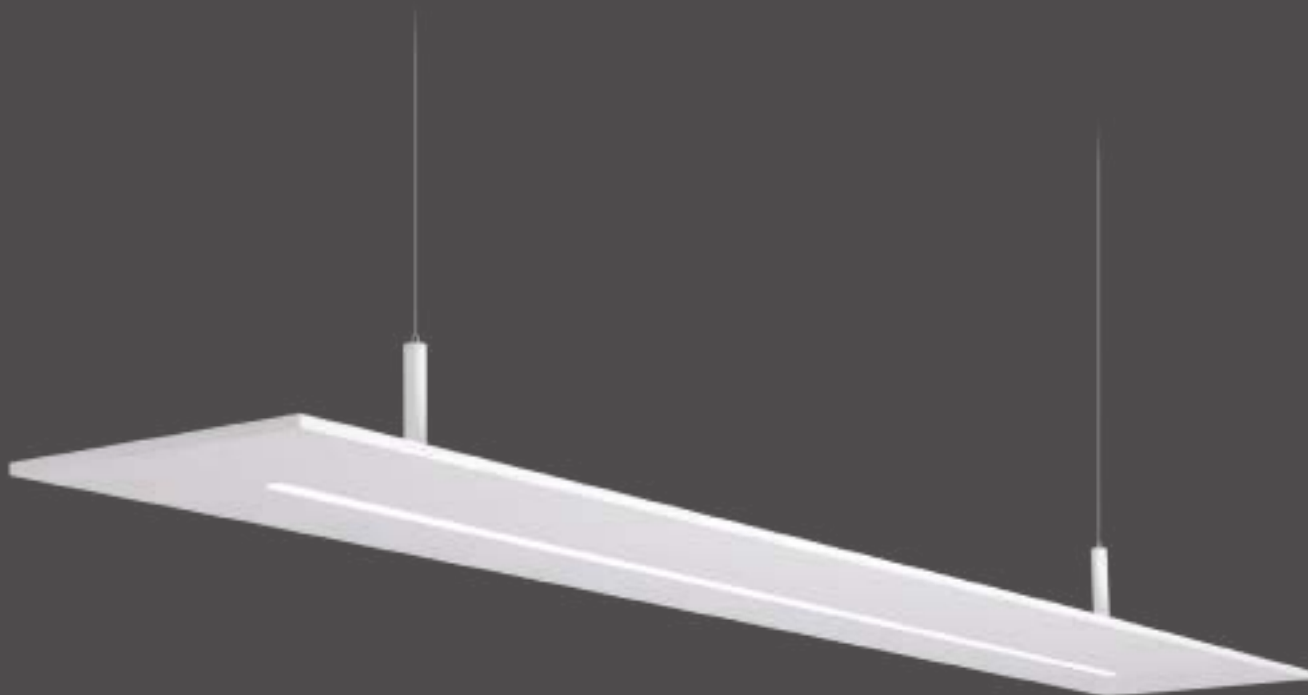

## PT

- > Luminária em perfil ultra-plano (apenas 10 mm) em versões de iluminação direta e direta/indireta.
- > De aplicação suspensa por cabos de aço inox com ajuste rápido da altura.
- > Difusor de luz direta em Policarbonato Transparente para otimização do fluxo luminoso.
- > Elemento de luz indireta em Policarbonato Opal para iluminação homogénea, difusa e eficiente.
- > Corpo em alumínio com revestimento a epoxy-poliéster.

## ES

- > Luminaria de perfil extra plano (sólo 10 mm) en versiones de iluminación directa y directa/indirecta.
- > De aplicación suspendida por cables de acero inoxidable con regulación de la altura.
- > Difusor luz directa en Policarbonato Transparente para un flujo luminoso optimizado.
- > Elemento indirecto en Policarbonato Opal.
- > Cuerpo en aluminio con recubrimiento epoxy-poliéster.

**QUICK INFO**

**GENERAL**

Suspended  
IP30  
850°C  
Class I  
Ta= -20°C +35°C

**OPTIC**

Opal Polycarbonate  
Clear Polycarbonate

**LED**

Efficacy up to 173 lm/W  
3000 K, 4000 K  
CRI >80  
Lifetime 72 000 H  
L80/B10 @Tc=65°C

**ELETRICAL SYSTEM**

230V/50Hz  
DALI  
Direct / Indirect - Simultaneous Control

**FINISHING**

RAL 9003 Matt White

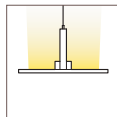

**ARES SUSPENDED - INDIRECT LIGHT  
OPAL DIFFUSER**

c (mm)	Output (lm)	System (W)	DALI
<b>3000 K</b>			
1640	5983	50	33.06.40.001430
2200	8974	75	33.06.40.001431
<b>4000 K</b>			
1640	6262	50	33.06.40.001432
2200	9392	75	33.06.40.001433

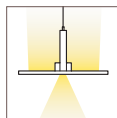

**ARES SUSPENDED - DIRECT & INDIRECT LIGHT  
OPAL + CLEAR DIFFUSER**

c (mm)	Output (lm)	System (W)	DALI
<b>3000 K</b>			
1640	6440	64	33.06.40.001357
2200	9889	104	33.06.40.001358
<b>4000 K</b>			
1640	6746	64	33.06.40.001359
2200	10361	104	33.06.40.001360

**OPTIONS**

**LED**

2700 K, 5000 K, 6500 K  
Tunable White

**ELECTRICAL SYSTEM**

DSI, DIM 1-10V, Phase-cut  
Direct / Indirect - Separate Control

**CONTROL SYSTEM**

Bluetooth

**FINISHING**

RAL 9005 Matt Black  
Other Colours

**EMERGENCY**

1 Hour, 3 Hours  
DALI 1 Hour, 3 Hours

**SENSORS**

Motion  
Ambient Light  
Motion & Ambient Light

**COMPONENTS**



**SUSPENSION SYSTEM (2pcs)**

TYPE	1 m	3 m	5 m
Matt White	35.42.000.01.54	35.42.000.01.62	35.42.001.01.26



**SURFACE CEILING CUP (1pc)**

DALI	1 m	3 m	5 m
Matt White Ø62x36 mm	35.42.001.01.82	35.42.001.01.90	35.42.001.01.98



**RECESSED CEILING CUP (1pc)**

DALI	1 m	3 m	5 m
Matt White Ø80 mm	35.42.001.01.86	35.42.001.01.94	35.42.002.01.02

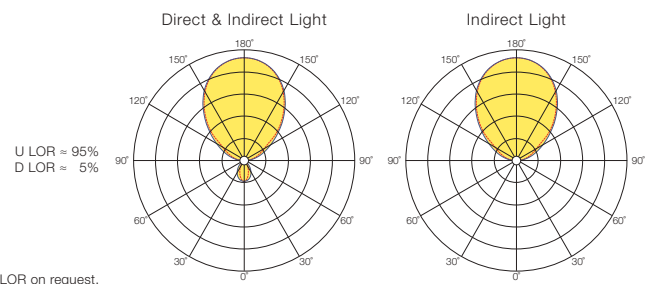
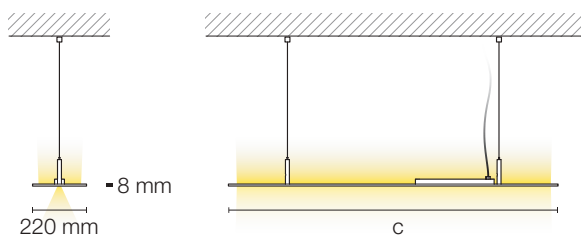

**SILVY**  
SUSPENDED







# SILVY

INDIRECT LIGHT

## SUSPENDED



### PT

- > Luminária em perfil ultra-plano (apenas 8 mm) com emissão indireta do fluxo luminoso.
- > De aplicação suspensa por cabos de aço inox com ajuste rápido da altura.
- > Três dimensões disponíveis na versão circular e duas na versão oval.
- > Corpo em alumínio com revestimento a epoxy-poliéster.

### ES

- > Luminaria de perfil extra plano (sólo 8 mm) con emisión indirecta del flujo luminoso.
- > De aplicación suspendida por cables de acero inoxidable con regulación de la altura.
- > Tres tamaños disponibles en la versión circular y dos en la versión oval.
- > Cuerpo en aluminio con recubrimiento epoxi-poliéster.

**QUICK INFO**

**GENERAL**

Suspended  
 IP30  
 850°C  
 Class I  
 Ta= -20°C +35°C

**OPTIC**

Opal Polycarbonate

**LED**

Efficacy up to 99 lm/W  
 3000 K, 4000 K  
 CRI >80  
 Lifetime 50 000 H  
 L70/B10 @Tc=65°C

**ELETRICAL SYSTEM**

230V/50Hz  
 ON/OFF

**FINISHING**

RAL 9003 Matt White  
 RAL 9005 Matt Black

**SILVY OVAL SUSPENDED - INDIRECT LIGHT**

**OPAL DIFFUSER**

a x b (mm)	Output (lm)	System (W)	MATT WHITE	MATT BLACK
<b>3000 K</b>				
650x1500	4356	67	33.06.40.001341	33.06.40.001342
900x1900	5227	80	33.06.40.001343	33.06.40.001344
<b>4000 K</b>				
650x1500	4570	67	33.06.40.001351	33.06.40.001352
900x1900	5485	80	33.06.40.001353	33.06.40.001354

**COMPONENTS**

**SUSPENSION SYSTEM**

**S1**

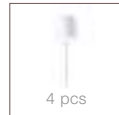

4 pcs

4 Points Suspension +  
 Recessed Ceiling Cup

**S2**

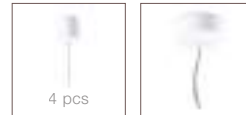

4 pcs

4 Points Suspension +  
 Surface Ceiling Cup

ON/OFF	1 m	3 m	5 m
S1 - White Ø80 mm	35.06.40.003015	35.06.40.003017	35.06.40.003019
S2 - White Ø350x50 mm	35.06.40.003016	35.06.40.003018	35.06.40.003020

**OPTIONS**

**LED**

2700 K, 5000 K

**ELECTRICAL SYSTEM**

DALI, DSI, DIM 1-10V, Phase-cut

**CONTROL SYSTEM**

Bluetooth

**FINISHING**

Other Colours

**SENSORS**

Motion  
 Ambient Light  
 Motion & Ambient Light

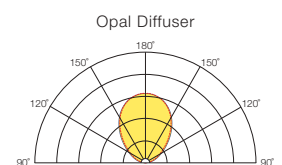
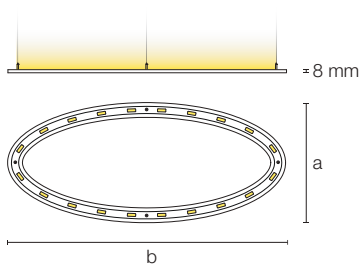

**QUICK INFO**

**GENERAL**

Suspended  
 IP30  
 850°C  
 Class I  
 Ta= -20°C +35°C

**OPTIC**

Opal Polycarbonate

**LED**

Efficacy up to 99 lm/W  
 3000 K, 4000 K  
 CRI >80  
 Lifetime 50 000 H  
 L70/B10 @TC=65°C

**ELETRICAL SYSTEM**

230V/50Hz  
 ON/OFF

**FINISHING**

RAL 9003 Matt White  
 RAL 9005 Matt Black

**OPTIONS**

**LED**

2700 K, 5000 K

**ELECTRICAL SYSTEM**

DALI, DSI, DIM 1-10V, Phase-cut

**CONTROL SYSTEM**

Bluetooth

**FINISHING**

 Other Colours

**SENSORS**

Motion  
 Ambient Light  
 Motion & Ambient Light

**SILVY ROUND SUSPENDED - INDIRECT LIGHT**

**OPAL DIFFUSER**

Ø (mm)	Output (lm)	System (W)	MATT WHITE	MATT BLACK
<b>3000 K</b>				
440	1186	20	33.06.40.001335	33.06.40.001336
600	1780	30	33.06.40.001337	33.06.40.001338
900	3917	67	33.06.40.001339	33.06.40.001340
<b>4000 K</b>				
440	1246	20	33.06.40.001345	33.06.40.001346
600	1868	30	33.06.40.001347	33.06.40.001348
900	4109	67	33.06.40.001349	33.06.40.001350

**COMPONENTS**

**SUSPENSION SYSTEM**

**S1**

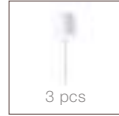

3 pcs  
 3 Points Suspension +  
 Recessed Ceiling Cup

**S2**



3 pcs  
 3 Points Suspension +  
 Surface Ceiling Cup

**S3**



1 Point Suspension +  
 Surface Ceiling Cup

**ON/OFF**

	1 m	3 m	5 m
S1 - White Ø80 mm	35.06.40.001634	35.06.40.002263	35.06.40.002266
S2 - White Ø350x50 mm	35.06.40.002271	35.06.40.002274	35.06.40.002277
S3 - White Ø350x50 mm	35.06.40.002272	35.06.40.002275	35.06.40.002278

SILVY 440

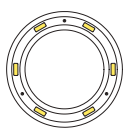
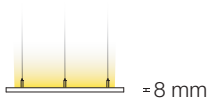

ø440 mm

SILVY 600

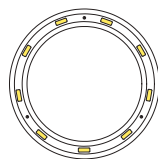
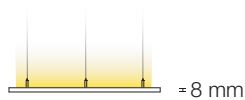

ø600 mm

SILVY 900

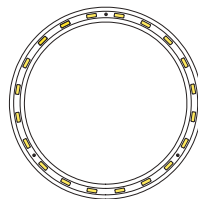

ø900 mm

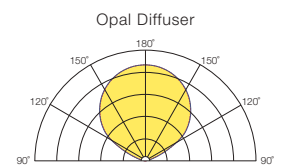



> SILVY ROUND 900 SUSPENDED S3

# DOURO AP-5

WALL



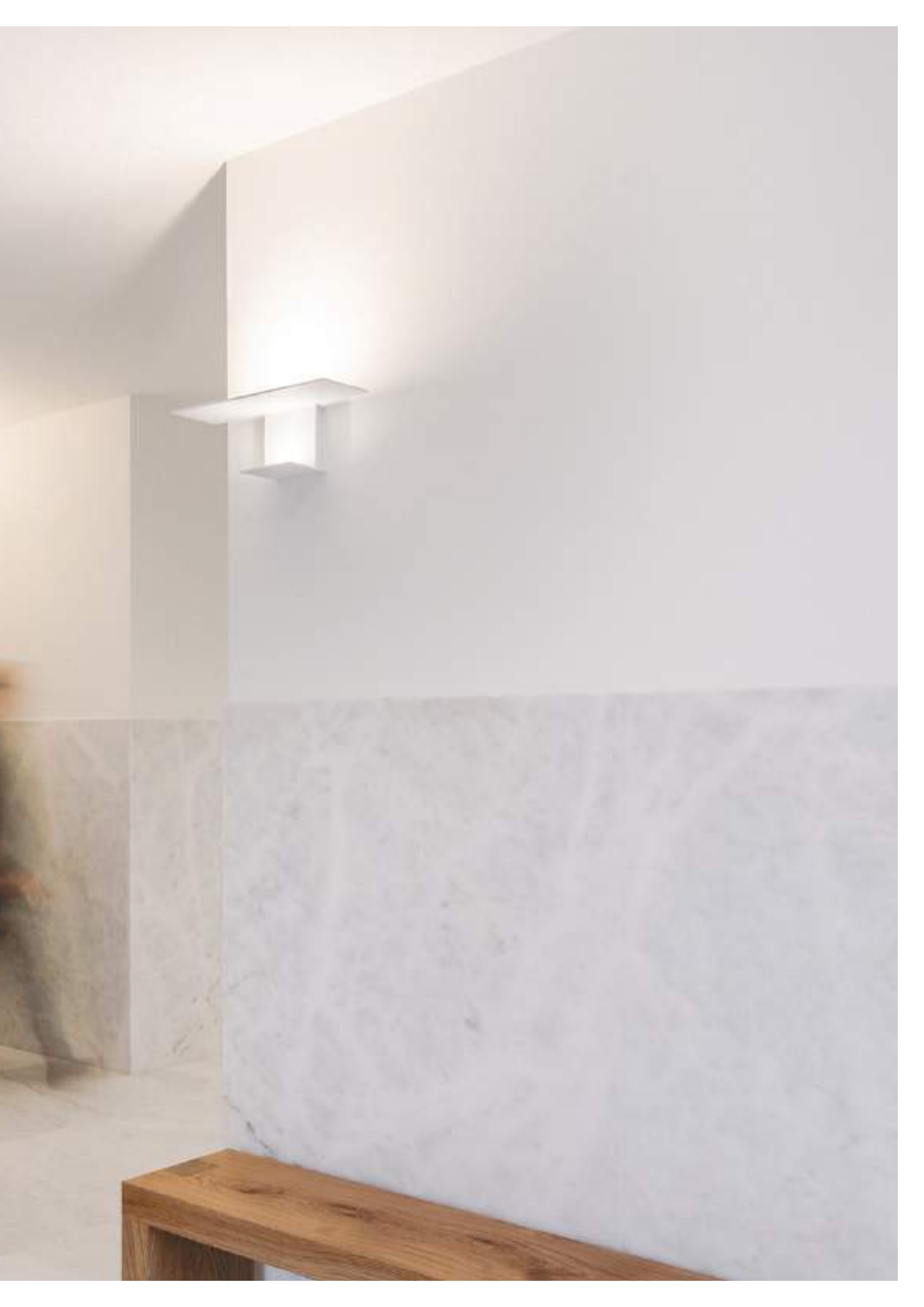

# DOURO AP-5 WALL

Design by Siza Vieira



## PT

- > Aplique de parede com emissão indireta.
- > Fluxo luminoso indireto em dois níveis.
- > Ideal para criar ambientes relaxantes e acolhedores em hotéis, restaurantes e zonas de passagem em interiores.
- > Fonte de alimentação incorporada.
- > Corpo em alumínio com acabamento em branco mate.

## ES

- > Aplique de pared con emisión indirecta.
- > Flujo luminoso indirecto en dos niveles.
- > Ideal para crear un ambiente tranquilo y acogedor en hoteles, restaurantes y zonas de paso interiores.
- > Fuente de alimentación incorporada.
- > Cuerpo en aluminio acabado en blanco mate.



**QUICK INFO****GENERAL**

Wall  
 IP40  
 960°C  
 Class II  
 Ta= -20°C +35°C

**OPTIC**

Opal Glass

**LED**

Efficacy up to 150 lm/W  
 3000 K  
 CRI >80  
 Lifetime 50 000 H  
 L70/B10 @Tc=65°C

**ELETRICAL SYSTEM**

230V/50Hz  
 ON/OFF

**FINISHING**

RAL 9003 Matt White

**OPTIONS****LED**

2700 K, 5000 K, 6500 K  
 CRI >90

**ELECTRICAL SYSTEM**

DSI, DIM 1-10V, Phase-cut

**CONTROL SYSTEM**

Bluetooth

**FINISHING**

 Other Colours

**EMERGENCY**

1 Hour, 3 Hours  
 DALI 1 Hour, 3 Hours

**SENSORS**

Motion  
 Ambient Light  
 Motion & Ambient Light

**DOURO AP-5 WALL****OPAL GLASS**

Output (lm)	System (W)	MATT WHITE
<b>3000 K</b>		
3035	31	33.06.20.000031

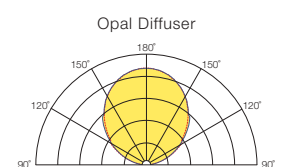
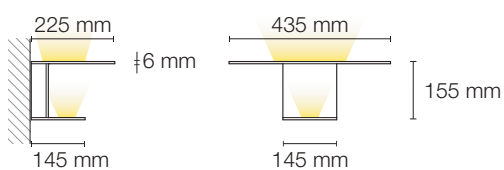

# DOURO AP-7 WALL

Design by Siza Vieira

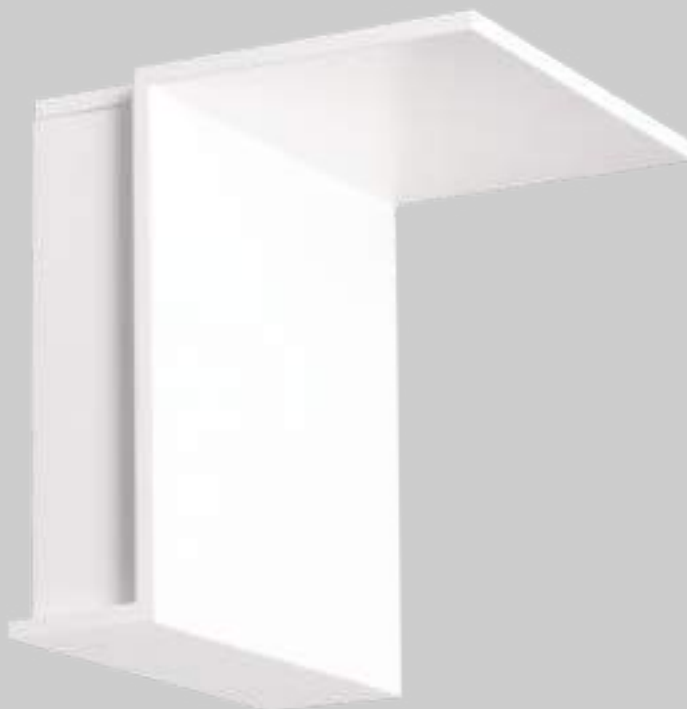

## PT

- > Aplique de parede com emissão indireta do fluxo luminoso.
- > Ideal para criar ambientes relaxantes e acolhedores em hotéis, restaurantes e zonas de passagem em interiores.
- > Fonte de alimentação incorporada.
- > Corpo em alumínio com acabamento em branco mate.

## ES

- > Aplique de pared con emisión indirecta del flujo luminoso.
- > Ideal para crear un ambiente tranquilo y acogedor en hoteles, restaurantes y zonas de paso interiores.
- > Fuente de alimentación incorporada.
- > Cuerpo en aluminio acabado en blanco mate.

**QUICK INFO****GENERAL**

Wall  
 IP40  
 960°C  
 Class II  
 Ta= -20°C +35°C

**OPTIC**

Opal Glass

**LED**

Efficacy up to 139 lm/W  
 3000 K  
 CRI >80  
 Lifetime 50 000 H  
 L70/B10 @Tc=65°C

**ELETRICAL SYSTEM**

230V/50Hz  
 ON/OFF

**FINISHING**

RAL 9003 Matt White

**OPTIONS****LED**

2700 K, 5000 K, 6500 K  
 CRI >90

**ELECTRICAL SYSTEM**

DSI, DIM 1-10V, Phase-cut

**CONTROL SYSTEM**

Bluetooth

**FINISHING**

 Other Colours

**EMERGENCY**

1 Hour, 3 Hours  
 DALI 1 Hour, 3 Hours

**SENSORS**

Motion  
 Ambient Light  
 Motion & Ambient Light

**DOURO AP-7 WALL****OPAL GLASS**

Output (lm)	System (W)	MATT WHITE
<b>3000 K</b>		
1483	16	33.06.20.000033

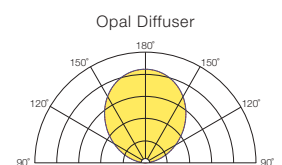
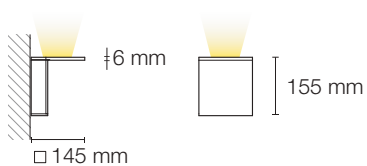

# DOURO MC

## TABLE LAMP

Design by Siza Vieira



### PT

- > Candeeiro de secretária com iluminação direta.
- > Distingue-se por um estilo único, através de uma luz inspiradora, eficiente e confortável.
- > Inclui Driver de parede e cabo de alimentação.
- > Base da luminária equipada com borracha de proteção anti-riscos.
- > Corpo em alumínio com acabamento em branco mate.

### ES

- > Lámpara de mesa con iluminación directa.
- > Lámpara que se distingue por un estilo único a través de una luz inspiradora, eficiente y comfortable.
- > Incluye Driver de pared y cable de alimentación.
- > La base de la luminaria está provista de tacos de goma antirayaduras.
- > Cuerpo en aluminio acabado en blanco mate.

**QUICK INFO****GENERAL**

Table Lamp  
 IP40  
 850°C  
 Class II  
 Ta= -20°C +35°C

**OPTIC**

Opal Polycarbonate

**LED**

Efficacy up to 95 lm/W  
 3000 K  
 CRI >85  
 Lifetime 50 000 H  
 L70/B10 @TC=65°C

**ELETRICAL SYSTEM**

230V/50Hz  
 ON/OFF

**FINISHING**

RAL 9003 Matt White

**OPTIONS****LED**

2700 K, 4000 K, 5000 K

**CONTROL SYSTEM**

Bluetooth

**FINISHING**

 Other Colours

**DOURO MC TABLE LAMP****OPAL GLASS**

Output (lm)	System (W)	MATT WHITE
<b>3000 K</b>		
434	6	33.06.50.000044

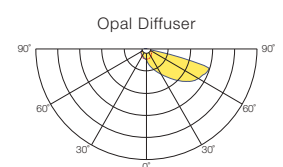
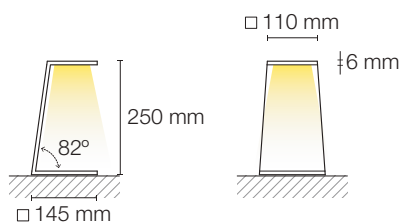

# DOURO PA-2

## FLOOR

Design by Siza Vieira

### PT

- > Candeeiro de pé alto com iluminação direta e indireta.
- > Distribuição do fluxo luminoso: 50% emissão direta e 50% emissão indireta.
- > Interruptor de pé incluído.
- > Corpo em alumínio com acabamento em branco mate.

### ES

- > Lámpara de pie con iluminación directa y indirecta.
- > Distribución del flujo luminoso: 50% en emisión directa y 50% en emisión indirecta.
- > Interruptor de pie incluido.
- > Cuerpo en aluminio acabado en blanco mate.



**QUICK INFO****GENERAL**

Floor  
 IP40  
 850°C  
 Class II  
 Ta= -20°C +35°C

**OPTIC**

Indirect Light - Opal Glass  
 Direct Light - Opal Polycarbonate

**LED**

Efficacy up to 139 lm/W  
 3000 K  
 CRI >80  
 Lifetime 50 000 H  
 L70/B10 @Tc=65°C

**ELETRICAL SYSTEM**

230V/50Hz  
 ON/OFF

**FINISHING**

RAL 9003 Matt White

**OPTIONS****LED**

2700 K, 4000 K, 5000 K

**CONTROL SYSTEM**

Bluetooth

**FINISHING**

 Other Colours

**DOURO PA-2 FLOOR****OPAL GLASS**

Output (lm)	System (W)	MATT WHITE
<b>3000 K</b>		
2695	31	33.06.10.000020

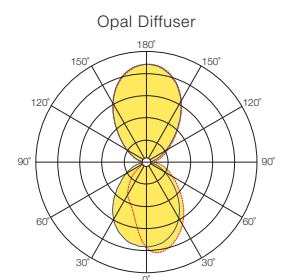
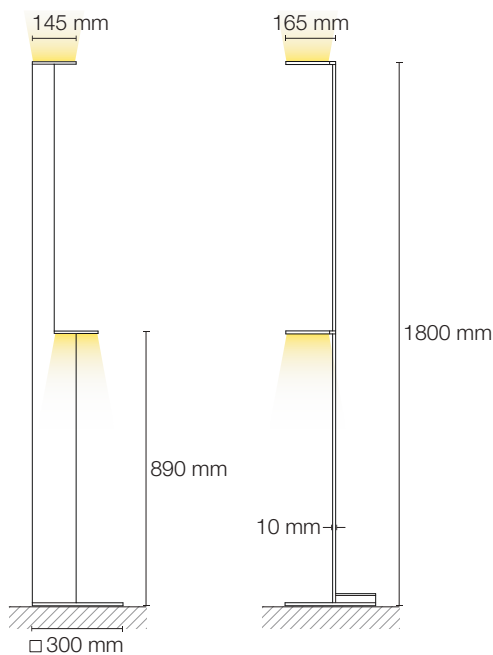

**A313**  
WALL







> A313 WALL

# A313 DIRECT & INDIRECT LIGHT WALL

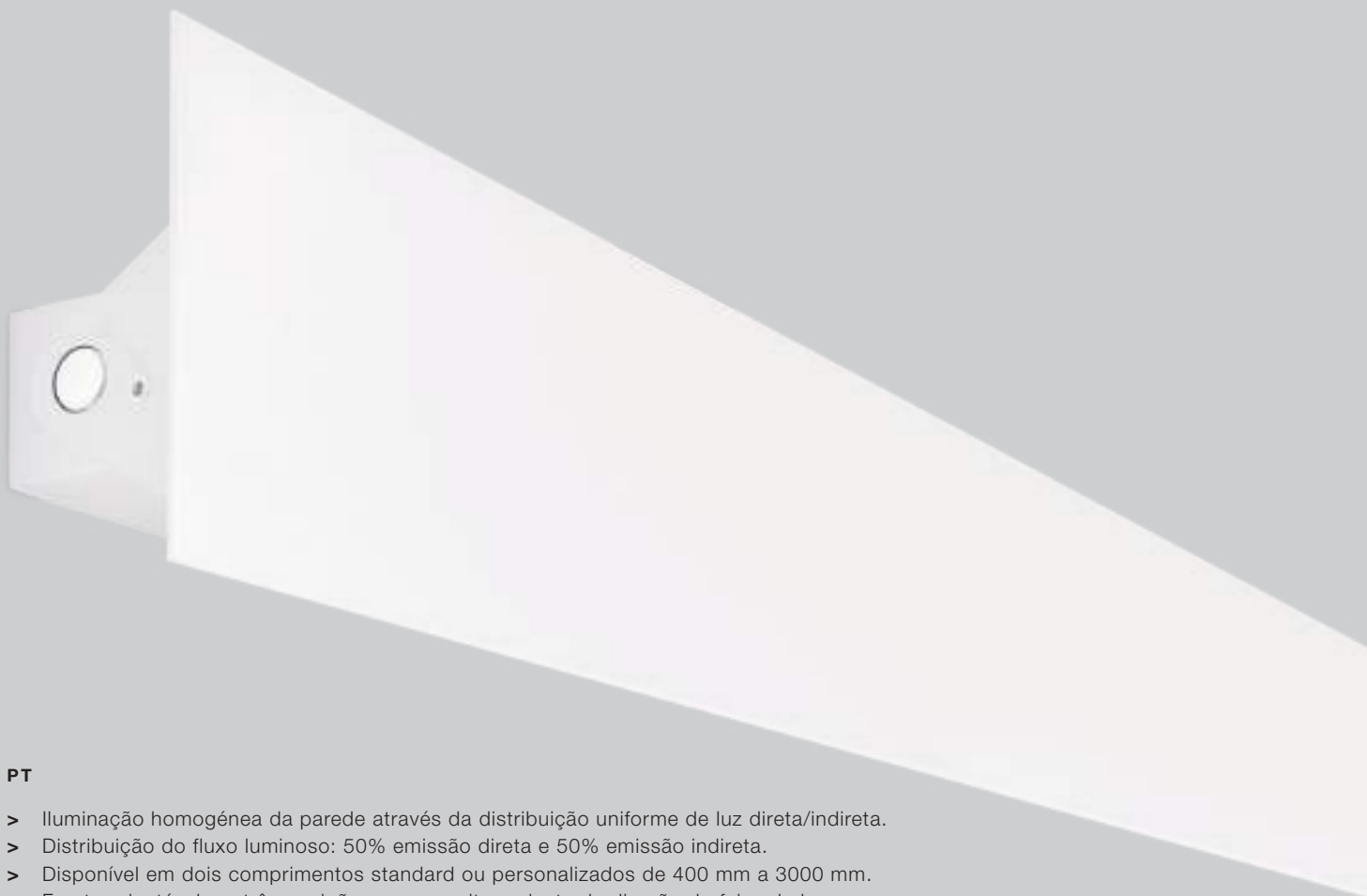

## PT

- > Iluminação homogénea da parede através da distribuição uniforme de luz direta/indireta.
- > Distribuição do fluxo luminoso: 50% emissão direta e 50% emissão indireta.
- > Disponível em dois comprimentos standard ou personalizados de 400 mm a 3000 mm.
- > Frente orientável em três posições que permite o ajuste da direção do feixe de luz.
- > Corpo em alumínio com revestimento a epoxy-poliéster.

## ES

- > Iluminación de pared homogénea mediante distribución uniforme de luz directa/indirecta.
- > Distribución del flujo luminoso: 50% en emisión directa y 50% en emisión indirecta.
- > Disponible en dos longitudes estándar o personalizados de 400 mm hasta 3000 mm.
- > Frente orientable en tres posiciones, que permite el ajuste de la dirección del haz de luz.
- > Cuerpo en aluminio con recubrimiento epoxy-poliéster.

ROTATION

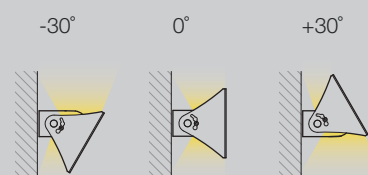

**QUICK INFO****GENERAL**

Wall  
IP30  
650°C  
Class I  
Ta= -20°C +35°C

**OPTIC**

Opal PMMA

**LED**

Efficacy up to 173 lm/W  
3000 K, 4000 K  
CRI >80  
Lifetime 72 000 H  
L80/B10 @TC=65°C

**ELETRICAL SYSTEM**

230V/50Hz  
ON/OFF, DALI

**FINISHING**

RAL 9003 Matt White

**A313 WALL - DIRECT & INDIRECT LIGHT  
OPAL DIFFUSER****MATT WHITE FINISHING**

c (mm)	Output (lm)	System (W)	ON/OFF	DALI
<b>3000 K</b>				
1282	2586	27	33.41.50.000023	33.41.50.000025
1563	3237	33	33.41.50.000024	33.41.50.000026
<b>4000 K</b>				
1282	2706	27	33.41.50.000027	33.41.50.000029
1563	3386	33	33.41.50.000028	33.41.50.000030

> Fluorescent lamp versions also available – product data at [www.climarlighting.com](http://www.climarlighting.com) – or by direct request to the factory.

**OPTIONS****EMERGENCY (EM) - SELF-TEST INTEGRATED**

ON/OFF	COD
EM 1H 3W	35.00.003.01.23
DALI	COD
EM 1H 5,4W DALI	35.00.004.01.54

> On request – External Emergency. Box dimensions: 45x120x360 mm.

**OPTIONS****LED**

2700 K, 5000 K, 6500 K  
Tunable White, RGB, RGBW

**ELECTRICAL SYSTEM**

DSI, DIM 1-10V, Phase-cut

**CONTROL SYSTEM**

Bluetooth

**FINISHING**

 Other Colours

**EMERGENCY**

1 Hour, 3 Hours  
DALI 1 Hour, 3 Hours

**SENSORS**

Motion

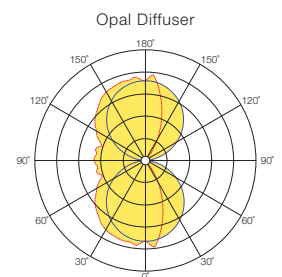
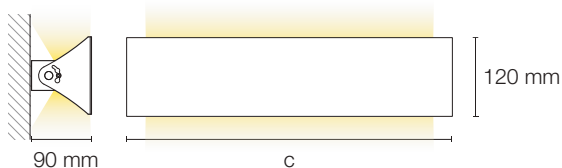

**BERKA**  
WALL





> BERKA WALL

# BERKA

INDIRECT LIGHT  
WALL



## PT

- > Aplique de parede com emissão indireta do fluxo luminoso.
- > Iluminação homogénea da parede devido à emissão de luz totalmente uniforme.
- > Difusor de proteção em Policarbonato Opal.
- > Corpo em alumínio com revestimento a epoxy-poliéster.

## ES

- > Aplique de pared con emisión indirecta del flujo luminoso.
- > Iluminación de pared homogénea gracias a la salida de luz totalmente uniforme.
- > Difusor de protección en Policarbonato Opal.
- > Cuerpo en aluminio con recubrimiento epoxy-poliéster.

**QUICK INFO****GENERAL**

Wall  
 IP30  
 850°C  
 Class I  
 Ta= -20°C +35°C

**OPTIC**

Opal Polycarbonate

**LED**

Efficacy up to 181 lm/W  
 3000 K, 4000 K  
 CRI >80  
 Lifetime 72 000 H  
 L80/B10 @TC=65°C

**ELECTRICAL SYSTEM**

230V/50Hz  
 ON/OFF, DALI

**FINISHING**

RAL 9003 Matt White  
 RAL 9005 Matt Black

**OPTIONS****LED**

2700 K, 5000 K, 6500 K  
 Tunable White, RGB, RGBW  
 CRI >90

**ELECTRICAL SYSTEM**

DSI, DIM 1-10V, Phase-cut

**CONTROL SYSTEM**

Bluetooth

**FINISHING**

 Other Colours

**EMERGENCY**

1 Hour, 3 Hours  
 DALI 1 Hour, 3 Hours

**SENSORS**

Motion

**BERKA WALL - INDIRECT LIGHT****OPAL DIFFUSER****MATT WHITE FINISHING**

c (mm)	Output (lm)	System (W)	ON/OFF	DALI
<b>3000 K</b>				
310	2145	20	33.06.20.000153	-
590	4275	40	33.06.20.000154	33.06.20.000155
<b>4000 K</b>				
310	2250	20	33.06.20.000156	-
590	4485	40	33.06.20.000157	33.06.20.000158

**MATT BLACK FINISHING**

c (mm)	Output (lm)	System (W)	ON/OFF	DALI
<b>3000 K</b>				
310	2145	20	33.06.20.000159	-
590	4275	40	33.06.20.000160	33.06.20.000161
<b>4000 K</b>				
310	2250	20	33.06.20.000162	-
590	4485	40	33.06.20.000163	33.06.20.000164

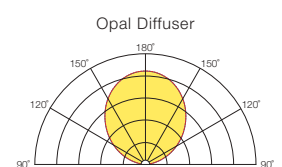
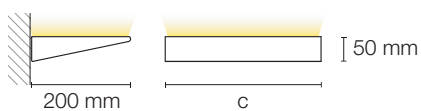

**STRETTO**  
WALL







# STRETTO

INDIRECT LIGHT  
WALL



## PT

- > Aplique de parede com emissão indireta do fluxo luminoso.
- > Iluminação homogénea da parede devido à emissão de luz totalmente uniforme.
- > Difusor de proteção em Policarbonato.
- > Corpo em alumínio com revestimento a epoxy-poliéster.

## ES

- > Aplique de pared con emisión indirecta del flujo luminoso.
- > Iluminación de pared homogénea gracias a la salida de luz totalmente uniforme.
- > Difusor de protección en Policarbonato.
- > Cuerpo en aluminio con recubrimiento epoxy-poliéster.

**QUICK INFO****GENERAL**

Wall  
IP40  
IK05  
850°C  
Class I  
Ta= -20°C +35°C

**OPTIC**

Clear Polycarbonate

**LED**

Efficacy up to 95 lm/W  
3000 K  
CRI >80  
Lifetime 50 000 H  
L70/B10 @Tc=65°C

**ELETRICAL SYSTEM**

230V/50Hz  
ON/OFF

**FINISHING**

RAL 9003 Matt White  
RAL 9005 Matt Black

**OPTIONS****LED**

2700 K, 4000 K, 5000 K, 6500 K  
Tunable White, RGB, RGBW  
CRI >90

**ELECTRICAL SYSTEM**

DALI, DSI, DIM 1-10V, Phase-cut

**CONTROL SYSTEM**

Bluetooth

**FINISHING**

 Other Colours

**EMERGENCY**

1 Hour, 3 Hours  
DALI 1 Hour, 3 Hours

**SENSORS**

Motion

**STRETTO WALL - INDIRECT LIGHT****OPAL DIFFUSER**

Output (lm)	System (W)	MATT WHITE	MATT BLACK
<b>3000 K</b>			
336	6,7	33.02.203.04.00	33.02.203.04.01
672	13	33.02.000.04.00	33.02.000.04.01

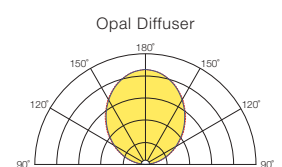
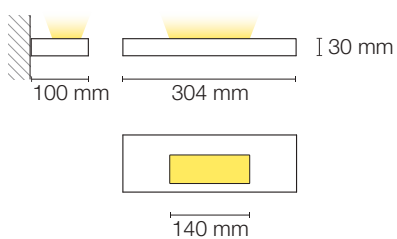

# NEXUS

DIRECT & INDIRECT LIGHT

## WALL



### PT

- > Aplique de parede para iluminação ambiente decorativa.
- > Iluminação homogénea da parede através da distribuição uniforme de luz direta/indireta.
- > Corpo em alumínio com revestimento a epoxy-poliéster.

### ES

- > Aplique de pared para iluminación ambiental decorativa.
- > Iluminación de pared homogénea mediante distribución uniforme de luz directa/indirecta.
- > Cuerpo en aluminio con recubrimiento epoxy-poliéster.

**QUICK INFO****GENERAL**

Wall  
 IP20  
 650°C  
 Class II  
 Ta= -20°C +35°C

**LED**

Efficacy up to 95 lm/W  
 3000 K  
 CRI >80  
 Lifetime 50 000 H  
 L70/B10 @TC=65°C

**ELECTRICAL SYSTEM**

230V/50Hz  
 ON/OFF

**FINISHING**

RAL 9003 Matt White

**OPTIONS****LED**

2700 K, 5000 K, 6500 K  
 Tunable White, RGB, RGBW  
 CRI >90

**ELECTRICAL SYSTEM**

DALI, DSI, DIM 1-10V, Phase-cut

**CONTROL SYSTEM**

Bluetooth

**FINISHING**

 Other Colours

**EMERGENCY**

1 Hour, 3 Hours  
 DALI 1 Hour, 3 Hours

**SENSORS**

Motion

**NEXUS WALL - DIRECT & INDIRECT LIGHT**

c (mm)	Output (lm)	System (W)	MATT WHITE
<b>3000 K</b>			
150	454	6,7	33.94.007.01.13
260	588	10	33.94.010.01.00

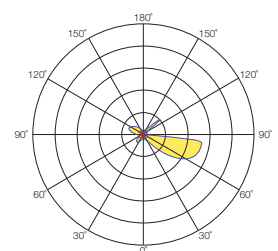
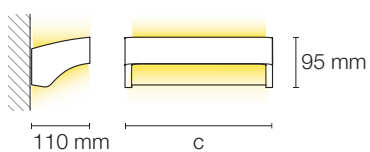

# ECLIPSE WALL





# ECLIPSE

INDIRECT LIGHT  
WALL

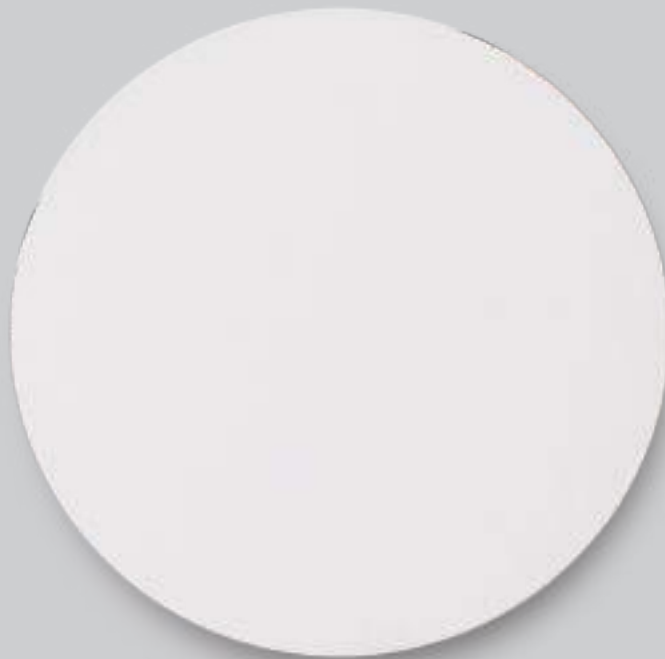

## PT

- > Aplique de parede para iluminação ambiente decorativa.
- > De aplicação encastrada em paredes ocas (gesso cartonado).
- > Design subtil que se integra facilmente na arquitetura.
- > Luminária com excelente difusão, sem encandeamento e criando uma suave iluminação ambiente.
- > Driver externo de corrente constante e classe proteção II.
- > Corpo em alumínio com revestimento a epoxy-poliéster.

## ES

- > Aplique de pared para iluminación ambiental decorativa.
- > De aplicación empotrada en pared hueca.
- > Diseño sutil que se integra fácilmente en la arquitectura.
- > Luminaria con una excelente difusión, sin deslumbramiento y creando una iluminación ambiental suave.
- > Driver externo de corriente constante y clase de protección II.
- > Cuerpo en aluminio con recubrimiento epoxi-poliéster.



**QUICK INFO****GENERAL**

Wall  
 IP40 (Optic)  
 IP20  
 850°C  
 Class III  
 Ta= -20°C +35°C

**OPTIC**

Clear PMMA

**LED**

Efficacy up to 129 lm/W  
 3000 K  
 CRI >80  
 Lifetime 50 000 H  
 L80/B10 @Tc=65°C  
 350 mA

**ELECTRICAL SYSTEM**

230V/50Hz  
 ON/OFF

**FINISHING**

RAL 9003 Matt White  
 RAL 9005 Matt Black

**OPTIONS****LED**

2700 K, 4000K, 5000 K, 6500 K  
 Tunable White, RGB, RGBW  
 CRI >90

**ELECTRICAL SYSTEM**

DSI, DIM 1-10V, Phase-cut

**CONTROL SYSTEM**

Bluetooth

**FINISHING**

 Other Colours

**EMERGENCY**

1 Hour, 3 Hours  
 DALI 1 Hour, 3 Hours

**SENSORS**

Motion

**ECLIPSE WALL - INDIRECT LIGHT  
 CLEAR DIFFUSER**

Ø (mm)	Output (lm)	LED Power (W)	MATT WHITE	MATT BLACK
			3000 K	
80	31	1,2	33.06.20.000007	33.06.20.000008
120	49	3,5	33.06.20.005000	33.06.20.005001

**COMPONENTS****DRIVER - EXTERNAL**

CLASS II

**ON/OFF**

Power Supply 1-5W IP20

**DIMENSION**

22x32x76 mm

**COD**

35.92.00.000023

Power Supply 7-13W IP20

23x38x125 mm

35.06.20.007005

> External Driver to be housed nearby.



ECLIPSE 80

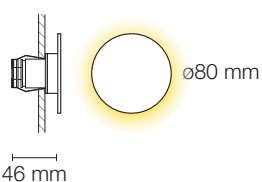

ECLIPSE 120

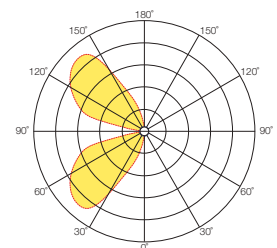
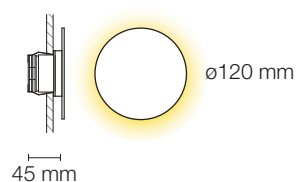

**BACO**  
WALL





> BACO IP44 WALL

# BACO DIRECT & INDIRECT LIGHT WALL



## PT

- > Iluminação homogénea da parede através da distribuição uniforme de luz direta/indireta.
- > Distribuição do fluxo luminoso: 50% emissão direta e 50% emissão indireta.
- > Versões IP44 com difusor de proteção em PMMA Opal.
- > Corpo em alumínio com revestimento em poliéster.

## ES

- > Iluminación de pared homogénea mediante distribución uniforme de luz directa/indirecta.
- > Distribución del flujo luminoso: 50% en emisión directa y 50% en emisión indirecta.
- > Versiones IP44 con difusor de protección en PMMA Opal.
- > Cuerpo en aluminio con recubrimiento de poliéster.

**QUICK INFO**

**GENERAL**

Wall  
 960°C (IP20)  
 650°C, IK07 (IP44)  
 Class I  
 Ta= -20°C +35°C

**OPTIC**

PMMA Opal (IP44)

**LAMP - NOT INCLUDED**

G9  
 E27

**ELETRICAL SYSTEM**

230V/50Hz  
 ON/OFF

**FINISHING**

RAL 9003 Matt White  
 RAL 9005 Matt Black

**BACO WALL - DIRECT & INDIRECT LIGHT**

**OPAL DIFFUSER**

**WITHOUT DIFFUSER**

a x b x h (mm)	Type	LAMP Power (W)	MATT WHITE	MATT BLACK
<b>IP20</b>				
90x90x90	G9	max. 40	33.34.040.01.02	33.34.040.01.04
120x120x120	G9	max. 60	33.34.060.01.03	33.34.060.01.09
200x200x200	E27	max. 75	33.34.075.01.04	33.34.075.01.16

> Lamp not included.

**WITH DIFFUSER**

a x b x h (mm)	Type	LAMP Power (W)	MATT WHITE	MATT BLACK
<b>IP44</b>				
100x100x100	G9	max. 25	33.34.025.01.02	33.34.025.01.01
150x150x150	G9	max. 40	33.34.040.01.08	33.34.040.01.07

> Lamp not included.

**OPTIONS**

**CONTROL SYSTEM**

Bluetooth

**FINISHING**

 Other Colours

**SENSORS**

Motion



BACO IP20

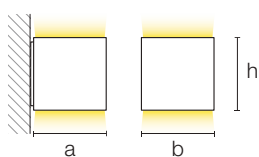

BACO IP44

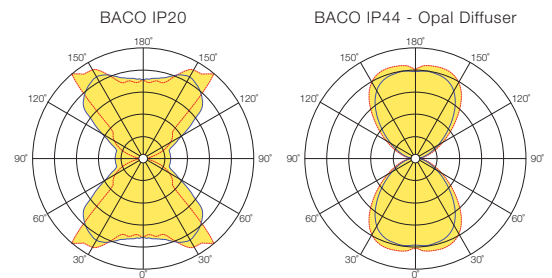
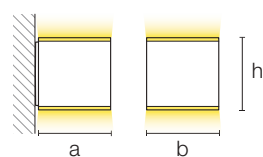

Lamp: 40W Halogen (G9).

**ODL-010 PA**  
WALL





# ODL-010 PA DIRECT LIGHT WALL



## PT

- > Aplique de parede com emissão direta do fluxo luminoso.
- > Índice de proteção IP44 adequado à aplicação em interior ou exterior.
- > Lente com ângulo de abertura de 25°.
- > Corpo em alumínio com revestimento em poliéster.

## ES

- > Aplique de pared con emisión directa del flujo luminoso.
- > Grado de protección IP44 apropiado para aplicación en interiores y exteriores.
- > Lente con ángulo de apertura de 25°.
- > Cuerpo en aluminio con recubrimiento de poliéster.



**QUICK INFO****GENERAL**

Wall  
IP44  
IK07  
750°C  
Class II  
Ta= -20°C +35°C

**LED**

Efficacy up to 125 lm/W  
3000 K, 5000 K  
CRI >80  
Lifetime 50 000 H  
L80/B10 @TC=65°C

**ELECTRICAL SYSTEM**

230V/50Hz  
ON/OFF

**FINISHING**

RAL 9003 Matt White  
RAL 9005 Matt Black  
Textured Grey

**OPTIONS****LED**

2700 K, 4000 K, 6500 K  
CRI >90

**ELECTRICAL SYSTEM**

DALI, DSI, DIM 1-10V, Phase-cut

**CONTROL SYSTEM**

Bluetooth

**FINISHING**

 Other Colours

**EMERGENCY**

1 Hour, 3 Hours  
DALI 1 Hour, 3 Hours

**SENSORS**

Motion

**ODL-010 PA WALL - DIRECT LIGHT****MATT WHITE FINISHING**

Output (lm)	System (W)	ON/OFF
<b>3000 K</b>		
196	2,8	33.94.003.08.26
<b>5000 K</b>		
242	2,8	33.94.003.08.30

**MATT BLACK FINISHING**

Output (lm)	System (W)	ON/OFF
<b>3000 K</b>		
196	2,8	33.94.003.08.27
<b>5000 K</b>		
242	2,8	33.94.003.08.31

**TEXTURED GREY FINISHING**

Output (lm)	System (W)	ON/OFF
<b>3000 K</b>		
196	2,8	33.94.003.08.24
<b>5000 K</b>		
242	2,8	33.94.003.08.28

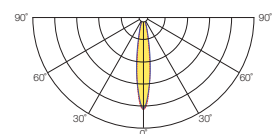
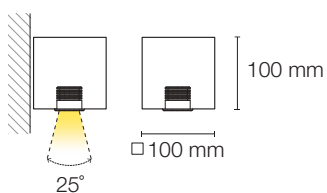

# ODL-015 PA DIRECT & INDIRECT LIGHT WALL



## PT

- > Aplique de parede com emissão direta e indireta do fluxo luminoso.
- > Distribuição do fluxo luminoso: 50% emissão direta e 50% emissão indireta.
- > Índice de proteção IP44 adequado à aplicação em interior ou exterior.
- > Lente com ângulo de abertura de 25°.
- > Corpo em alumínio com revestimento em poliéster.

## ES

- > Aplique de pared emisión directa e indirecta del flujo luminoso.
- > Distribución del flujo luminoso: 50% en emisión directa y 50% en emisión indirecta.
- > Grado de protección IP44 apropiado para aplicación en interiores y exteriores.
- > Lente con ángulo de apertura de 25°.
- > Cuerpo en aluminio con recubrimiento de poliéster.

**QUICK INFO**

**GENERAL**

Wall  
 IP44  
 IK07  
 750°C  
 Class II  
 Ta= -20°C +35°C

**LED**

Efficacy up to 125 lm/W  
 3000 K, 5000 K  
 CRI >80  
 Lifetime 50 000 H  
 L80/B10 @TC=65°C

**ELETRICAL SYSTEM**

230V/50Hz  
 ON/OFF  
 Direct / Indirect - Simultaneous Control

**FINISHING**

RAL 9003 Matt White  
 RAL 9005 Matt Black  
 Textured Grey

**OPTIONS**

**LED**

2700 K, 4000 K, 6500 K  
 CRI >90

**ELECTRICAL SYSTEM**

DALI, DSI, DIM 1-10V, Phase-cut

**CONTROL SYSTEM**

Bluetooth

**FINISHING**

 Other Colours

**EMERGENCY**

1 Hour, 3 Hours  
 DALI 1 Hour, 3 Hours

**SENSORS**

Motion

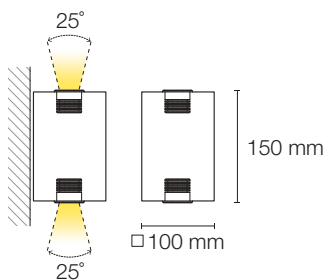

**ODL-015 PA WALL - DIRECT & INDIRECT LIGHT**

**MATT WHITE FINISHING**

Output (lm)	System (W)	ON/OFF
<b>3000 K</b>		
392	5,6	33.94.006.08.15
<b>5000 K</b>		
484	5,6	33.94.006.08.19

**MATT BLACK FINISHING**

Output (lm)	System (W)	ON/OFF
<b>3000 K</b>		
392	5,6	33.94.006.08.16
<b>5000 K</b>		
484	5,6	33.94.006.08.20

**TEXTURED GREY FINISHING**

Output (lm)	System (W)	ON/OFF
<b>3000 K</b>		
392	5,6	33.94.006.08.13
<b>5000 K</b>		
484	5,6	33.94.006.08.17

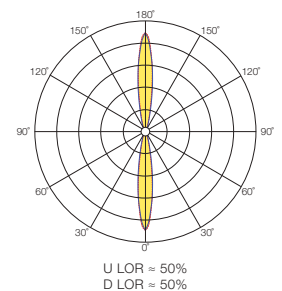



# TECHNICAL LIGHTING

## **RECESSED**

pag. 364

## **SURFACE**

pag. 376

## **DOWNLIGHTS**

pag. 390

## **TRACK & SPOTS**

pag. 462

## **RETAIL**

pag. 502

## **CLEANROOM**

pag. 554

## **WATERPROOF**

pag. 578

## **HIGH-BAY**

pag. 594

## **EMERGENCY**

pag. 614

**ADAAR WD**  
RECESSED

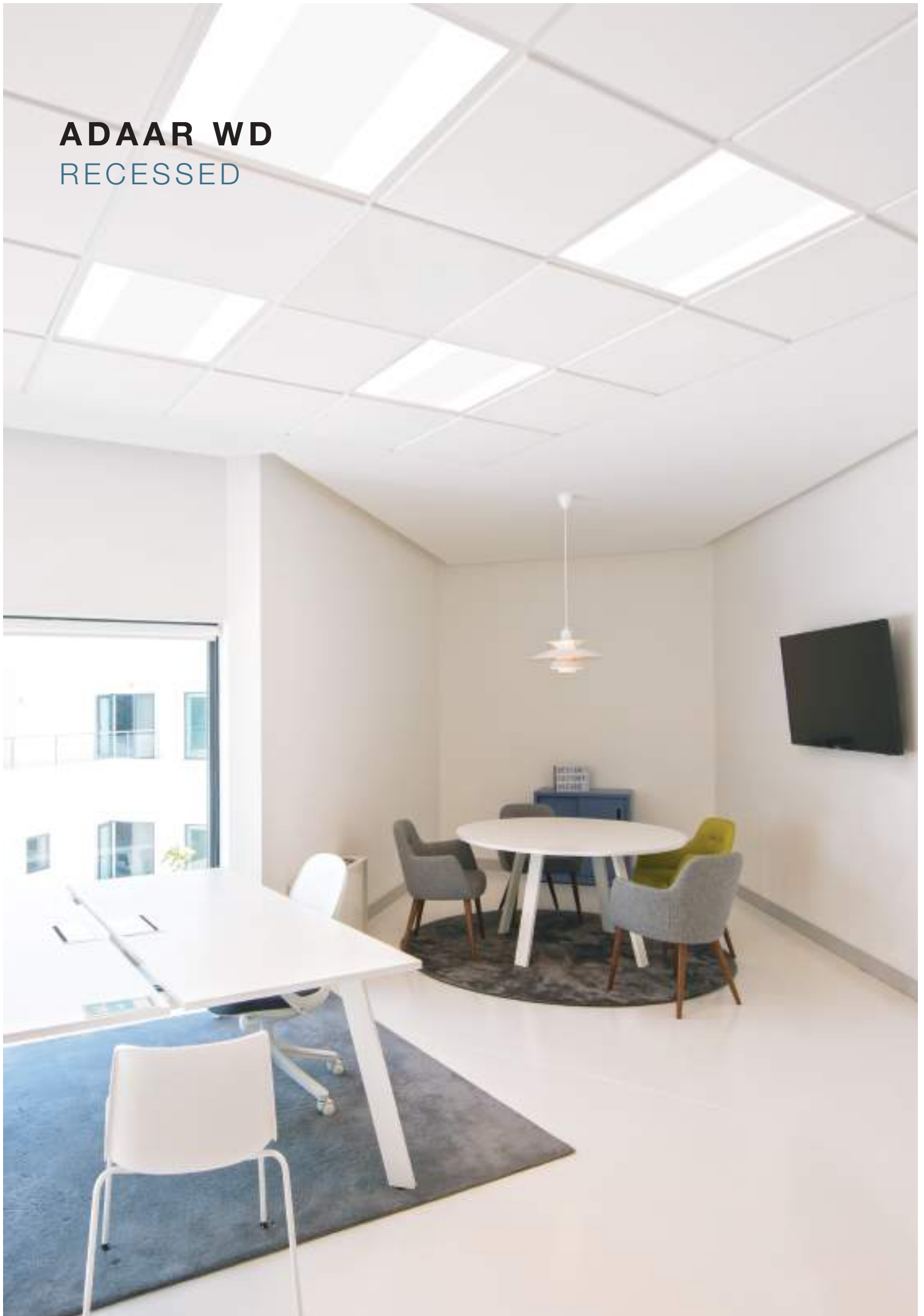



> ADAAR 3WD RECESSED

# ADAAR WD

## RECESSED



### PT

- > Luminária de luz homogénea para aplicação encastrada.
- > Aplicação em aberturas recortadas no teto ou em tetos modulares de 600x600 mm.
- > Com conjunto de niveladores para instalação rápida e sem ferramentas.
- > Proteção IP40 na face visível.
- > Versões de dois (2WD) ou três (3WD) elementos óticos com difusor PMMA Opal, ou em opção com difusor Microprismático.
- > Corpo em chapa de aço com revestimento a epoxy-poliéster.

### ES

- > Luminaria de luz homogénea para instalación empotrada.
- > Aplicación en huecos recortados en el techo o en techos modulares de 600x600 mm.
- > Con sistema de niveladores para el montaje rápido sin ayuda de herramientas.
- > Protección IP40 en el cuerpo visible.
- > Versiones de dos (2WD) o tres (3WD) elementos ópticos con difusor PMMA Opal o en opción con difusor Microprismático.
- > Cuerpo en chapa de acero con recubrimiento epoxy-poliéster.



**QUICK INFO**

**GENERAL**

Recessed  
 IP40 (Optic)  
 IP20  
 650°C  
 Class I  
 Ta= -20°C +35°C

**OPTIC**

Opal PMMA

**LED**

Efficacy up to 181 lm/W  
 3000 K, 4000 K  
 CRI >80  
 Lifetime 72 000 H  
 L80/B10 @Tc=65°C

**ELECTRICAL SYSTEM**

230V/50Hz  
 ON/OFF, DALI

**FINISHING**

RAL 9003 Matt White

**ADAAR WD RECESSED  
 OPAL DIFFUSER**

**2WD**

Output (lm)	System (W)	ON/OFF	DALI
<b>3000 K</b>			
2506	25	33.20.000.08.26	33.20.000.08.28
3352	32	33.20.000.08.27	33.20.000.08.29
<b>4000 K</b>			
2623	25	33.20.000.08.20	33.20.000.08.22
3508	32	33.20.000.08.21	33.20.000.08.23

**3WD**

Output (lm)	System (W)	ON/OFF	DALI
<b>3000 K</b>			
3822	38	33.20.000.08.34	33.20.000.08.36
5111	48	33.20.000.08.35	33.20.000.08.37
<b>4000 K</b>			
4000	38	33.20.000.08.38	33.20.000.08.40
5349	48	33.20.000.08.39	33.20.000.08.41

**OPTIONS**

**OPTIC**

Micro Prismatic PMMA - UGR <19

**LED**

2700 K, 5000 K, 6500 K  
 Tunable White, RGB, RGBW  
 CRI >90

**ELECTRICAL SYSTEM**

DSI, DIM 1-10V, Phase-cut

**CONTROL SYSTEM**

Bluetooth

**FINISHING**

 Other Colours

**EMERGENCY**

1 Hour, 3 Hours  
 DALI 1 Hour, 2 Hours

**SENSORS**

Motion  
 Ambient Light  
 Motion & Ambient Light

**OPTIONS**

**EMERGENCY (EM) - SELF-TEST INTEGRATED**

ON/OFF	COD
EM 1H 3W	35.00.003.01.23
EM 3H 3W	35.00.003.01.24
<b>DALI</b>	
EM 1H 5,4W DALI	35.00.004.01.54
EM 3H 5,4W DALI	35.00.004.01.55

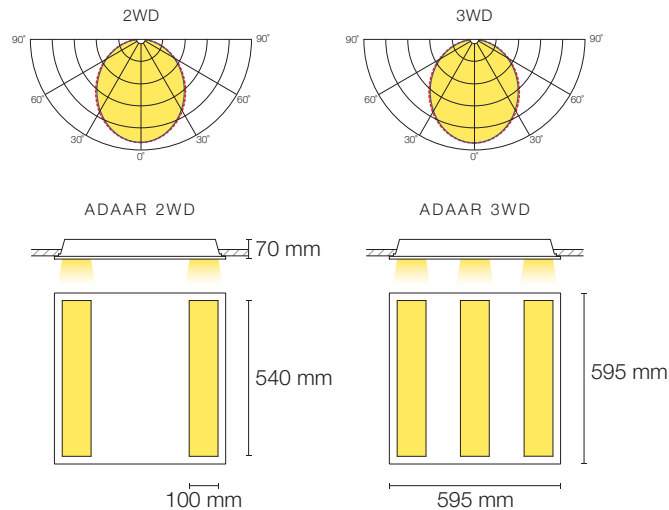

# ADAAR IP40, IP44

## RECESSED



### PT

- > Luminária de luz homogénea para aplicação encastrada.
- > Aplicação universal em aberturas recortadas no teto ou em tetos modulares.
- > Com conjunto de niveladores para instalação rápida e sem ferramentas.
- > Versões com proteção IP40 e IP44 na face visível.
- > Difusor PMMA Microprismático para controlo do encandeamento (UGR <19) ou difusor PMMA Opal para luz difusa.
- > Corpo em chapa de aço com revestimento a epoxy-poliéster.

### ES

- > Luminaria de luz homogénea para instalación empotrada.
- > Aplicación universal en huecos recortados en el techo o en techos modulares.
- > Con sistema de niveladores para el montaje rápido sin ayuda de herramientas.
- > Disponible en versiones con protección IP40 y IP44 en el cuerpo visible.
- > Difusor PMMA Microprismático para control del deslumbramiento (UGR <19) o difusor PMMA Opal.
- > Cuerpo de chapa de acero con recubrimiento epoxy-poliéster.

**QUICK INFO**

**GENERAL**

Recessed  
 IP40 (Optic)  
 IP20  
 650°C  
 Class I  
 Ta= -20°C +35°C

**OPTIC**

Opal PMMA  
 Micro Prismatic PMMA - UGR <19

**LED**

Efficacy up to 165 lm/W  
 3000 K, 4000 K  
 CRI >80  
 Lifetime 60 000 H  
 L80/B10 @Tc=65°C

**ELECTRICAL SYSTEM**

230V/50Hz  
 ON/OFF, DALI

**FINISHING**

RAL 9003 Matt White

**OPTIONS**

**LED**

2700 K, 5000 K, 6500 K  
 Tunable White, RGB, RGBW  
 CRI >90

**ELECTRICAL SYSTEM**

DSI, DIM 1-10V, Phase-cut

**CONTROL SYSTEM**

Bluetooth

**FINISHING**

 Other Colours

**EMERGENCY**

1 Hour, 3 Hours  
 DALI 1 Hour, 2 Hours

**SENSORS**

Motion  
 Ambient Light  
 Motion & Ambient Light

**ADAAR IP40 RECESSED**

**OPAL DIFFUSER**

bxc (mm)	Output (lm)	System (W)	ON/OFF	DALI
<b>3000 K</b>				
595x595	3116	32	33.23.002.08.26	33.23.002.08.30
	4264	47	33.23.002.08.27	33.23.002.08.31
295x1195	3967	40	33.23.002.08.28	33.23.002.08.32
	5320	57	33.23.002.08.29	33.23.002.08.33
<b>4000 K</b>				
595x595	3360	32	33.23.002.08.34	33.23.002.08.38
	4597	47	33.23.002.08.35	33.23.002.08.39
295x1195	4178	40	33.23.002.08.36	33.23.002.08.40
	5590	57	33.23.002.08.37	33.23.002.08.41

**MICRO PRISMATIC DIFFUSER - UGR <19**

bxc (mm)	Output (lm)	System (W)	ON/OFF	DALI
<b>3000 K</b>				
595x595	3024	32	33.23.002.08.42	33.23.002.08.46
	4138	47	33.23.002.08.43	33.23.002.08.47
295x1195	3855	40	33.23.002.08.44	33.23.002.08.48
	5169	57	33.23.002.08.45	33.23.002.08.49
<b>4000 K</b>				
595x595	3260	32	33.23.002.08.50	33.23.002.08.54
	4461	47	33.23.002.08.51	33.23.002.08.55
295x1195	4059	40	33.23.002.08.52	33.23.002.08.56
	5432	57	33.23.002.08.53	33.23.002.08.57

> Fluorescent lamp versions also available – product data at [www.climarlighting.com](http://www.climarlighting.com) – or by direct request to the factory.

**OPTIONS**

**EXTERNAL EMERGENCY BOX (EM) - SELF-TEST INTEGRATED**

ON/OFF	COD
EM BOX 1H 3W	35.00.004.01.56
EM BOX 3H 3W	35.00.004.01.58
DALI	COD
EM BOX 1H 5,4W DALI	35.00.004.01.57
EM BOX 3H 5,4W DALI	35.00.004.01.59

> Box dimensions: 45x120x360 mm.

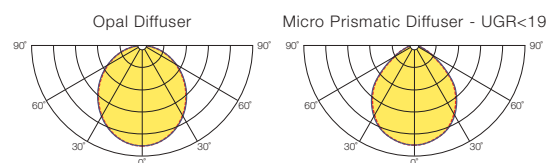
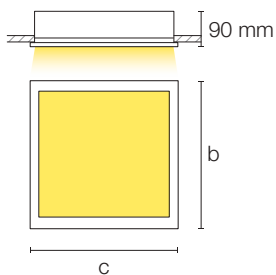

**QUICK INFO**

**GENERAL**

Recessed  
 IP44 (Optic)  
 IP20  
 650°C  
 Class I, Class II  
 Ta= -20°C +35°C

**OPTIC**

Opal PMMA

**LED**

Efficacy up to 165 lm/W  
 4000 K  
 CRI >80  
 Lifetime 60 000 H  
 L80/B10 @Tc=65°C

**ELECTRICAL SYSTEM**

230V/50Hz  
 ON/OFF, DALI

**FINISHING**

RAL 9003 Matt White

**OPTIONS**

**LED**

2700 K, 5000 K, 6500 K  
 Tunable White, RGB, RGBW  
 CRI >90

**ELECTRICAL SYSTEM**

DSI, DIM 1-10V, Phase-cut

**CONTROL SYSTEM**

Bluetooth

**FINISHING**

 Other Colours

**EMERGENCY**

1 Hour, 3 Hours  
 DALI 1 Hour, 2 Hours

**SENSORS**

Motion  
 Ambient Light  
 Motion & Ambient Light

**ADAAR IP44 RECESSED**

**OPAL DIFFUSER**

**CLASS I**

bxc (mm)	Output (lm)	System (W)	ON/OFF	DALI
<b>4000 K</b>				
295x295	1020	10	33.20.000.08.42	33.20.000.08.48
	1365	14	33.20.000.08.43	33.20.000.08.49
595x595	3360	32	33.20.000.08.44	33.20.000.08.50
	4597	47	33.20.000.08.45	33.20.000.08.51
295x1195	4178	40	33.20.000.08.46	33.20.000.08.52
	5590	57	33.20.000.08.47	33.20.000.08.53

**CLASS II**

bxc (mm)	Output (lm)	System (W)	ON/OFF	DALI
<b>4000 K</b>				
295x295	1020	10	33.20.000.08.54	33.20.000.08.61
	1365	14	33.20.000.08.55	33.20.000.08.62
595x595	3360	32	33.20.000.08.56	33.20.000.08.63
	4597	47	33.20.000.08.57	33.20.000.08.64
295x1195	4178	40	33.20.000.08.58	33.20.000.08.65
	5590	57	33.20.000.08.60	33.20.000.08.66

> Fluorescent lamp versions also available – product data at [www.climarlighting.com](http://www.climarlighting.com) – or by direct request to the factory.

**OPTIONS**

**EXTERNAL EMERGENCY BOX (EM) - SELF-TEST INTEGRATED**

ON/OFF	COD
EM BOX 1H 3W	35.00.004.01.56
EM BOX 3H 3W	35.00.004.01.58
DALI	COD
EM BOX 1H 5,4W DALI	35.00.004.01.57
EM BOX 3H 5,4W DALI	35.00.004.01.59

> Box dimensions: 45x120x360 mm.

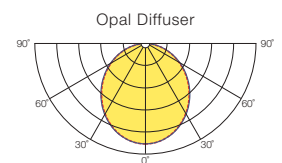
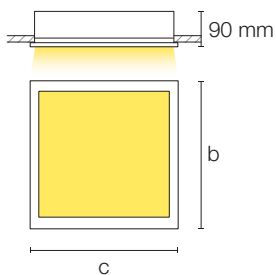



> ADAAR IP44 RECESSED

**INDI**  
RECESSED





# INDI

## RECESSED



### PT

- > Luminária de encastrar com emissão de luz indireta suave e confortável.
- > Limitação do encandeamento direto de acordo com UGR <19.
- > Aplicação em aberturas recortadas no teto ou em tetos modulares de 600x600 mm.
- > Com conjunto de niveladores para instalação rápida e sem ferramentas.
- > Proteção IP40 na face visível.
- > Refletor curvo em alumínio lacado a branco.
- > Corpo em chapa de aço com revestimento a epoxy-poliéster.

### ES

- > Luminaria con emisión de luz indirecta suave y comfortable.
- > Limitación del deslumbramiento directo según UGR <19.
- > Aplicación en huecos recortados en el techo o en techos modulares de 600x600 mm.
- > Con sistema de niveladores para el montaje rápido sin herramientas.
- > Protección IP40 en el cuerpo visible después de la instalación.
- > Reflector curvo en aluminio con recubrimiento blanco.
- > Cuerpo de chapa de acero soldada con recubrimiento epoxi-poliéster.



**QUICK INFO**

**GENERAL**

Recessed  
 IP40 (Optic)  
 IP20  
 IK07  
 650°C  
 Class I  
 Ta= -20°C +35°C

**LED**

Efficacy up to 173 lm/W  
 3000 K, 4000 K  
 CRI >80  
 Lifetime 72 000 H  
 L80/B10 @TC=65°C

**ELECTRICAL SYSTEM**

230V/50Hz  
 ON/OFF, DALI

**FINISHING**

RAL 9003 Matt White

**INDI RECESSED**

Output (lm)	System (W)	ON/OFF	DALI
<b>3000 K</b>			
1218	25	33.73.025.08.00	33.73.025.08.02
2007	40	33.73.039.08.00	33.73.039.08.02
<b>4000 K</b>			
1275	25	33.73.025.08.01	33.73.025.08.03
2100	40	33.73.039.08.01	33.73.039.08.03

**OPTIONS**

**EXTERNAL EMERGENCY BOX (EM) - SELF-TEST INTEGRATED**



ON/OFF	COD
EM BOX 1H 3W	35.00.004.01.56
EM BOX 3H 3W	35.00.004.01.58
DALI	COD
EM BOX 1H 5,4W DALI	35.00.004.01.57
EM BOX 3H 5,4W DALI	35.00.004.01.59

> Box dimensions: 45x120x360 mm.

**OPTIONS**

**LED**

2700 K, 5000 K, 6500 K  
 Tunable White, RGB, RGBW  
 CRI >90

**ELECTRICAL SYSTEM**

DSI, DIM 1-10V, Phase-cut

**CONTROL SYSTEM**

Bluetooth

**FINISHING**

Other Colours

**EMERGENCY**

1 Hour, 3 Hours  
 DALI 1 Hour, 3 Hours

**SENSORS**

Motion  
 Ambient Light  
 Motion & Ambient Light

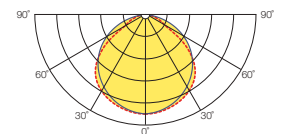
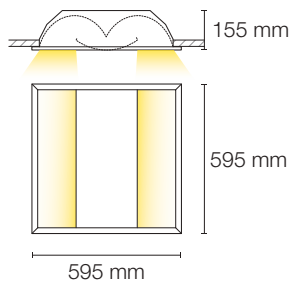

**ADAS WD**  
SURFACE





> ADAS 3WD SURFACE

# ADAS WD

## SURFACE



### PT

- > Luminária de luz homogénea com emissão direta do fluxo luminoso.
- > Aplicação saliente no teto.
- > Versões de dois (2WD) ou três (3WD) elementos óticos com difusor PMMA Opal, ou em opção com difusor Microprismático.
- > Corpo em chapa de aço com revestimento a epoxy-poliéster.

### ES

- > Luminaria de luz homogénea con emisión directa del flujo luminoso.
- > Para el montaje directo en el techo.
- > Versiones de dos (2WD) o tres (3WD) elementos óticos con difusor PMMA Opal o en opción con difusor Microprismático.
- > Cuerpo en chapa de acero con recubrimiento epoxy-poliéster.

**QUICK INFO**

**GENERAL**

Surface  
 IP40  
 650°C  
 Class I  
 Ta= -20°C +35°C

**OPTIC**

Opal PMMA

**LED**

Efficacy up to 181 lm/W  
 3000 K, 4000 K  
 CRI >80  
 Lifetime 72 000 H  
 L80/B10 @TC=65°C

**ELECTRICAL SYSTEM**

230V/50Hz  
 ON/OFF, DALI

**FINISHING**

RAL 9003 Matt White

**OPTIONS**

**OPTIC**

Micro Prismatic PMMA - UGR <19

**LED**

2700 K, 5000 K, 6500 K  
 Tunable White, RGB, RGBW  
 CRI >90

**ELECTRICAL SYSTEM**

DSI, DIM 1-10V, Phase-cut

**CONTROL SYSTEM**

Bluetooth

**FINISHING**

Other Colours

**EMERGENCY**

1 Hour, 3 Hours  
 DALI 1 Hour, 3 Hours

**SENSORS**

Motion  
 Ambient Light  
 Motion & Ambient Light

**ADAS WD SURFACE**

**OPAL DIFFUSER**

**2WD**

Output (lm)	System (W)	ON/OFF	DALI
<b>3000 K</b>			
2507	25	33.55.000.08.06	33.55.000.08.10
3352	32	33.55.000.08.07	33.55.000.08.11
<b>4000 K</b>			
2624	38	33.55.000.08.14	33.55.000.08.18
3509	48	33.55.000.08.15	33.55.000.08.19

**3WD**

Output (lm)	System (W)	ON/OFF	DALI
<b>3000 K</b>			
3822	25	33.55.000.08.08	33.55.000.08.12
5111	32	33.55.000.08.09	33.55.000.08.13
<b>4000 K</b>			
4000	38	33.55.000.08.16	33.55.000.08.20
5349	48	33.55.000.08.17	33.55.000.08.21

**OPTIONS**

**EMERGENCY (EM) - SELF-TEST INTEGRATED**

ON/OFF	COD
EM 1H 3W	35.00.003.01.23
EM 3H 3W	35.00.003.01.24

DALI	COD
EM 1H 5,4W DALI	35.00.004.01.54
EM 3H 5,4W DALI	35.00.004.01.55

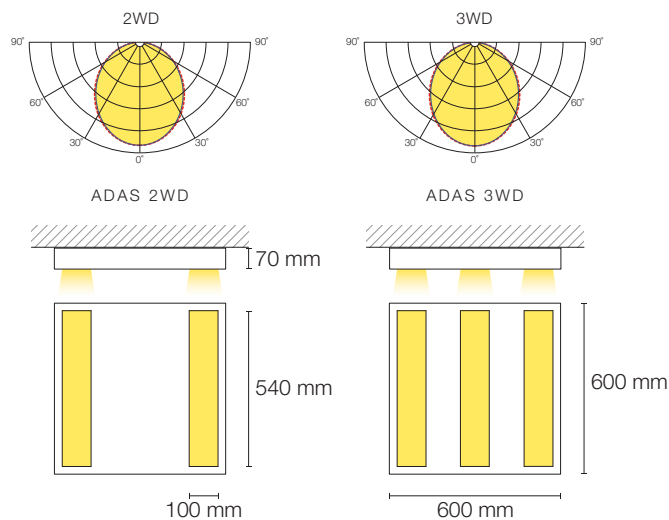

**CISTUS**  
SURFACE





# CISTUS

## SURFACE

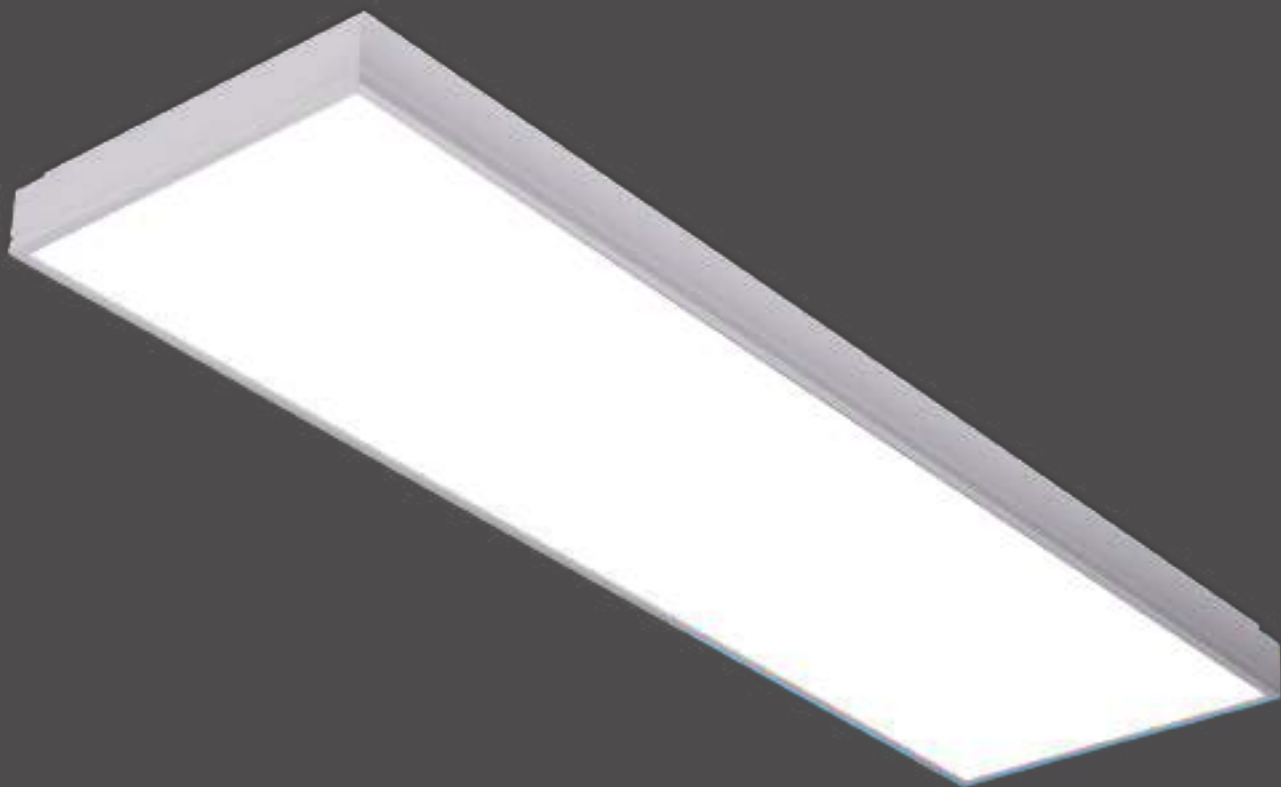

### PT

- > Luminária de luz homogénea com emissão direta do fluxo luminoso.
- > Aplicação saliente no teto.
- > Índice de proteção IP40.
- > Difusor Policarbonato Opal para iluminação homogénea, difusa e com elevada eficiência.
- > Corpo em perfil de alumínio extrudido.

### ES

- > Luminaria de luz homogénea con emisión directa del flujo luminoso.
- > Para el montaje directo en el techo.
- > Grado de protección IP40.
- > Difusor Policarbonato Opal.
- > Cuerpo en perfil de aluminio extruido.



## QUICK INFO

## GENERAL

Surface  
IP40  
IK07  
850°C  
Class I  
Ta= -20°C +35°C

## OPTIC

Opal Polycarbonate

## LED

Efficacy up to 180 lm/W  
3000 K, 4000 K  
CRI >80  
Lifetime 60 000 H  
L80/B10 @Tc=65°C

## ELECTRICAL SYSTEM

230V/50Hz  
ON/OFF, DALI

## FINISHING

RAL 9003 Matt White  
Matt Anodized

## OPTIONS

## LED

2700 K, 5000 K, 6500 K  
Tunable White, RGB, RGBW  
CRI >90

## ELECTRICAL SYSTEM

DSI, DIM 1-10V, Phase-cut

## CONTROL SYSTEM

Bluetooth

## FINISHING

 Other Colours

## EMERGENCY

1 Hour, 3 Hours  
DALI 1 Hour, 3 Hours

## SENSORS

Motion  
Ambient Light  
Motion & Ambient Light

## CISTUS SURFACE

## OPAL DIFFUSER

## MATT WHITE FINISHING

bx c (mm)	Output (lm)	System (W)	ON/OFF	DALI
<b>3000 K</b>				
340x340	734	6,7	33.41.22.000061	33.41.22.000073
	1248	12	33.41.22.000062	33.41.22.000074
600x600	2937	27	33.41.22.000063	33.41.22.000075
	4992	48	33.41.22.000064	33.41.22.000076
340x1160	2830	27	33.41.22.000065	33.41.22.000077
	4811	48	33.41.22.000066	33.41.22.000078
<b>4000 K</b>				
340x340	778	6,7	33.41.22.000085	33.41.22.000097
	1329	12	33.41.22.000086	33.41.22.000098
600x600	3113	27	33.41.22.000087	33.41.22.000099
	6215	48	33.41.22.000088	33.41.22.000100
340x1160	3000	27	33.41.22.000089	33.41.22.000101
	5123	48	33.41.22.000090	33.41.22.000102

## MATT ANODIZED FINISHING

bx c (mm)	Output (lm)	System (W)	ON/OFF	DALI
<b>3000 K</b>				
340x340	734	6,7	33.41.22.000067	33.41.22.000079
	1248	12	33.41.22.000068	33.41.22.000080
600x600	2937	27	33.41.22.000069	33.41.22.000081
	4992	48	33.41.22.000070	33.41.22.000082
340x1160	2830	27	33.41.22.000071	33.41.22.000083
	4811	48	33.41.22.000072	33.41.22.000084
<b>4000 K</b>				
340x340	778	6,7	33.41.22.000091	33.41.22.000103
	1329	12	33.41.22.000092	33.41.22.000104
600x600	3113	27	33.41.22.000093	33.41.22.000105
	6215	48	33.41.22.000094	33.41.22.000106
340x1160	3000	27	33.41.22.000095	33.41.22.000107
	5123	48	33.41.22.000096	33.41.22.000108

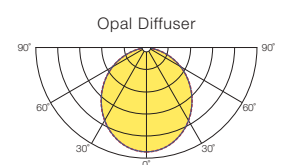
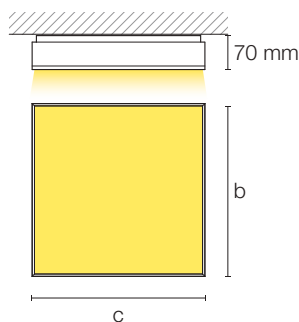

**ERGOS**  
SURFACE





# ERGOS IP40, IP65

## SURFACE



### PT

- > Perfil compacto e eficiente para iluminação em prateleiras e mobiliário, sancas e superfícies de trabalho.
- > Adequado para aplicação saliente no teto ou na parede.
- > Versão ERGOS-L com ângulo de abertura de 120° e proteção IP40 ou IP65.
- > Versão ERGOS-H fornecido com abertura de 80°, ajustável para 30° ou 54° em obra. Índice de proteção IP40.
- > Sistema de clipagem permite instalação rápida com apenas um clique.
- > Driver externo de tensão constante e classe de proteção II.
- > Difusor Policarbonato Opal e corpo em perfil de alumínio anodizado mate.

### ES

- > Perfil compacto y eficiente para iluminación en estanterías y muebles, en techos abovedados o en superficies de trabajo.
- > Apropriado para aplicación en superficie en el techo o pared.
- > Versión ERGOS-L con ángulo de emisión de 120° y protección IP40 o IP65.
- > Versión ERGOS-H suministrada con emisión de 80°, ajustable para 30° o 54° en obra. Grado de protección IP40.
- > Sistema de clipaje permite una instalación rápida con un simple clic.
- > Driver externo de tensión constante y clase de protección II.
- > Difusor Policarbonato Opal y cuerpo en perfil de aluminio anodizado mate.

**QUICK INFO**

**GENERAL**

Surface / Wall  
 IP40, IP65  
 IK06  
 850°C  
 Class III  
 Ta= -20°C +35°C

**OPTIC**

Opal Polycarbonate

**LED**

Efficacy up to 103 lm/W  
 2700 K, 3000 K, 4000 K  
 CRI >80  
 Lifetime 50 000 H  
 L70/B10 @Tc=65°C  
 24 VDC

**ELETRICAL SYSTEM**

230V/50Hz  
 ON/OFF, DALI

**FINISHING**

Matt Anodized

**OPTIONS**

**LED**

5000 K, 6500 K  
 Tunable White, RGB, RGBW  
 CRI >90

**ELECTRICAL SYSTEM**

DSI, DIM 1-10V

**CONTROL SYSTEM**

Bluetooth

**FINISHING**

 Other Colours

**SENSORS**

Motion  
 Ambient Light  
 Motion & Ambient Light

**ERGOS-L SURFACE**

**OPAL DIFFUSER**

**IP40**

c (mm)	Output (lm)	LED Power (W)	LED Voltage	ANODIZED
<b>2700 K</b>				
1025	332	4,8	24 VDC	33.41.15.000807
	1085	14,4	24 VDC	33.41.15.000809
2525	829	12	24 VDC	33.41.15.000808
	2684	36	24 VDC	33.41.15.000810
<b>3000 K</b>				
1025	353	4,8	24 VDC	33.41.15.000811
	1154	14,4	24 VDC	33.41.15.000813
2525	882	12	24 VDC	33.41.15.000812
	2886	36	24 VDC	33.41.15.000814
<b>4000 K</b>				
1025	363	4,8	24 VDC	33.41.15.000815
	1075	14,4	24 VDC	33.41.15.000817
2525	908	12	24 VDC	33.41.15.000816
	2687	36	24 VDC	33.41.15.000818

**IP65**

c (mm)	Output (lm)	LED Power (W)	LED Voltage	ANODIZED
<b>2700 K</b>				
1030	332	4,8	24 VDC	33.41.15.000819
	1085	14,4	24 VDC	33.41.15.000821
2530	829	12	24 VDC	33.41.15.000820
	2684	36	24 VDC	33.41.15.000822
<b>3000 K</b>				
1030	353	4,8	24 VDC	33.41.15.000823
	1154	14,4	24 VDC	33.41.15.000825
2530	882	12	24 VDC	33.41.15.000824
	2886	36	24 VDC	33.41.15.000826
<b>4000 K</b>				
1030	363	4,8	24 VDC	33.41.15.000827
	1075	14,4	24 VDC	33.41.15.000829
2530	908	12	24 VDC	33.41.15.000828
	2687	36	24 VDC	33.41.15.000830

ERGOS L

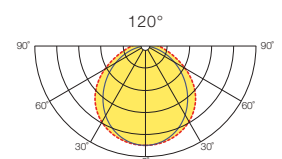
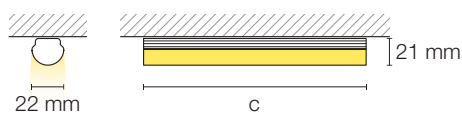

**QUICK INFO**

**GENERAL**

Surface / Wall  
 IP40  
 IK06  
 850°C  
 Class III  
 Ta= -20°C +35°C

**OPTIC**

Opal Polycarbonate

**LED**

Efficacy up to 87 lm/W  
 2700 K, 3000 K, 4000 K  
 CRI >80  
 Lifetime 50 000 H  
 L70/B10 @Tc=65°C  
 24 VDC

**ELETRICAL SYSTEM**

230V/50Hz  
 ON/OFF, DALI

**FINISHING**

Matt Anodized

**ERGOS-H SURFACE**

**OPAL DIFFUSER**

**IP40**

c (mm)	Output (lm)	LED Power (W)	LED Voltage	ANODIZED
<b>2700 K</b>				
1030	1788	24	24 VDC	33.41.15.000708
2530	4471	60	24 VDC	33.41.15.000709
<b>3000 K</b>				
1030	1927	24	24 VDC	33.41.15.000567
2530	4818	60	24 VDC	33.41.15.000570
<b>4000 K</b>				
1030	2010	24	24 VDC	33.41.15.000572
2530	5024	60	24 VDC	33.41.15.000575

**COMPONENTS**

**DRIVER - EXTERNAL**

ON/OFF	DIMENSION	COD
Power Supply 4-32W IP20	21x40x220 mm	35.00.003.01.75
Power Supply 12-86W IP20	21x40x300 mm	35.00.003.01.73
Power Supply 22-162W IP20	31x64x280 mm	35.00.003.01.72

DALI	DIMENSION	COD
Power Supply 12-90W IP20	30x43x295 mm	35.00.003.01.76
Power Supply 18-135W IP20	31x43x325 mm	35.00.003.01.77

> External Driver to be housed nearby.



CLASS II

**OPTIONS**

**LED**

5000 K, 6500 K  
 Tunable White, RGB, RGBW  
 CRI >90

**ELECTRICAL SYSTEM**

DSI, DIM 1-10V

**CONTROL SYSTEM**

Bluetooth

**FINISHING**

Other Colours

**SENSORS**

Motion  
 Ambient Light  
 Motion & Ambient Light

**ERGOS H**

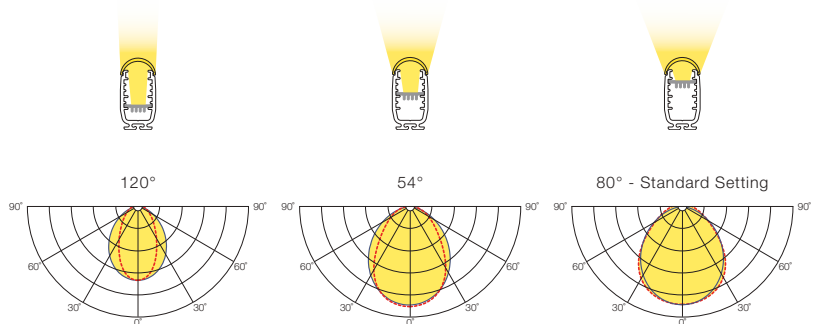
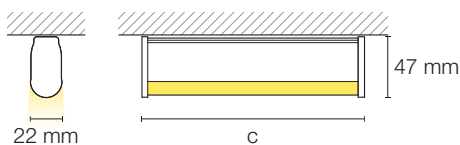



> **ERGOS-H** SURFACE

**I-SPOT**  
SURFACE







> I-SPOT 90 ORIENTABLE SURFACE

# I-SPOT

IP20, IP44

## SURFACE



### PT

- > Downlight em alumínio para aplicação saliente no teto.
- > Formato tubular disponível em três diâmetros distintos.
- > Fonte de luz recuada que proporciona maior sensação de conforto visual.
- > Corpo em alumínio com revestimento a epoxy-poliéster.

### ES

- > Downlight en aluminio para aplicación adosada a techo.
- > Formato tubular disponible en tres diámetros.
- > Posición reculada de la fuente de luz proporcionando una mayor sensación de confort visual.
- > Cuerpo en aluminio con recubrimiento epoxi-poliéster.

**QUICK INFO**

**GENERAL**

Surface  
 IP20, IP44  
 960°C  
 Class I  
 Ta= -20°C +35°C

**LAMP - NOT INCLUDED**

E27  
 (PAR20 / PAR30S / PAR38)

**ELECTRICAL SYSTEM**

230V/50Hz  
 ON/OFF

**FINISHING**

RAL 9003 Matt White  
 RAL 9005 Matt Black

**I-SPOT SURFACE - LAMP**

**IP20**

Ø (mm)	Type	h (mm)	LAMP		
			Power (W)	MATT WHITE	MATT BLACK
<b>E27</b>					
100	PAR20	165	max. 50	33.92.050.01.24	33.92.050.01.27
		200	max. 50	33.92.050.01.25	33.92.050.01.28
		250	max. 50	33.92.050.01.26	33.92.050.01.29
120	PAR30S	170	max. 50	33.92.050.01.30	33.92.050.01.33
		200	max. 50	33.92.050.01.31	33.92.050.01.34
		250	max. 50	33.92.050.01.32	33.92.050.01.35
150	PAR38	210	max. 50	33.92.050.01.36	33.92.050.01.39
		250	max. 50	33.92.050.01.37	33.92.050.01.40
		300	max. 50	33.92.050.01.38	33.92.050.01.41

> Lamp not included.

**OPTIONS**

**CONTROL SYSTEM**

Bluetooth

**FINISHING**

Other Colours

**SENSORS**

Motion

**IP44**

Ø (mm)	Type	h (mm)	LAMP		
			Power (W)	MATT WHITE	MATT BLACK
<b>E27</b>					
100	PAR20	165	max. 50	33.92.050.01.06	33.92.050.01.09
		200	max. 50	33.92.050.01.07	33.92.050.01.10
		250	max. 50	33.92.050.01.08	33.92.050.01.11
120	PAR30S	170	max. 50	33.92.050.01.12	33.92.050.01.15
		200	max. 50	33.92.050.01.13	33.92.050.01.16
		250	max. 50	33.92.050.01.14	33.92.050.01.17
150	PAR38	210	max. 50	33.92.050.01.18	33.92.050.01.21
		250	max. 50	33.92.050.01.19	33.92.050.01.22
		300	max. 50	33.92.050.01.20	33.92.050.01.23

> Lamp not included.

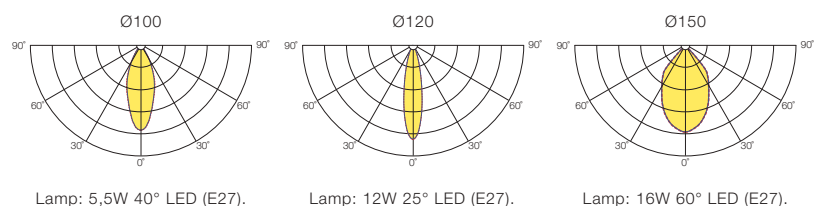
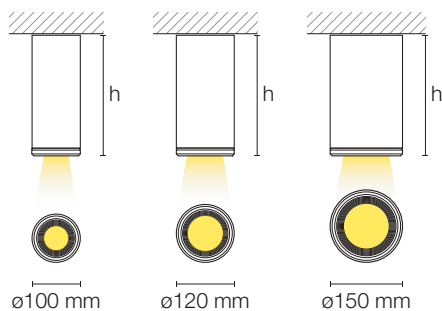

# I-SPOT ORIENTABLE

## SURFACE



### PT

- > Downlight em alumínio com foco orientável em dois eixos.
- > De aplicação saliente no teto.
- > Formato tubular diâmetro 90 mm disponível em três alturas distintas.
- > Corpo em alumínio com revestimento a epoxy-poliéster.

### ES

- > Downlight en aluminio con proyector orientable en dos ejes.
- > Para aplicación adosada a techo.
- > Formato tubular diámetro 90 mm disponible en tres alturas.
- > Cuerpo en aluminio con recubrimiento epoxi-poliéster.

**QUICK INFO**

**GENERAL**

Surface  
 IP20  
 960°C  
 Class I  
 Ta= -20°C +35°C

**LAMP** - NOT INCLUDED  
 GU10 (PAR16)

**ELETRICAL SYSTEM**

230V/50Hz  
 ON/OFF

**FINISHING**

RAL 9003 Matt White  
 RAL 9005 Matt Black

**OPTIONS**

**CONTROL SYSTEM**

Bluetooth

**FINISHING**

 Other Colours

**SENSORS**

Motion

**I-SPOT 90 ORIENTABLE SURFACE - LAMP**

**IP20**

Type	h (mm)	LAMP Power (W)	MATT WHITE	MATT BLACK
			GU10	GU10
	120	max. 50	33.16.000.01.18	33.16.000.01.19
PAR16	180	max. 50	33.16.000.01.20	33.16.000.01.21
	250	max. 50	33.16.000.01.22	33.16.000.01.23

> Lamp not included.

**RECOMENDED LAMPS**



**OSRAM**  
 PARATHOM  
 PAR 16  
 GU10  
 6,9 W



**PHILIPS**  
 Corepro  
 LEDspot  
 GU10  
 7 W

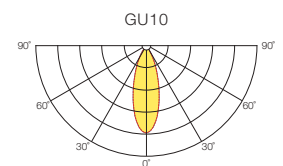
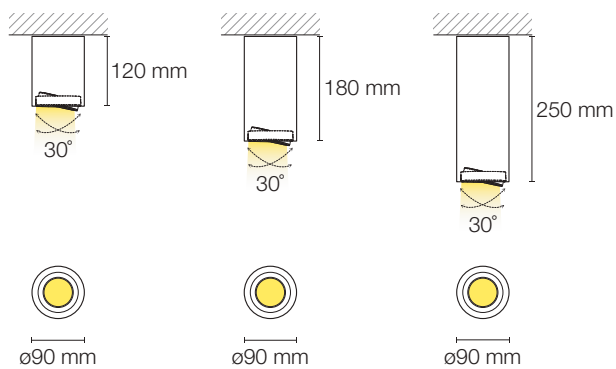
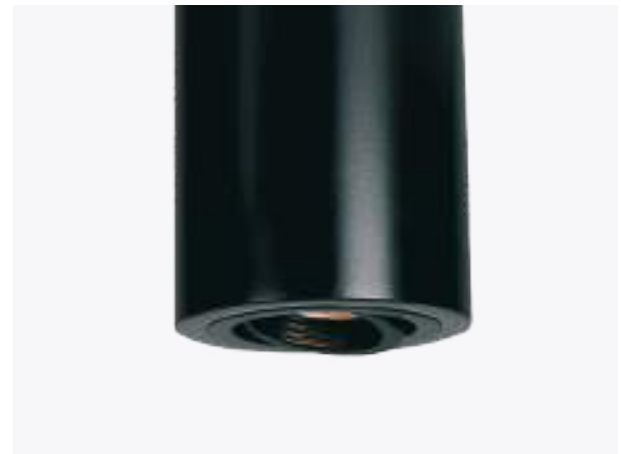

Lamp: 5W 40° LED (GU10).

# I-SPOT RO IP40, IP44

## SURFACE



### PT

- > Downlight em alumínio para aplicação saliente no teto.
- > Formato tubular diâmetro 150 mm disponível em duas alturas distintas.
- > Difusor Policarbonato Opal para iluminação homogénea, difusa e eficiente.
- > Corpo em alumínio com revestimento a epoxy-poliéster.

### ES

- > Downlight en aluminio para aplicación adosada a techo.
- > Formato tubular diámetro 150 mm disponible en dos alturas.
- > Difusor Policarbonato Opal.
- > Cuerpo en aluminio con recubrimiento epoxy-poliéster.

**QUICK INFO**

**GENERAL**

Surface  
 IP40, IP44  
 850°C  
 Class I  
 Ta= -20°C +35°C

**OPTIC**

Opal Polycarbonate

**LED**

Efficacy up to 153 lm/W  
 3000 K, 4000 K  
 CRI >80  
 Lifetime 60 000 H  
 L80/B10 @TC=65°C

**ELECTRICAL SYSTEM**

230V/50Hz  
 ON/OFF

**FINISHING**

RAL 9003 Matt White  
 RAL 9005 Matt Black

**I-SPOT 150 RO SURFACE  
 OPAL DIFFUSER**

**IP40**

h (mm)	Output (lm)	System (W)	MATT WHITE	MATT BLACK
<b>3000 K</b>				
120	860	12	33.16.000.08.36	33.16.000.08.37
150	860	12	33.16.000.08.40	33.16.000.08.41
<b>4000 K</b>				
120	919	12	33.16.000.08.38	33.16.000.08.39
150	919	12	33.16.000.08.42	33.16.000.08.43

**IP44**

h (mm)	Output (lm)	System (W)	MATT WHITE	MATT BLACK
<b>3000 K</b>				
120	860	12	33.16.000.08.52	33.16.000.08.53
150	860	12	33.16.000.08.56	33.16.000.08.57
<b>4000 K</b>				
120	919	12	33.16.000.08.54	33.16.000.08.55
150	919	12	33.16.000.08.58	33.16.000.08.59

**OPTIONS**

**LED**

2700 K, 5000 K, 6500 K

**ELECTRICAL SYSTEM**

DALI, DSI, DIM 1-10V, Phase-cut

**CONTROL SYSTEM**

Bluetooth

**FINISHING**

Other Colours

**EMERGENCY**

1 Hour, 3 Hours  
 DALI 1 Hour, 3 Hours

**SENSORS**

Motion  
 Ambient Light  
 Motion & Ambient Light

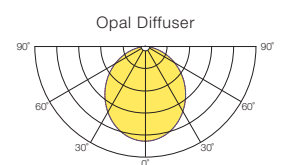
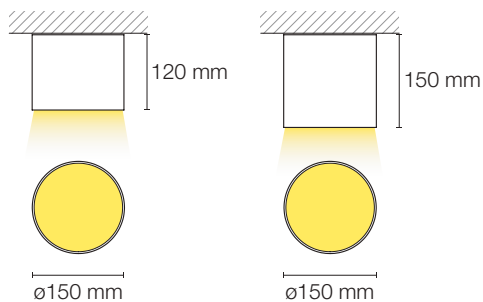

# I-SPOT SQ

## SURFACE



### PT

- > Downlight em alumínio para aplicação saliente no teto.
- > Formato quadrado com 150x150 mm disponível em duas alturas distintas.
- > Difusor Policarbonato Opal para iluminação homogénea, difusa e eficiente.
- > Corpo em alumínio com revestimento a epoxy-poliéster.

### ES

- > Downlight en aluminio para aplicación adosada a techo.
- > Formato cuadrado con 150x150 mm disponible en dos alturas.
- > Difusor Policarbonato Opal.
- > Cuerpo en aluminio con recubrimiento epoxy-poliéster.



**QUICK INFO**

**GENERAL**

Surface  
 IP40  
 850°C  
 Class I  
 Ta= -20°C +35°C

**OPTIC**

Opal Polycarbonate

**LED**

Efficacy up to 153 lm/W  
 3000 K, 4000 K  
 CRI >80  
 Lifetime 60 000 H  
 L80/B10 @TC=65°C

**ELECTRICAL SYSTEM**

230V/50Hz  
 ON/OFF

**FINISHING**

RAL 9003 Matt White  
 RAL 9005 Matt Black

**OPTIONS**

**LED**

2700 K, 5000 K, 6500 K

**ELECTRICAL SYSTEM**

DALI, DSI, DIM 1-10V, Phase-cut

**CONTROL SYSTEM**

Bluetooth

**FINISHING**

Other Colours

**EMERGENCY**

1 Hour, 3 Hours  
 DALI 1 Hour, 3 Hours

**SENSORS**

Motion  
 Ambient Light  
 Motion & Ambient Light

**I-SPOT 150 SQ SURFACE  
 OPAL DIFFUSER**

**IP40**

h (mm)	Output (lm)	System (W)	MATT WHITE	MATT BLACK
<b>3000 K</b>				
100	876	12	33.16.000.08.44	33.16.000.08.46
150	876	12	33.16.000.08.48	33.16.000.08.50
<b>4000 K</b>				
100	937	12	33.16.000.08.45	33.16.000.08.47
150	937	12	33.16.000.08.49	33.16.000.08.51

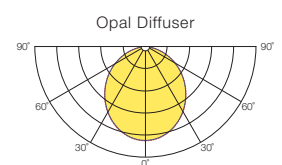
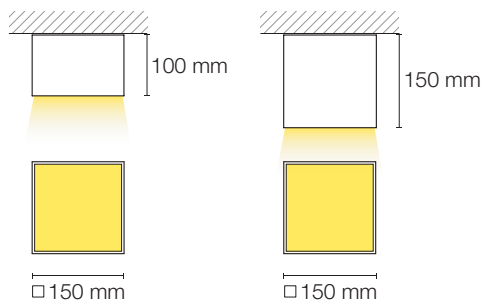

**TALLES**  
RECESSED





# TALLES 30 RO IN

## RECESSED



### PT

- > Downlight compacto para aplicação encastrada.
- > Fonte de luz recuada que evita o encandeamento e proporciona maior sensação de conforto visual.
- > Duas opções de lente – ângulo de abertura 25° ou 40°.
- > Com molas de fixação rápida para instalação sem ferramentas.
- > Adequado para instalação em tetos falsos com espessura entre 5 e 20 mm.
- > Driver externo de corrente constante e classe proteção II.
- > Corpo em alumínio com revestimento a epoxy-poliéster.

### ES

- > Downlight compacto para aplicación empotrada.
- > La posición reculada del LED evita el deslumbramiento, proporcionando una mayor sensación de confort visual.
- > Dos opciones de lente - ángulo de apertura 25° o 40°.
- > Con muelles de montaje rápido sin ayuda de herramientas.
- > Adecuado para la instalación en falsos techos con espesor entre 5 y 20 mm.
- > Driver externo de corriente constante y clase de protección II.
- > Cuerpo en aluminio con recubrimiento epoxi-poliéster.

**QUICK INFO**

**GENERAL**

Recessed  
 IP43 (Optic)  
 IP30  
 IK04  
 650°C  
 Class III  
 Ta= -20°C +35°C

**OPTIC**

PMMA Lens

**LED**

Efficacy up to 150 lm/W  
 3000 K, 5000 K  
 CRI >80  
 Lifetime 50 000 H  
 L80/B10 @Tc=65°C  
 350 mA, 700 mA

**ELECTRICAL SYSTEM**

230V/50Hz  
 ON/OFF, DALI

**FINISHING**

RAL 9003 Matt White  
 RAL 9005 Matt Black

**OPTIONS**

**LED**

2700 K, 4000 K, 6500 K  
 CRI >90

**ELECTRICAL SYSTEM**

DSI, DIM 1-10V, Phase-cut

**CONTROL SYSTEM**

Bluetooth

**FINISHING**

 Other Colours

**EMERGENCY**

1 Hour, 3 Hours  
 DALI 1 Hour, 3 Hours

**SENSORS**

Motion  
 Ambient Light  
 Motion & Ambient Light

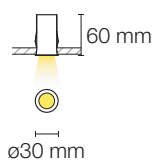

**TALLES 30 RO IN RECESSED**

Beam Angle (°)	Output (lm)	LED Power (W)	LED Current	MATT WHITE	MATT BLACK
<b>3000 K</b>					
25°	56	1,2	350 mA	33.92.005.08.14	33.92.005.08.16
	89	2,5	700 mA	33.92.006.08.66	33.92.006.08.67
40°	53	1,2	350 mA	33.92.005.08.18	33.92.005.08.20
	85	2,5	700 mA	33.92.006.08.68	33.92.006.08.69
<b>5000 K</b>					
25°	62	1,2	350 mA	33.92.005.08.19	33.92.005.08.21
	100	2,5	700 mA	33.92.006.08.70	33.92.006.08.71
40°	59	1,2	350 mA	33.92.005.08.15	33.92.005.08.17
	94	2,5	700 mA	33.92.006.08.72	33.92.006.08.73

**COMPONENTS**

**DRIVER - EXTERNAL**



CLASS II

ON/OFF	Current	DIMENSION	COD
Power Supply 1-5W IP20	350 mA	22x32x76 mm	35.92.00.000023
Power Supply 2-7W IP20	700 mA	23x32x76 mm	35.92.00.000024
DALI	Current	DIMENSION	COD
Power Supply 1-13W IP20	350 mA	22x52x111 mm	35.92.00.000025
Power Supply 2-17W IP20	700 mA	22x52x111 mm	35.92.00.000026

> External Driver to be housed nearby.

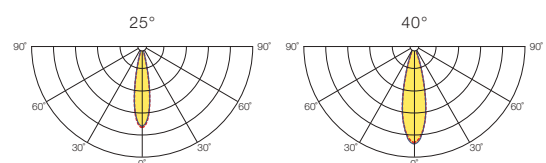

# TALLES 35 RO IP44

## RECESSED



### PT

- > Downlight compacto para aplicação encastrada.
- > Três opções de lente – ângulo de abertura 10°, 25° ou 40°.
- > Com molas de fixação rápida para instalação sem ferramentas.
- > Adequado para instalação em tetos falsos com espessura entre 5 e 20 mm.
- > Driver externo de corrente constante e classe proteção II.
- > Corpo e aro de remate em alumínio com revestimento a epoxy-poliéster.

### ES

- > Downlight compacto para aplicación empotrada.
- > Tres opciones de lente - ángulo de apertura 10°, 25° o 40°.
- > Con muelles de montaje rápido sin ayuda de herramientas.
- > Adecuado para la instalación en falsos techos con espesor entre 5 y 20 mm.
- > Driver externo de corriente constante y clase de protección II.
- > Cuerpo y aro frontal en aluminio con recubrimiento epoxi-poliéster.

**QUICK INFO**

**GENERAL**

Recessed  
 IP44 (Optic)  
 IP30  
 IK04  
 650°C  
 Class III  
 Ta= -20°C +35°C

**OPTIC**

PMMA Lens

**LED**

Efficacy up to 135 lm/W  
 3000 K, 4000 K  
 CRI >80  
 Lifetime 50 000 H  
 L80/B10 @Tc=65°C  
 350 mA, 700 mA

**ELECTRICAL SYSTEM**

230V/50Hz  
 ON/OFF, DALI

**FINISHING**

RAL 9003 Matt White  
 RAL 9005 Matt Black

**OPTIONS**

**LED**

2700 K, 5000 K, 6500 K  
 CRI >90

**ELECTRICAL SYSTEM**

DSI, DIM 1-10V, Phase-cut

**CONTROL SYSTEM**

Bluetooth

**FINISHING**

Other Colours

**EMERGENCY**

1 Hour, 3 Hours  
 DALI 1 Hour, 3 Hours

**SENSORS**

Motion  
 Ambient Light  
 Motion & Ambient Light

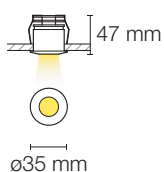

**TALLES 35 RO RECESSED**

**IP44**

Beam Angle (°)	Output (lm)	LED Power (W)	LED Current	MATT WHITE	MATT BLACK
<b>3000 K</b>					
10°	86	1,2	350 mA	33.92.004.08.82	33.92.004.08.96
	167	2,5	700 mA	33.92.004.08.83	33.92.004.08.97
25°	101	1,2	350 mA	33.92.004.08.84	33.92.004.08.98
	196	2,5	700 mA	33.92.004.08.85	33.92.004.08.99
40°	98	1,2	350 mA	33.92.004.08.86	33.92.005.08.00
	191	2,5	700 mA	33.92.004.08.87	33.92.005.08.01
<b>4000 K</b>					
10°	95	1,2	350 mA	33.92.004.08.88	33.92.005.08.02
	185	2,5	700 mA	33.92.004.08.89	33.92.005.08.03
25°	111	1,2	350 mA	33.92.004.08.90	33.92.005.08.04
	216	2,5	700 mA	33.92.004.08.91	33.92.005.08.05
40°	108	1,2	350 mA	33.92.004.08.92	33.92.005.08.06
	210	2,5	700 mA	33.92.004.08.93	33.92.005.08.07

**COMPONENTS**

**DRIVER - EXTERNAL**



CLASS II

**ON/OFF**

ON/OFF	Current	DIMENSION	COD
Power Supply 1-5W IP20	350 mA	22x32x76 mm	35.92.00.000023
Power Supply 2-7W IP20	700 mA	23x32x76 mm	35.92.00.000024

**DALI**

DALI	Current	DIMENSION	COD
Power Supply 1-13W IP20	350 mA	22x52x111 mm	35.92.00.000025
Power Supply 2-17W IP20	700 mA	22x52x111 mm	35.92.00.000026

> External Driver to be housed nearby.

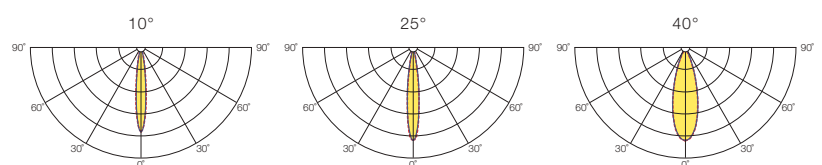

# TALLES 42 RO IP65

## RECESSED



### PT

- > Downlight compacto para aplicação encastrada com elevado grau de proteção (IP65).
- > Três opções de lente – ângulo de abertura 10°, 25° ou 40°.
- > Com molas de fixação rápida para instalação sem ferramentas.
- > Adequado para instalação em tetos falsos com espessura entre 5 e 20 mm.
- > Driver externo de corrente constante e classe proteção II.
- > Corpo e aro de remate em alumínio com revestimento a epoxy-poliéster.

### ES

- > Downlight compacto para aplicación empotrada con elevado grado de protección (IP65).
- > Tres opciones de lente - ángulo de apertura 10°, 25° o 40°.
- > Con muelles de montaje rápido sin ayuda de herramientas.
- > Adecuado para la instalación en falsos techos con espesor entre 5 y 20 mm.
- > Driver externo de corriente constante y clase de protección II.
- > Cuerpo y aro frontal en aluminio con recubrimiento epoxi-poliéster.



**QUICK INFO**

**GENERAL**

Recessed  
 IP65 (Optic)  
 IP30  
 IK07  
 960°C  
 Class III  
 Ta= -20°C +35°C

**OPTIC**

Clear Glass  
 PMMA Lens

**LED**

Efficacy up to 135 lm/W  
 3000 K, 4000 K  
 CRI >80  
 Lifetime 50 000 H  
 L80/B10 @Tc=65°C

**ELECTRICAL SYSTEM**

230V/50Hz  
 ON/OFF, DALI

**FINISHING**

RAL 9003 Matt White  
 RAL 9005 Matt Black

**TALLES 42 RO RECESSED**

**IP65**

Beam Angle (°)	Output (lm)	LED Power (W)	MATT WHITE	MATT BLACK
<b>3000 K</b>				
10°	167	2,5	33.92.004.08.76	33.92.005.08.08
25°	196	2,5	33.92.004.08.77	33.92.005.08.09
40°	191	2,5	33.92.004.08.78	33.92.005.08.10
<b>4000 K</b>				
10°	185	2,5	33.92.004.08.79	33.92.005.08.11
25°	216	2,5	33.92.004.08.80	33.92.005.08.12
40°	210	2,5	33.92.004.08.81	33.92.005.08.13

**COMPONENTS**

**DRIVER - EXTERNAL**



CLASS II

**ON/OFF**

	DIMENSION	COD
Power Supply 2-7W IP20	22x32x76 mm	35.92.00.000024

**DALI**

	DIMENSION	COD
Power Supply 2-17W IP20	23x52x111 mm	35.92.00.000026

> External Driver to be housed nearby.

**OPTIONS**

**LED**

2700 K, 5000 K, 6500 K  
 Tunable White, RGB, RGBW  
 CRI >90

**ELECTRICAL SYSTEM**

DSI, DIM 1-10V, Phase-cut

**CONTROL SYSTEM**

Bluetooth

**FINISHING**

Other Colours

**EMERGENCY**

1 Hour, 3 Hours  
 DALI 1 Hour, 3 Hours

**SENSORS**

Motion  
 Ambient Light  
 Motion & Ambient Light

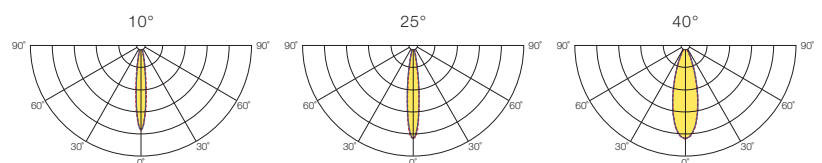
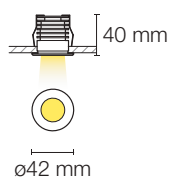

# TALLES 70 RO IP20, IP44

## RECESSED



### PT

- > Downlight compacto com aro circular para aplicação encastrada.
- > Disponível em versões IP20 ou com proteção IP44 equipada com difusor em vidro temperado.
- > Três opções de lente – ângulo de abertura 20°, 35° ou 55°.
- > Com molas de fixação rápida para instalação sem ferramentas.
- > Adequado para instalação em tetos falsos com espessura entre 1 e 15 mm.
- > Driver externo de corrente constante e classe proteção II.
- > Aro de remate em alumínio com revestimento a epoxy-poliéster.

### ES

- > Downlight compacto con aro circular para aplicación empotrada.
- > Disponible en versiones IP20 o con protección IP44 con difusor en vidrio templado.
- > Tres opciones de lente - ángulo de apertura 20°, 35° o 55°.
- > Con muelles de montaje rápido sin ayuda de herramientas.
- > Adecuado para la instalación en falsos techos con espesor entre 1 y 15 mm.
- > Driver externo de corriente constante y clase de protección II.
- > Aro frontal en aluminio con recubrimiento epoxi-poliéster.

**QUICK INFO**

**GENERAL**

Recessed  
 IP20  
 650°C  
 Class III  
 Ta= -20°C +35°C

**OPTIC**

Clear PMMA

**LED**

Efficacy up to 170 lm/W  
 3000 K, 4000 K  
 CRI >80  
 Lifetime 72 000 H  
 L80/B10 @TC=65°C  
 150 mA, 200 mA, 250 mA

**ELECTRICAL SYSTEM**

230V/50Hz  
 ON/OFF, DALI

**FINISHING**

RAL 9003 Matt White  
 RAL 9005 Matt Black

**OPTIONS**

**LED**

2700 K  
 CRI >90

**ELECTRICAL SYSTEM**

DSI, DIM 1-10V, Phase-cut

**CONTROL SYSTEM**

Bluetooth

**FINISHING**

Other Colours

**EMERGENCY**

1 Hour, 3 Hours  
 DALI 1 Hour, 3 Hours

**SENSORS**

Motion  
 Ambient Light  
 Motion & Ambient Light

**TALLES 70 RO RECESSED**

**IP20**

Beam Angle (°)	Output (lm)	LED Power (W)	LED Current	MATT WHITE	MATT BLACK
<b>3000 K</b>					
20°	654	5	150 mA	33.92.005.08.95	33.92.005.08.94
	838	7	200 mA	33.92.005.08.97	33.92.005.08.96
	1012	8,7	250 mA	33.92.005.08.99	33.92.005.08.98
35°	628	5	150 mA	33.92.006.08.01	33.92.006.08.00
	805	7	200 mA	33.92.006.08.03	33.92.006.08.02
	972	8,7	250 mA	33.92.006.08.05	33.92.006.08.04
55°	639	5	150 mA	33.92.006.08.07	33.92.006.08.06
	819	7	200 mA	33.92.006.08.09	33.92.006.08.08
	989	8,7	250 mA	33.92.006.08.11	33.92.006.08.10
<b>4000 K</b>					
20°	814	5	150 mA	33.92.006.08.13	33.92.006.08.12
	1063	7	200 mA	33.92.006.08.15	33.92.006.08.14
	1299	8,7	250 mA	33.92.006.08.17	33.92.006.08.16
35°	782	5	150 mA	33.92.006.08.19	33.92.006.08.18
	1022	7	200 mA	33.92.006.08.21	33.92.006.08.20
	1248	8,7	250 mA	33.92.006.08.23	33.92.006.08.22
55°	796	5	150 mA	33.92.006.08.25	33.92.006.08.24
	1040	7	200 mA	33.92.006.08.27	33.92.006.08.26
	1270	8,7	250 mA	33.92.006.08.29	33.92.006.08.28

**COMPONENTS**

**DRIVER - EXTERNAL**

ON/OFF	Current	DIMENSION	COD
Power Supply 1-5W IP20	150 mA	22x32x76 mm	35.92.000.08.50
Power Supply 1-7W IP20	200 mA	23x39x76 mm	35.92.000.08.51
Power Supply 1-9W IP20	250 mA	23x39x76 mm	35.92.000.08.52
DALI	Current	DIMENSION	COD
Power Supply 3-5W IP20	150 mA	30x43x160 mm	35.92.000.08.97
Power Supply 4-7W IP20	200 mA	30x43x160 mm	35.92.000.08.98
Power Supply 5-9W IP20	250 mA	30x43x160 mm	35.92.000.08.99

> External Driver to be housed nearby.



CLASS II

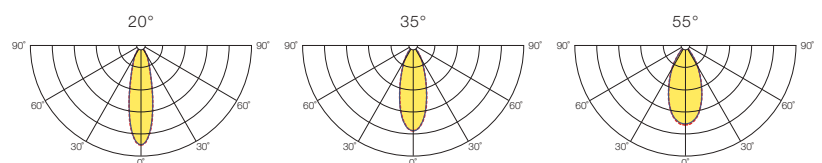
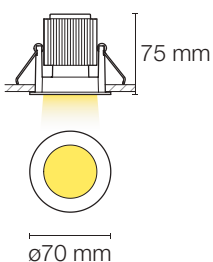

**QUICK INFO**

**GENERAL**

Recessed  
 IP44 (Optic)  
 IP20  
 IK06  
 960°C  
 Class III  
 Ta= -20°C +35°C

**OPTIC**

Clear Tempered Glass

**LED**

Efficacy up to 170 lm/W  
 3000 K, 4000 K  
 CRI >80  
 Lifetime 72 000 H  
 L80/B10 @Tc=65°C  
 150 mA, 200 mA, 250 mA

**ELECTRICAL SYSTEM**

230V/50Hz  
 ON/OFF, DALI

**FINISHING**

RAL 9003 Matt White  
 RAL 9005 Matt Black

**OPTIONS**

**LED**

2700 K  
 CRI >90

**ELECTRICAL SYSTEM**

DSI, DIM 1-10V, Phase-cut

**CONTROL SYSTEM**

Bluetooth

**FINISHING**

Other Colours

**EMERGENCY**

1 Hour, 3 Hours  
 DALI 1 Hour, 3 Hours

**SENSORS**

Motion  
 Ambient Light  
 Motion & Ambient Light

**TALLES 70 RO RECESSED  
 CLEAR GLASS DIFFUSER**

**IP44**

Beam Angle (°)	Output (lm)	LED Power (W)	LED Current	MATT WHITE	MATT BLACK
<b>3000 K</b>					
20°	608	5	150 mA	33.92.006.08.31	33.92.006.08.30
	779	7	200 mA	33.92.006.08.33	33.92.006.08.32
	941	8,7	250 mA	33.92.006.08.35	33.92.006.08.34
35°	584	5	150 mA	33.92.006.08.37	33.92.006.08.36
	748	7	200 mA	33.92.006.08.39	33.92.006.08.38
	904	8,7	250 mA	33.92.006.08.41	33.92.006.08.40
55°	595	5	150 mA	33.92.006.08.43	33.92.006.08.42
	762	7	200 mA	33.92.006.08.45	33.92.006.08.44
	920	8,7	250 mA	33.92.006.08.47	33.92.006.08.46
<b>4000 K</b>					
20°	757	5	150 mA	33.92.006.08.49	33.92.006.08.48
	989	7	200 mA	33.92.006.08.51	33.92.006.08.50
	1208	8,7	250 mA	33.92.006.08.53	33.92.006.08.52
35°	727	5	150 mA	33.92.006.08.55	33.92.006.08.54
	950	7	200 mA	33.92.006.08.57	33.92.006.08.56
	1161	8,7	250 mA	33.92.006.08.59	33.92.006.08.58
55°	741	5	150 mA	33.92.006.08.61	33.92.006.08.60
	967	7	200 mA	33.92.006.08.63	33.92.006.08.62
	1181	8,7	250 mA	33.92.006.08.65	33.92.006.08.64

**COMPONENTS**

**DRIVER - EXTERNAL**

ON/OFF	Current	DIMENSION	COD
Power Supply 1-5W IP20	150 mA	22x32x76 mm	35.92.000.08.50
Power Supply 1-7W IP20	200 mA	23x39x76 mm	35.92.000.08.51
Power Supply 1-9W IP20	250 mA	23x39x76 mm	35.92.000.08.52

DALI	Current	DIMENSION	COD
Power Supply 3-5W IP20	150 mA	30x43x160 mm	35.92.000.08.97
Power Supply 4-7W IP20	200 mA	30x43x160 mm	35.92.000.08.98
Power Supply 5-9W IP20	250 mA	30x43x160 mm	35.92.000.08.99

> External Driver to be housed nearby.



CLASS II

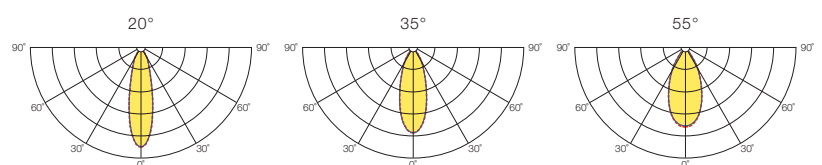
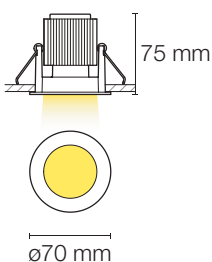



> TALLESS 70 RO RECESSED

# TALLES 80 RO IN IP20, IP44, IP65

## RECESSED



### PT

- > Downlight compacto para aplicação encastrada.
- > Versões IP20 ou com proteção IP44 ou IP65 com difusor em vidro temperado.
- > Fonte de luz recuada para controlo do encandeamento e elevado conforto visual.
- > Versões COB (Chip On Board) com três opções de ângulo de abertura: 20°, 35° ou 55°.
- > Driver externo de corrente constante e classe proteção II.
- > Também disponíveis versões para lâmpadas com suporte GU10 ou GU5.3.
- > Corpo em alumínio com molas para instalação sem ferramentas.

### ES

- > Downlight compacto para aplicación empotrada.
- > Versiones IP20 o con protección IP44 o IP65 con difusor en vidrio templado.
- > Posición reculada del LED para control del deslumbramiento y elevado confort visual.
- > Versiones COB (Chip On Board) con tres opciones de ángulo de apertura: 20°, 35° o 55°.
- > Driver externo de corriente constante y clase de protección II.
- > También están disponibles versiones para lámparas con soporte GU10 o GU5.3.
- > Cuerpo en aluminio con muelles de montaje rápido sin herramientas.

**QUICK INFO**

**GENERAL**

Recessed  
 IP20  
 960°C  
 Class III  
 Ta= -20°C +35°C

**OPTIC**

Clear PMMA

**LED**

Efficacy up to 170 lm/W  
 3000 K, 4000 K  
 CRI >80  
 Lifetime 72 000 H  
 L80/B10 @Tc=65°C  
 150 mA, 200 mA, 250 mA

**ELECTRICAL SYSTEM**

230V/50Hz  
 ON/OFF, DALI

**FINISHING**

RAL 9003 Matt White  
 RAL 9005 Matt Black

**OPTIONS**

**LED**

2700 K  
 CRI >90

**ELECTRICAL SYSTEM**

DSI, DIM 1-10V, Phase-cut

**CONTROL SYSTEM**

Bluetooth

**FINISHING**

Other Colours

**EMERGENCY**

1 Hour, 3 Hours  
 DALI 1 Hour, 3 Hours

**SENSORS**

Motion  
 Ambient Light  
 Motion & Ambient Light

**TALLES 80 RO IN RECESSED**

**IP20**

Beam Angle (°)	Output (lm)	LED Power (W)	LED Current	MATT WHITE	MATT BLACK
<b>3000 K</b>					
20°	508	5	150 mA	33.92.000.08.62	33.92.000.08.61
	620	7	200 mA	33.92.000.08.64	33.92.000.08.63
	787	8,7	250 mA	33.92.000.08.66	33.92.000.08.65
35°	552	5	150 mA	33.92.000.08.68	33.92.000.08.67
	674	7	200 mA	33.92.000.08.70	33.92.000.08.69
	854	8,7	250 mA	33.92.000.08.72	33.92.000.08.71
55°	563	5	150 mA	33.92.000.08.74	33.92.000.08.73
	790	7	200 mA	33.92.000.08.76	33.92.000.08.75
	982	8,7	250 mA	33.92.000.08.78	33.92.000.08.77
<b>4000 K</b>					
20°	508	5	150 mA	33.92.000.08.80	33.92.000.08.79
	620	7	200 mA	33.92.000.08.82	33.92.000.08.81
	787	8,7	250 mA	33.92.000.08.84	33.92.000.08.83
35°	552	5	150 mA	33.92.000.08.86	33.92.000.08.85
	674	7	200 mA	33.92.000.08.88	33.92.000.08.87
	854	8,7	250 mA	33.92.000.08.90	33.92.000.08.89
55°	563	5	150 mA	33.92.000.08.92	33.92.000.08.91
	790	7	200 mA	33.92.000.08.94	33.92.000.08.93
	982	8,7	250 mA	33.92.000.08.96	33.92.000.08.95

**COMPONENTS**

**DRIVER - EXTERNAL**



CLASS II

**ON/OFF**

Current	DIMENSION	COD	
Power Supply 1-5W IP20	150 mA	22x32x76 mm	35.92.000.08.50
Power Supply 1-7W IP20	200 mA	23x39x76 mm	35.92.000.08.51
Power Supply 1-9W IP20	250 mA	23x39x76 mm	35.92.000.08.52

**DALI**

Current	DIMENSION	COD	
Power Supply 3-5W IP20	150 mA	30x43x160 mm	35.92.000.08.97
Power Supply 4-7W IP20	200 mA	30x43x160 mm	35.92.000.08.98
Power Supply 5-9W IP20	250 mA	30x43x160 mm	35.92.000.08.99

> External Driver to be housed nearby.

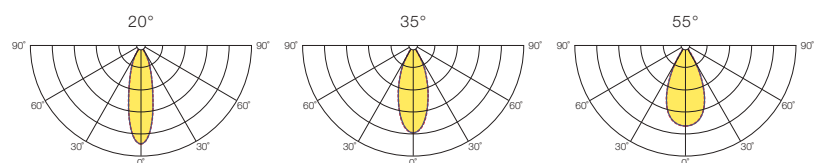
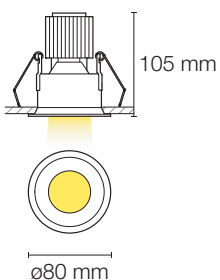

**QUICK INFO**

**GENERAL**

Recessed  
 IP44 (Optic)  
 IP20  
 IK05  
 960°C  
 Class III  
 Ta= -20°C +35°C

**OPTIC**

Clear Tempered Glass

**LED**

Efficacy up to 170 lm/W  
 3000 K, 4000 K  
 CRI >80  
 Lifetime 72 000 H  
 L80/B10 @Tc=65°C  
 150 mA, 200 mA, 250 mA

**ELETRICAL SYSTEM**

230V/50Hz  
 ON/OFF, DALI

**FINISHING**

RAL 9003 Matt White  
 RAL 9005 Matt Black

**OPTIONS**

**LED**

2700 K  
 CRI >90

**ELECTRICAL SYSTEM**

DSI, DIM 1-10V, Phase-cut

**CONTROL SYSTEM**

Bluetooth

**FINISHING**

Other Colours

**EMERGENCY**

1 Hour, 3 Hours  
 DALI 1 Hour, 3 Hours

**SENSORS**

Motion  
 Ambient Light  
 Motion & Ambient Light

**TALLES 80 RO IN RECESSED  
 CLEAR GLASS DIFFUSER**

**IP44**

Beam Angle (°)	Output (lm)	LED Power (W)	LED Current	MATT WHITE	MATT BLACK
<b>3000 K</b>					
20°	472	5	150 mA	33.92.001.08.34	33.92.001.08.33
	576	7	200 mA	33.92.001.08.36	33.92.001.08.35
	732	8,7	250 mA	33.92.001.08.38	33.92.001.08.37
35°	514	5	150 mA	33.92.001.08.40	33.92.001.08.39
	626	7	200 mA	33.92.001.08.42	33.92.001.08.41
	794	8,7	250 mA	33.92.001.08.44	33.92.001.08.43
55°	536	5	150 mA	33.92.001.08.46	33.92.001.08.45
	752	7	200 mA	33.92.001.08.48	33.92.001.08.47
	935	8,7	250 mA	33.92.001.08.50	33.92.001.08.49
<b>4000 K</b>					
20°	472	5	150 mA	33.92.001.08.52	33.92.001.08.51
	576	7	200 mA	33.92.001.08.54	33.92.001.08.53
	732	8,7	250 mA	33.92.001.08.56	33.92.001.08.55
35°	514	5	150 mA	33.92.001.08.58	33.92.001.08.57
	626	7	200 mA	33.92.001.08.60	33.92.001.08.59
	794	8,7	250 mA	33.92.001.08.62	33.92.001.08.61
55°	536	5	150 mA	33.92.001.08.64	33.92.001.08.63
	752	7	200 mA	33.92.001.08.66	33.92.001.08.65
	935	8,7	250 mA	33.92.001.08.68	33.92.001.08.67

**COMPONENTS**

**DRIVER - EXTERNAL**



CLASS II

ON/OFF	Current	DIMENSION	COD
Power Supply 1-5W IP20	150 mA	22x32x76 mm	35.92.000.08.50
Power Supply 1-7W IP20	200 mA	23x39x76 mm	35.92.000.08.51
Power Supply 1-9W IP20	250 mA	23x39x76 mm	35.92.000.08.52
DALI	Current	DIMENSION	COD
Power Supply 3-5W IP20	150 mA	30x43x160 mm	35.92.000.08.97
Power Supply 4-7W IP20	200 mA	30x43x160 mm	35.92.000.08.98
Power Supply 5-9W IP20	250 mA	30x43x160 mm	35.92.000.08.99

> External Driver to be housed nearby.

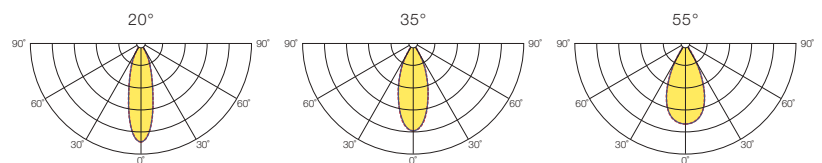
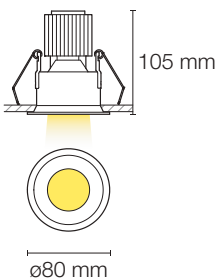



**QUICK INFO**

**GENERAL**

Recessed  
 IP65 (Optic)  
 IP20  
 IK05  
 960°C  
 Class III  
 Ta= -20°C +35°C

**OPTIC**

Clear Tempered Glass

**LED**

Efficacy up to 170 lm/W  
 3000 K, 4000 K  
 CRI >80  
 Lifetime 72 000 H  
 L80/B10 @Tc=65°C  
 150 mA, 200 mA, 250 mA

**ELECTRICAL SYSTEM**

230V/50Hz  
 ON/OFF, DALI

**FINISHING**

RAL 9003 Matt White  
 RAL 9005 Matt Black

**OPTIONS**

**LED**

2700 K  
 CRI >90

**ELECTRICAL SYSTEM**

DSI, DIM 1-10V, Phase-cut

**CONTROL SYSTEM**

Bluetooth

**FINISHING**

Other Colours

**EMERGENCY**

1 Hour, 3 Hours  
 DALI 1 Hour, 3 Hours

**SENSORS**

Motion  
 Ambient Light  
 Motion & Ambient Light

**TALLES 80 RO IN RECESSED  
 CLEAR GLASS DIFFUSER**

**IP65**

Beam Angle (°)	Output (lm)	LED Power (W)	LED Current	MATT WHITE	MATT BLACK
<b>3000 K</b>					
20°	472	5	150 mA	33.92.002.08.06	33.92.002.08.05
	576	7	200 mA	33.92.002.08.08	33.92.002.08.07
	732	8,7	250 mA	33.92.002.08.10	33.92.002.08.09
35°	514	5	150 mA	33.92.002.08.12	33.92.002.08.11
	626	7	200 mA	33.92.002.08.14	33.92.002.08.13
	794	8,7	250 mA	33.92.002.08.16	33.92.002.08.15
55°	536	5	150 mA	33.92.002.08.18	33.92.002.08.17
	752	7	200 mA	33.92.002.08.20	33.92.002.08.19
	935	8,7	250 mA	33.92.002.08.22	33.92.002.08.21
<b>4000 K</b>					
20°	472	5	150 mA	33.92.002.08.24	33.92.002.08.23
	576	7	200 mA	33.92.002.08.26	33.92.002.08.25
	732	8,7	250 mA	33.92.002.08.28	33.92.002.08.27
35°	514	5	150 mA	33.92.002.08.30	33.92.002.08.29
	626	7	200 mA	33.92.002.08.32	33.92.002.08.31
	794	8,7	250 mA	33.92.002.08.34	33.92.002.08.33
55°	536	5	150 mA	33.92.002.08.36	33.92.002.08.35
	752	7	200 mA	33.92.002.08.38	33.92.002.08.37
	935	8,7	250 mA	33.92.002.08.40	33.92.002.08.39

**COMPONENTS**

**DRIVER - EXTERNAL**

ON/OFF	Current	DIMENSION	COD
Power Supply 1-5W IP20	150 mA	22x32x76 mm	35.92.000.08.50
Power Supply 1-7W IP20	200 mA	23x39x76 mm	35.92.000.08.51
Power Supply 1-9W IP20	250 mA	23x39x76 mm	35.92.000.08.52
DALI	Current	DIMENSION	COD
Power Supply 3-5W IP20	150 mA	30x43x160 mm	35.92.000.08.97
Power Supply 4-7W IP20	200 mA	30x43x160 mm	35.92.000.08.98
Power Supply 5-9W IP20	250 mA	30x43x160 mm	35.92.000.08.99

> External Driver to be housed nearby.



CLASS II

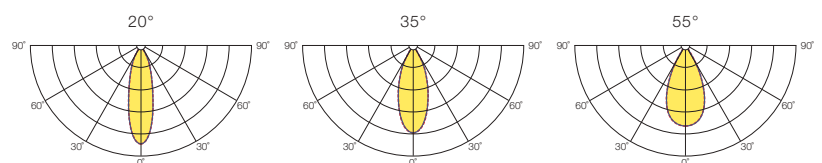
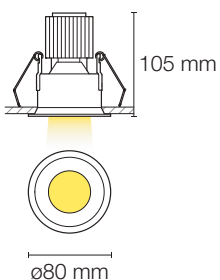

**QUICK INFO**

**GENERAL**

Recessed  
 IP44, IP65 (Optic)  
 IP20  
 IK05  
 960°C  
 Class II - GU10  
 Class III - GU5.3  
 Ta= -20°C +35°C

**OPTIC**

Clear Tempered Glass - IP44, IP65

**LAMP - NOT INCLUDED**

GU5.3 - 12 VAC  
 GU10 - 230V/50Hz

**ELETRICAL SYSTEM**

230V/50Hz  
 ON/OFF

**FINISHING**

RAL 9003 Matt White  
 RAL 9005 Matt Black

**OPTIONS**

**CONTROL SYSTEM**

Bluetooth

**FINISHING**

Other Colours

**SENSORS**

Motion

**TALLES 80 RO IN RECESSED - LAMP**

Type	LAMP Power (W)	MATT WHITE	MATT BLACK
<b>IP20</b>			
GU5.3	max. 50	33.92.000.01.38	33.92.000.01.37
GU10	max. 50	33.92.000.01.40	33.92.000.01.39
<b>IP44</b>			
GU5.3	max. 50	33.92.000.01.46	33.92.000.01.45
GU10	max. 50	33.92.000.01.48	33.92.000.01.47
<b>IP65</b>			
GU5.3	max. 50	33.92.000.01.54	33.92.000.01.53
GU10	max. 50	33.92.000.01.56	33.92.000.01.55

> Lamp not included.

**COMPONENTS**

**TRANSFORMER - EXTERNAL**



CLASS II

GU5.3	Voltage	DIMENSION	COD
Eletronic Transf. 16-60W IP20	12 VAC	30x43x160 mm	35.92.000.08.79
Eletronic Transf. 20-105W IP20	12 VAC	30x43x160 mm	35.92.000.08.78

> External Transformer to be housed nearby.

**RECOMENDED LAMPS**



**OSRAM**  
 PARATHOM  
 MR 16  
 GU5.3  
 4,6 W



**PHILIPS**  
 MASTER  
 LEDspot  
 GU5.3  
 5,5 W



**OSRAM**  
 PARATHOM  
 PAR 16  
 GU10  
 6,9 W



**PHILIPS**  
 Corepro  
 LEDspot  
 GU10  
 7 W

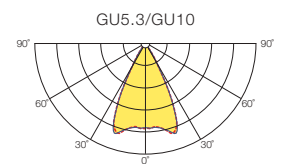
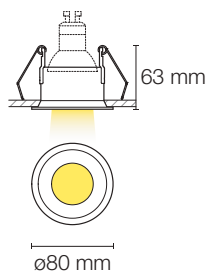

Lamp: 50W (GU5.3).



> TALLEs 80 RO RECESSED

# TALLES 80 SQ IN IP20, IP44, IP65

## RECESSED



### PT

- > Downlight compacto para aplicação encastrada.
- > Versões IP20 ou com proteção IP44 ou IP65 com difusor em vidro temperado.
- > Fonte de luz recuada para controlo do encandeamento e elevado conforto visual.
- > Versões COB (Chip On Board) com três opções de ângulo de abertura: 20°, 35° ou 55°.
- > Driver externo de corrente constante e classe proteção II.
- > Também disponíveis versões para lâmpadas com suporte GU10 ou GU5.3.
- > Corpo em alumínio com molas para instalação sem ferramentas.

### ES

- > Downlight compacto para aplicación empotrada.
- > Versiones IP20 o con protección IP44 o IP65 con difusor en vidrio templado.
- > Posición reculada del LED para control del deslumbramiento y elevado confort visual.
- > Versiones COB (Chip On Board) con tres opciones de ángulo de apertura: 20°, 35° o 55°.
- > Driver externo de corriente constante y clase de protección II.
- > También están disponibles versiones para lámparas con soporte GU10 o GU5.3.
- > Cuerpo en aluminio con muelles de montaje rápido sin herramientas.

**QUICK INFO**

**GENERAL**

Recessed  
 IP20  
 960°C  
 Class III  
 Ta= -20°C +35°C

**OPTIC**

Clear PMMA

**LED**

Efficacy up to 170 lm/W  
 3000 K, 4000 K  
 CRI >80  
 Lifetime 72 000 H  
 L80/B10 @Tc=65°C  
 150 mA, 200 mA, 250 mA

**ELECTRICAL SYSTEM**

230V/50Hz  
 ON/OFF, DALI

**FINISHING**

RAL 9003 Matt White  
 RAL 9005 Matt Black

**OPTIONS**

**LED**

2700 K  
 CRI >90

**ELECTRICAL SYSTEM**

DSI, DIM 1-10V, Phase-cut

**CONTROL SYSTEM**

Bluetooth

**FINISHING**

Other Colours

**EMERGENCY**

1 Hour, 3 Hours  
 DALI 1 Hour, 3 Hours

**SENSORS**

Motion  
 Ambient Light  
 Motion & Ambient Light

**TALLES 80 SQ IN RECESSED**

**IP20**

Beam Angle (°)	Output (lm)	LED Power (W)	LED Current	MATT WHITE	MATT BLACK
<b>3000 K</b>					
	508	5	150 mA	33.92.000.08.26	33.92.000.08.25
20°	620	7	200 mA	33.92.000.08.28	33.92.000.08.27
	787	8,7	250 mA	33.92.000.08.30	33.92.000.08.29
35°	552	5	150 mA	33.92.000.08.32	33.92.000.08.31
	674	7	200 mA	33.92.000.08.34	33.92.000.08.33
	854	8,7	250 mA	33.92.000.08.36	33.92.000.08.35
	567	5	150 mA	33.92.000.08.38	33.92.000.08.37
55°	794	7	200 mA	33.92.000.08.40	33.92.000.08.39
	987	8,7	250 mA	33.92.000.08.42	33.92.000.08.41
<b>4000 K</b>					
	508	5	150 mA	33.92.000.08.44	33.92.000.08.43
20°	620	7	200 mA	33.92.000.08.46	33.92.000.08.45
	787	8,7	250 mA	33.92.000.08.48	33.92.000.08.47
35°	552	5	150 mA	33.92.000.08.50	33.92.000.08.49
	674	7	200 mA	33.92.000.08.52	33.92.000.08.51
	854	8,7	250 mA	33.92.000.08.54	33.92.000.08.53
	567	5	150 mA	33.92.000.08.56	33.92.000.08.55
55°	794	7	200 mA	33.92.000.08.58	33.92.000.08.57
	987	8,7	250 mA	33.92.000.08.60	33.92.000.08.59

**COMPONENTS**

**DRIVER - EXTERNAL**



CLASS II

ON/OFF	Current	DIMENSION	COD
Power Supply 1-5W IP20	150 mA	22x32x76 mm	35.92.000.08.50
Power Supply 1-7W IP20	200 mA	23x39x76 mm	35.92.000.08.51
Power Supply 1-9W IP20	250 mA	23x39x76 mm	35.92.000.08.52
DALI	Current	DIMENSION	COD
Power Supply 3-5W IP20	150 mA	30x43x160 mm	35.92.000.08.97
Power Supply 4-7W IP20	200 mA	30x43x160 mm	35.92.000.08.98
Power Supply 5-9W IP20	250 mA	30x43x160 mm	35.92.000.08.99

> External Driver to be housed nearby.

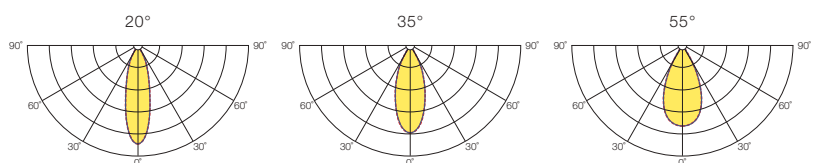
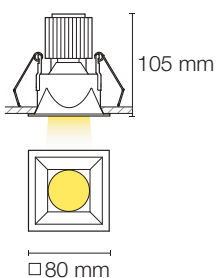

**QUICK INFO**

**GENERAL**

Recessed  
 IP44 (Optic)  
 IP20  
 IK05  
 960°C  
 Class III  
 Ta= -20°C +35°C

**OPTIC**

Clear Tempered Glass

**LED**

Efficacy up to 170 lm/W  
 3000 K, 4000 K  
 CRI >80  
 Lifetime 72 000 H  
 L80/B10 @Tc=65°C  
 150 mA, 200 mA, 250 mA

**ELETRICAL SYSTEM**

230V/50Hz  
 ON/OFF, DALI

**FINISHING**

RAL 9003 Matt White  
 RAL 9005 Matt Black

**OPTIONS**

**LED**

2700 K  
 CRI >90

**ELECTRICAL SYSTEM**

DSI, DIM 1-10V, Phase-cut

**CONTROL SYSTEM**

Bluetooth

**FINISHING**

Other Colours

**EMERGENCY**

1 Hour, 3 Hours  
 DALI 1 Hour, 3 Hours

**SENSORS**

Motion  
 Ambient Light  
 Motion & Ambient Light

**TALLES 80 SQ IN RECESSED  
 CLEAR GLASS DIFFUSER**

**IP44**

Beam Angle (°)	Output (lm)	LED Power (W)	LED Current	MATT WHITE	MATT BLACK
<b>3000 K</b>					
20°	472	5	150 mA	33.92.000.08.98	33.92.000.08.97
	576	7	200 mA	33.92.001.08.00	33.92.000.08.99
	732	8,7	250 mA	33.92.001.08.02	33.92.001.08.01
35°	514	5	150 mA	33.92.001.08.04	33.92.001.08.03
	626	7	200 mA	33.92.001.08.06	33.92.001.08.05
	794	8,7	250 mA	33.92.001.08.08	33.92.001.08.07
55°	540	5	150 mA	33.92.001.08.10	33.92.001.08.09
	757	7	200 mA	33.92.001.08.12	33.92.001.08.11
	940	8,7	250 mA	33.92.001.08.14	33.92.001.08.13
<b>4000 K</b>					
20°	472	5	150 mA	33.92.001.08.16	33.92.001.08.15
	576	7	200 mA	33.92.001.08.18	33.92.001.08.17
	732	8,7	250 mA	33.92.001.08.20	33.92.001.08.19
35°	514	5	150 mA	33.92.001.08.22	33.92.001.08.21
	626	7	200 mA	33.92.001.08.24	33.92.001.08.23
	794	8,7	250 mA	33.92.001.08.26	33.92.001.08.25
55°	540	5	150 mA	33.92.001.08.28	33.92.001.08.27
	757	7	200 mA	33.92.001.08.30	33.92.001.08.29
	940	8,7	250 mA	33.92.001.08.32	33.92.001.08.31

**COMPONENTS**

**DRIVER - EXTERNAL**

ON/OFF	Current	DIMENSION	COD
Power Supply 1-5W IP20	150 mA	22x32x76 mm	35.92.000.08.50
Power Supply 1-7W IP20	200 mA	23x39x76 mm	35.92.000.08.51
Power Supply 1-9W IP20	250 mA	23x39x76 mm	35.92.000.08.52

DALI	Current	DIMENSION	COD
Power Supply 3-5W IP20	150 mA	30x43x160 mm	35.92.000.08.97
Power Supply 4-7W IP20	200 mA	30x43x160 mm	35.92.000.08.98
Power Supply 5-9W IP20	250 mA	30x43x160 mm	35.92.000.08.99

> External Driver to be housed nearby.



CLASS II

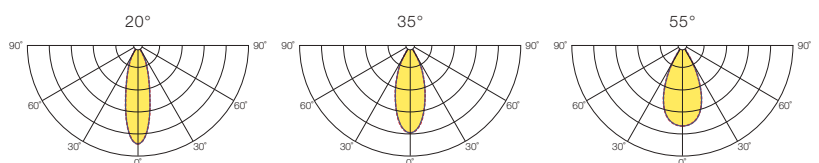
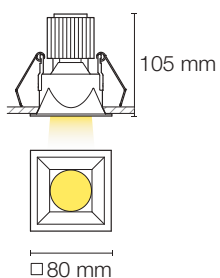

**QUICK INFO**

**GENERAL**

Recessed  
 IP65 (Optic)  
 IP20  
 IK05  
 960°C  
 Class III  
 Ta= -20°C +35°C

**OPTIC**

Clear Tempered Glass

**LED**

Efficacy up to 170 lm/W  
 3000 K, 4000 K  
 CRI >80  
 Lifetime 72 000 H  
 L80/B10 @Tc=65°C  
 150 mA, 200 mA, 250 mA

**ELECTRICAL SYSTEM**

230V/50Hz  
 ON/OFF, DALI

**FINISHING**

RAL 9003 Matt White  
 RAL 9005 Matt Black

**OPTIONS**

**LED**

2700 K  
 CRI >90

**ELECTRICAL SYSTEM**

DSI, DIM 1-10V, Phase-cut

**CONTROL SYSTEM**

Bluetooth

**FINISHING**

Other Colours

**EMERGENCY**

1 Hour, 3 Hours  
 DALI 1 Hour, 3 Hours

**SENSORS**

Motion  
 Ambient Light  
 Motion & Ambient Light

**TALLES 80 SQ IN RECESSED  
 CLEAR GLASS DIFFUSER**

**IP65**

Beam Angle (°)	Output (lm)	LED Power (W)	LED Current	MATT WHITE	MATT BLACK
<b>3000 K</b>					
20°	472	5	150 mA	33.92.001.08.70	33.92.001.08.69
	576	7	200 mA	33.92.001.08.72	33.92.001.08.71
	732	8,7	250 mA	33.92.001.08.74	33.92.001.08.73
35°	514	5	150 mA	33.92.001.08.76	33.92.001.08.75
	626	7	200 mA	33.92.001.08.78	33.92.001.08.77
	794	8,7	250 mA	33.92.001.08.80	33.92.001.08.79
55°	540	5	150 mA	33.92.001.08.82	33.92.001.08.81
	757	7	200 mA	33.92.001.08.84	33.92.001.08.83
	940	8,7	250 mA	33.92.001.08.86	33.92.001.08.85
<b>4000 K</b>					
20°	472	5	150 mA	33.92.001.08.88	33.92.001.08.87
	576	7	200 mA	33.92.001.08.90	33.92.001.08.89
	732	8,7	250 mA	33.92.001.08.92	33.92.001.08.91
35°	514	5	150 mA	33.92.001.08.94	33.92.001.08.93
	626	7	200 mA	33.92.001.08.96	33.92.001.08.95
	794	8,7	250 mA	33.92.001.08.98	33.92.001.08.97
55°	540	5	150 mA	33.92.002.08.00	33.92.001.08.99
	757	7	200 mA	33.92.002.08.02	33.92.002.08.01
	940	8,7	250 mA	33.92.002.08.04	33.92.002.08.03

**COMPONENTS**

**DRIVER - EXTERNAL**



CLASS II

ON/OFF	Current	DIMENSION	COD
Power Supply 1-5W IP20	150 mA	22x32x76 mm	35.92.000.08.50
Power Supply 1-7W IP20	200 mA	23x39x76 mm	35.92.000.08.51
Power Supply 1-9W IP20	250 mA	23x39x76 mm	35.92.000.08.52
DALI	Current	DIMENSION	COD
Power Supply 3-5W IP20	150 mA	30x43x160 mm	35.92.000.08.97
Power Supply 4-7W IP20	200 mA	30x43x160 mm	35.92.000.08.98
Power Supply 5-9W IP20	250 mA	30x43x160 mm	35.92.000.08.99

> External Driver to be housed nearby.

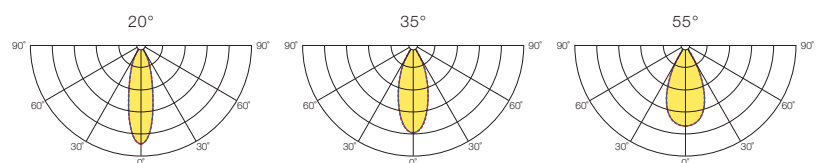
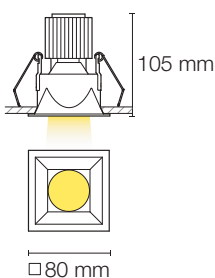

**QUICK INFO**

**GENERAL**

Recessed  
 IP44, IP65 (Optic)  
 IP20  
 IK05  
 960°C  
 Class II - GU10  
 Class III - GU5.3  
 Ta= -20°C +35°C

**OPTIC**

Clear Tempered Glass - IP44, IP65

**LAMP - NOT INCLUDED**

GU5.3 - 12 VAC  
 GU10 - 230V/50Hz

**ELETRICAL SYSTEM**

230V/50Hz  
 ON/OFF

**FINISHING**

RAL 9003 Matt White  
 RAL 9005 Matt Black

**OPTIONS**

**CONTROL SYSTEM**

Bluetooth

**FINISHING**

Other Colours

**SENSORS**

Motion

**TALLES 80 SQ IN RECESSED - LAMP**

Type	LAMP Power (W)	MATT WHITE	MATT BLACK
<b>IP20</b>			
GU5.3	max. 50	33.92.000.01.34	33.92.000.01.33
GU10	max. 50	33.92.000.01.36	33.92.000.01.35
<b>IP44</b>			
GU5.3	max. 50	33.92.000.01.42	33.92.000.01.41
GU10	max. 50	33.92.000.01.44	33.92.000.01.43
<b>IP65</b>			
GU5.3	max. 50	33.92.000.01.50	33.92.000.01.49
GU10	max. 50	33.92.000.01.52	33.92.000.01.51

> Lamp not included.

**COMPONENTS**

**TRANSFORMER - EXTERNAL**



CLASS II

GU5.3	Voltage	DIMENSION	COD
Eletronic Transf. 16-60W IP20	12 VAC	30x43x160 mm	35.92.000.08.79
Eletronic Transf. 20-105W IP20	12 VAC	30x43x160 mm	35.92.000.08.78

> External Transformer to be housed nearby.

**RECOMENDED LAMPS**



**OSRAM**  
 PARATHOM  
 MR 16  
 GU5.3  
 4,6 W



**PHILIPS**  
 MASTER  
 LEDspot  
 GU5.3  
 5,5 W



**OSRAM**  
 PARATHOM  
 PAR 16  
 GU10  
 6,9 W



**PHILIPS**  
 Corepro  
 LEDspot  
 GU10  
 7 W

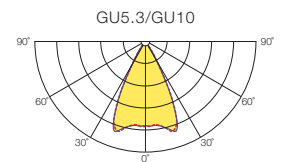
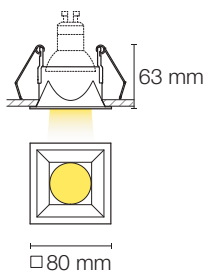

Lamp: 50W (GU5.3).





> **TALLES 80 SQ RECESSED**

# TALLES 90 RO IP65

## RECESSED

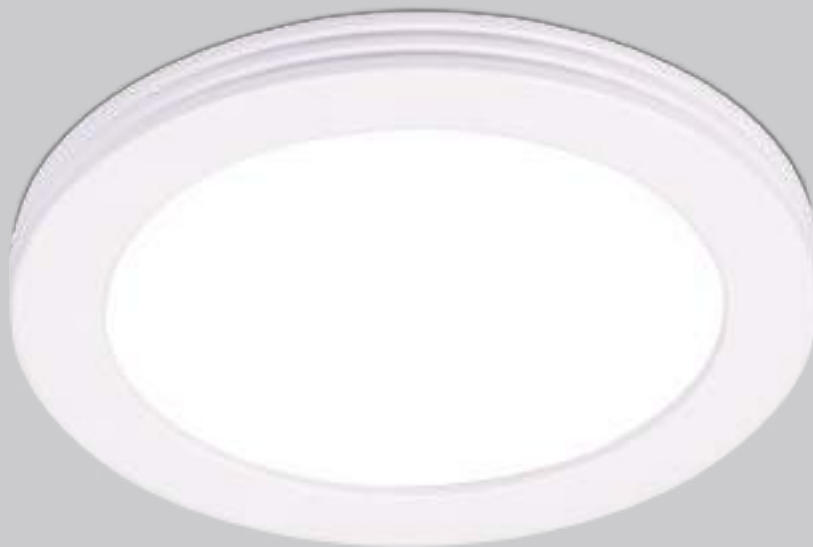

### PT

- > Downlight compacto para aplicação encastrada com elevado grau de proteção (IP65).
- > Com molas de fixação rápida para instalação sem ferramentas.
- > Driver externo de corrente constante e classe proteção II.
- > Difusor PMMA Opal para iluminação homogénea, difusa e eficiente.
- > Aro de remate em alumínio com revestimento a epoxy-poliéster.

### ES

- > Downlight compacto para aplicación empotrada con elevado grado de protección (IP65).
- > Con muelles de montaje rápido sin ayuda de herramientas.
- > Driver externo de corriente constante y clase de protección II.
- > Difusor PMMA Opal.
- > Aro frontal en aluminio con recubrimiento epoxy-poliéster.

**QUICK INFO**

**GENERAL**

Recessed  
 IP65 (Optic)  
 IP30  
 IK05  
 650°C  
 Class III  
 Ta= -20°C +35°C

**OPTIC**

Opal PMMA

**LED**

Efficacy up to 154 lm/W  
 3000 K, 4000 K  
 CRI >80  
 Lifetime 50 000 H  
 L80/B10 @Tc=65°C  
 200 mA, 300 mA

**ELECTRICAL SYSTEM**

230V/50Hz  
 ON/OFF, DALI

**FINISHING**

RAL 9003 Matt White  
 RAL 9005 Matt Black

**TALLES 90 RO RECESSED  
 OPAL DIFFUSER**

**IP65**

Output (lm)	LED		MATT WHITE	MATT BLACK
	Power (W)	Current		
<b>3000 K</b>				
537	5	200 mA	33.92.004.08.60	33.92.004.08.62
719	8	300 mA	33.92.004.08.61	33.92.004.08.63
<b>4000 K</b>				
563	5	200 mA	33.92.004.08.68	33.92.004.08.70
753	8	300 mA	33.92.004.08.69	33.92.004.08.71

**COMPONENTS**

**DRIVER - EXTERNAL**



CLASS II

**ON/OFF**

	Current	DIMENSION	COD
Power Supply 1-7W IP20	200 mA	23x39x76 mm	35.92.000.08.51
Power Supply 5-9W IP20	300 mA	30x43x97 mm	35.92.001.08.00

**DALI**

	Current	DIMENSION	COD
Power Supply 4-7W IP20	200 mA	30x43x160 mm	35.92.000.08.98
Power Supply 5-9W IP20	300 mA	30x43x160 mm	35.92.001.08.01

> External Driver to be housed nearby.

**OPTIONS**

**LED**

2700 K, 5000 K, 6500 K  
 RGB, RGBW  
 CRI >90

**ELECTRICAL SYSTEM**

DSI, DIM 1-10V, Phase-cut

**CONTROL SYSTEM**

Bluetooth

**FINISHING**

Other Colours

**EMERGENCY**

1 Hour, 3 Hours  
 DALI 1 Hour, 3 Hours

**SENSORS**

Motion  
 Ambient Light  
 Motion & Ambient Light

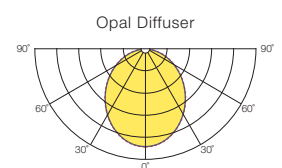
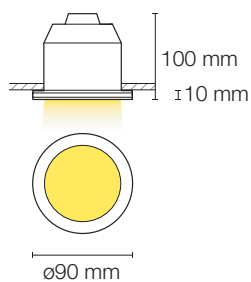



> **TALLES 90 RO** RECESSED



> **TALLES 90 SQ RECESSED**

# TALLES 90 SQ IP20, IP44

## RECESSED



### PT

- > Downlight de luz homogénea para aplicação encastrada.
- > Proteção IP44 na face visível.
- > Com molas de fixação rápida para instalação sem ferramentas.
- > Adequado para instalação em tetos falsos com espessura entre 5 e 20 mm.
- > Driver externo de corrente constante e classe proteção II.
- > Difusor Policarbonato Opal para iluminação homogénea, difusa e eficiente.
- > Moldura de remate em alumínio com revestimento a epoxy-poliéster.

### ES

- > Downlight de luz homogénea para aplicación empotrada.
- > Protección IP44 en el cuerpo visible.
- > Con muelles de montaje rápido sin ayuda de herramientas.
- > Adecuado para la instalación en falsos techos con espesor entre 5 y 20 mm.
- > Driver externo de corriente constante y clase de protección II.
- > Difusor Policarbonato Opal.
- > Marco frontal en aluminio con recubrimiento epoxi-poliéster.

**QUICK INFO**

**GENERAL**

Recessed  
 IP44 (Optic)  
 IP20  
 IK04  
 850°C  
 Class III  
 Ta= -20°C +35°C

**OPTIC**

Opal Polycarbonate

**LED**

Efficacy up to 177 lm/W  
 3000 K, 4000 K  
 CRI >80  
 Lifetime 50 000 H  
 L80/B10 @Tc=65°C  
 150 mA, 200 mA

**ELECTRICAL SYSTEM**

230V/50Hz  
 ON/OFF, DALI

**FINISHING**

RAL 9003 Matt White  
 RAL 9005 Matt Black

**TALLES 90 SQ RECESSED**

**OPAL DIFFUSER**

**IP44**

Output (lm)	LED Power (W)	LED Current	MATT WHITE	MATT BLACK
<b>3000 K</b>				
358	5	150 mA	33.92.003.08.54	33.92.003.08.56
501	7	200 mA	33.92.003.08.55	33.92.003.08.57
<b>4000 K</b>				
373	5	150 mA	33.92.003.08.62	33.92.003.08.64
522	7	200 mA	33.92.003.08.63	33.92.003.08.65

**COMPONENTS**

**DRIVER - EXTERNAL**



CLASS II

ON/OFF	Current	DIMENSION	COD
Power Supply 1-5W IP20	150 mA	22x32x76 mm	35.92.000.08.50
Power Supply 1-7W IP20	200 mA	23x39x76 mm	35.92.000.08.51
DALI	Current	DIMENSION	COD
Power Supply 3-5W IP20	150 mA	30x43x160 mm	35.92.000.08.97
Power Supply 4-7W IP20	200 mA	30x43x160 mm	35.92.000.08.98

> External Driver to be housed nearby.

**OPTIONS**

**LED**

2700 K, 5000 K, 6500 K  
 RGB, RGBW  
 CRI >90

**ELECTRICAL SYSTEM**

DSI, DIM 1-10V, Phase-cut

**CONTROL SYSTEM**

Bluetooth

**FINISHING**

Other Colours

**EMERGENCY**

1 Hour, 3 Hours  
 DALI 1 Hour, 3 Hours

**SENSORS**

Motion  
 Ambient Light  
 Motion & Ambient Light

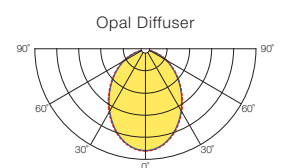
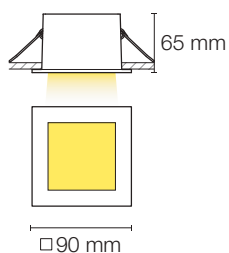

**QUICK INFO**

**GENERAL**

Recessed  
 IP44 (Optic)  
 IP20  
 IK05  
 960°C  
 Class II - GU10  
 Class III - GU5.3  
 Ta= -20°C +35°C

**OPTIC**

Clear Tempered Glass - IP44

**LAMP - NOT INCLUDED**

GU5.3 - 12 VAC  
 GU10 - 230V/50Hz

**ELETRICAL SYSTEM**

230V/50Hz  
 ON/OFF

**FINISHING**

RAL 9003 Matt White  
 RAL 9005 Matt Black

**TALLES 90 SQ RECESSED - LAMP**

Type	LAMP Power (W)	MATT WHITE	MATT BLACK
		IP20	
GU5.3	max. 50	33.92.000.01.63	33.92.000.01.64
GU10	max. 50	33.92.000.01.65	33.92.000.01.66
IP44			
GU5.3	max. 50	33.92.000.01.77	33.92.000.01.78
GU10	max. 50	33.92.000.01.79	33.92.000.01.80

> Lamp not included.

**COMPONENTS**

**TRANSFORMER - EXTERNAL**



CLASS II

GU5.3	Voltage	DIMENSION	COD
Eletronic Transf. 16-60W IP20	12 VAC	30x43x160 mm	35.92.000.08.79
Eletronic Transf. 20-105W IP20	12 VAC	30x43x160 mm	35.92.000.08.78

> External Transformer to be housed nearby.

**OPTIONS**

**CONTROL SYSTEM**

Bluetooth

**FINISHING**

Other Colours

**SENSORS**

Motion

**RECOMENDED LAMPS**



**OSRAM**  
 PARATHOM  
 MR 16  
 GU5.3  
 4,6 W



**PHILIPS**  
 MASTER  
 LEDspot  
 GU5.3  
 5,5 W



**OSRAM**  
 PARATHOM  
 PAR 16  
 GU10  
 6,9 W



**PHILIPS**  
 Corepro  
 LEDspot  
 GU10  
 7 W

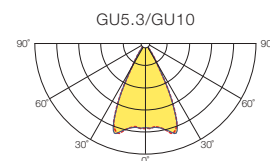
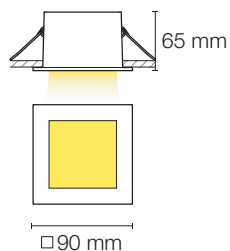

Lamp: 50W (GU5.3).





> TALLES 90 SQ RECESSED

# TALLES 130 RO IP44

## RECESSED



### PT

- > Downlight de luz homogénea para aplicação encastrada.
- > Fonte de luz recuada para controlo do encandeamento e elevado conforto visual.
- > Três opções de ângulo de abertura do feixe: 21°, 36° ou 58°.
- > IP44 com difusor de proteção em vidro temperado.
- > Com molas de fixação rápida para instalação sem ferramentas.
- > Luminária com Driver incorporado.
- > Refletor em alumínio Miro-Silver® de elevada eficiência.
- > Aro de remate em alumínio com revestimento a epoxy-poliéster.

### ES

- > Downlight de luz homogénea para aplicación empotrada.
- > Posición reculada del LED para control del deslumbramiento y elevado confort visual.
- > Tres opciones de ángulo de emisión: 21°, 36° o 58°.
- > IP44 con difusor de protección en vidrio templado.
- > Con muelles de montaje rápido sin ayuda de herramientas.
- > Luminaria con Driver incorporado.
- > Reflector en aluminio Miro-Silver® de alta eficiencia.
- > Aro frontal en aluminio con recubrimiento epoxi-poliéster.

**QUICK INFO**

**GENERAL**

Recessed  
 IP44 (Optic)  
 IP20  
 IK05  
 960°C  
 Class II  
 Ta= -20°C +35°C

**OPTIC**

Aluminium Reflector  
 Clear Tempered Glass

**LED**

Efficacy up to 170 lm/W  
 3000 K, 4000 K  
 CRI >80  
 Lifetime 50 000 H  
 L80/B10 @Tc=65°C

**ELETRICAL SYSTEM**

230V/50Hz  
 ON/OFF, DALI

**FINISHING**

RAL 9003 Matt White

**OPTIONS**

**LED**

2700 K, 5000 K, 5700 K  
 CRI >90

**ELECTRICAL SYSTEM**

DSI, DIM 1-10V, Phase-cut

**CONTROL SYSTEM**

Bluetooth

**FINISHING**

Other Colours

**EMERGENCY**

1 Hour, 3 Hours  
 DALI 1 Hour, 3 Hours

**SENSORS**

Motion  
 Ambient Light  
 Motion & Ambient Light

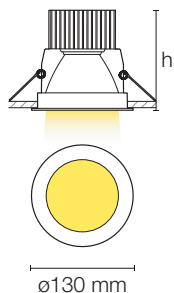

**TALLES 130 RO RECESSED  
 CLEAR GLASS DIFFUSER**

**IP44 - MATT WHITE FINISHING**

Beam Angle (°)	h (mm)	Output (lm)	System (W)	ON/OFF	DALI
<b>3000 K</b>					
21°	105	1254	10	33.92.002.08.56	33.92.003.08.04
	105	2092	17	33.92.002.08.59	33.92.003.08.07
	115	2816	24	33.92.002.08.62	33.92.003.08.10
36°	135	4065	31	33.92.002.08.65	33.92.003.08.13
	105	1210	10	33.92.002.08.57	33.92.003.08.05
	105	1994	17	33.92.002.08.60	33.92.003.08.08
58°	115	2718	24	33.92.002.08.63	33.92.003.08.11
	135	3926	31	33.92.002.08.66	33.92.003.08.14
	105	1272	10	33.92.002.08.58	33.92.003.08.06
58°	105	2103	17	33.92.002.08.61	33.92.003.08.09
	115	2827	24	33.92.002.08.64	33.92.003.08.12
	135	4110	31	33.92.002.08.67	33.92.003.08.15
<b>4000 K</b>					
21°	105	1254	10	33.92.002.08.68	33.92.003.08.28
	105	2092	17	33.92.002.08.71	33.92.003.08.31
	115	2816	24	33.92.002.08.74	33.92.003.08.34
36°	135	4065	31	33.92.002.08.77	33.92.003.08.37
	105	1210	10	33.92.002.08.69	33.92.003.08.29
	105	1994	17	33.92.002.08.72	33.92.003.08.32
58°	115	2718	24	33.92.002.08.75	33.92.003.08.35
	135	3926	31	33.92.002.08.78	33.92.003.08.38
	105	1272	10	33.92.002.08.70	33.92.003.08.30
58°	105	2103	17	33.92.002.08.73	33.92.003.08.33
	115	2827	24	33.92.002.08.76	33.92.003.08.36
	135	4110	31	33.92.002.08.79	33.92.003.08.39

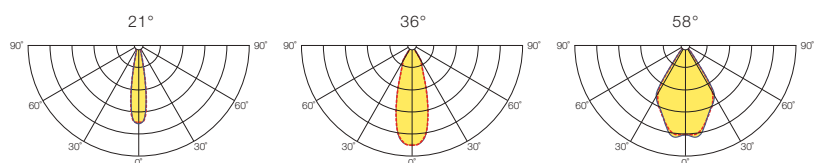

**QUICK INFO**

**GENERAL**

Recessed  
 IP44 (Optic)  
 IP20  
 IK05  
 960°C  
 Class II  
 Ta= -20°C +35°C

**OPTIC**

Aluminium Reflector  
 Clear Tempered Glass

**LED**

Efficacy up to 170 lm/W  
 3000 K, 4000 K  
 CRI >80  
 Lifetime 50 000 H  
 L80/B10 @TC=65°C

**ELECTRICAL SYSTEM**

230V/50Hz  
 ON/OFF, DALI

**FINISHING**

RAL 9005 Matt Black

**OPTIONS**

**LED**

2700 K, 5000 K, 5700 K  
 CRI >90

**ELECTRICAL SYSTEM**

DSI, DIM 1-10V, Phase-cut

**CONTROL SYSTEM**

Bluetooth

**FINISHING**

Other Colours

**EMERGENCY**

1 Hour, 3 Hours  
 DALI 1 Hour, 3 Hours

**SENSORS**

Motion  
 Ambient Light  
 Motion & Ambient Light

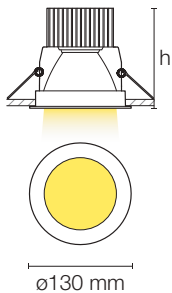

**TALLES 130 RO RECESSED  
 CLEAR GLASS DIFFUSER**

**IP44 - MATT BLACK FINISHING**

Beam Angle (°)	h (mm)	Output (lm)	System (W)	ON/OFF	DALI
<b>3000 K</b>					
21°	105	1254	10	33.92.002.08.80	33.92.003.08.16
	105	2092	17	33.92.002.08.83	33.92.003.08.19
	115	2816	24	33.92.002.08.86	33.92.003.08.22
36°	135	4065	31	33.92.002.08.89	33.92.003.08.25
	105	1210	10	33.92.002.08.81	33.92.003.08.17
	105	1994	17	33.92.002.08.84	33.92.003.08.20
58°	115	2718	24	33.92.002.08.87	33.92.003.08.23
	135	3926	31	33.92.002.08.90	33.92.003.08.26
	105	1272	10	33.92.002.08.82	33.92.003.08.18
58°	105	2103	17	33.92.002.08.85	33.92.003.08.21
	115	2827	24	33.92.002.08.88	33.92.003.08.24
	135	4110	31	33.92.002.08.91	33.92.003.08.27
<b>4000 K</b>					
21°	105	1254	10	33.92.002.08.92	33.92.003.08.40
	105	2092	17	33.92.002.08.95	33.92.003.08.43
	115	2816	24	33.92.002.08.98	33.92.003.08.46
36°	135	4065	31	33.92.003.08.01	33.92.003.08.49
	105	1210	10	33.92.002.08.93	33.92.003.08.41
	105	1994	17	33.92.002.08.96	33.92.003.08.44
58°	115	2718	24	33.92.002.08.99	33.92.003.08.47
	135	3926	31	33.92.003.08.02	33.92.003.08.50
	105	1272	10	33.92.002.08.94	33.92.003.08.42
58°	105	2103	17	33.92.002.08.97	33.92.003.08.45
	115	2827	24	33.92.003.08.00	33.92.003.08.48
	135	4110	31	33.92.003.08.03	33.92.003.08.51

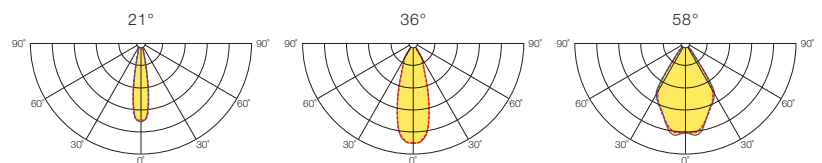



> **TALLES 130 RO** RECESSED

# TALLES 137 RO IP44

## RECESSED

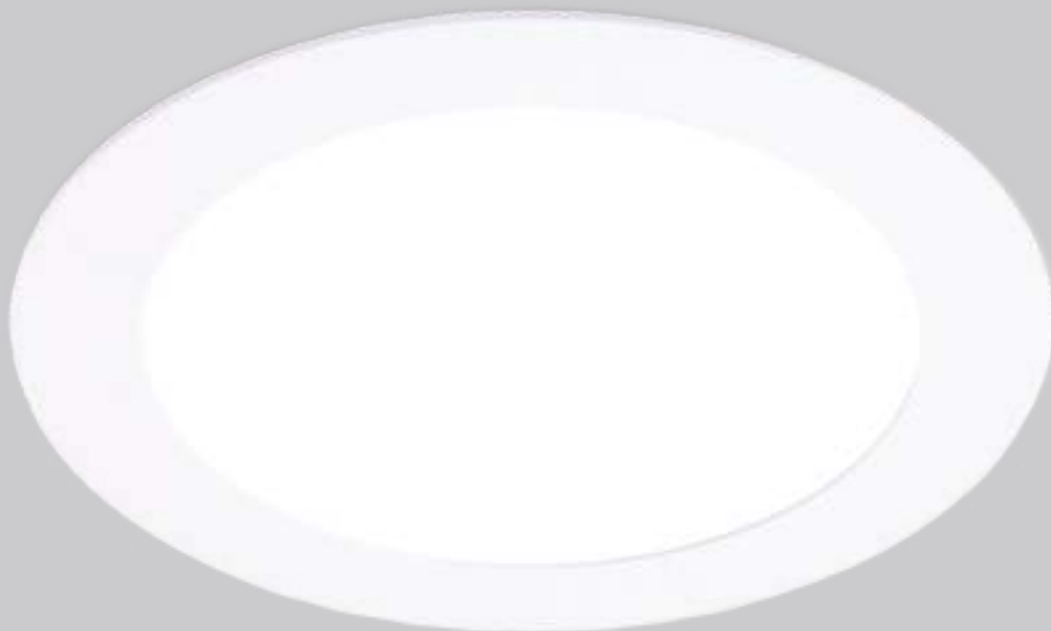

### PT

- > Downlight de luz homogénea para aplicação encastrada.
- > Proteção IP44 na face visível.
- > Com molas de fixação rápida para instalação sem ferramentas.
- > Adequado para instalação em tetos falsos com espessura entre 1 e 25 mm.
- > Driver externo de corrente constante e classe proteção II.
- > Difusor Policarbonato Opal para iluminação homogénea, difusa e eficiente.
- > Aro de remate em alumínio com revestimento a epoxy-poliéster.

### ES

- > Downlight de luz homogénea para aplicación empotrada.
- > Protección IP44 en el cuerpo visible.
- > Con muelles de montaje rápido sin ayuda de herramientas.
- > Adecuado para la instalación en falsos techos con espesor entre 1 y 25 mm.
- > Driver externo de corriente constante y clase de protección II.
- > Difusor Policarbonato Opal.
- > Aro frontal en aluminio con recubrimiento epoxi-poliéster.

**QUICK INFO**

**GENERAL**

Recessed  
 IP44 (Optic)  
 IP20  
 IK06  
 850°C  
 Class III  
 Ta= -20°C +35°C

**OPTIC**

Opal Polycarbonate

**LED**

Efficacy up to 163 lm/W  
 3000 K, 4000 K  
 CRI >80  
 Lifetime 50 000 H  
 L80/B10 @Tc=80°C  
 250 mA, 350 mA, 500 mA

**ELECTRICAL SYSTEM**

230V/50Hz  
 ON/OFF, DALI

**FINISHING**

RAL 9003 Matt White  
 RAL 9005 Matt Black

**TALLES 137 RO RECESSED  
 OPAL DIFFUSER**

**IP44**

Output (lm)	LED Power (W)	LED Current	MATT WHITE	MATT BLACK
<b>3000 K</b>				
568	6	250 mA	33.92.003.08.70	33.92.003.08.73
757	8	350 mA	33.92.003.08.71	33.92.003.08.74
1135	12	500 mA	33.92.003.08.72	33.92.003.08.75
<b>4000 K</b>				
593	6	250 mA	33.92.003.08.82	33.92.003.08.85
800	8	350 mA	33.92.003.08.83	33.92.003.08.86
1190	12	500 mA	33.92.003.08.84	33.92.003.08.87

**COMPONENTS**

**DRIVER - EXTERNAL**



CLASS II

ON/OFF	Current	DIMENSION	COD
Power Supply 4-9W IP20	250 mA	31x70x200 mm	35.92.003.01.07
Power Supply 6-15W IP20	350 mA	31x70x200 mm	35.92.003.01.08
Power Supply 12-22W IP20	500 mA	31x70x200 mm	35.92.003.01.09

DALI	Current	DIMENSION	COD
Power Supply 4-9W IP20	250 mA	31x70x200 mm	35.92.003.01.10
Power Supply 6-15W IP20	350 mA	31x70x200 mm	35.92.003.01.11
Power Supply 12-22W IP20	500 mA	31x70x200 mm	35.92.003.01.12

> External Driver to be housed nearby.

**OPTIONS**

**LED**

2700 K, 5000 K, 6500 K  
 Tunable White, RGB, RGBW  
 CRI >90

**ELECTRICAL SYSTEM**

DSI, DIM 1-10V, Phase-cut

**CONTROL SYSTEM**

Bluetooth

**FINISHING**

Other Colours

**EMERGENCY**

1 Hour, 3 Hours  
 DALI 1 Hour, 3 Hours

**SENSORS**

Motion  
 Ambient Light  
 Motion & Ambient Light

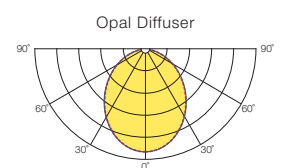
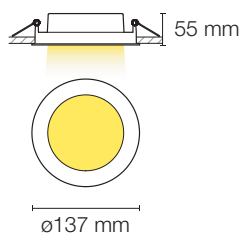



> TALLEES 137 RO RECESSED





> TALLEs 145 SQ RECESSED

# TALLES 145 SQ IP44

## RECESSED

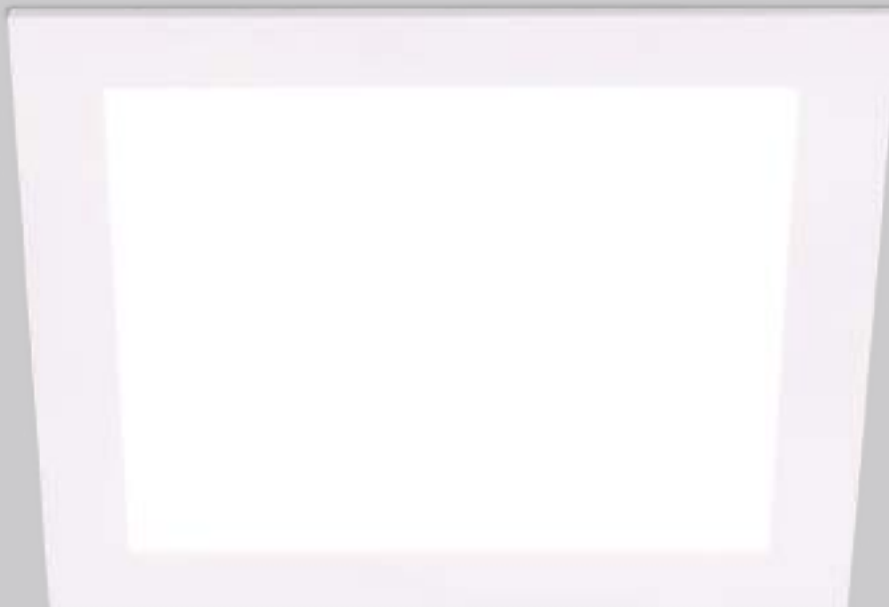

### PT

- > Downlight de luz homogénea para aplicação encastrada.
- > Proteção IP44 na face visível.
- > Com molas de fixação rápida para instalação sem ferramentas.
- > Adequado para instalação em tetos falsos com espessura entre 5 e 20 mm.
- > Driver externo de corrente constante e classe proteção II.
- > Difusor Policarbonato Opal para iluminação homogénea, difusa e eficiente.
- > Moldura de remate em alumínio com revestimento a epoxy-poliéster.

### ES

- > Downlight de luz homogénea para aplicación empotrada.
- > Protección IP44 en el cuerpo visible.
- > Con muelles de montaje rápido sin ayuda de herramientas.
- > Adecuado para la instalación en falsos techos con espesor entre 5 y 20 mm.
- > Driver externo de corriente constante y clase de protección II.
- > Difusor Policarbonato Opal.
- > Marco frontal en aluminio con recubrimiento epoxy-poliéster.

**QUICK INFO**

**GENERAL**

Recessed  
 IP44 (Optic)  
 IP20  
 IK06  
 850°C  
 Class III  
 Ta= -20°C +35°C

**OPTIC**

Opal Polycarbonate

**LED**

Efficacy up to 147 lm/W  
 3000 K, 4000 K  
 CRI >80  
 Lifetime 50 000 H  
 L80/B10 @Tc=55°C  
 400 mA, 600 mA

**ELECTRICAL SYSTEM**

230V/50Hz  
 ON/OFF, DALI

**FINISHING**

RAL 9003 Matt White  
 RAL 9005 Matt Black

**TALLES 145 SQ RECESSED  
 OPAL DIFFUSER**

**IP44**

Output (lm)	LED Power (W)	LED Current	MATT WHITE	MATT BLACK
<b>3000 K</b>				
679	13	400 mA	33.92.003.08.95	33.92.003.08.98
966	21	600 mA	33.92.003.08.96	33.92.003.08.99
<b>4000 K</b>				
724	13	400 mA	33.92.004.08.07	33.92.004.08.10
1030	21	600 mA	33.92.004.08.08	33.92.004.08.11

**COMPONENTS**

**DRIVER - EXTERNAL**



CLASS II

ON/OFF	Current	DIMENSION	COD
Power Supply 7-15W IP20	400 mA	31x70x200 mm	35.92.001.08.02
Power Supply 15-22W IP20	600 mA	31x70x200 mm	35.92.001.08.03
DALI	Current	DIMENSION	COD
Power Supply 7-15W IP20	400 mA	31x70x200 mm	35.92.001.08.04
Power Supply 15-22W IP20	600 mA	31x70x200 mm	35.92.001.08.05

> External Driver to be housed nearby.

**OPTIONS**

**LED**

2700 K, 5000 K, 6500 K  
 Tunable White, RGB, RGBW  
 CRI >90

**ELECTRICAL SYSTEM**

DSI, DIM 1-10V, Phase-cut

**CONTROL SYSTEM**

Bluetooth

**FINISHING**

Other Colours

**EMERGENCY**

1 Hour, 3 Hours  
 DALI 1 Hour, 3 Hours

**SENSORS**

Motion  
 Ambient Light  
 Motion & Ambient Light

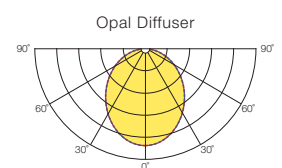
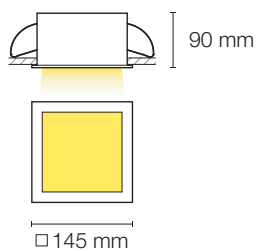

# TALLES 187 RO IP44

## RECESSED

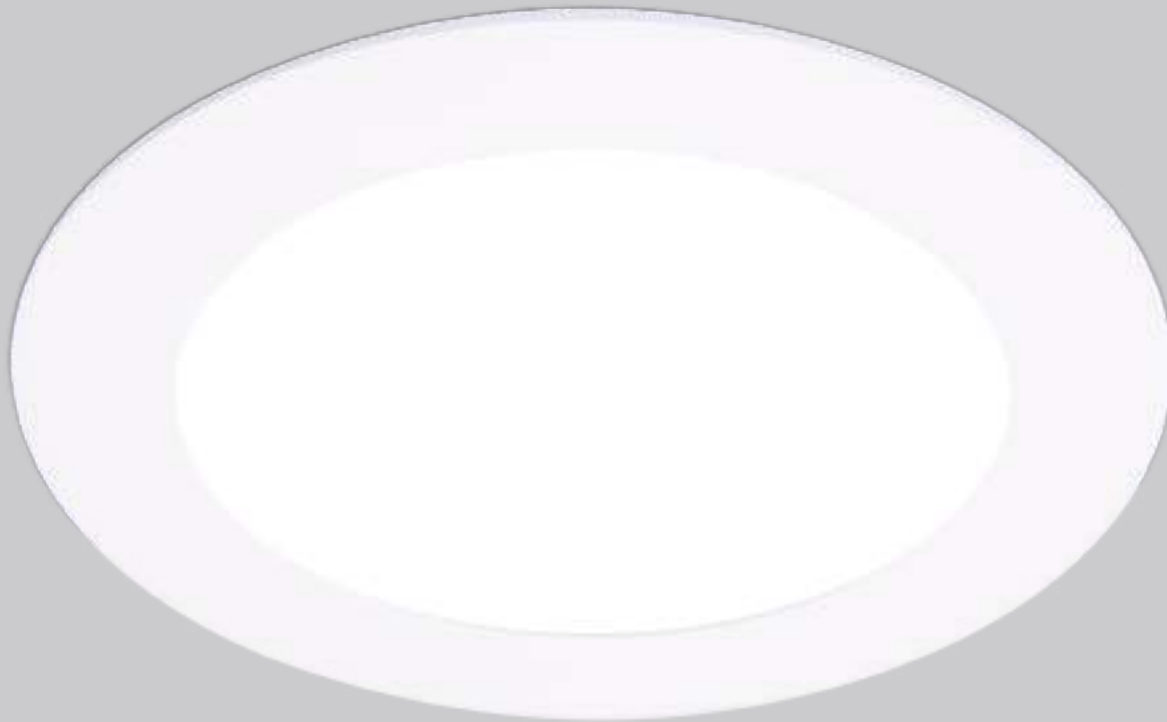

### PT

- > Downlight de luz homogénea para aplicação encastrada.
- > Proteção IP44 na face visível.
- > Com molas de fixação rápida para instalação sem ferramentas.
- > Adequado para instalação em tetos falsos com espessura entre 1 e 25 mm.
- > Driver externo de corrente constante e classe proteção II.
- > Difusor Policarbonato Opal para iluminação homogénea, difusa e eficiente.
- > Aro de remate em alumínio com revestimento a epoxy-poliéster.

### ES

- > Downlight de luz homogénea para aplicación empotrada.
- > Protección IP44 en el cuerpo visible.
- > Con muelles de montaje rápido sin ayuda de herramientas.
- > Adecuado para la instalación en falsos techos con espesor entre 1 y 25 mm.
- > Driver externo de corriente constante y clase de protección II.
- > Difusor Policarbonato Opal.
- > Aro frontal en aluminio con recubrimiento epoxi-poliéster.

**QUICK INFO**

**GENERAL**

Recessed  
 IP44 (Optic)  
 IP20  
 IK06  
 850°C  
 Class III  
 Ta= -20°C +35°C

**OPTIC**

Opal Polycarbonate

**LED**

Efficacy up to 166 lm/W  
 3000 K, 4000 K  
 CRI >80  
 Lifetime 50 000 H  
 L80/B10 @Tc=80°C  
 350 mA, 500 mA, 700 mA

**ELECTRICAL SYSTEM**

230V/50Hz  
 ON/OFF, DALI

**FINISHING**

RAL 9003 Matt White  
 RAL 9005 Matt Black

**TALLES 187 RO RECESSED  
 OPAL DIFFUSER**

**IP44**

Output (lm)	LED Power (W)	LED Current	MATT WHITE	MATT BLACK
<b>3000 K</b>				
825	8	350 mA	33.92.004.08.18	33.92.004.08.21
1238	12	500 mA	33.92.004.08.19	33.92.004.08.22
1753	17	700 mA	33.92.004.08.20	33.92.004.08.23
<b>4000 K</b>				
871	8	350 mA	33.92.004.08.30	33.92.004.08.33
1308	12	500 mA	33.92.004.08.31	33.92.004.08.34
1842	17	700 mA	33.92.004.08.32	33.92.004.08.35

**COMPONENTS**

**DRIVER - EXTERNAL**



CLASS II

ON/OFF	Current	DIMENSION	COD
Power Supply 6-15W IP20	350 mA	31x70x200 mm	35.92.00.000027
Power Supply 9-15W IP20	500 mA	31x70x200 mm	35.92.00.000028
Power Supply 17-22W IP20	700 mA	31x70x200 mm	35.92.00.000029

DALI	Current	DIMENSION	COD
Power Supply 6-15W IP20	350 mA	31x70x200 mm	35.92.00.000030
Power Supply 9-15W IP20	500 mA	31x70x200 mm	35.92.00.000031
Power Supply 17-22W IP20	700 mA	31x70x200 mm	35.92.00.000032

> External Driver to be housed nearby.

**OPTIONS**

**LED**

2700 K, 5000 K, 6500 K  
 Tunable White, RGB, RGBW  
 CRI >90

**ELECTRICAL SYSTEM**

DSI, DIM 1-10V, Phase-cut

**CONTROL SYSTEM**

Bluetooth

**FINISHING**

Other Colours

**EMERGENCY**

1 Hour, 3 Hours  
 DALI 1 Hour, 3 Hours

**SENSORS**

Motion  
 Ambient Light  
 Motion & Ambient Light

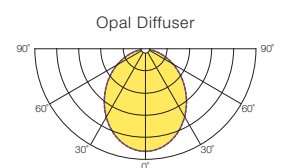
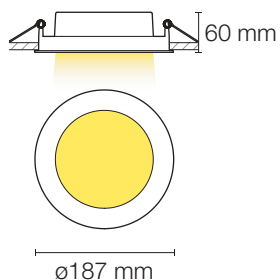

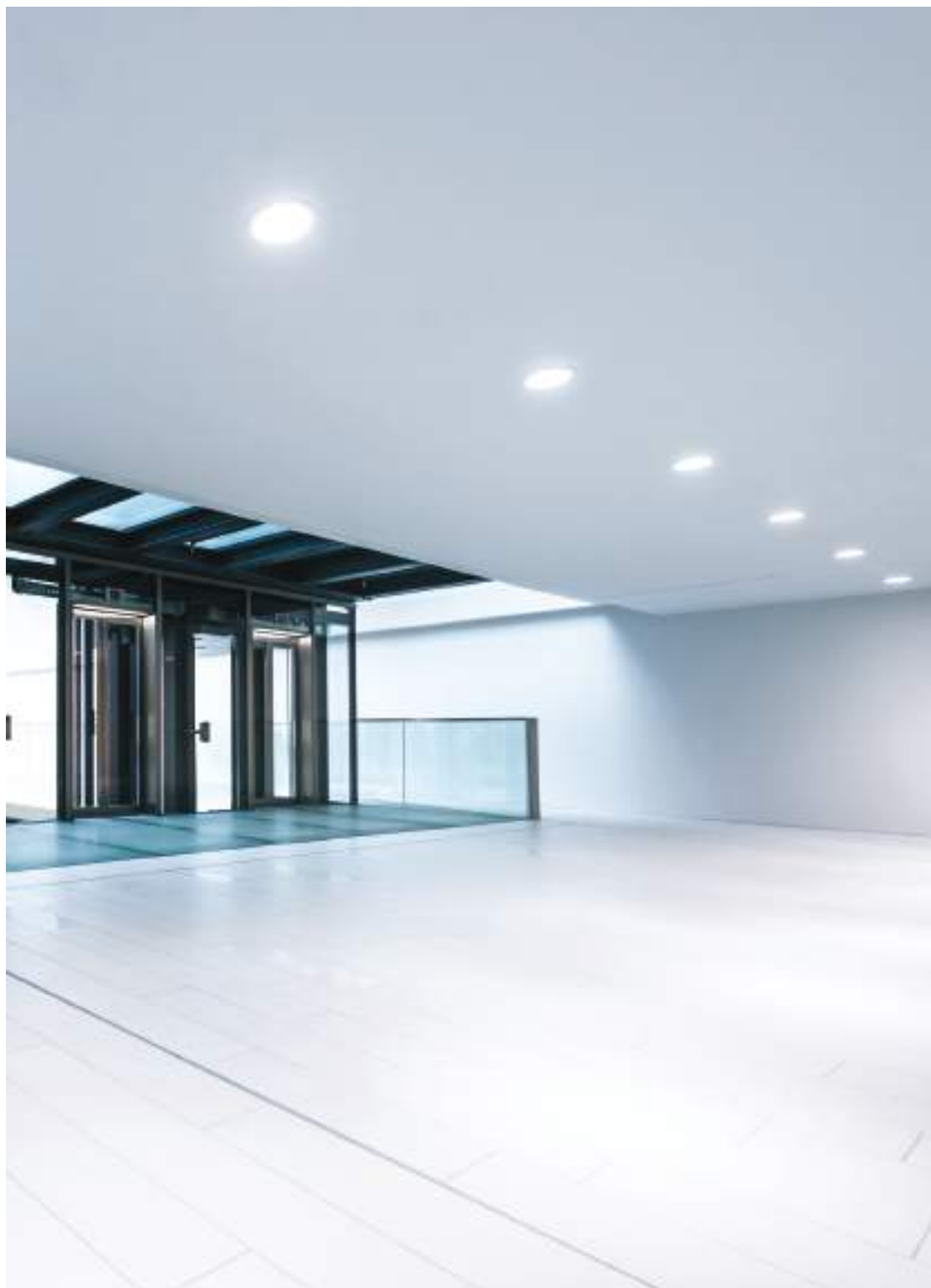

> **TALLES 187 RO** RECESSED



> **TALLES 200 SQ RECESSED**

# TALLES 200 SQ IP44

## RECESSED

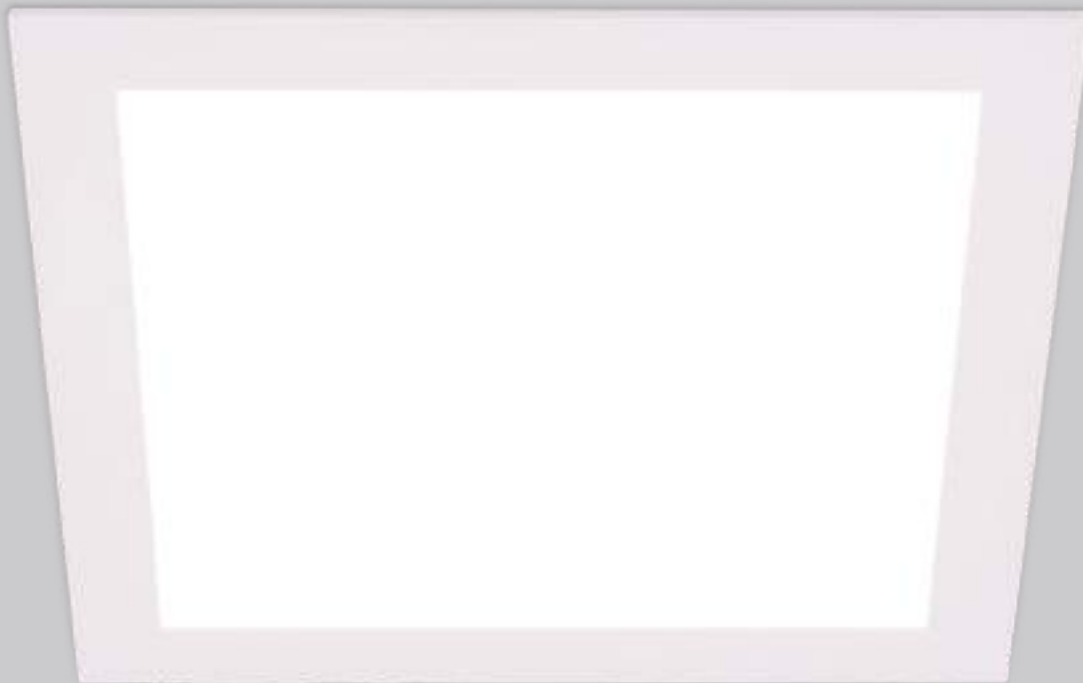

### PT

- > Downlight de luz homogénea para aplicação encastrada.
- > Proteção IP44 na face visível.
- > Com molas de fixação rápida para instalação sem ferramentas.
- > Adequado para instalação em tetos falsos com espessura entre 5 e 20 mm.
- > Driver externo de corrente constante e classe proteção II.
- > Difusor Policarbonato Opal para iluminação homogénea, difusa e eficiente.
- > Moldura de remate em alumínio com revestimento a epoxy-poliéster.

### ES

- > Downlight de luz homogénea para aplicación empotrada.
- > Protección IP44 en el cuerpo visible.
- > Con muelles de montaje rápido sin ayuda de herramientas.
- > Adecuado para la instalación en falsos techos con espesor entre 5 y 20 mm.
- > Driver externo de corriente constante y clase de protección II.
- > Difusor Policarbonato Opal.
- > Marco frontal en aluminio con recubrimiento epoxy-poliéster.



**QUICK INFO**

**GENERAL**

Recessed  
 IP44 (Optic)  
 IP20  
 IK06  
 850°C  
 Class III  
 Ta= -20°C +35°C

**OPTIC**

Opal Polycarbonate

**LED**

Efficacy up to 143 lm/W  
 3000 K, 4000 K  
 CRI >80  
 Lifetime 50 000 H  
 L80/B10 @Tc=65°C  
 500 mA, 700 mA

**ELECTRICAL SYSTEM**

230V/50Hz  
 ON/OFF, DALI

**FINISHING**

RAL 9003 Matt White  
 RAL 9005 Matt Black

**TALLES 200 SQ RECESSED  
 OPAL DIFFUSER**

**IP44**

Output (lm)	LED		MATT WHITE	MATT BLACK
	Power (W)	Current		
<b>3000 K</b>				
1150	17	500 mA	33.92.004.08.42	33.92.004.08.44
1533	24	700 mA	33.92.004.08.43	33.92.004.08.45
<b>4000 K</b>				
1225	17	500 mA	33.92.004.08.50	33.92.004.08.52
1633	24	700 mA	33.92.004.08.51	33.92.004.08.53

**COMPONENTS**

**DRIVER - EXTERNAL**

ON/OFF	Current	DIMENSION	COD
Power Supply 12-22W IP20	500 mA	31x70x200 mm	35.92.003.01.09
Power Supply 17-34W IP20	700 mA	31x70x215 mm	35.92.003.01.19

DALI	Current	DIMENSION	COD
Power Supply 12-22W IP20	500 mA	31x70x200 mm	35.92.003.01.12
Power Supply 21-31W IP20	700 mA	31x70x215 mm	35.92.003.01.20

> External Driver to be housed nearby.



CLASS II

**OPTIONS**

**LED**

2700 K, 5000 K, 6500 K  
 Tunable White, RGB, RGBW  
 CRI >90

**ELECTRICAL SYSTEM**

DSI, DIM 1-10V, Phase-cut

**CONTROL SYSTEM**

Bluetooth

**FINISHING**

Other Colours

**EMERGENCY**

1 Hour, 3 Hours  
 DALI 1 Hour, 3 Hours

**SENSORS**

Motion  
 Ambient Light  
 Motion & Ambient Light

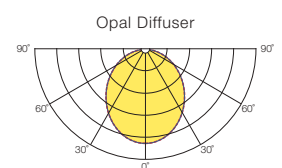
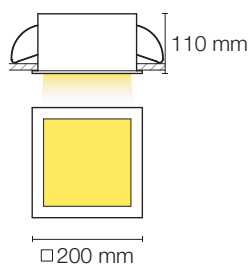

# ATLAS IP44

## RECESSED



### PT

- > Downlight de luz perfeitamente homogénea para aplicação encastrada no teto ou parede.
- > Disponível em cinco diâmetros standard.
- > Proteção IP44 na face visível.
- > Com molas de fixação rápida para instalação sem ferramentas.
- > Driver externo de corrente constante e classe proteção II.
- > Difusor Policarbonato Opal para iluminação homogénea, difusa e eficiente.
- > Corpo em alumínio com revestimento a epoxy-poliéster.

### ES

- > Downlight de luz perfectamente homogénea para instalación empotrada a techo o pared.
- > Disponible en cinco diámetros estándar.
- > Protección IP44 en el cuerpo visible.
- > Con muelles de montaje rápido sin ayuda de herramientas.
- > Driver externo de corriente constante y clase de protección II.
- > Difusor Policarbonato Opal.
- > Cuerpo en aluminio con recubrimiento epoxy-poliéster.

**QUICK INFO**

**GENERAL**

Recessed  
 IP44 (Optic)  
 IP20  
 IK07  
 850°C  
 Class III  
 Ta= -20°C +35°C

**OPTIC**

Opal Polycarbonate

**LED**

Efficacy up to 176 lm/W  
 3000 K, 4000 K  
 CRI >80  
 Lifetime 50 000 H  
 L80/B10 @Tc=65°C  
 150 mA, 350 mA, 500 mA  
 700 mA, 900 mA

**ELETRICAL SYSTEM**

230V/50Hz  
 ON/OFF, DALI

**FINISHING**

RAL 9016 Matt White

**OPTIONS**

**LED**

2700 K, 5000 K, 6500 K  
 Tunable White, RGB, RGBW  
 CRI >90

**ELECTRICAL SYSTEM**

DSI, DIM 1-10V, Phase-cut

**CONTROL SYSTEM**

Bluetooth

**EMERGENCY**

1 Hour, 3 Hours  
 DALI 1 Hour, 3 Hours

**SENSORS**

Motion  
 Ambient Light  
 Motion & Ambient Light

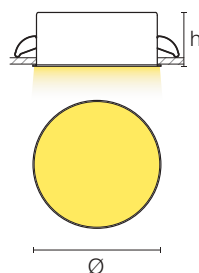

**ATLAS RECESSED**

**OPAL DIFFUSER**

**IP44**

Øxh (mm)	Output (lm)	LED Power (W)	LED Current	MATT WHITE
<b>3000 K</b>				
75x80	240	6	150 mA	33.76.000.08.27
150x100	913	12	350 mA	33.76.000.08.28
240x100	1668	19	500 mA	33.76.000.08.29
300x100	1695	25	700 mA	33.76.000.08.30
360x100	2239	34	900 mA	33.76.000.08.31
<b>4000 K</b>				
75x80	251	6	150 mA	33.76.000.08.32
150x100	962	12	350 mA	33.76.000.08.33
240x100	1844	19	500 mA	33.76.000.08.34
300x100	1806	25	700 mA	33.76.000.08.35
360x100	2385	34	900 mA	33.76.000.08.36

**COMPONENTS**

**DRIVER - EXTERNAL**



CLASS II

ON/OFF	Current	DIMENSION	COD
Power Supply 3-6W IP20	150 mA	30x43x97 mm	35.92.003.01.00
Power Supply 6-15W IP20	350 mA	31x70x215 mm	35.92.00.000027
Power Supply 19-31W IP20	500 mA	34x82x160 mm	35.92.003.01.22
Power Supply 17-34W IP20	700 mA	31x70x215 mm	35.92.003.01.19
Power Supply 22-40W IP20	900 mA	31x70x215 mm	35.92.003.01.23
DALI	Current	DIMENSION	COD
Power Supply 3-6W IP20	150 mA	30x43x130 mm	35.92.003.01.24
Power Supply 6-15W IP20	350 mA	31x70x200 mm	35.92.00.000030
Power Supply 12-22W IP20	500 mA	31x70x200 mm	35.92.003.01.12
Power Supply 21-31W IP20	700 mA	31x70x215 mm	35.92.003.01.20
Power Supply 27-41W IP20	900 mA	31x70x215 mm	35.92.003.01.25

> External Driver to be housed nearby.

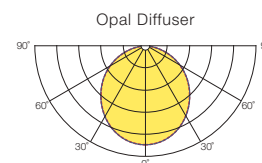



> **ATLAS** RECESSED

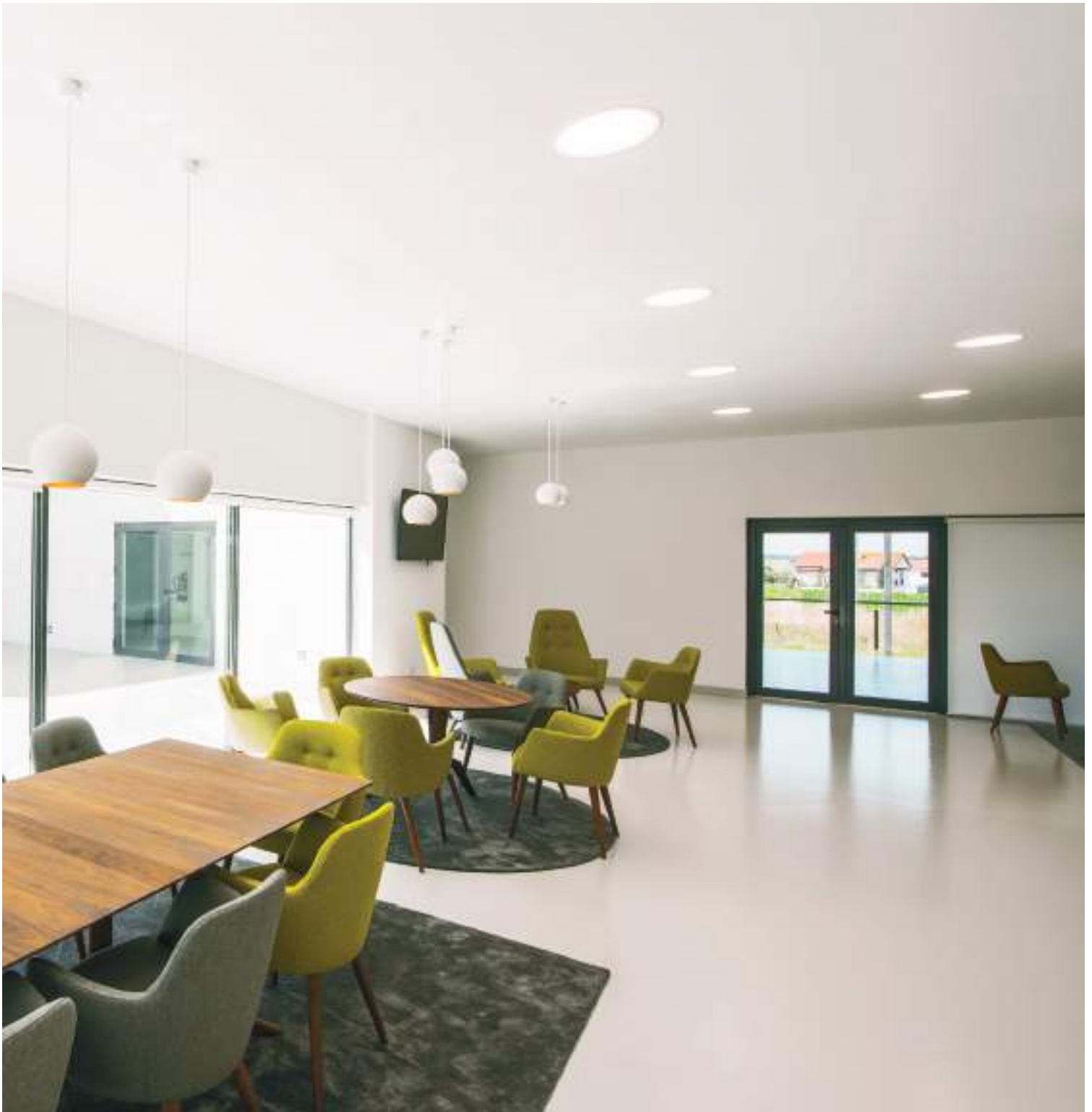

> **ATLAS** RECESSED

**TALLES**  
TRIMLESS



a  
10  
o



# TALLES 63 RO IN IP20, IP44

## TRIMLESS



### PT

- > Downlight compacto para aplicação encastrada sem aro de remate (trimless).
- > Para integração com o mínimo de impacto visual em tetos falsos de gesso cartonado.
- > Fonte de luz recuada para controlo do encandeamento e elevado conforto visual.
- > Três opções de lente – ângulo de abertura 20°, 35° ou 55°.
- > Disponível em versões IP20 ou com proteção IP44 equipada com difusor em vidro temperado.
- > Driver externo de corrente constante e classe proteção II.
- > Corpo em alumínio com revestimento a epoxy-poliéster.

### ES

- > Downlight compacto para aplicación empotrada sin marco de remate (trimless).
- > Para integración con el mínimo impacto visual en falsos techos de placas de yeso.
- > Posición reculada del LED para control del deslumbramiento y elevado confort visual.
- > Tres opciones de lente - ángulo de apertura 20°, 35° o 55°.
- > Disponible en versiones IP20 o con protección IP44 con difusor en vidrio templado.
- > Driver externo de corriente constante y clase de protección II.
- > Cuerpo en aluminio con recubrimiento epoxi-poliéster.



**QUICK INFO**

**GENERAL**

Trimless  
 IP20  
 650°C  
 Class III  
 Ta= -20°C +35°C

**LED**

Efficacy up to 170 lm/W  
 3000 K, 4000 K  
 CRI >80  
 Lifetime 72 000 H  
 L80/B10 @TC=65°C  
 150 mA, 200 mA, 250 mA

**ELETRICAL SYSTEM**

230V/50Hz  
 ON/OFF, DALI

**FINISHING**

RAL 9003 Matt White  
 RAL 9005 Matt Black

**OPTIONS**

**LED**

2700 K  
 CRI >90

**ELECTRICAL SYSTEM**

DSI, DIM 1-10V, Phase-cut

**CONTROL SYSTEM**

Bluetooth

**EMERGENCY**

1 Hour, 3 Hours  
 DALI 1 Hour, 3 Hours

**SENSORS**

Motion  
 Ambient Light  
 Motion & Ambient Light

**TALLES 63 RO IN TRIMLESS**

**IP20**

Beam Angle (°)	Output (lm)	LED Power (W)	LED Current	MATT WHITE	MATT BLACK
<b>3000 K</b>					
20°	560	5	150 mA	33.92.005.08.23	33.92.005.08.22
	717	7	200 mA	33.92.005.08.25	33.92.005.08.24
	866	8,7	250 mA	33.92.005.08.27	33.92.005.08.26
35°	548	5	150 mA	33.92.005.08.29	33.92.005.08.28
	702	7	200 mA	33.92.005.08.31	33.92.005.08.30
	848	8,7	250 mA	33.92.005.08.33	33.92.005.08.32
55°	547	5	150 mA	33.92.005.08.35	33.92.005.08.34
	701	7	200 mA	33.92.005.08.37	33.92.005.08.36
	847	8,7	250 mA	33.92.005.08.39	33.92.005.08.38
<b>4000 K</b>					
20°	697	5	150 mA	33.92.005.08.59	33.92.005.08.58
	910	7	200 mA	33.92.005.08.61	33.92.005.08.60
	1112	8,7	250 mA	33.92.005.08.63	33.92.005.08.62
35°	683	5	150 mA	33.92.005.08.65	33.92.005.08.64
	891	7	200 mA	33.92.005.08.67	33.92.005.08.66
	1089	8,7	250 mA	33.92.005.08.69	33.92.005.08.68
55°	682	5	150 mA	33.92.005.08.71	33.92.005.08.70
	890	7	200 mA	33.92.005.08.73	33.92.005.08.72
	1088	8,7	250 mA	33.92.005.08.75	33.92.005.08.74

**COMPONENTS**

**DRIVER - EXTERNAL**

ON/OFF	Current	DIMENSION	COD
Power Supply 1-5W IP20	150 mA	22x32x76 mm	35.92.000.08.50
Power Supply 1-7W IP20	200 mA	23x39x76 mm	35.92.000.08.51
Power Supply 1-9W IP20	250 mA	23x39x76 mm	35.92.000.08.52
DALI	Current	DIMENSION	COD
Power Supply 3-5W IP20	150 mA	30x43x160 mm	35.92.000.08.97
Power Supply 4-7W IP20	200 mA	30x43x160 mm	35.92.000.08.98
Power Supply 5-9W IP20	250 mA	30x43x160 mm	35.92.000.08.99

> External Driver to be housed nearby.



CLASS II

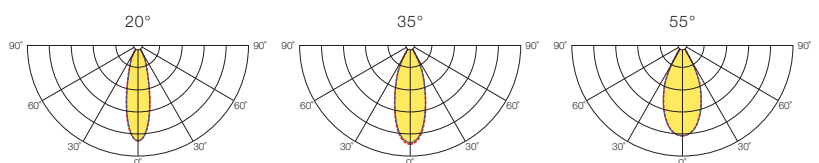
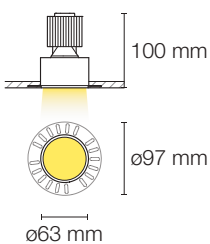

**QUICK INFO**

**GENERAL**

Trimless  
 IP44 (Optic)  
 IP20  
 IK06  
 960°C  
 Class III  
 Ta= -20°C +35°C

**LED**

Efficacy up to 170 lm/W  
 3000 K, 4000 K  
 CRI >80  
 Lifetime 72 000 H  
 L80/B10 @TC=65°C  
 150 mA, 200 mA, 250 mA

**ELETRICAL SYSTEM**

230V/50Hz  
 ON/OFF, DALI

**FINISHING**

RAL 9003 Matt White  
 RAL 9005 Matt Black

**OPTIONS**

**LED**

2700 K  
 CRI >90

**ELECTRICAL SYSTEM**

DSI, DIM 1-10V, Phase-cut

**CONTROL SYSTEM**

Bluetooth

**EMERGENCY**

1 Hour, 3 Hours  
 DALI 1 Hour, 3 Hours

**SENSORS**

Motion  
 Ambient Light  
 Motion & Ambient Light

**TALLES 63 RO IN TRIMLESS**

**IP44**

Beam Angle (°)	Output (lm)	LED Power (W)	LED Current	MATT WHITE	MATT BLACK
<b>3000 K</b>					
20°	521	5	150 mA	33.92.005.08.41	33.92.005.08.40
	667	7	200 mA	33.92.005.08.43	33.92.005.08.42
	805	8,7	250 mA	33.92.005.08.45	33.92.005.08.44
35°	510	5	150 mA	33.92.005.08.47	33.92.005.08.46
	653	7	200 mA	33.92.005.08.49	33.92.005.08.48
	789	8,7	250 mA	33.92.005.08.51	33.92.005.08.50
55°	509	5	150 mA	33.92.005.08.53	33.92.005.08.52
	652	7	200 mA	33.92.005.08.55	33.92.005.08.54
	788	8,7	250 mA	33.92.005.08.57	33.92.005.08.56
<b>4000 K</b>					
20°	648	5	150 mA	33.92.005.08.77	33.92.005.08.76
	847	7	200 mA	33.92.005.08.79	33.92.005.08.78
	1034	8,7	250 mA	33.92.005.08.81	33.92.005.08.80
35°	635	5	150 mA	33.92.005.08.83	33.92.005.08.82
	829	7	200 mA	33.92.005.08.85	33.92.005.08.84
	1013	8,7	250 mA	33.92.005.08.87	33.92.005.08.86
55°	634	5	150 mA	33.92.005.08.89	33.92.005.08.88
	828	7	200 mA	33.92.005.08.91	33.92.005.08.90
	1012	8,7	250 mA	33.92.005.08.93	33.92.005.08.92

**COMPONENTS**

**DRIVER - EXTERNAL**



CLASS II

ON/OFF	Current	DIMENSION	COD
Power Supply 1-5W IP20	150 mA	22x32x76 mm	35.92.000.08.50
Power Supply 1-7W IP20	200 mA	23x39x76 mm	35.92.000.08.51
Power Supply 1-9W IP20	250 mA	23x39x76 mm	35.92.000.08.52
DALI	Current	DIMENSION	COD
Power Supply 3-5W IP20	150 mA	30x43x160 mm	35.92.000.08.97
Power Supply 4-7W IP20	200 mA	30x43x160 mm	35.92.000.08.98
Power Supply 5-9W IP20	250 mA	30x43x160 mm	35.92.000.08.99

> External Driver to be housed nearby.

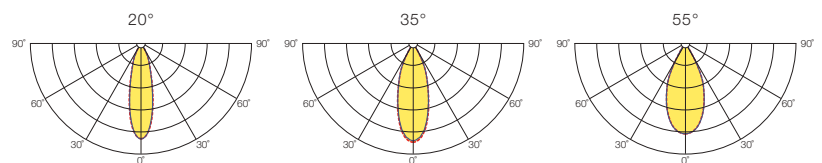
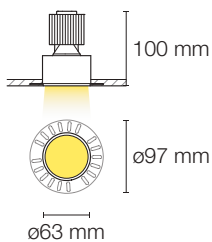



> ATLAS 95 RO TRIMLESS

# ATLAS RO IP44

## TRIMLESS



### PT

- > Downlight compacto para aplicação encastrada sem aro de remate (trimless).
- > Disponível em dois diâmetros standard (95 e 155).
- > Para integração com o mínimo de impacto visual em tetos falsos de gesso cartonado.
- > Difusor ajustável em duas posições distintas – à face com o teto ou recuado.
- > Sistema de fixação push-push que permite rapidez e facilidade de instalação.
- > Driver externo de corrente constante e classe proteção II.
- > Difusor PMMA Opal para iluminação homogénea, difusa e eficiente.
- > Corpo em alumínio injetado com revestimento a epoxy-poliéster.

### ES

- > Downlight compacto para aplicación empotrada sin marco de remate (trimless).
- > Disponible en dos diámetros estándar (95 y 155).
- > Para integración con el mínimo impacto visual en falsos techos de placas de yeso.
- > Difusor ajustable en dos posiciones - al ras con el techo o empotrado.
- > El sistema de fijación push-push permite el montaje rápido y sin esfuerzo.
- > Driver externo de corriente constante y clase de protección II.
- > Difusor PMMA Opal.
- > Cuerpo en aluminio inyectado con recubrimiento epoxi-poliéster.

RECESSED POSITION



FLUSH-FITTED POSITION



**QUICK INFO**

**GENERAL**

Trimless  
 IP44 (Optic)  
 IP20  
 650°C  
 Class III  
 Ta= -20°C +35°C

**OPTIC**

Opal PMMA

**LED**

Efficacy up to 175 lm/W  
 3000 K, 4000 K  
 CRI >80  
 Lifetime 50 000 H  
 L80/B10 @Tc=65°C  
 250 mA, 350 mA, 500 mA, 700mA

**ELETRICAL SYSTEM**

230V/50Hz  
 ON/OFF, DALI

**FINISHING**

RAL 9003 Matt White

**OPTIONS**

**LED**

2700 K, 5000 K, 6500 K  
 Tunable White, RGB, RGBW  
 CRI >90

**ELECTRICAL SYSTEM**

DSI, DIM 1-10V, Phase-cut

**CONTROL SYSTEM**

Bluetooth

**EMERGENCY**

1 Hour, 3 Hours  
 DALI 1 Hour, 3 Hours

**SENSORS**

Motion  
 Ambient Light  
 Motion & Ambient Light

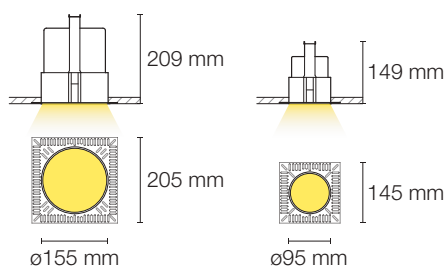

**ATLAS RO TRIMLESS  
 OPAL DIFFUSER**

**IP44**

Ø (mm)	Output (lm)	LED Power (W)	LED Current	MATT WHITE
<b>3000 K</b>				
95	373	8	250 mA	33.76.000.08.11
95	501	11	350 mA	33.76.000.08.12
155	1201	18	500 mA	33.76.000.08.19
155	1556	25	700 mA	33.76.000.08.20
<b>4000 K</b>				
95	385	8	250 mA	33.76.000.08.13
95	518	11	350 mA	33.76.000.08.14
155	1212	18	500 mA	33.76.000.08.21
155	1571	25	700 mA	33.76.000.08.22

**COMPONENTS**

**DRIVER - EXTERNAL**

ON/OFF	Current	DIMENSION	COD
Power Supply 1-9W IP20	250 mA	23x39x76 mm	35.92.000.08.52
Power Supply 6-15W IP20	350 mA	31x70x200 mm	35.92.00.000027
Power Supply 12-22W IP20	500 mA	31x70x200 mm	35.92.003.01.09
Power Supply 17-34W IP20	700 mA	31x70x215 mm	35.92.003.01.19

DALI	Current	DIMENSION	COD
Power Supply 4-9W IP20	250 mA	31x70x200 mm	35.92.003.01.10
Power Supply 6-15W IP20	350 mA	31x70x200 mm	35.92.00.000030
Power Supply 12-22W IP20	500 mA	31x70x200 mm	35.92.003.01.12
Power Supply 21-31W IP20	700 mA	31x70x215 mm	35.92.003.01.20

> External Driver to be housed nearby.



CLASS II

RECESSED POSITION FLUSH-FITTED POSITION

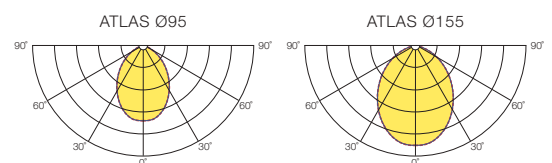

# ATLAS SQ IP44

## TRIMLESS

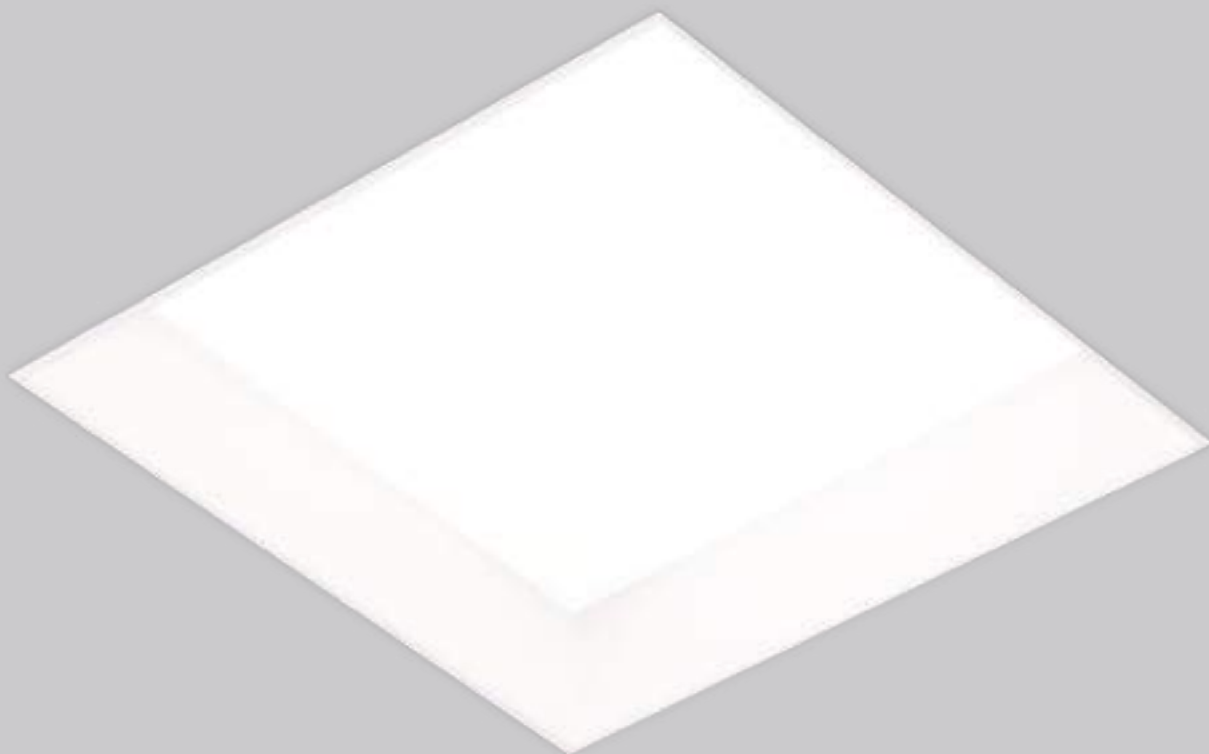

### PT

- > Downlight compacto para aplicação encastrada sem aro de remate (trimless).
- > Disponível em duas dimensões standard (95 e 155).
- > Para integração com o mínimo de impacto visual em tetos falsos de gesso cartonado.
- > Difusor ajustável em duas posições distintas – à face com o teto ou recuado.
- > Sistema de fixação push-push que permite rapidez e facilidade de instalação.
- > Driver externo de corrente constante e classe proteção II.
- > Difusor PMMA Opal para iluminação homogénea, difusa e eficiente.
- > Corpo em alumínio injetado com revestimento a epoxy-poliéster.

### ES

- > Downlight compacto para aplicación empotrada sin marco de remate (trimless).
- > Disponible en dos tamaños estándar (95 y 155).
- > Para integración con el mínimo impacto visual en falsos techos de placas de yeso.
- > Difusor ajustable en dos posiciones - al ras con el techo o empotrado.
- > El sistema de fijación push-push permite el montaje rápido y sin esfuerzo.
- > Driver externo de corriente constante y clase de protección II.
- > Difusor PMMA Opal.
- > Cuerpo en aluminio inyectado con recubrimiento epoxi-poliéster.

RECESSED POSITION

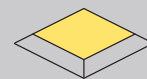

FLUSH-FITTED POSITION

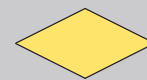

**QUICK INFO**

**GENERAL**

Trimless  
 IP44 (Optic)  
 IP20  
 650°C  
 Class III  
 Ta= -20°C +35°C

**OPTIC**

Opal PMMA

**LED**

Efficacy up to 175 lm/W  
 3000 K, 4000 K  
 CRI >80  
 Lifetime 50 000 H  
 L80/B10 @Tc=65°C  
 250 mA, 350 mA, 500 mA, 700mA

**ELETRICAL SYSTEM**

230V/50Hz  
 ON/OFF, DALI

**FINISHING**

RAL 9003 Matt White

**OPTIONS**

**LED**

2700 K, 5000 K, 6500 K  
 Tunable White, RGB, RGBW  
 CRI >90

**ELECTRICAL SYSTEM**

DSI, DIM 1-10V, Phase-cut

**CONTROL SYSTEM**

Bluetooth

**EMERGENCY**

1 Hour, 3 Hours  
 DALI 1 Hour, 3 Hours

**SENSORS**

Motion  
 Ambient Light  
 Motion & Ambient Light

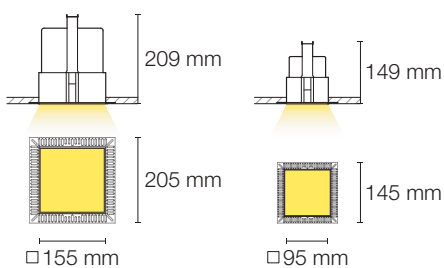

**ATLAS SQ TRIMLESS**

**OPAL DIFFUSER**

**IP44**

bxc (mm)	Output (lm)	LED Power (W)	LED Current	MATT WHITE
<b>3000 K</b>				
95x95	488	8	250 mA	33.76.000.08.15
95x95	656	11	350 mA	33.76.000.08.16
115x115	1227	18	500 mA	33.76.000.08.23
115x115	1590	25	700 mA	33.76.000.08.24
<b>4000 K</b>				
95x95	504	8	250 mA	33.76.000.08.17
95x95	677	11	350 mA	33.76.000.08.18
115x115	1239	18	500 mA	33.76.000.08.25
115x115	1605	25	700 mA	33.76.000.08.26

**COMPONENTS**

**DRIVER - EXTERNAL**



CLASS II

**ON/OFF**

ON/OFF	Current	DIMENSION	COD
Power Supply 1-9W IP20	250 mA	23x39x76 mm	35.92.000.08.52
Power Supply 6-15W IP20	350 mA	31x70x200 mm	35.92.00.000027
Power Supply 12-22W IP20	500 mA	31x70x200 mm	35.92.003.01.09
Power Supply 17-34W IP20	700 mA	31x70x215 mm	35.92.003.01.19

**DALI**

DALI	Current	DIMENSION	COD
Power Supply 4-9W IP20	250 mA	31x70x200 mm	35.92.003.01.10
Power Supply 6-15W IP20	350 mA	31x70x200 mm	35.92.00.000030
Power Supply 12-22W IP20	500 mA	31x70x200 mm	35.92.003.01.12
Power Supply 21-31W IP20	700 mA	31x70x215 mm	35.92.003.01.20

> External Driver to be housed nearby.

RECESSED POSITION

FLUSH-FITTED POSITION



ATLAS 95

ATLAS 155

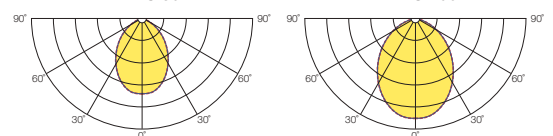

**TRACK & SPOTS**  
SUSPENDED







# TRACK SURFACE



## PT

- > Calha trifásica em perfil alumínio.
- > Adequado para aplicação suspensa ou saliente (no teto ou na parede).
- > Ampla gama de componentes de união que permitem a realização de estruturas lineares ou geométricas com várias configurações.
- > Permite aplicação de projetores equipados com adaptador universal trifásico.
- > Perfil de alumínio extrudido com revestimento a epoxy-poliéster.

## ES

- > Carril electrificado trifásico en perfil de aluminio.
- > Apropriado para aplicación suspendida o en superficie (en techo o pared).
- > Amplia gama de componentes de unión que permiten la realización de estructuras lineales o geométricas en varias configuraciones.
- > Permite la aplicación de proyectores equipados con adaptador universal para carril trifásico.
- > Perfil de aluminio extruido con recubrimiento epoxy-poliéster.

**QUICK INFO**

**GENERAL**

Suspended / Surface / Wall  
 IP20  
 Class I

**ELETRICAL SYSTEM**

230V/50Hz  
 16A/400V (max.)  
 ON/OFF - Ref. XTS  
 DALI - Ref. XTSC

**FINISHING**

RAL 9010 Matt White  
 RAL 9005 Matt Black

**OPTIONS**

**FINISHING**

Other Colours

**TRACK SURFACE**

**MATT WHITE FINISHING**

c (mm)	ON/OFF	DALI
3000	61.01.69.002.30	61.01.69.002.32

**MATT BLACK FINISHING**

c (mm)	ON/OFF	DALI
3000	61.01.69.002.31	61.01.69.002.33

**CONFIGURATIONS**

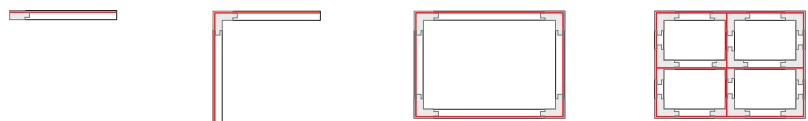

**APPLICATIONS**

**SUSPENDED**

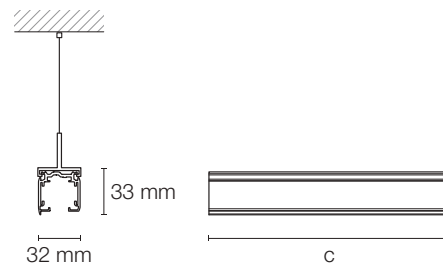

**SURFACE**

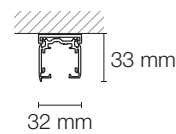

**WALL**

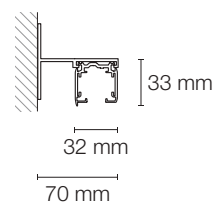

# TRACK SURFACE

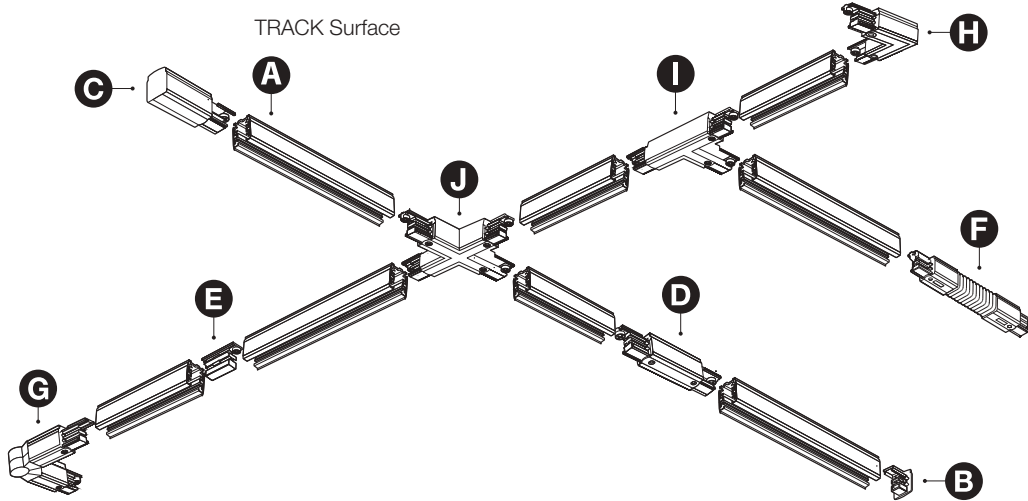

## DESCRIPTION

- > Red Line indicates polarity.
- > Feed Unit.

## COMPONENTS



<b>B</b> END CAP (1pc)		REF	MATT WHITE	REF	MATT BLACK
End Cap		XTS 41-3	61.01.69.002.89	XTS 41-2	61.01.69.002.88



<b>C</b> END FEED (1pc)		REF	MATT WHITE	REF	MATT BLACK
End Feed - Type 1	ON/OFF	XTS 11-3	61.01.69.002.39	XTS 11-2	61.01.69.002.38
	DALI	XTSC 611-3	61.01.69.002.43	XTSC 611-2	61.01.69.002.42
End Feed - Type 2	ON/OFF	XTS 12-3	61.01.69.002.41	XTS 12-2	61.01.69.002.40
	DALI	XTSC 612-3	61.01.69.002.45	XTSC 612-2	61.01.69.002.44



<b>D</b> MIDDLE FEED (1pc)		REF	MATT WHITE	REF	MATT BLACK
Middle Feed	ON/OFF	XTS 14-3	61.01.69.002.47	XTS 14-2	61.01.69.002.46
	DALI	XTSC 614-3	61.01.69.002.49	XTSC 614-2	61.01.69.002.48

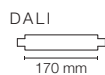

<b>E</b> STRAIGHT CONNECTOR (1pc)		REF	MATT WHITE	REF	MATT BLACK
Straight Connector	ON/OFF	XTS 21-3	61.01.69.002.51	XTS 21-2	61.01.69.002.50
	DALI	XTSC 621-3	61.01.69.002.53	XTSC 621-2	61.01.69.002.52



<b>F FLEXIBLE CONNECTOR (1pc)</b>		REF	MATT WHITE	REF	MATT BLACK
Flexible Corner Connector	ON/OFF	XTS 23-3	61.01.69.002.55	XTS 23-2	61.01.69.002.54
	DALI	XTSC 623-3	61.01.69.002.57	XTS 623-2	61.01.69.002.56

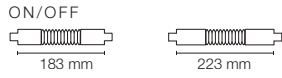

<b>G ADJUSTABLE CONNECTOR (1pc)</b>		REF	MATT WHITE	REF	MATT BLACK
Adjustable Corner Connector	ON/OFF	XTS 24-3	61.01.69.002.59	XTS 24-2	61.01.69.002.58



<b>H "L" FEED (1pc)</b>		REF	MATT WHITE	REF	MATT BLACK
⚡ "L" Feed Track Adapter - Type 1	ON/OFF	XTS 34-3	61.01.69.002.61	XTS 34-2	61.01.69.002.60
	DALI	XTSC 634-3	61.01.69.002.65	XTSC 634-2	61.01.69.002.64
⚡ "L" Feed Track Adapter - Type 2	ON/OFF	XTS 35-3	61.01.69.002.63	XTS 35-2	61.01.69.002.62
	DALI	XTSC 635-3	61.01.69.002.67	XTSC 635-2	61.01.69.002.66



<b>I "T" FEED (1pc)</b>		REF	MATT WHITE	REF	MATT BLACK
⚡ "T" Feed - Type 1	ON/OFF	XTS 36-3	61.01.69.002.69	XTS 36-2	61.01.69.002.68
	DALI	XTSC 636-3	61.01.69.002.77	XTSC 636-2	61.01.69.002.76
⚡ "T" Feed - Type 2	ON/OFF	XTS 37-3	61.01.69.002.71	XTS 37-2	61.01.69.002.70
	DALI	XTSC 637-3	61.01.69.002.79	XTSC 637-2	61.01.69.002.78
⚡ "T" Feed - Type 3	ON/OFF	XTS 39-3	61.01.69.002.73	XTS 39-2	61.01.69.002.72
	DALI	XTSC 639-3	61.01.69.002.81	XTSC 639-2	61.01.69.002.80
⚡ "T" Feed - Type 4	ON/OFF	XTS 40-3	61.01.69.002.75	XTS 40-2	61.01.69.002.74
	DALI	XTSC 640-3	61.01.69.002.83	XTSC 640-2	61.01.69.002.82

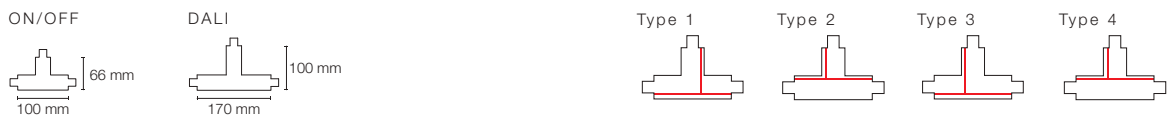

<b>J "X" FEED (1pc)</b>		REF	MATT WHITE	REF	MATT BLACK
⚡ "X" Feed	ON/OFF	XTS 38-3	61.01.69.002.85	XTS 38-2	61.01.69.002.84
	DALI	XTS 638-3	61.01.69.002.87	XTS 638-2	61.01.69.002.86



<b>COVER STRIP (1pc)</b>		REF	MATT WHITE	REF	MATT BLACK
Cover Strip 3000mm		XTSP 11-3	61.01.69.003.00	XTSP 11-2	61.01.69.002.99

# TRACK SURFACE

## COMPONENTS



<b>STANDARD CLAMP (1pc)</b>		<b>REF</b>	<b>MATT WHITE</b>	<b>REF</b>	<b>MATT BLACK</b>
Standard Clamp		SKB 12-3	61.01.69.003.02	SKB 12-2	61.01.69.003.01



<b>SUSPENSION CLAMP (1pc)</b>		<b>REF</b>	<b>MATT WHITE</b>	<b>REF</b>	<b>MATT BLACK</b>
Suspension Clamp		SKB 16-3	61.01.69.003.04	SKB 16-2	61.01.69.003.03



<b>WALL CLAMP (1pc)</b>		<b>REF</b>	<b>ANODIZED</b>
Wall Clamp		SKB 21-1	61.01.69.003.05



<b>BENDING TOOL (1pc)</b>		<b>REF</b>	<b>COD</b>
Bending Tool		XTSV 12	61.01.00.008.69



<b>RECESSED CEILING CUP (1pc)</b>		<b>DIMENSION</b>	<b>1m</b>	<b>3m</b>	<b>5m</b>
<b>MATT WHITE</b>					
ON/OFF	Ø80 mm	35.42.001.01.84	35.42.001.01.92	35.42.002.01.00	
DALI	Ø80 mm	35.42.001.01.86	35.42.001.01.94	35.42.002.01.02	



<b>SURFACE CEILING CUP (1pc)</b>		<b>DIMENSION</b>	<b>1m</b>	<b>3m</b>	<b>5m</b>
<b>MATT WHITE</b>					
ON/OFF	Ø62x36 mm	35.42.001.01.80	35.42.001.01.88	35.42.001.01.96	
DALI	Ø62x36 mm	35.42.001.01.82	35.42.001.01.90	35.42.001.01.98	



<b>SUSPENSION SYSTEM (2pcs)</b>		<b>1m</b>	<b>3m</b>	<b>5m</b>
<b>TYPE</b>				
Matt White + Stainless Steel Cable		35.69.001.00.03	35.69.001.00.09	35.69.001.00.10



> TRACK SURFACE

# TRACK

## RECESSED



### PT

- > Calha trifásica em perfil alumínio.
- > De aplicação encastrada.
- > Ampla gama de componentes de união que permitem a realização de estruturas lineares ou geométricas com várias configurações.
- > Permite aplicação de projetores equipados com adaptador universal trifásico.
- > Perfil de alumínio extrudido com revestimento a epoxy-poliéster.

### ES

- > Carril electrificado trifásico en perfil de aluminio.
- > Para aplicación empotrada.
- > Amplia gama de componentes de unión que permiten la realización de estructuras lineales o geométricas en varias configuraciones.
- > Permite la aplicación de proyectores equipados con adaptador universal para carril trifásico.
- > Perfil de aluminio extruido con recubrimiento epoxy-poliéster.



**QUICK INFO**

**GENERAL**

Recessed  
IP20  
Class I

**ELETRICAL SYSTEM**

230V/50Hz  
16A/400V (max.)  
ON/OFF - Ref. XTSCF  
DALI - Ref. XTSCF

**FINISHING**

RAL 9010 Matt White  
RAL 9005 Matt Black

**OPTIONS**

**FINISHING**

Other Colours

**TRACK RECESSED**

**MATT WHITE FINISHING**

c (mm)	ON/OFF	DALI
3000	61.01.69.002.34	61.01.69.002.36

**MATT BLACK FINISHING**

c (mm)	ON/OFF	DALI
3000	61.01.69.002.35	61.01.69.002.37

**CONFIGURATIONS**

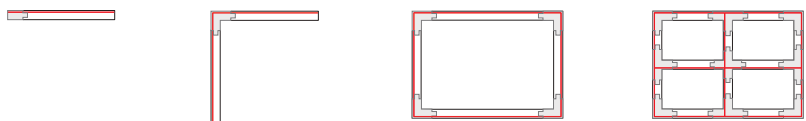

**APPLICATION**

RECESSED

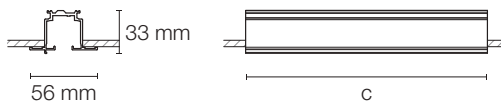

**ON/OFF**

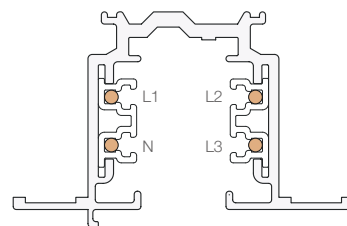

**DALI**

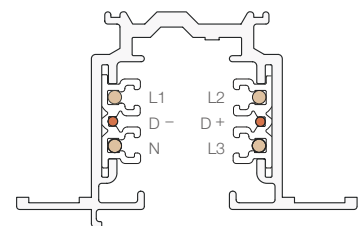

# TRACK RECESSED

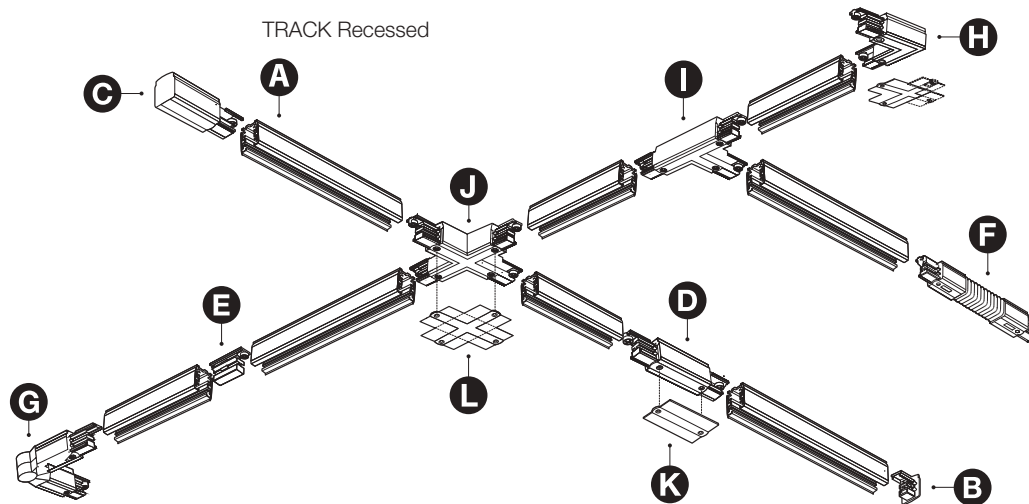

## DESCRIPTION

- > Red Line indicates polarity.
- > Feed Unit.

## COMPONENTS



<b>B</b> END CAP (1pc)		REF	MATT WHITE	REF	MATT BLACK
End Cap		XTS 41-3	61.01.69.002.89	XTS 41-2	61.01.69.002.88



<b>C</b> END FEED (1pc)		REF	MATT WHITE	REF	MATT BLACK
End Feed - Type 1	ON/OFF	XTS 11-3	61.01.69.002.39	XTS 11-2	61.01.69.002.38
	DALI	XTSC 611-3	61.01.69.002.43	XTSC 611-2	61.01.69.002.42
End Feed - Type 2	ON/OFF	XTS 12-3	61.01.69.002.41	XTS 12-2	61.01.69.002.40
	DALI	XTSC 612-3	61.01.69.002.45	XTSC 612-2	61.01.69.002.44



<b>D</b> MIDDLE FEED (1pc)		REF	MATT WHITE	REF	MATT BLACK
Middle Feed	ON/OFF	XTS 14-3	61.01.69.002.47	XTS 14-2	61.01.69.002.46
	DALI	XTSC 614-3	61.01.69.002.49	XTSC 614-2	61.01.69.002.48



<b>E</b> STRAIGHT CONNECTOR (1pc)		REF	MATT WHITE	REF	MATT BLACK
Straight Connector	ON/OFF	XTS 21-3	61.01.69.002.51	XTS 21-2	61.01.69.002.50
	DALI	XTSC 621-3	61.01.69.002.53	XTSC 621-2	61.01.69.002.52



<b>F FLEXIBLE CONNECTOR (1pc)</b>		REF	MATT WHITE	REF	MATT BLACK
Flexible Corner Connector	ON/OFF	XTS 23-3	61.01.69.002.55	XTS 23-2	61.01.69.002.54
	DALI	XTSC 623-3	61.01.69.002.57	XTS 623-2	61.01.69.002.56

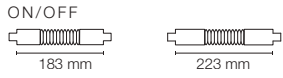

<b>G ADJUSTABLE CONNECTOR (1pc)</b>		REF	MATT WHITE	REF	MATT BLACK
Adjustable Corner Connector	ON/OFF	XTS 24-3	61.01.69.002.59	XTS 24-2	61.01.69.002.58



<b>H "L" FEED (1pc)</b>		REF	MATT WHITE	REF	MATT BLACK
⚡ "L" Feed Track Adapter - Type 1	ON/OFF	XTS 34-3	61.01.69.002.61	XTS 34-2	61.01.69.002.60
	DALI	XTSC 634-3	61.01.69.002.65	XTSC 634-2	61.01.69.002.64
⚡ "L" Feed Track Adapter - Type 2	ON/OFF	XTS 35-3	61.01.69.002.63	XTS 35-2	61.01.69.002.62
	DALI	XTSC 635-3	61.01.69.002.67	XTSC 635-2	61.01.69.002.66

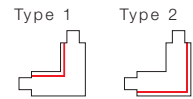
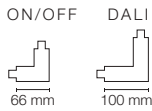

<b>I "T" FEED (1pc)</b>		REF	MATT WHITE	REF	MATT BLACK
⚡ "T" Feed - Type 1	ON/OFF	XTS 36-3	61.01.69.002.69	XTS 36-2	61.01.69.002.68
	DALI	XTSC 636-3	61.01.69.002.77	XTSC 636-2	61.01.69.002.76
⚡ "T" Feed - Type 2	ON/OFF	XTS 37-3	61.01.69.002.71	XTS 37-2	61.01.69.002.70
	DALI	XTSC 637-3	61.01.69.002.79	XTSC 637-2	61.01.69.002.78
⚡ "T" Feed - Type 3	ON/OFF	XTS 39-3	61.01.69.002.73	XTS 39-2	61.01.69.002.72
	DALI	XTSC 639-3	61.01.69.002.81	XTSC 639-2	61.01.69.002.80
⚡ "T" Feed - Type 4	ON/OFF	XTS 40-3	61.01.69.002.75	XTS 40-2	61.01.69.002.74
	DALI	XTSC 640-3	61.01.69.002.83	XTSC 640-2	61.01.69.002.82

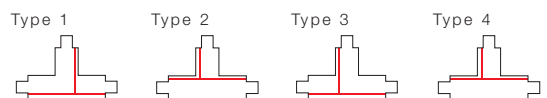
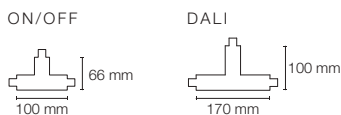

<b>J "X" FEED (1pc)</b>		REF	MATT WHITE	REF	MATT BLACK
⚡ "X" Feed	ON/OFF	XTS 38-3	61.01.69.002.85	XTS 38-2	61.01.69.002.84
	DALI	XTS 638-3	61.01.69.002.87	XTS 638-2	61.01.69.002.86

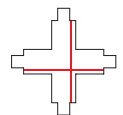

<b>COVER STRIP (1pc)</b>		REF	MATT WHITE	REF	MATT BLACK
Cover Strip 3000mm		XTSP 11-3	61.01.69.003.00	XTSP 11-2	61.01.69.002.99

# TRACK RECESSED

## COMPONENTS



<b>K</b> LINEAR COVER (1pc)		REF	MATT WHITE	REF	MATT BLACK
Linear Cover Plate	ON/OFF	XTS 10-3	61.01.69.002.92	XTS 10-2	61.01.69.002.91
	DALI	XTS 610-3	61.01.69.002.94	XTS 610-2	61.01.69.002.93



<b>L</b> COVER (1pc)		REF	MATT WHITE	REF	MATT BLACK
Cover Plate	ON/OFF	XTS 30-3	61.01.69.002.96	XTS 30-2	61.01.69.002.95
	DALI	XTS 630-3	61.01.69.002.98	XTS 630-2	61.01.69.002.97

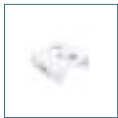

STANDARD CLAMP (1pc)		REF	MATT WHITE	REF	MATT BLACK
Standard Clamp		SKB 12-3	61.01.69.003.02	SKB 12-2	61.01.69.003.01



RECESSED CLAMP (1pc)			MATT WHITE
Recessed Clamp			35.69.001.00.11



BENDING TOOL (1pc)		REF	COD
Bending Tool		XTSV 12	61.01.00.008.69



> TRACK RECESSED

# MIRO 60

## TRACK



### PT

- > Projetor orientável em dois eixos para aplicação em calha trifásica.
- > Orientável em 355° de rotação e 90° de inclinação.
- > Com adaptador universal para instalação sem ferramentas numa variedade de calhas trifásicas.
- > Corpo em alumínio com acabamento texturado.

### ES

- > Proyector orientable en dos ejes para aplicación en carril trifásico.
- > Orientable con rotación de 355° y basculación de 90°.
- > Con adaptador universal para instalación sin herramientas en diferentes carriles trifásicos.
- > Cuerpo en aluminio con acabado texturado.

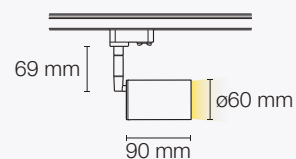

**QUICK INFO**

**GENERAL**

Track  
 IP20  
 960°C  
 Class I  
 Ta= -20°C +35°C

**LAMP - NOT INCLUDED**

GU10

**ELETRICAL SYSTEM**

230V/50Hz  
 ON/OFF

**FINISHING**

RAL 9003 Matt White  
 RAL 9005 Matt Black

**MIRO 60 TRACK - LAMP**

Type	Lamp Power (W)	MATT WHITE	MATT BLACK
<b>IP20</b>			
GU10	max. 50	33.06.60.000065	33.06.60.000066

> Lamp not included.  
 > 3-phase track universal adapter included.

**RECOMENDED LAMPS**



**OSRAM**  
 PARATHOM  
 PAR 16  
 GU10  
 6,9 W



**PHILIPS**  
 Corepro  
 LEDspot  
 GU10  
 7 W

**OPTIONS**

**FINISHING**

Other Colours



**ROTATION**

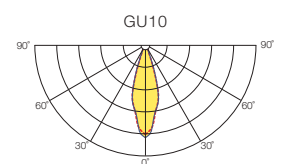
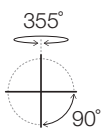

Lamp: 50W 35° HAL (GU10).

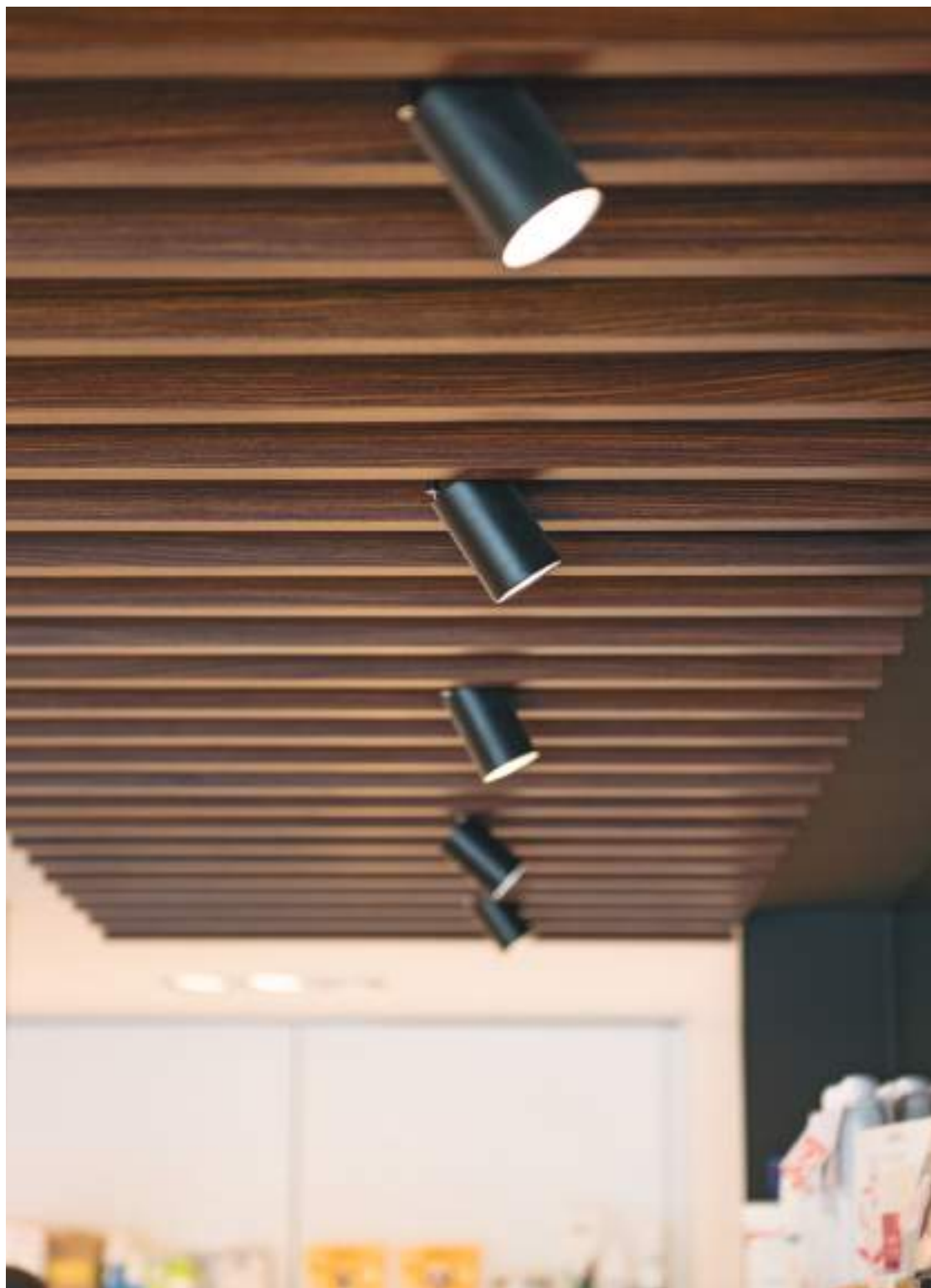

> **MIRO 60** TRACK





> MIRO 60 TRACK

# MIRO 80

## TRACK



### PT

- > Projetor orientável em dois eixos para aplicação em calha trifásica.
- > Orientável em 355° de rotação e 90° de inclinação.
- > Versões CRI >80 ou CRI >90 com elevada restituição cromática.
- > Três opções de ângulo de abertura do feixe: 19°, 33° ou 56°.
- > Com adaptador universal para instalação sem ferramentas numa variedade de calhas trifásicas.
- > Refletor em alumínio Miro-Silver® de elevada eficiência.
- > Corpo em alumínio com acabamento texturado.

### ES

- > Proyector orientable en dos ejes para aplicación en carril trifásico.
- > Orientable con rotación de 355° y basculación de 90°.
- > Versiones CRI >80 o CRI >90 para muy buena reproducción del color.
- > Tres opciones de ángulo de emisión: 19°, 33° o 56°.
- > Con adaptador universal para instalación sin herramientas en diferentes carriles trifásicos.
- > Reflector en aluminio Miro-Silver® de alta eficiencia.
- > Cuerpo en aluminio con acabado texturado.

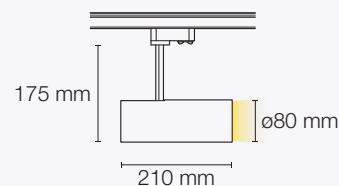

**QUICK INFO**

**GENERAL**

Track  
 IP20  
 650°C  
 Class I  
 Ta= -20°C +35°C

**OPTIC**

Aluminium Reflector

**LED**

Efficacy up to 169 lm/W  
 3000 K, 4000 K  
 CRI >80, CRI >90  
 Lifetime 50 000 H  
 L80/B10 @TC=65°C

**ELETRICAL SYSTEM**

230V/50Hz  
 ON/OFF, DALI

**FINISHING**

RAL 9003 Matt White

**MIRO 80 TRACK**

**MATT WHITE FINISHING**

CRI>80

Beam Angle (°)	Output (lm)	System (W)	ON/OFF	DALI
<b>3000 K</b>				
19°	2388	18	33.06.60.000171	33.06.60.000187
	3200	26	33.06.60.000173	33.06.60.000189
33°	2412	18	33.06.60.000172	33.06.60.000188
	3232	26	33.06.60.000174	33.06.60.000190
56°	2296	18	33.06.60.000715	33.06.60.000723
	3076	26	33.06.60.000716	33.06.60.000724
<b>4000 K</b>				
19°	2486	18	33.06.60.000203	33.06.60.000219
	3330	26	33.06.60.000205	33.06.60.000221
33°	2510	18	33.06.60.000204	33.06.60.000220
	3362	26	33.06.60.000206	33.06.60.000222
56°	2390	18	33.06.60.000731	33.06.60.000739
	3201	26	33.06.60.000732	33.06.60.000740

**OPTIONS**

**LED**

2700 K, 5000 K, 5700 K

**FINISHING**

Other Colours

CRI>90

Beam Angle (°)	Output (lm)	System (W)	ON/OFF	DALI
<b>3000 K</b>				
19°	1967	18	33.06.60.000179	33.06.60.000195
	2636	26	33.06.60.000181	33.06.60.000197
33°	1987	18	33.06.60.000180	33.06.60.000196
	2662	26	33.06.60.000182	33.06.60.000198
56°	1891	18	33.06.60.000719	33.06.60.000727
	2534	26	33.06.60.000720	33.06.60.000728
<b>4000 K</b>				
19°	2143	18	33.06.60.000211	33.06.60.000227
	2886	26	33.06.60.000213	33.06.60.000229
33°	2164	18	33.06.60.000212	33.06.60.000228
	2914	26	33.06.60.000214	33.06.60.000230
56°	2060	18	33.06.60.000735	33.06.60.000743
	2774	26	33.06.60.000736	33.06.60.000744

> Ready to use - driver and 3-phase track universal adapter included.



**ROTATION**

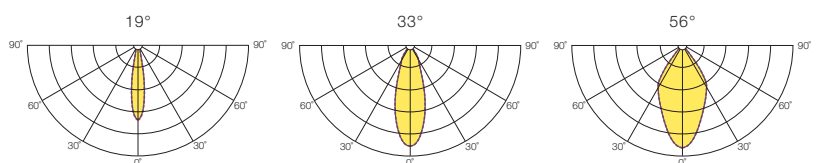
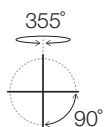

**QUICK INFO**

**GENERAL**

Track  
 IP20  
 650°C  
 Class I  
 Ta= -20°C +35°C

**OPTIC**

Aluminium Reflector

**LED**

Efficacy up to 169 lm/W  
 3000 K, 4000 K  
 CRI >80, CRI >90  
 Lifetime 50 000 H  
 L80/B10 @TC=65°C

**ELETRICAL SYSTEM**

230V/50Hz  
 ON/OFF, DALI

**FINISHING**

RAL 9005 Matt Black

**MIRO 80 TRACK**

**MATT BLACK FINISHING**

CRI >80

Beam Angle (°)	Output (lm)	System (W)	ON/OFF	DALI
<b>3000 K</b>				
19°	2388	18	33.06.60.000175	33.06.60.000191
	3200	26	33.06.60.000177	33.06.60.000193
33°	2412	18	33.06.60.000176	33.06.60.000192
	3232	26	33.06.60.000178	33.06.60.000194
56°	2296	18	33.06.60.000717	33.06.60.000725
	3076	26	33.06.60.000718	33.06.60.000726
<b>4000 K</b>				
19°	2486	18	33.06.60.000207	33.06.60.000223
	3330	26	33.06.60.000209	33.06.60.000225
33°	2510	18	33.06.60.000208	33.06.60.000224
	3362	26	33.06.60.000210	33.06.60.000226
56°	2390	18	33.06.60.000733	33.06.60.000741
	3201	26	33.06.60.000734	33.06.60.000742

**OPTIONS**

**LED**

2700 K, 5000 K, 5700 K

**FINISHING**

Other Colours

CRI >90

Beam Angle (°)	Output (lm)	System (W)	ON/OFF	DALI
<b>3000 K</b>				
19°	1967	18	33.06.60.000183	33.06.60.000199
	2636	26	33.06.60.000185	33.06.60.000201
33°	1987	18	33.06.60.000184	33.06.60.000200
	2662	26	33.06.60.000186	33.06.60.000202
56°	1891	18	33.06.60.000721	33.06.60.000729
	2534	26	33.06.60.000722	33.06.60.000730
<b>4000 K</b>				
19°	2143	18	33.06.60.000215	33.06.60.000231
	2886	26	33.06.60.000217	33.06.60.000233
33°	2164	18	33.06.60.000216	33.06.60.000232
	2914	26	33.06.60.000218	33.06.60.000234
56°	2060	18	33.06.60.000737	33.06.60.000745
	2774	26	33.06.60.000738	33.06.60.000746

> Ready to use - driver and 3-phase track universal adapter included.

**REFLECTORS**





> MIRO 80 TRACK

# MIRO 90

## TRACK



### PT

- > Projetor orientável em dois eixos para aplicação em calha trifásica.
- > Orientável em 355° de rotação e 90° de inclinação.
- > Versões CRI >80 ou CRI >90 com elevada restituição cromática.
- > Três opções de ângulo de abertura do feixe: 19°, 33° ou 56°.
- > Com adaptador universal para instalação sem ferramentas numa variedade de calhas trifásicas.
- > Refletor em alumínio Miro-Silver® de elevada eficiência.
- > Corpo em alumínio com acabamento texturado.

### ES

- > Proyector orientable en dos ejes para aplicación en carril trifásico.
- > Orientable con rotación de 355° y basculación de 90°.
- > Versiones CRI >80 o CRI >90 para muy buena reproducción del color.
- > Tres opciones de ángulo de emisión: 19°, 33° o 56°.
- > Con adaptador universal para instalación sin herramientas en diferentes carriles trifásicos.
- > Reflector en aluminio Miro-Silver® de alta eficiencia.
- > Cuerpo en aluminio con acabado texturado.

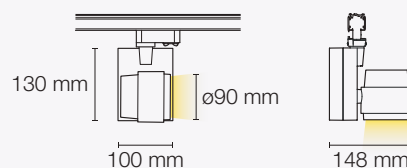

**QUICK INFO**

**GENERAL**

Track  
 IP20  
 650°C  
 Class I  
 Ta= -20°C +35°C

**OPTIC**

Aluminium Reflector

**LED**

Efficacy up to 175 lm/W  
 3000 K, 4000 K  
 CRI >80, CRI >90  
 Lifetime 50 000 H  
 L80/B10 @TC=65°C

**ELETRICAL SYSTEM**

230V/50Hz  
 ON/OFF, DALI

**FINISHING**

RAL 9003 Matt White

CRI>80

**MIRO 90 TRACK**

**MATT WHITE FINISHING**

Beam Angle (°)	Output (lm)	System (W)	ON/OFF	DALI
<b>3000 K</b>				
19°	1988	14	33.06.60.000235	33.06.60.000271
	2858	22	33.06.60.000238	33.06.60.000274
33°	1982	14	33.06.60.000236	33.06.60.000272
	2850	22	33.06.60.000239	33.06.60.000275
56°	1969	14	33.06.60.000237	33.06.60.000273
	2831	22	33.06.60.000240	33.06.60.000276
<b>4000 K</b>				
19°	2029	14	33.06.60.000307	33.06.60.000343
	2918	22	33.06.60.000310	33.06.60.000346
33°	2049	14	33.06.60.000308	33.06.60.000344
	2947	22	33.06.60.000311	33.06.60.000347
56°	1950	14	33.06.60.000309	33.06.60.000345
	2805	22	33.06.60.000312	33.06.60.000348

**OPTIONS**

**LED**

2700 K, 5000 K, 5700 K

**FINISHING**

Other Colours

CRI>90

Beam Angle (°)	Output (lm)	System (W)	ON/OFF	DALI
<b>3000 K</b>				
19°	1637	14	33.06.60.000253	33.06.60.000289
	2353	22	33.06.60.000256	33.06.60.000292
33°	1633	14	33.06.60.000254	33.06.60.000290
	2347	22	33.06.60.000257	33.06.60.000293
56°	1622	14	33.06.60.000255	33.06.60.000291
	2331	22	33.06.60.000258	33.06.60.000294
<b>4000 K</b>				
19°	1746	14	33.06.60.000325	33.06.60.000361
	2522	22	33.06.60.000328	33.06.60.000364
33°	1764	14	33.06.60.000326	33.06.60.000362
	2547	22	33.06.60.000329	33.06.60.000365
56°	1679	14	33.06.60.000327	33.06.60.000363
	2425	22	33.06.60.000330	33.06.60.000366

> Ready to use - driver and 3-phase track universal adapter included.



**ROTATION**

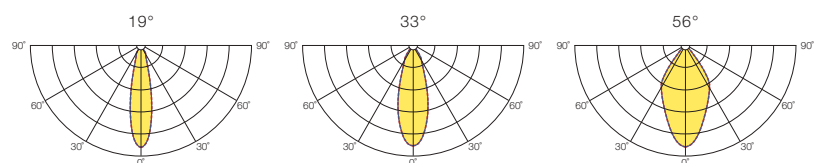
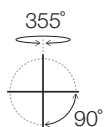

**QUICK INFO**

**GENERAL**

Track  
 IP20  
 650°C  
 Class I  
 Ta= -20°C +35°C

**OPTIC**

Aluminium Reflector

**LED**

Efficacy up to 175 lm/W  
 3000 K, 4000 K  
 CRI >80, CRI >90  
 Lifetime 50 000 H  
 L80/B10 @TC=65°C

**ELETRICAL SYSTEM**

230V/50Hz  
 ON/OFF, DALI

**FINISHING**

RAL 9005 Matt Black

CRI >80

**MIRO 90 TRACK**

**MATT BLACK FINISHING**

Beam Angle (°)	Output (lm)	System (W)	ON/OFF	DALI
<b>3000 K</b>				
19°	1988	14	33.06.60.000241	33.06.60.000277
	2858	22	33.06.60.000244	33.06.60.000280
33°	1982	14	33.06.60.000242	33.06.60.000278
	2850	22	33.06.60.000245	33.06.60.000281
56°	1969	14	33.06.60.000243	33.06.60.000279
	2831	22	33.06.60.000246	33.06.60.000282
<b>4000 K</b>				
19°	2029	14	33.06.60.000313	33.06.60.000349
	2918	22	33.06.60.000316	33.06.60.000352
33°	2049	14	33.06.60.000314	33.06.60.000350
	2947	22	33.06.60.000317	33.06.60.000353
56°	1950	14	33.06.60.000315	33.06.60.000351
	2805	22	33.06.60.000318	33.06.60.000354

**OPTIONS**

**LED**

2700 K, 5000 K, 5700 K

**FINISHING**

Other Colours

CRI >90

Beam Angle (°)	Output (lm)	System (W)	ON/OFF	DALI
<b>3000 K</b>				
19°	1637	14	33.06.60.000259	33.06.60.000295
	2353	22	33.06.60.000262	33.06.60.000298
33°	1633	14	33.06.60.000260	33.06.60.000296
	2347	22	33.06.60.000263	33.06.60.000299
56°	1622	14	33.06.60.000261	33.06.60.000297
	2331	22	33.06.60.000264	33.06.60.000300
<b>4000 K</b>				
19°	1746	14	33.06.60.000331	33.06.60.000367
	2522	22	33.06.60.000334	33.06.60.000370
33°	1764	14	33.06.60.000332	33.06.60.000368
	2547	22	33.06.60.000335	33.06.60.000371
56°	1679	14	33.06.60.000333	33.06.60.000369
	2425	22	33.06.60.000336	33.06.60.000372

> Ready to use - driver and 3-phase track universal adapter included.



**REFLECTORS**

19°

33°

56°





## QUICK INFO

## GENERAL

Track  
IP20  
650°C  
Class I  
Ta= -20°C +35°C

## OPTIC

Aluminium Reflector

## LED

Efficacy up to 175 lm/W  
3000 K, 4000 K  
CRI >80, CRI >90  
Lifetime 50 000 H  
L80/B10 @TC=65°C

## ELETRICAL SYSTEM

230V/50Hz  
ON/OFF, DALI

## FINISHING

RAL 9003 Matt White  
RAL 9005 Matt Black

## OPTIONS

## LED

2700 K, 5000 K, 5700 K

## FINISHING

 Other Colours

## MIRO 90 TRACK

## MATT WHITE HOUSING AND MATT BLACK FRONT RING

Beam Angle (°)	Output (lm)	System (W)	ON/OFF	DALI
<b>3000 K</b>				
19°	1988	14	33.06.60.000247	33.06.60.000283
	2858	22	33.06.60.000250	33.06.60.000286
33°	1982	14	33.06.60.000248	33.06.60.000284
	2850	22	33.06.60.000251	33.06.60.000287
56°	1969	14	33.06.60.000249	33.06.60.000285
	2831	22	33.06.60.000252	33.06.60.000288
<b>4000 K</b>				
19°	2029	14	33.06.60.000319	33.06.60.000355
	2918	22	33.06.60.000322	33.06.60.000358
33°	2049	14	33.06.60.000320	33.06.60.000356
	2947	22	33.06.60.000323	33.06.60.000359
56°	1950	14	33.06.60.000321	33.06.60.000357
	2805	22	33.06.60.000324	33.06.60.000360

CRI &gt;80

Beam Angle (°)	Output (lm)	System (W)	ON/OFF	DALI
<b>3000 K</b>				
19°	1637	14	33.06.60.000265	33.06.60.000301
	2353	22	33.06.60.000268	33.06.60.000304
33°	1633	14	33.06.60.000266	33.06.60.000302
	2347	22	33.06.60.000269	33.06.60.000305
56°	1622	14	33.06.60.000267	33.06.60.000303
	2331	22	33.06.60.000270	33.06.60.000306
<b>4000 K</b>				
19°	1746	14	33.06.60.000337	33.06.60.000373
	2522	22	33.06.60.000340	33.06.60.000376
33°	1764	14	33.06.60.000338	33.06.60.000374
	2547	22	33.06.60.000341	33.06.60.000377
56°	1679	14	33.06.60.000339	33.06.60.000375
	2425	22	33.06.60.000342	33.06.60.000378

CRI &gt;90

> Ready to use - driver and 3-phase track universal adapter included.



## DESCRIPTION

1 > MATT WHITE HOUSING

2 > MATT BLACK FRONT RING

# MIRO 100 TRACK



## PT

- > Projetor orientável em dois eixos para aplicação em calha trifásica.
- > Orientável em 355° de rotação e 90° de inclinação.
- > Versões CRI >80 ou CRI >90 com elevada restituição cromática.
- > Três opções de ângulo de abertura do feixe: 27°, 44° ou 60°.
- > Acessórios óticos: Filtro controlo encandeamento, lente elíptica e filtro em vidro.
- > Com adaptador universal para instalação sem ferramentas numa variedade de calhas trifásicas.
- > Refletor em Policarbonato aluminizado brilhante.
- > Corpo em alumínio com acabamento texturado.

## ES

- > Proyector orientable en dos ejes para aplicación en carril trifásico.
- > Orientable con rotación de 355° y basculación de 90°.
- > Versiones CRI >80 o CRI >90 para muy buena reproducción del color.
- > Tres opciones de ángulo de emisión: 27°, 44° o 60°.
- > Accesorios ópticos: Filtro control del deslumbramiento, lente elíptica y filtro de cristal.
- > Con adaptador universal para instalación sin herramientas en diferentes carriles trifásicos.
- > Reflector en Policarbonato aluminizado de alto brillo.
- > Cuerpo en aluminio con acabado texturado.

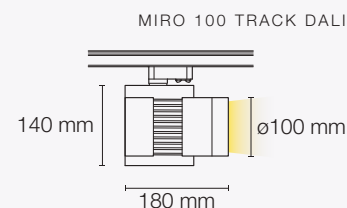
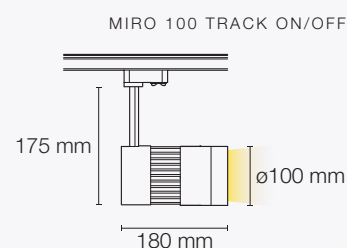

**QUICK INFO**

**GENERAL**

Track  
 IP20  
 650°C  
 Class I  
 Ta= -20°C +35°C

**OPTIC**

Aluminised Polycarbonate Reflector

**LED**

Efficacy up to 152 lm/W  
 3000 K, 4000 K  
 CRI >80, CRI >90  
 Lifetime 50 000 H  
 L80/B10 @TC=65°C

**ELETRICAL SYSTEM**

230V/50Hz  
 ON/OFF, DALI

**FINISHING**

RAL 9003 Matt White

**OPTIONS**

**LED**

2700 K, 5000 K, 5700 K

**FINISHING**

 Other Colours

**MIRO 100 TRACK**

**MATT WHITE FINISHING**

CRI >80

Beam Angle (°)	Output (lm)	System (W)	ON/OFF	DALI
<b>3000 K</b>				
27°	2548	21	33.06.60.000379	33.06.60.000403
	3226	27	33.06.60.000382	33.06.60.000406
44°	2547	21	33.06.60.000380	33.06.60.000404
	3322	27	33.06.60.000383	33.06.60.000407
60°	2540	21	33.06.60.000381	33.06.60.000405
	3314	27	33.06.60.000384	33.06.60.000408
<b>4000 K</b>				
27°	2625	21	33.06.60.000427	33.06.60.000451
	3324	27	33.06.60.000430	33.06.60.000454
44°	2624	21	33.06.60.000428	33.06.60.000452
	3322	27	33.06.60.000431	33.06.60.000455
60°	2618	21	33.06.60.000429	33.06.60.000453
	3314	27	33.06.60.000432	33.06.60.000456

CRI >90

Beam Angle (°)	Output (lm)	System (W)	ON/OFF	DALI
<b>3000 K</b>				
27°	2096	21	33.06.60.000391	33.06.60.000415
	2653	27	33.06.60.000394	33.06.60.000418
44°	2094	21	33.06.60.000392	33.06.60.000416
	2651	27	33.06.60.000395	33.06.60.000419
60°	2089	21	33.06.60.000393	33.06.60.000417
	2645	27	33.06.60.000396	33.06.60.000420
<b>4000 K</b>				
27°	2248	21	33.06.60.000439	33.06.60.000463
	2843	27	33.06.60.000442	33.06.60.000466
44°	2246	21	33.06.60.000440	33.06.60.000464
	2845	27	33.06.60.000443	33.06.60.000467
60°	2240	21	33.06.60.000441	33.06.60.000465
	2836	27	33.06.60.000444	33.06.60.000468

> Ready to use - driver and 3-phase track universal adapter included.



**ROTATION**

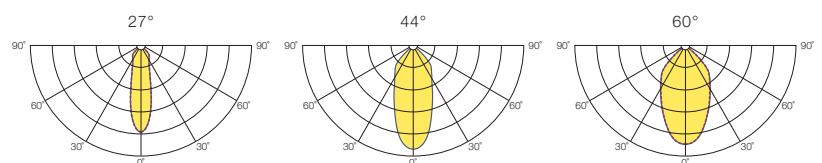
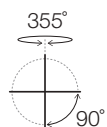

**QUICK INFO**

**GENERAL**

Track  
IP20  
650°C  
Class I  
Ta= -20°C +35°C

**OPTIC**

Aluminised Polycarbonate Reflector

**LED**

Efficacy up to 152 lm/W  
3000 K, 4000 K  
CRI >80, CRI >90  
Lifetime 50 000 H  
L80/B10 @TC=65°C

**ELETRICAL SYSTEM**

230V/50Hz  
ON/OFF, DALI

**FINISHING**

RAL 9005 Matt Black

**MIRO 100 TRACK**

**MATT BLACK FINISHING**

CRI>80

Beam Angle (°)	Output (lm)	System (W)	ON/OFF	DALI
<b>3000 K</b>				
27°	2548	21	33.06.60.000385	33.06.60.000409
	3226	27	33.06.60.000388	33.06.60.000412
44°	2547	21	33.06.60.000386	33.06.60.000410
	3322	27	33.06.60.000389	33.06.60.000413
60°	2540	21	33.06.60.000387	33.06.60.000411
	3314	27	33.06.60.000390	33.06.60.000414
<b>4000 K</b>				
27°	2625	21	33.06.60.000433	33.06.60.000457
	3324	27	33.06.60.000436	33.06.60.000460
44°	2624	21	33.06.60.000434	33.06.60.000458
	3322	27	33.06.60.000437	33.06.60.000461
60°	2618	21	33.06.60.000435	33.06.60.000459
	3314	27	33.06.60.000438	33.06.60.000462

**OPTIONS**

**LED**

2700 K, 5000 K, 5700 K

**FINISHING**

Other Colours

CRI>90

Beam Angle (°)	Output (lm)	System (W)	ON/OFF	DALI
<b>3000 K</b>				
27°	2096	21	33.06.60.000397	33.06.60.000421
	2653	27	33.06.60.000400	33.06.60.000424
44°	2094	21	33.06.60.000398	33.06.60.000422
	2651	27	33.06.60.000401	33.06.60.000425
60°	2089	21	33.06.60.000399	33.06.60.000423
	2645	27	33.06.60.000402	33.06.60.000426
<b>4000 K</b>				
27°	2248	21	33.06.60.000445	33.06.60.000469
	2843	27	33.06.60.000448	33.06.60.000472
44°	2246	21	33.06.60.000446	33.06.60.000470
	2845	27	33.06.60.000449	33.06.60.000473
60°	2240	21	33.06.60.000447	33.06.60.000471
	2836	27	33.06.60.000450	33.06.60.000474

> Ready to use - driver and 3-phase track universal adapter included.

**REFLECTORS**



# MIRO 100

## TRACK

### OPTIONS



#### HONEYCOMB LOUVRE

TYPE	DIMENSION	COD
Glare Control Filter	Ø85 mm	35.06.60.000634



#### ELLIPTICAL PROJECTION

TYPE	DIMENSION	COD
Elliptical Projection Glass	Ø85 mm	35.06.60.000635



#### GLASS FILTER

TYPE	DIMENSION	COD
Clear Glass Filter	Ø85 mm	35.06.60.000636



#### ON/OFF

INTEGRATED DRIVER  
COMPACT DESIGN,  
WITHOUT BOX



#### DALI

INTEGRATED DRIVER  
BOX DIMENSIONS  
140x120x40 mm



> MIRO 100 TRACK

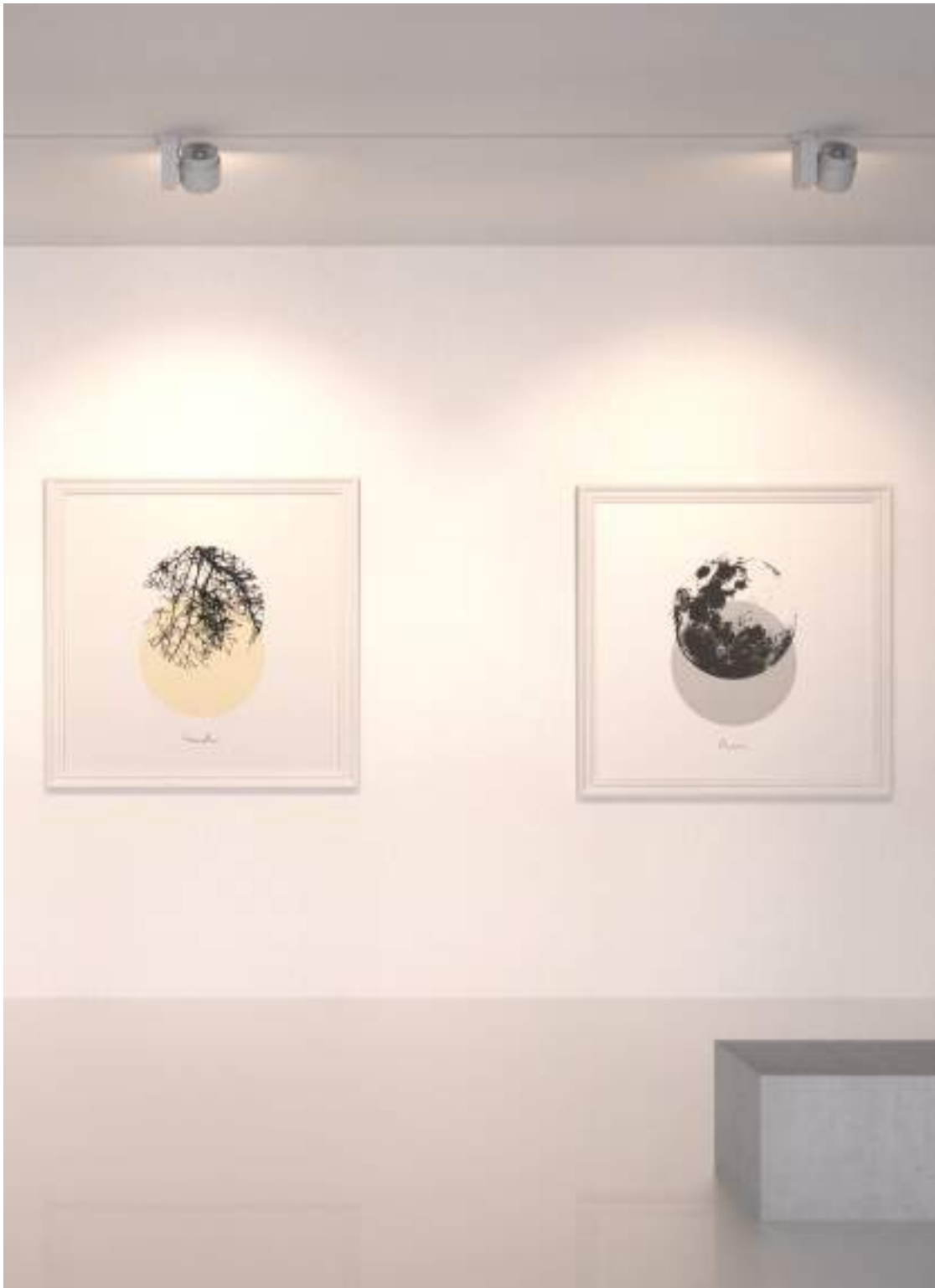

> **MIRO 130** TRACK

# MIRO 130

## TRACK



### PT

- > Projetor orientável em dois eixos para aplicação em calha trifásica.
- > Orientável em 355° de rotação e 90° de inclinação.
- > Versões CRI >80 ou CRI >90 com elevada restituição cromática.
- > Três opções de ângulo de abertura do feixe: 19°, 33° ou 56°.
- > Com adaptador universal para instalação sem ferramentas numa variedade de calhas trifásicas.
- > Refletor em alumínio Miro-Silver® de elevada eficiência.
- > Corpo em alumínio com acabamento texturado.

### ES

- > Proyector orientable en dos ejes para aplicación en carril trifásico.
- > Orientable con rotación de 355° y basculación de 90°.
- > Versiones CRI >80 o CRI >90 para muy buena reproducción del color.
- > Tres opciones de ángulo de emisión: 19°, 33° o 56°.
- > Con adaptador universal para instalación sin herramientas en diferentes carriles trifásicos.
- > Reflector en aluminio Miro-Silver® de alta eficiencia.
- > Cuerpo en aluminio con acabado texturado.

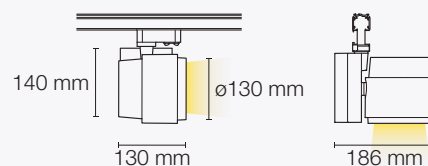



**QUICK INFO**

**GENERAL**

Track  
 IP20  
 650°C  
 Class I  
 Ta= -20°C +35°C

**OPTIC**

Aluminium Reflector

**LED**

Efficacy up to 173 lm/W  
 3000 K, 4000 K  
 CRI >80, CRI>90  
 Lifetime 50 000 H  
 L80/B10 @TC=65°C

**ELETRICAL SYSTEM**

230V/50Hz  
 ON/OFF, DALI

**FINISHING**

RAL 9003 Matt White

**MIRO 130 TRACK**

**MATT WHITE FINISHING**

CRI>80

Beam Angle (°)	Output (lm)	System (W)	ON/OFF	DALI
<b>3000 K</b>				
19°	3453	26	33.06.60.000475	33.06.60.000511
	3889	30	33.06.60.000478	33.06.60.000514
33°	3443	26	33.06.60.000476	33.06.60.000512
	3878	30	33.06.60.000479	33.06.60.000515
56°	3420	26	33.06.60.000477	33.06.60.000513
	3852	30	33.06.60.000480	33.06.60.000516
<b>4000 K</b>				
19°	3643	26	33.06.60.000643	33.06.60.000679
	4102	30	33.06.60.000646	33.06.60.000682
33°	3633	26	33.06.60.000644	33.06.60.000680
	4090	30	33.06.60.000647	33.06.60.000683
56°	3609	26	33.06.60.000645	33.06.60.000681
	4063	30	33.06.60.000648	33.06.60.000684

**OPTIONS**

**LED**

2700 K, 5000 K, 5700 K

**FINISHING**

Other Colours

CRI>90

Beam Angle (°)	Output (lm)	System (W)	ON/OFF	DALI
<b>3000 K</b>				
19°	2908	26	33.06.60.000493	33.06.60.000529
	3275	30	33.06.60.000496	33.06.60.000532
33°	2900	26	33.06.60.000494	33.06.60.000530
	3266	30	33.06.60.000497	33.06.60.000533
56°	2881	26	33.06.60.000495	33.06.60.000531
	3244	30	33.06.60.000498	33.06.60.000534
<b>4000 K</b>				
19°	3118	26	33.06.60.000661	33.06.60.000697
	3517	30	33.06.60.000664	33.06.60.000700
33°	3109	26	33.06.60.000662	33.06.60.000698
	3508	30	33.06.60.000665	33.06.60.000701
56°	3089	26	33.06.60.000663	33.06.60.000699
	3484	30	33.06.60.000666	33.06.60.000702

> Ready to use - driver and 3-phase track universal adapter included.



**ROTATION**

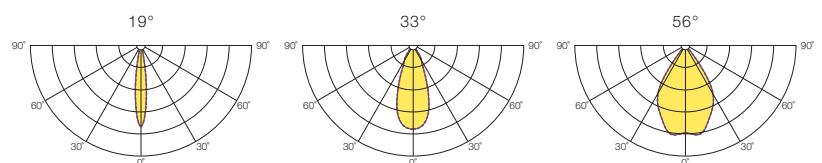
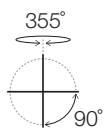

**QUICK INFO**

**GENERAL**

Track  
 IP20  
 650°C  
 Class I  
 Ta= -20°C +35°C

**OPTIC**

Aluminium Reflector

**LED**

Efficacy up to 173 lm/W  
 3000 K, 4000 K  
 CRI >80, CRI>90  
 Lifetime 50 000 H  
 L80/B10 @TC=65°C

**ELETRICAL SYSTEM**

230V/50Hz  
 ON/OFF, DALI

**FINISHING**

RAL 9005 Matt Black

CRI>80

**MIRO 130 TRACK**

**MATT BLACK FINISHING**

Beam Angle (°)	Output (lm)	System (W)	ON/OFF	DALI
<b>3000 K</b>				
19°	3453	26	33.06.60.000481	33.06.60.000517
	3889	30	33.06.60.000484	33.06.60.000520
33°	3443	26	33.06.60.000482	33.06.60.000518
	3878	30	33.06.60.000485	33.06.60.000521
56°	3420	26	33.06.60.000483	33.06.60.000519
	3852	30	33.06.60.000486	33.06.60.000522
<b>4000 K</b>				
19°	3643	26	33.06.60.000649	33.06.60.000685
	4102	30	33.06.60.000652	33.06.60.000688
33°	3633	26	33.06.60.000650	33.06.60.000686
	4090	30	33.06.60.000653	33.06.60.000689
56°	3609	26	33.06.60.000651	33.06.60.000687
	4063	30	33.06.60.000654	33.06.60.000690

**OPTIONS**

**LED**

2700 K, 5000 K, 5700 K

**FINISHING**

Other Colours

CRI>90

Beam Angle (°)	Output (lm)	System (W)	ON/OFF	DALI
<b>3000 K</b>				
19°	2908	26	33.06.60.000499	33.06.60.000535
	3275	30	33.06.60.000502	33.06.60.000538
33°	2900	26	33.06.60.000500	33.06.60.000536
	3266	30	33.06.60.000503	33.06.60.000539
56°	2881	26	33.06.60.000501	33.06.60.000537
	3244	30	33.06.60.000504	33.06.60.000540
<b>4000 K</b>				
19°	3118	26	33.06.60.000667	33.06.60.000703
	3517	30	33.06.60.000670	33.06.60.000706
33°	3109	26	33.06.60.000668	33.06.60.000704
	3508	30	33.06.60.000671	33.06.60.000707
56°	3089	26	33.06.60.000669	33.06.60.000705
	3484	30	33.06.60.000672	33.06.60.000708

> Ready to use - driver and 3-phase track universal adapter included.



**REFLECTORS**



## QUICK INFO

## GENERAL

Track  
IP20  
650°C  
Class I  
Ta= -20°C +35°C

## OPTIC

Aluminium Reflector

## LED

Efficacy up to 173 lm/W  
3000 K, 4000 K  
CRI >80, CRI>90  
Lifetime 50 000 H  
L80/B10 @TC=65°C

## ELETRICAL SYSTEM

230V/50Hz  
ON/OFF, DALI

## FINISHING

RAL 9003 Matt White  
RAL 9005 Matt Black

## OPTIONS

## LED

2700 K, 5000 K, 5700 K

## FINISHING

 Other Colours

## MIRO 130 TRACK

## MATT WHITE HOUSING AND MATT BLACK FRONT RING

Beam Angle (°)	Output (lm)	System (W)	ON/OFF	DALI
<b>3000 K</b>				
19°	3453	26	33.06.60.000487	33.06.60.000523
	3889	30	33.06.60.000490	33.06.60.000526
33°	3443	26	33.06.60.000488	33.06.60.000524
	3878	30	33.06.60.000491	33.06.60.000527
56°	3420	26	33.06.60.000489	33.06.60.000525
	3852	30	33.06.60.000492	33.06.60.000528
<b>4000 K</b>				
19°	3643	26	33.06.60.000655	33.06.60.000691
	4102	30	33.06.60.000658	33.06.60.000694
33°	3633	26	33.06.60.000656	33.06.60.000692
	4090	30	33.06.60.000659	33.06.60.000695
56°	3609	26	33.06.60.000657	33.06.60.000693
	4063	30	33.06.60.000660	33.06.60.000696

CRI&gt;80

Beam Angle (°)	Output (lm)	System (W)	ON/OFF	DALI
<b>3000 K</b>				
19°	2908	26	33.06.60.000505	33.06.60.000541
	3275	30	33.06.60.000508	33.06.60.000544
33°	2900	26	33.06.60.000506	33.06.60.000542
	3266	30	33.06.60.000509	33.06.60.000545
56°	2881	26	33.06.60.000507	33.06.60.000543
	3244	30	33.06.60.000510	33.06.60.000546
<b>4000 K</b>				
19°	3118	26	33.06.60.000673	33.06.60.000709
	3517	30	33.06.60.000676	33.06.60.000712
33°	3109	26	33.06.60.000674	33.06.60.000710
	3508	30	33.06.60.000677	33.06.60.000713
56°	3089	26	33.06.60.000675	33.06.60.000711
	3484	30	33.06.60.000678	33.06.60.000714

CRI&gt;90

> Ready to use - driver and 3-phase track universal adapter included.

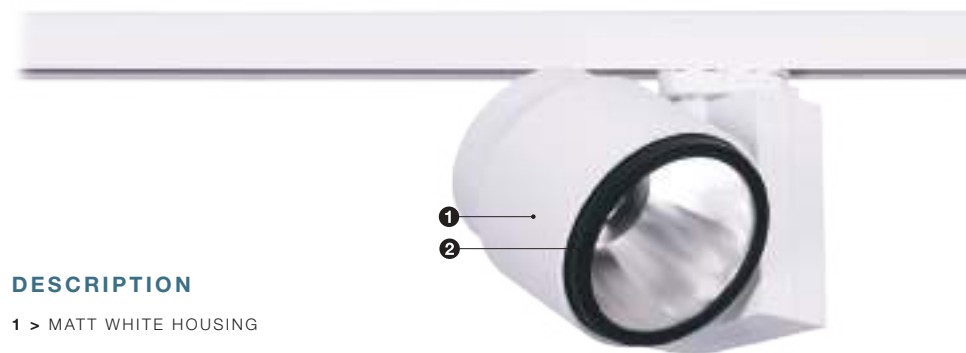

## DESCRIPTION

1 > MATT WHITE HOUSING

2 > MATT BLACK FRONT RING

# MIRO 140

## TRACK



### PT

- > Projetor orientável em dois eixos para aplicação em calha trifásica.
- > Orientável em 355° de rotação e 90° de inclinação.
- > Versões CRI >80 ou CRI >90 com elevada restituição cromática.
- > Três opções de ângulo de abertura do feixe: 19°, 32° ou 46°.
- > Acessórios óticos: Filtro controlo encandeamento, lente elíptica e filtro em vidro.
- > Com adaptador universal para instalação sem ferramentas numa variedade de calhas trifásicas.
- > Refletor em Policarbonato aluminizado brilhante.
- > Corpo em alumínio com acabamento texturado.

### ES

- > Proyector orientable en dos ejes para aplicación en carril trifásico.
- > Orientable con rotación de 355° y basculación de 90°.
- > Versiones CRI >80 o CRI >90 para muy buena reproducción del color.
- > Tres opciones de ángulo de emisión: 19°, 32° o 46°.
- > Accesorios ópticos: Filtro control del deslumbramiento, lente elíptica y filtro de cristal.
- > Con adaptador universal para instalación sin herramientas en diferentes carriles trifásicos.
- > Reflector en Policarbonato aluminizado de alto brillo.
- > Cuerpo en aluminio con acabado texturado.

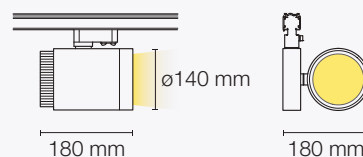

**QUICK INFO**

**GENERAL**

Track  
 IP20  
 650°C  
 Class I  
 Ta= -20°C +35°C

**OPTIC**

Aluminised Polycarbonate Reflector

**LED**

Efficacy up to 149 lm/W  
 3000 K, 4000 K  
 CRI >80, CRI >90  
 Lifetime 50 000 H  
 L80/B10 @TC=65°C

**ELETRICAL SYSTEM**

230V/50Hz  
 ON/OFF, DALI

**FINISHING**

RAL 9003 Matt White

**MIRO 140 TRACK**

**MATT WHITE FINISHING**

CRI >80

Beam Angle (°)	Output (lm)	System (W)	ON/OFF	DALI
<b>3000 K</b>				
19°	3753	38	33.06.60.000547	33.06.60.000571
	4586	49	33.06.60.000550	33.06.60.000574
32°	3437	38	33.06.60.000548	33.06.60.000572
	4200	49	33.06.60.000551	33.06.60.000575
46°	3292	38	33.06.60.000549	33.06.60.000573
	4024	49	33.06.60.000552	33.06.60.000576
<b>4000 K</b>				
19°	3789	38	33.06.60.000595	33.06.60.000619
	4631	49	33.06.60.000598	33.06.60.000622
32°	3470	38	33.06.60.000596	33.06.60.000620
	4242	49	33.06.60.000599	33.06.60.000623
46°	3324	38	33.06.60.000597	33.06.60.000621
	4063	49	33.06.60.000600	33.06.60.000624

**OPTIONS**

**LED**

2700 K, 5000 K

**FINISHING**

Other Colours

CRI >90

Beam Angle (°)	Output (lm)	System (W)	ON/OFF	DALI
<b>3000 K</b>				
19°	3024	38	33.06.60.000559	33.06.60.000583
	3696	49	33.06.60.000562	33.06.60.000586
32°	2770	38	33.06.60.000560	33.06.60.000584
	3385	49	33.06.60.000563	33.06.60.000587
46°	2653	38	33.06.60.000561	33.06.60.000585
	3242	49	33.06.60.000564	33.06.60.000588
<b>4000 K</b>				
19°	3242	38	33.06.60.000607	33.06.60.000631
	3963	49	33.06.60.000610	33.06.60.000634
32°	2970	38	33.06.60.000608	33.06.60.000632
	3630	49	33.06.60.000611	33.06.60.000635
46°	2844	38	33.06.60.000609	33.06.60.000633
	3477	49	33.06.60.000612	33.06.60.000636

> Ready to use - driver and 3-phase track universal adapter included.



**ROTATION**

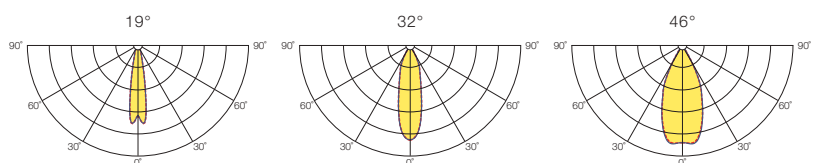
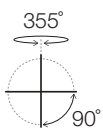

**QUICK INFO**

**GENERAL**

Track  
 IP20  
 650°C  
 Class I  
 Ta= -20°C +35°C

**OPTIC**

Aluminised Polycarbonate Reflector

**LED**

Efficacy up to 149 lm/W  
 3000 K, 4000 K  
 CRI >80, CRI >90  
 Lifetime 50 000 H  
 L80/B10 @TC=65°C

**ELETRICAL SYSTEM**

230V/50Hz  
 ON/OFF, DALI

**FINISHING**

RAL 9005 Matt Black

**MIRO 140 TRACK**

**MATT BLACK FINISHING**

CRI >80

Beam Angle (°)	Output (lm)	System (W)	ON/OFF	DALI
<b>3000 K</b>				
19°	3753	38	33.06.60.000553	33.06.60.000577
	4586	49	33.06.60.000556	33.06.60.000580
32°	3437	38	33.06.60.000554	33.06.60.000578
	4200	49	33.06.60.000557	33.06.60.000581
46°	3292	38	33.06.60.000555	33.06.60.000579
	4024	49	33.06.60.000558	33.06.60.000582
<b>4000 K</b>				
19°	3789	38	33.06.60.000601	33.06.60.000625
	4631	49	33.06.60.000604	33.06.60.000628
32°	3470	38	33.06.60.000602	33.06.60.000626
	4242	49	33.06.60.000605	33.06.60.000629
46°	3324	38	33.06.60.000603	33.06.60.000627
	4063	49	33.06.60.000606	33.06.60.000630

**OPTIONS**

**LED**

2700 K, 5000 K

**FINISHING**

Other Colours

CRI >90

Beam Angle (°)	Output (lm)	System (W)	ON/OFF	DALI
<b>3000 K</b>				
19°	3024	38	33.06.60.000565	33.06.60.000589
	3696	49	33.06.60.000568	33.06.60.000592
32°	2770	38	33.06.60.000566	33.06.60.000590
	3385	49	33.06.60.000569	33.06.60.000593
46°	2653	38	33.06.60.000567	33.06.60.000591
	3242	49	33.06.60.000570	33.06.60.000594
<b>4000 K</b>				
19°	3242	38	33.06.60.000613	33.06.60.000637
	3963	49	33.06.60.000616	33.06.60.000640
32°	2970	38	33.06.60.000614	33.06.60.000638
	3630	49	33.06.60.000617	33.06.60.000641
46°	2844	38	33.06.60.000615	33.06.60.000639
	3477	49	33.06.60.000618	33.06.60.000642

> Ready to use - driver and 3-phase track universal adapter included.

**REFLECTORS**



# MIRO 140

## TRACK

### OPTIONS



#### HONEYCOMB LOUVRE

TYPE	DIMENSION	COD
Glare Control Filter	Ø119 mm	35.06.60.000637



#### ELLIPTICAL PROJECTION

TYPE	DIMENSION	COD
Elliptical Projection Glass	Ø119 mm	35.06.60.000638



#### GLASS FILTER

TYPE	DIMENSION	COD
Clear Glass Filter	Ø119 mm	35.06.60.000639







# RETAIL OVERVIEW

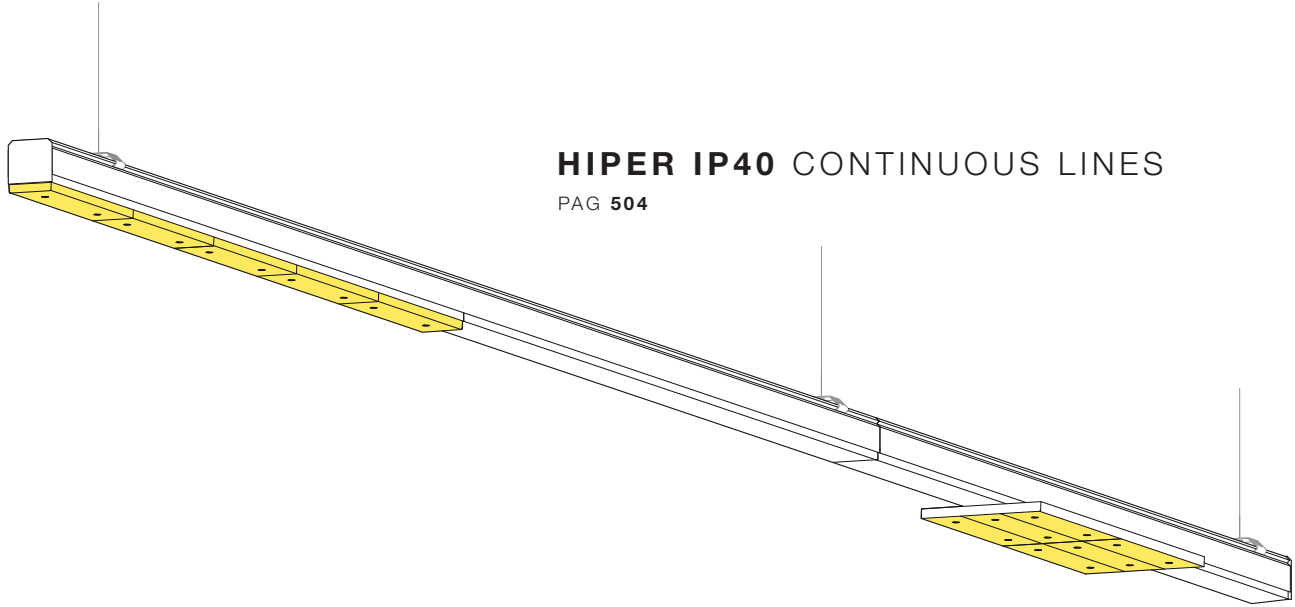

## HIPER IP40 CONTINUOUS LINES

PAG 504

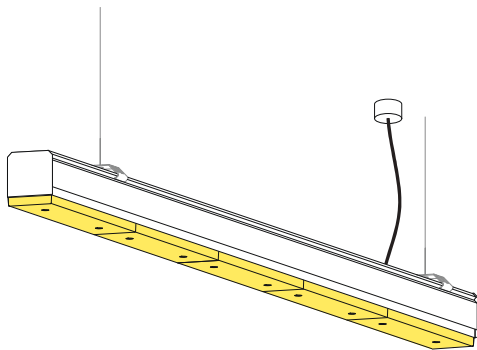

## HIPER IP40 INDIVIDUAL

PAG 540

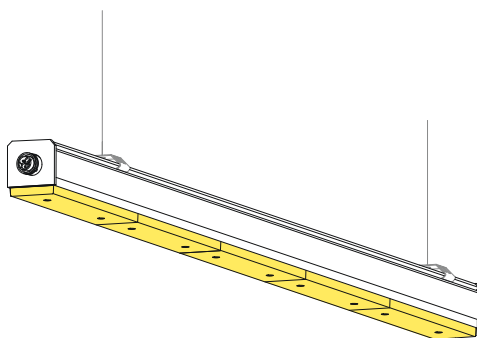

## HIPER IP54 INDIVIDUAL

PAG 548

# HIPER IP40 CONTINUOUS LINES

## OVERVIEW

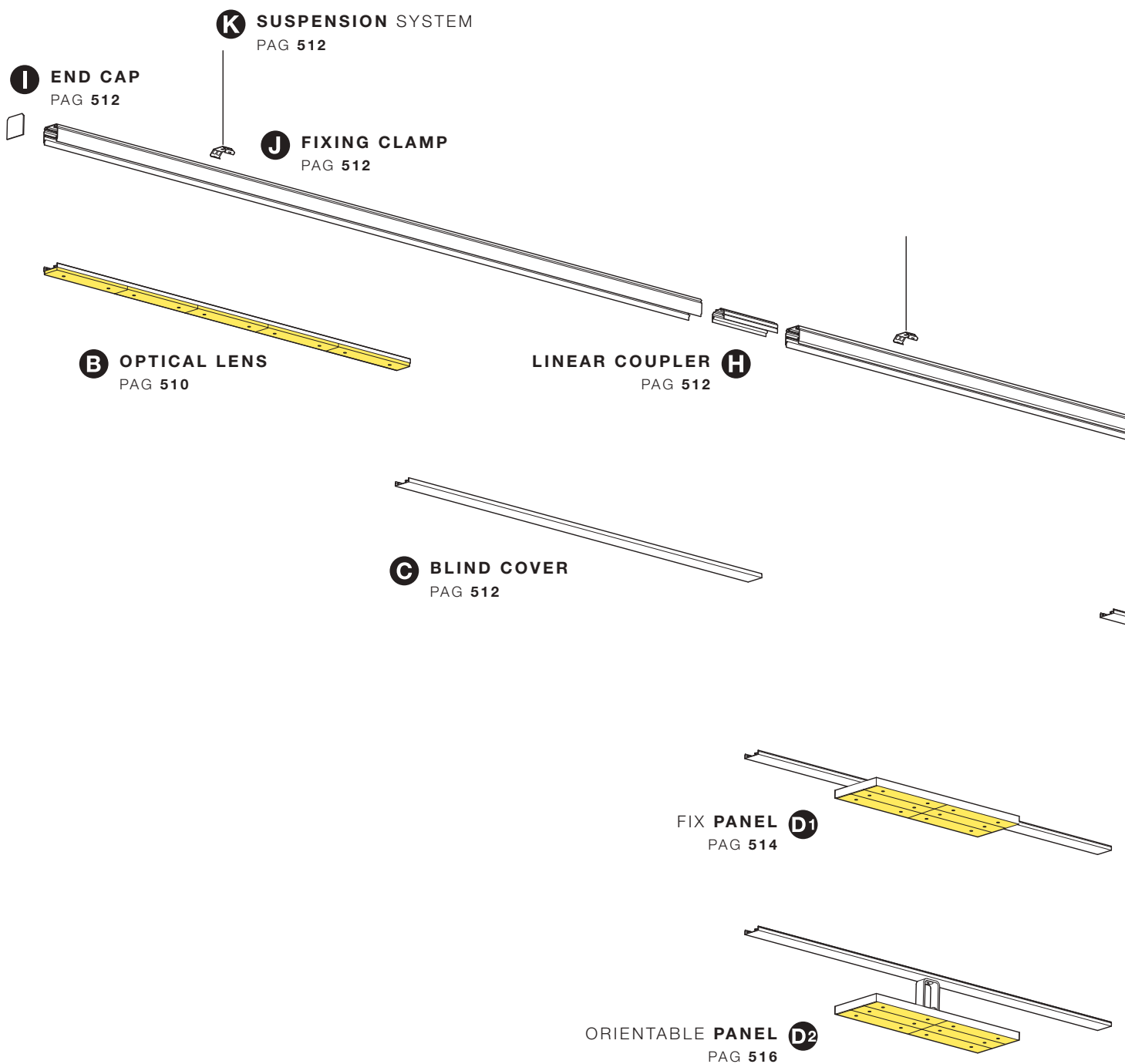

**A** TRUNKING RAIL  
PAG 508

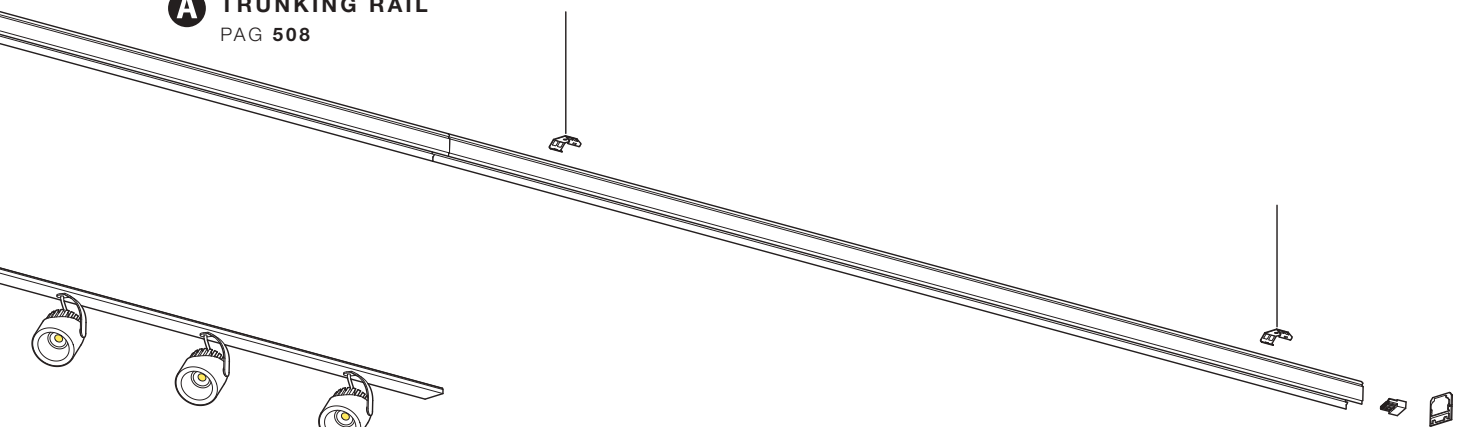

**RAPID FEED-INS** **L**  
PAG 512

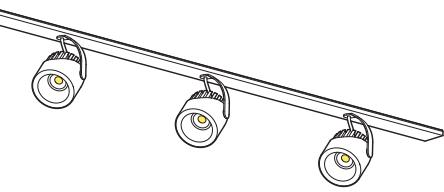

**E** TRACK SPOTS  
PAG 518

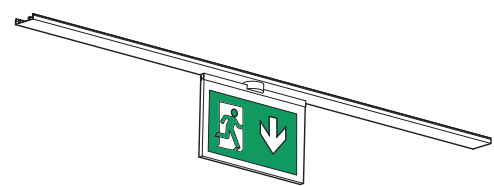

**G** EME  
PAG 538

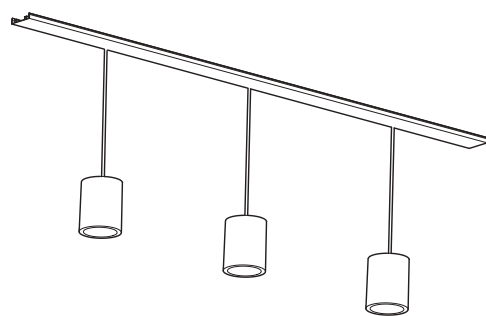

**F** SUSPENDED SPOTS  
PAG 528

**HIPER IP40** CONTINUOUS LINES  
SUSPENDED





# HIPER IP40 CONTINUOUS LINES SUSPENDED



## PT

- > Sistema de iluminação modular para montagem rápida de linhas contínuas.
- > Emissão de luz contínua e uniforme em todo o comprimento da linha.
- > Óticas com ângulo de abertura 60° (UGR <19), 90° ou 110°, bem como óticas com distribuição assimétrica e dupla assimétrica.
- > Diversos módulos disponíveis para otimizar o sistema ao espaço de aplicação: painéis, projetores e luminárias com indicação de saída de emergência.
- > Sistema de clipagem permite instalação rápida com apenas um clique e sem recurso a ferramentas.
- > Corpo em perfil de alumínio extrudido com revestimento em poliéster.

## ES

- > Sistema de iluminación modular para montaje rápido de líneas continuas.
- > Emisión de luz sin interrupciones y uniforme en toda la longitud de la línea.
- > Ópticas con ángulo de emisión 60° (UGR <19), 90° o 110°, así como ópticas con distribución asimétrica y doble asimétrica.
- > Diversos módulos están disponibles para optimizar el sistema al espacio de aplicación: paneles, proyectores y luminarias con indicación de salida de emergencia.
- > Sistema de clipaje permite una instalación rápida con un simple clic y sin herramientas.
- > Cuerpo en perfil de aluminio extruido con recubrimiento de poliéster.

SUSPENDED

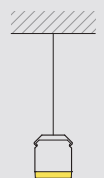

SURFACE

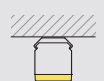

**QUICK INFO**

**GENERAL**

Suspended / Surface  
 IP40 (Optic)  
 IP20  
 IK07  
 650°C  
 Class I  
 Ta= -20°C +40°C

**OPTIC**

PMMA Lens  
 UGR <19 (Lens 60°)

**LED**

Efficacy up to 182 lm/W  
 3000 K, 4000 K  
 CRI >80  
 Lifetime 54 000 H  
 L80/B10 @Tc=75°C

**ELETRICAL SYSTEM**

230V/50Hz  
 ON/OFF, DALI

**FINISHING**

RAL 9003 Matt White  
 RAL 9005 Matt Black

**OPTIONS**

**LED**

5000 K, 6500 K  
 CRI >90

**ELECTRICAL SYSTEM**

DSI, DIM 1-10V

**CONTROL SYSTEM**

Bluetooth

**FINISHING**

 Other Colours

**SENSORS**

Motion  
 Ambient Light  
 Motion & Ambient Light



**A TRUNKING RAIL**

c (mm)	MATT WHITE	MATT BLACK
<b>CONTINUOUS LINE</b>		
	<b>7G2,5</b>	<b>7G2,5</b>
1435	35.83.001.08.00	35.83.001.08.63
2007	35.83.001.08.01	35.83.001.08.64
2871	35.83.001.08.02	35.83.001.08.65
4017	35.83.001.08.03	35.83.001.08.66
<b>CONTINUOUS LINE + EMERGENCY</b>		
	<b>11G2,5</b>	<b>11G2,5</b>
1435	35.83.001.08.04	35.83.001.08.67
2007	35.83.001.08.05	35.83.001.08.68
2871	35.83.001.08.06	35.83.001.08.69
4017	35.83.001.08.07	35.83.001.08.70

**OPTICAL LENS**

OPTIC TYPE		INDUSTRY	SHOP & RETAIL	EDUCATION	OFFICE
60° (UGR <19)		✓	✓	✓	✓
90°		✓	✓	✗	✗
110°		✓	✓	✗	✗
Asymmetric		✓	✓	✓	✓
Double Asymmetric		✓	✓	✓	✗

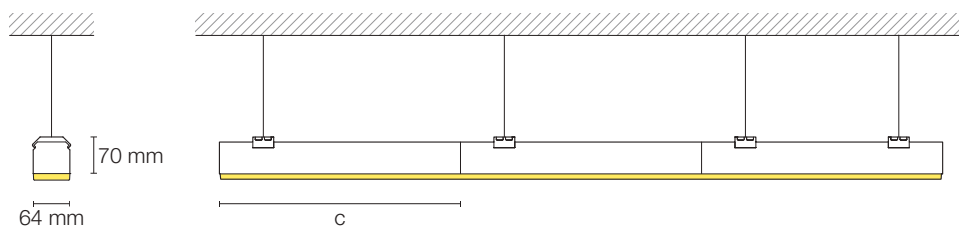
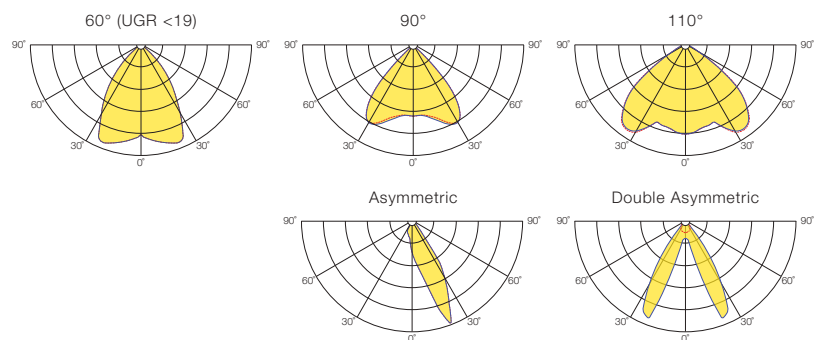

# HIPER IP40 OPTICAL LENS

**B**

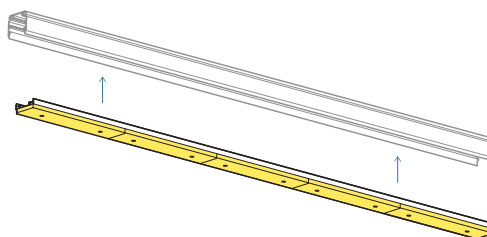





**3000 K**

c (mm)	Output (lm)	System (W)	MATT WHITE		MATT BLACK	
			ON/OFF	DALI	ON/OFF	DALI
<b>60°</b>						
1435	6435	42	35.83.011.08.04	35.83.011.08.29	35.83.011.08.59	35.83.011.08.84
	8780	61	35.83.011.08.05	35.83.011.08.30	35.83.011.08.60	35.83.011.08.85
	16462	129	35.83.011.08.06	35.83.011.08.31	35.83.011.08.61	35.83.011.08.86
	9010	59	35.83.011.08.07	35.83.011.08.32	35.83.011.08.62	35.83.011.08.87
	12292	85	35.83.011.08.08	35.83.011.08.33	35.83.011.08.63	35.83.011.08.88
2007	23048	181	35.83.014.08.24	35.83.011.08.34	35.83.014.08.29	35.83.011.08.89
<b>90°</b>						
1435	6196	42	35.83.011.08.09	35.83.011.08.35	35.83.011.08.64	35.83.011.08.90
	8453	61	35.83.011.08.10	35.83.011.08.36	35.83.011.08.65	35.83.011.08.91
	15850	129	35.83.011.08.11	35.83.011.08.37	35.83.011.08.66	35.83.011.08.92
	8674	59	35.83.011.08.12	35.83.011.08.38	35.83.011.08.67	35.83.011.08.93
	11834	85	35.83.011.08.13	35.83.011.08.39	35.83.011.08.68	35.83.011.08.94
2007	22189	181	35.83.014.08.25	35.83.011.08.40	35.83.014.08.30	35.83.011.08.95
<b>110°</b>						
1435	6300	42	35.83.011.08.14	35.83.011.08.41	35.83.011.08.69	35.83.011.08.96
	8595	61	35.83.011.08.15	35.83.011.08.42	35.83.011.08.70	35.83.011.08.97
	16115	129	35.83.011.08.16	35.83.011.08.43	35.83.011.08.71	35.83.011.08.98
	8819	59	35.83.011.08.17	35.83.011.08.44	35.83.011.08.72	35.83.011.08.99
	12033	85	35.83.011.08.18	35.83.011.08.45	35.83.011.08.73	35.83.012.08.00
2007	22561	181	35.83.014.08.26	35.83.011.08.46	35.83.014.08.31	35.83.012.08.01
<b>ASYMMETRIC</b>						
1435	6354	42	35.83.011.08.19	35.83.011.08.47	35.83.011.08.74	35.83.012.08.02
	8668	61	35.83.011.08.20	35.83.011.08.48	35.83.011.08.75	35.83.012.08.03
	16253	129	35.83.011.08.21	35.83.011.08.49	35.83.011.08.76	35.83.012.08.04
	8895	59	35.83.011.08.22	35.83.011.08.50	35.83.011.08.77	35.83.012.08.05
	12136	85	35.83.011.08.23	35.83.011.08.51	35.83.011.08.78	35.83.012.08.06
2007	22754	181	35.83.014.08.27	35.83.011.08.52	35.83.014.08.32	35.83.012.08.07
<b>DOUBLE ASYMMETRIC</b>						
1435	6333	42	35.83.011.08.24	35.83.011.08.53	35.83.011.08.79	35.83.012.08.08
	8640	61	35.83.011.08.25	35.83.011.08.54	35.83.011.08.80	35.83.012.08.09
	16200	129	35.83.011.08.26	35.83.011.08.55	35.83.011.08.81	35.83.012.08.10
	8866	59	35.83.011.08.27	35.83.011.08.56	35.83.011.08.82	35.83.012.08.11
	12096	85	35.83.011.08.28	35.83.011.08.57	35.83.011.08.83	35.83.012.08.12
2007	22680	181	35.83.014.08.28	35.83.011.08.58	35.83.014.08.33	35.83.012.08.13





**4000 K**

c (mm)	Output (lm)	System (W)	MATT WHITE		MATT BLACK		
			ON/OFF	DALI	ON/OFF	DALI	
<b>60°</b>							
	1435	6909	42	35.83.012.08.14	35.83.012.08.39	35.83.012.08.69	35.83.012.08.94
	1435	9428	61	35.83.012.08.15	35.83.012.08.40	35.83.012.08.70	35.83.012.08.95
		17660	129	35.83.012.08.16	35.83.012.08.41	35.83.012.08.71	35.83.012.08.96
		9673	59	35.83.012.08.17	35.83.012.08.42	35.83.012.08.72	35.83.012.08.97
	2007	13200	85	35.83.012.08.18	35.83.012.08.43	35.83.012.08.73	35.83.012.08.98
		24724	181	35.83.014.08.34	35.83.012.08.44	35.83.014.08.39	35.83.012.08.99
<b>90°</b>							
	1435	6652	42	35.83.012.08.19	35.83.012.08.45	35.83.012.08.74	35.83.013.08.00
	1435	9077	61	35.83.012.08.20	35.83.012.08.46	35.83.012.08.75	35.83.013.08.01
		17002	129	35.83.012.08.21	35.83.012.08.47	35.83.012.08.76	35.83.013.08.02
		9313	59	35.83.012.08.22	35.83.012.08.48	35.83.012.08.77	35.83.013.08.03
	2007	12708	85	35.83.012.08.23	35.83.012.08.49	35.83.012.08.78	35.83.013.08.04
		23803	181	35.83.014.08.35	35.83.012.08.50	35.83.014.08.40	35.83.013.08.05
<b>110°</b>							
	1435	6763	42	35.83.012.08.24	35.83.012.08.51	35.83.012.08.79	35.83.013.08.06
	1435	9230	61	35.83.012.08.25	35.83.012.08.52	35.83.012.08.80	35.83.013.08.07
		17287	129	35.83.012.08.26	35.83.012.08.53	35.83.012.08.81	35.83.013.08.08
		9469	59	35.83.012.08.27	35.83.012.08.54	35.83.012.08.82	35.83.013.08.09
	2007	12921	85	35.83.012.08.28	35.83.012.08.55	35.83.012.08.83	35.83.013.08.10
		24202	181	35.83.014.08.36	35.83.012.08.56	35.83.014.08.41	35.83.013.08.11
<b>ASYMMETRIC</b>							
	1435	6821	42	35.83.012.08.29	35.83.012.08.57	35.83.012.08.84	35.83.013.08.12
	1435	9309	61	35.83.012.08.30	35.83.012.08.58	35.83.012.08.85	35.83.013.08.13
		17435	129	35.83.012.08.31	35.83.012.08.59	35.83.012.08.86	35.83.013.08.14
		9550	59	35.83.012.08.32	35.83.012.08.60	35.83.012.08.87	35.83.013.08.15
	2007	13032	85	35.83.012.08.33	35.83.012.08.61	35.83.012.08.88	35.83.013.08.16
		24409	181	35.83.014.08.37	35.83.012.08.62	35.83.014.08.42	35.83.013.08.17
<b>DOUBLE ASYMMETRIC</b>							
	1435	6799	42	35.83.012.08.34	35.83.012.08.63	35.83.012.08.89	35.83.013.08.18
	1435	9278	61	35.83.012.08.35	35.83.012.08.64	35.83.012.08.90	35.83.013.08.19
		17378	129	35.83.012.08.36	35.83.012.08.65	35.83.012.08.91	35.83.013.08.20
		9519	59	35.83.012.08.37	35.83.012.08.66	35.83.012.08.92	35.83.013.08.21
	2007	12990	85	35.83.012.08.38	35.83.012.08.67	35.83.012.08.93	35.83.013.08.22
		24330	181	35.83.014.08.38	35.83.012.08.68	35.83.014.08.43	35.83.013.08.23

# HIPER IP40 CONTINUOUS LINE

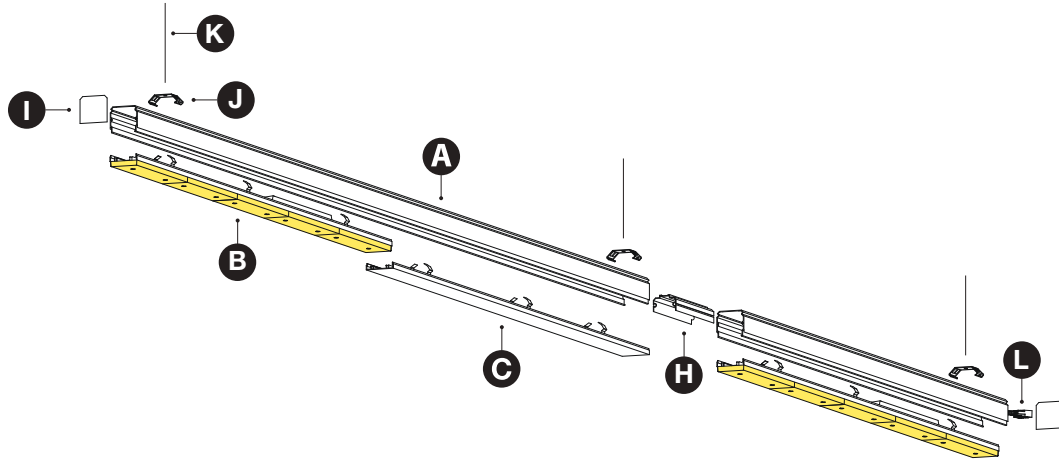

## COMPONENTS



### C BLIND COVER

c (mm)	MATT WHITE	MATT BLACK
1435	35.83.001.08.11	35.83.001.08.71
2007	35.83.001.08.12	35.83.001.08.72



### H LINEAR COUPLER

TYPE	COD
Linear Coupler	35.83.001.08.10



### I END CAP (1pc)

TYPE	MATT WHITE	MATT BLACK
End Cap	35.83.001.08.08	35.83.001.08.82



### J FIXING CLAMP (1pc)

TYPE	COD
Suspended/Surface Stainless Steel Clamp	35.83.000.08.48



### K SUSPENSION SYSTEM (1pc)

TYPE	FIG	3m	5m	10m
Stainless Steel Cable - Screw	1	61.01.83.000.00	61.01.83.000.01	61.01.83.000.02
Stainless Steel Cable - Tie	2	61.01.83.000.03	61.01.83.000.04	61.01.83.000.05



**GRIPPLE**® Certified Suspension



### L RAPID FEED-INS (1pc)

TYPE	7G2,5	11G2,5
Female Connector - Beginning of Line	35.83.001.08.80	35.83.001.08.81

**OPTIONS**



**EMERGENCY (EM) - SELF-TEST INTEGRATED**

<b>ON/OFF</b>	<b>COD</b>
EM 1H 4,4W	35.00.004.01.17
EM 3H 4,4W	35.00.004.01.18
<b>DALI</b>	<b>COD</b>
EM 1H 5,4W DALI	35.00.004.01.63
EM 3H 5,4W DALI	35.00.004.01.64

**INSTALLATION**

**SURFACE MOUNTING**

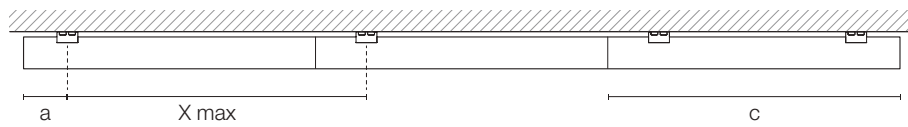

Recommended Spacing  
 a: 100 to 250 mm  
 X max = c

**SUSPENDED MOUNTING**

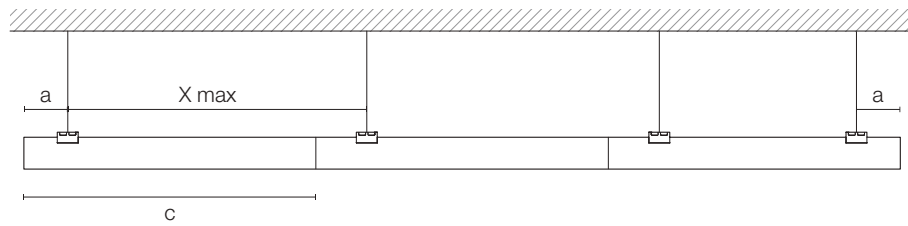



Recommended Spacing  
 a: 100 to 250 mm  
 X max = c

# HIPER IP40 FIX PANEL

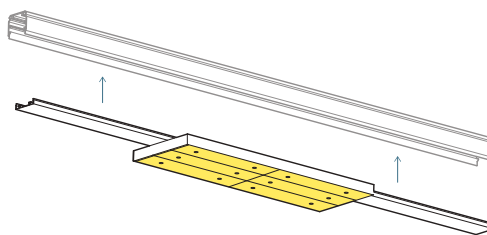

D1



## 4000 K

c (mm)	Output (lm)	System (W)	MATT WHITE		MATT BLACK		
			ON/OFF	DALI	ON/OFF	DALI	
<b>60°</b>							
	1435	6137	40	35.83.013.08.24	35.83.013.08.30	35.83.013.08.36	35.83.013.08.42
	2007	7566	51	35.83.013.08.25	35.83.013.08.31	35.83.013.08.37	35.83.013.08.43
<b>90°</b>							
	1435	5966	40	35.83.013.08.26	35.83.013.08.32	35.83.013.08.38	35.83.013.08.44
	2007	7345	51	35.83.013.08.27	35.83.013.08.33	35.83.013.08.39	35.83.013.08.45
<b>110°</b>							
	1435	6085	40	35.83.013.08.28	35.83.013.08.34	35.83.013.08.40	35.83.013.08.46
	2007	7492	51	35.83.013.08.29	35.83.013.08.35	35.83.013.08.41	35.83.013.08.47

## 5000 K

c (mm)	Output (lm)	System (W)	MATT WHITE		MATT BLACK		
			ON/OFF	DALI	ON/OFF	DALI	
<b>60°</b>							
	1435	6219	40	35.83.013.08.48	35.83.013.08.54	35.83.013.08.60	35.83.013.08.66
	2007	7665	51	35.83.013.08.49	35.83.013.08.55	35.83.013.08.61	35.83.013.08.67
<b>90°</b>							
	1435	6045	40	35.83.013.08.50	35.83.013.08.56	35.83.013.08.62	35.83.013.08.68
	2007	7451	51	35.83.013.08.51	35.83.013.08.57	35.83.013.08.63	35.83.013.08.69
<b>110°</b>							
	1435	6166	40	35.83.013.08.52	35.83.013.08.58	35.83.013.08.64	35.83.013.08.70
	2007	7600	51	35.83.013.08.53	35.83.013.08.59	35.83.013.08.65	35.83.013.08.71

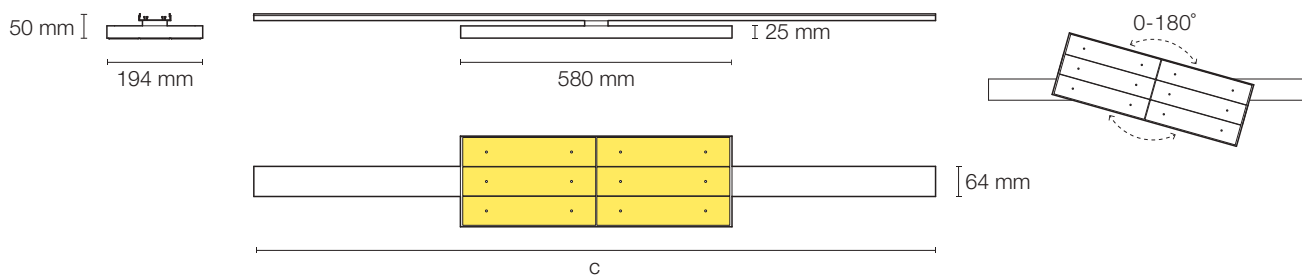

**QUICK INFO**

**GENERAL**

IP40  
 IK07  
 650°C  
 Class I  
 Ta= -20°C +40°C

**OPTIC**

PMMA Lens  
 UGR <19 (Lens 60°)

**LED**

Efficacy up to 187 lm/W  
 4000 K, 5000 K  
 CRI >80  
 Lifetime 54 000 H  
 L80/B10 @Tc=75°C

**ELETRICAL SYSTEM**

230V/50Hz  
 ON/OFF, DALI

**FINISHING**

RAL 9003 Matt White  
 RAL 9005 Matt Black

**OPTIONS**

**LED**

3000 K, 6500 K  
 CRI >90

**ELECTRICAL SYSTEM**

DSI, DIM 1-10V

**CONTROL SYSTEM**

Bluetooth

**FINISHING**

 Other Colours

**EMERGENCY**

1 Hour, 3 Hours  
 DALI 1 Hour, 3 Hours

**SENSORS**

Motion  
 Ambient Light  
 Motion & Ambient Light

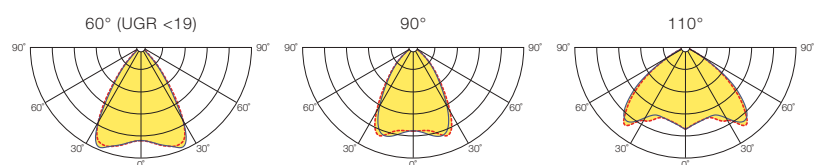



# HIPER IP40 ORIENTABLE PANEL

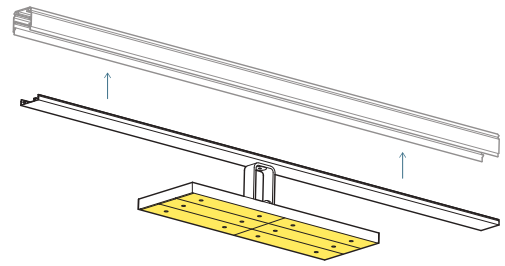

D2



## 4000 K

c (mm)	Output (lm)	System (W)	MATT WHITE		MATT BLACK		
			ON/OFF	DALI	ON/OFF	DALI	
<b>60°</b>							
	1435	6137	40	35.83.013.08.72	35.83.013.08.78	35.83.013.08.84	35.83.013.08.90
	2007	7566	51	35.83.013.08.73	35.83.013.08.79	35.83.013.08.85	35.83.013.08.91
<b>90°</b>							
	1435	5966	40	35.83.013.08.74	35.83.013.08.80	35.83.013.08.86	35.83.013.08.92
	2007	7345	51	35.83.013.08.75	35.83.013.08.81	35.83.013.08.87	35.83.013.08.93
<b>110°</b>							
	1435	6085	40	35.83.013.08.76	35.83.013.08.82	35.83.013.08.88	35.83.013.08.94
	2007	7492	51	35.83.013.08.77	35.83.013.08.83	35.83.013.08.89	35.83.013.08.95

## 5000 K

c (mm)	Output (lm)	System (W)	MATT WHITE		MATT BLACK		
			ON/OFF	DALI	ON/OFF	DALI	
<b>60°</b>							
	1435	6219	40	35.83.013.08.96	35.83.014.08.02	35.83.014.08.08	35.83.014.08.14
	2007	7665	51	35.83.013.08.97	35.83.014.08.03	35.83.014.08.09	35.83.014.08.15
<b>90°</b>							
	1435	6045	40	35.83.013.08.98	35.83.014.08.04	35.83.014.08.10	35.83.014.08.16
	2007	7451	51	35.83.013.08.99	35.83.014.08.05	35.83.014.08.11	35.83.014.08.17
<b>110°</b>							
	1435	6166	40	35.83.014.08.00	35.83.014.08.06	35.83.014.08.12	35.83.014.08.18
	2007	7600	51	35.83.014.08.01	35.83.014.08.07	35.83.014.08.13	35.83.014.08.19

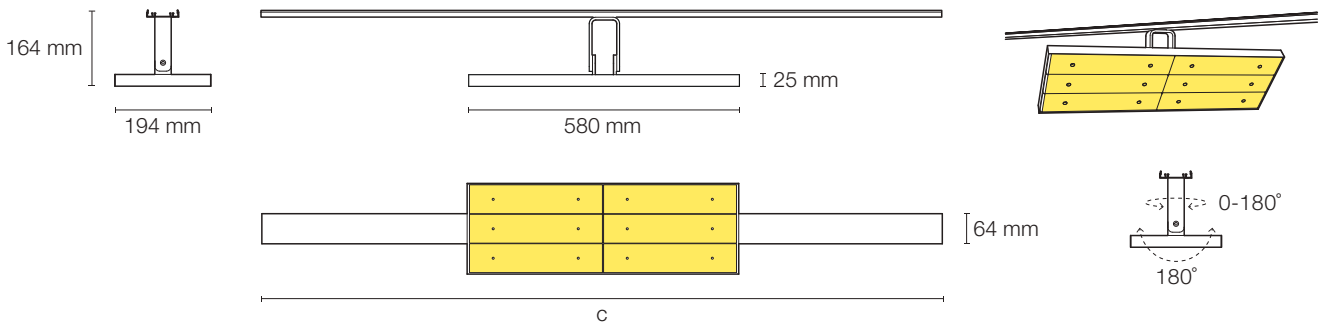

**QUICK INFO**

**GENERAL**

IP40  
 IK07  
 650°C  
 Class I  
 Ta= -20°C +40°C

**OPTIC**

PMMA Lens  
 UGR <19 (Lens 60°)

**LED**

Efficacy up to 187 lm/W  
 4000 K, 5000 K  
 CRI >80  
 Lifetime 54 000 H  
 L80/B10 @Tc=75°C

**ELETRICAL SYSTEM**

230V/50Hz  
 ON/OFF, DALI

**FINISHING**

RAL 9003 Matt White  
 RAL 9005 Matt Black

**OPTIONS**

**LED**

3000 K, 6500 K  
 CRI >90

**ELECTRICAL SYSTEM**

DSI, DIM 1-10V

**CONTROL SYSTEM**

Bluetooth

**FINISHING**

 Other Colours

**EMERGENCY**

1 Hour, 3 Hours  
 DALI 1 Hour, 3 Hours

**SENSORS**

Motion  
 Ambient Light  
 Motion & Ambient Light

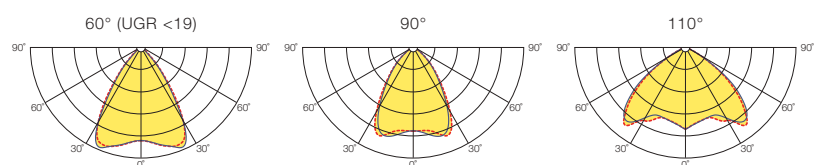

TECHNICAL SUSPENDED

# HIPER IP40 TRACK SPOTS

**E**

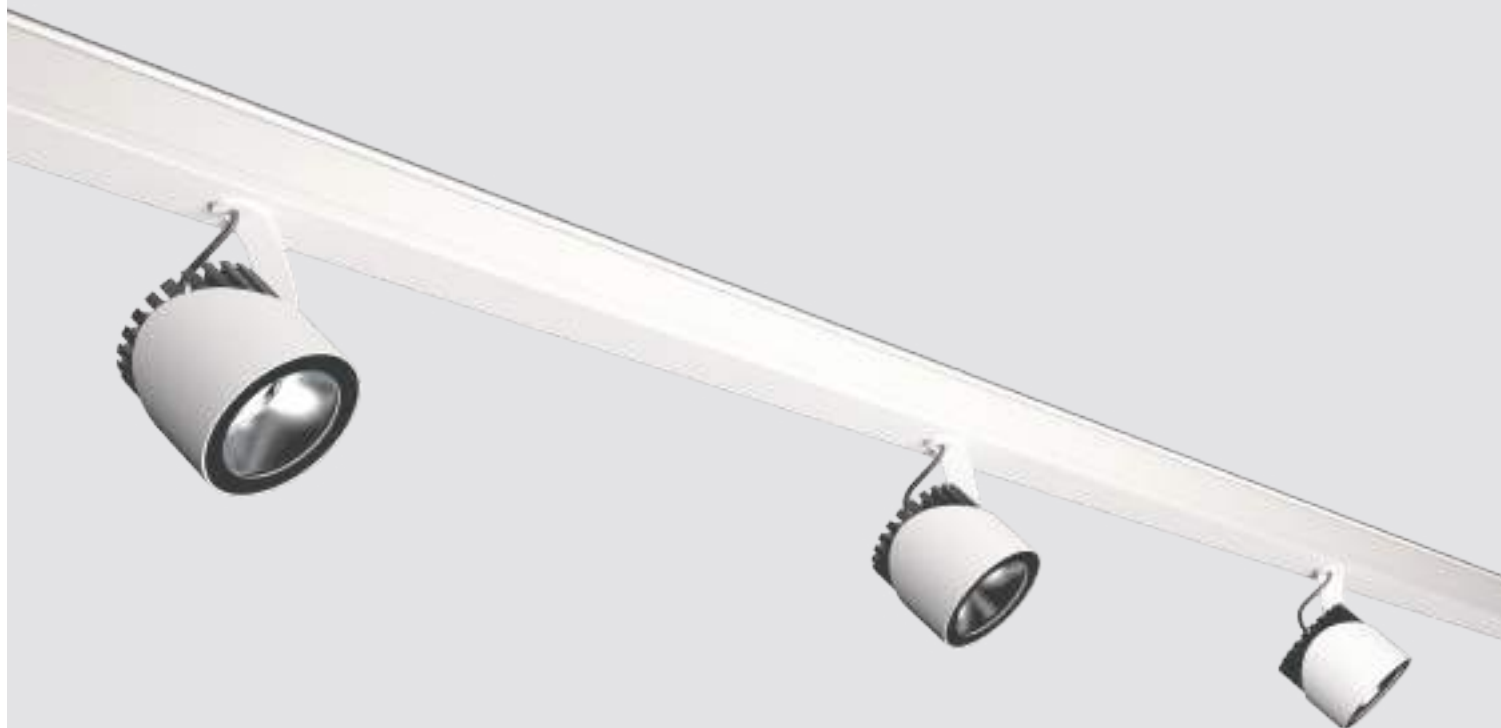



**QUICK INFO**

**GENERAL**

IP40  
 650°C  
 Class I  
 Ta= -20°C +40°C

**LED**

Efficacy up to 152 lm/W  
 4000 K, 5000 K  
 Specific Applications (Bread  
 Vegetables, Fish, Meat, Fashion)  
 CRI >80, CRI >90  
 Lifetime 51 000 H  
 L80/B10 @TC=65°C

**ELECTRICAL SYSTEM**

230V/50Hz  
 ON/OFF, DALI

**FINISHING**

RAL 9003 Matt White  
 RAL 9005 Matt Black

**OPTIONS**

**LED**

3000 K, 6500 K

**ELECTRICAL SYSTEM**

DSI, DIM 1-10V

**CONTROL SYSTEM**

Bluetooth

**FINISHING**

 Other Colours

**EMERGENCY**

1 Hour, 3 Hours  
 DALI 1 Hour, 3 Hours

**SENSORS**

Motion  
 Ambient Light  
 Motion & Ambient Light



**ROTATION**

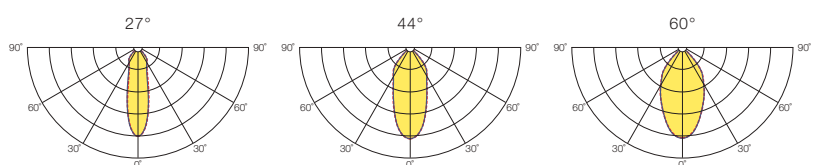
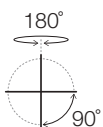

# HIPER IP40 TRACK SPOTS

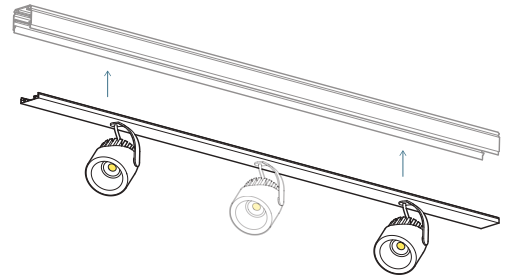

Track Spots 2 or 3

**CRI >80**

**4000 K**



c (mm)	Output (lm)	System (W)	Spots	MATT WHITE		MATT BLACK		
				ON/OFF	DALI	ON/OFF	DALI	
<b>27°</b>								
	PER SPOT	PER SPOT						
	1435	2876	27	2	35.83.014.08.44	35.83.007.08.24	35.83.007.08.28	35.83.007.08.32
				3	35.83.007.08.21	35.83.007.08.25	35.83.007.08.29	35.83.007.08.33
	2007	2876	27	2	35.83.007.08.22	35.83.007.08.26	35.83.007.08.30	35.83.007.08.34
				3	35.83.007.08.23	35.83.007.08.27	35.83.007.08.31	35.83.007.08.35
<b>44°</b>								
	1435	2839	27	2	35.83.007.08.36	35.83.007.08.40	35.83.007.08.44	35.83.007.08.48
				3	35.83.007.08.37	35.83.007.08.41	35.83.007.08.45	35.83.007.08.49
	2007	2839	27	2	35.83.007.08.38	35.83.007.08.42	35.83.007.08.46	35.83.007.08.50
				3	35.83.007.08.39	35.83.007.08.43	35.83.007.08.47	35.83.007.08.51
<b>60°</b>								
	1435	2907	27	2	35.83.007.08.52	35.83.007.08.56	35.83.007.08.60	35.83.007.08.64
				3	35.83.007.08.53	35.83.007.08.57	35.83.007.08.61	35.83.007.08.65
	2007	2907	27	2	35.83.007.08.54	35.83.007.08.58	35.83.007.08.62	35.83.007.08.66
				3	35.83.007.08.55	35.83.007.08.59	35.83.007.08.63	35.83.007.08.67

**5000 K**



c (mm)	Output (lm)	System (W)	Spots	MATT WHITE		MATT BLACK		
				ON/OFF	DALI	ON/OFF	DALI	
<b>27°</b>								
	PER SPOT	PER SPOT						
	1435	2963	27	2	35.83.007.08.68	35.83.007.08.72	35.83.007.08.76	35.83.007.08.80
				3	35.83.007.08.69	35.83.007.08.73	35.83.007.08.77	35.83.007.08.81
	2007	2963	27	2	35.83.007.08.70	35.83.007.08.74	35.83.007.08.78	35.83.007.08.82
				3	35.83.007.08.71	35.83.007.08.75	35.83.007.08.79	35.83.007.08.83
<b>44°</b>								
	1435	2925	27	2	35.83.007.08.84	35.83.007.08.88	35.83.007.08.92	35.83.007.08.96
				3	35.83.007.08.85	35.83.007.08.89	35.83.007.08.93	35.83.007.08.97
	2007	2925	27	2	35.83.007.08.86	35.83.007.08.90	35.83.007.08.94	35.83.007.08.98
				3	35.83.007.08.87	35.83.007.08.91	35.83.007.08.95	35.83.007.08.99
<b>60°</b>								
	1435	2996	27	2	35.83.008.08.00	35.83.008.08.04	35.83.008.08.08	35.83.008.08.12
				3	35.83.008.08.01	35.83.008.08.05	35.83.008.08.09	35.83.008.08.13
	2007	2996	27	2	35.83.008.08.02	35.83.008.08.06	35.83.008.08.10	35.83.008.08.14
				3	35.83.008.08.03	35.83.008.08.07	35.83.008.08.11	35.83.008.08.15

**CRI >90**

**4000 K**

	c (mm)	Output (lm)	System (W)	Spots	MATT WHITE		MATT BLACK	
					ON/OFF	DALI	ON/OFF	DALI
<b>27°</b>		PER SPOT	PER SPOT					
	1435	2461	27	2	35.83.008.08.16	35.83.008.08.20	35.83.008.08.24	35.83.008.08.28
				3	35.83.008.08.17	35.83.008.08.21	35.83.008.08.25	35.83.008.08.29
	2007	2461	27	2	35.83.008.08.18	35.83.008.08.22	35.83.008.08.26	35.83.008.08.30
				3	35.83.008.08.19	35.83.008.08.23	35.83.008.08.27	35.83.008.08.31
<b>44°</b>								
	1435	2429	27	2	35.83.008.08.32	35.83.008.08.36	35.83.008.08.40	35.83.008.08.44
				3	35.83.008.08.33	35.83.008.08.37	35.83.008.08.41	35.83.008.08.45
	2007	2429	27	2	35.83.008.08.34	35.83.008.08.38	35.83.008.08.42	35.83.008.08.46
				3	35.83.008.08.35	35.83.008.08.39	35.83.008.08.43	35.83.008.08.47
<b>60°</b>								
	1435	2488	27	2	35.83.008.08.48	35.83.008.08.52	35.83.008.08.56	35.83.008.08.60
				3	35.83.008.08.49	35.83.008.08.53	35.83.008.08.57	35.83.008.08.61
	2007	2488	27	2	35.83.008.08.50	35.83.008.08.54	35.83.008.08.58	35.83.008.08.62
				3	35.83.008.08.51	35.83.008.08.55	35.83.008.08.59	35.83.008.08.63

**5000 K**

	c (mm)	Output (lm)	System (W)	Spots	MATT WHITE		MATT BLACK	
					ON/OFF	DALI	ON/OFF	DALI
<b>27°</b>		PER SPOT	PER SPOT					
	1435	2522	27	2	35.83.008.08.64	35.83.008.08.68	35.83.008.08.72	35.83.008.08.76
				3	35.83.008.08.65	35.83.008.08.69	35.83.008.08.73	35.83.008.08.77
	2007	2522	27	2	35.83.008.08.66	35.83.008.08.70	35.83.008.08.74	35.83.008.08.78
				3	35.83.008.08.67	35.83.008.08.71	35.83.008.08.75	35.83.008.08.79
<b>44°</b>								
	1435	2490	27	2	35.83.008.08.80	35.83.008.08.84	35.83.008.08.88	35.83.008.08.92
				3	35.83.008.08.81	35.83.008.08.85	35.83.008.08.89	35.83.008.08.93
	2007	2490	27	2	35.83.008.08.82	35.83.008.08.86	35.83.008.08.90	35.83.008.08.94
				3	35.83.008.08.83	35.83.008.08.87	35.83.008.08.91	35.83.008.08.95
<b>60°</b>								
	1435	2550	27	2	35.83.008.08.96	35.83.009.08.00	35.83.009.08.04	35.83.009.08.08
				3	35.83.008.08.97	35.83.009.08.01	35.83.009.08.05	35.83.009.08.09
	2007	2550	27	2	35.83.008.08.98	35.83.009.08.02	35.83.009.08.06	35.83.009.08.10
				3	35.83.008.08.99	35.83.009.08.03	35.83.009.08.07	35.83.009.08.11

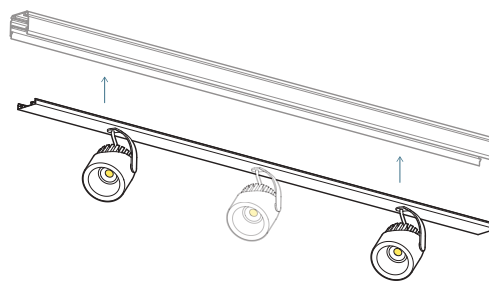

# HIPER IP40 TRACK SPOTS

## **E** SPECIFIC APPLICATIONS





Track Spots 2 or 3

### BREAD

	c (mm)	Output (lm)	System (W)	Spots	MATT WHITE		MATT BLACK	
					ON/OFF	DALI	ON/OFF	DALI
		PER SPOT	PER SPOT					
	1435	2647	27	2	35.83.002.08.41	35.83.002.08.45	35.83.002.08.49	35.83.002.08.53
				3	35.83.002.08.42	35.83.002.08.46	35.83.002.08.50	35.83.002.08.54
	2007	2647	27	2	35.83.002.08.43	35.83.002.08.47	35.83.002.08.51	35.83.002.08.55
				3	35.83.002.08.44	35.83.002.08.48	35.83.002.08.52	35.83.002.08.56
	1435	2645	27	2	35.83.002.08.57	35.83.002.08.61	35.83.002.08.65	35.83.002.08.69
				3	35.83.002.08.58	35.83.002.08.62	35.83.002.08.66	35.83.002.08.70
	2007	2645	27	2	35.83.002.08.59	35.83.002.08.63	35.83.002.08.67	35.83.002.08.71
				3	35.83.002.08.60	35.83.002.08.64	35.83.002.08.68	35.83.002.08.72
	1435	2639	27	2	35.83.002.08.73	35.83.002.08.77	35.83.002.08.81	35.83.002.08.85
				3	35.83.002.08.74	35.83.002.08.78	35.83.002.08.82	35.83.002.08.86
	2007	2639	27	2	35.83.002.08.75	35.83.002.08.79	35.83.002.08.83	35.83.002.08.87
				3	35.83.002.08.76	35.83.002.08.80	35.83.002.08.84	35.83.002.08.88



## VEGETABLES

	c (mm)	Output (lm)	System (W)	Spots	MATT WHITE		MATT BLACK	
					ON/OFF	DALI	ON/OFF	DALI
<b>27°</b>		PER SPOT	PER SPOT					
	1435	2531	27	2	35.83.002.08.89	35.83.002.08.93	35.83.002.08.97	35.83.003.08.01
				3	35.83.002.08.90	35.83.002.08.94	35.83.002.08.98	35.83.003.08.02
	2007	2531	27	2	35.83.002.08.91	35.83.002.08.95	35.83.002.08.99	35.83.003.08.03
				3	35.83.002.08.92	35.83.002.08.96	35.83.003.08.00	35.83.003.08.04
<b>44°</b>								
	1435	2529	27	2	35.83.003.08.05	35.83.003.08.09	35.83.003.08.13	35.83.003.08.17
				3	35.83.003.08.06	35.83.003.08.10	35.83.003.08.14	35.83.003.08.18
	2007	2529	27	2	35.83.003.08.07	35.83.003.08.11	35.83.003.08.15	35.83.003.08.19
				3	35.83.003.08.08	35.83.003.08.12	35.83.003.08.16	35.83.003.08.20
<b>60°</b>								
	1435	2523	27	2	35.83.003.08.21	35.83.003.08.25	35.83.003.08.29	35.83.003.08.33
				3	35.83.003.08.22	35.83.003.08.26	35.83.003.08.30	35.83.003.08.34
	2007	2523	27	2	35.83.003.08.23	35.83.003.08.27	35.83.003.08.31	35.83.003.08.35
				3	35.83.003.08.24	35.83.003.08.28	35.83.003.08.32	35.83.003.08.36



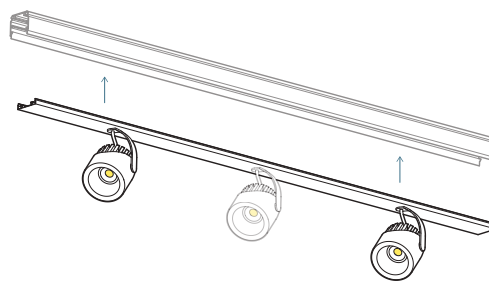

# HIPER IP40 TRACK SPOTS

## E SPECIFIC APPLICATIONS





Track Spots 2 or 3

### FISH

	c (mm)	Output (lm)	System (W)	Spots	MATT WHITE		MATT BLACK	
					ON/OFF	DALI	ON/OFF	DALI
<b>27°</b>								
		PER SPOT	PER SPOT					
	1435	2940	27	2	35.83.003.08.37	35.83.003.08.41	35.83.003.08.45	35.83.003.08.49
				3	35.83.003.08.38	35.83.003.08.42	35.83.003.08.46	35.83.003.08.50
	2007	2940	27	2	35.83.003.08.39	35.83.003.08.43	35.83.003.08.47	35.83.003.08.51
				3	35.83.003.08.40	35.83.003.08.44	35.83.003.08.48	35.83.003.08.52
<b>44°</b>								
	1435	2938	27	2	35.83.003.08.53	35.83.003.08.57	35.83.003.08.61	35.83.003.08.65
				3	35.83.003.08.54	35.83.003.08.58	35.83.003.08.62	35.83.003.08.66
	2007	2938	27	2	35.83.003.08.55	35.83.003.08.59	35.83.003.08.63	35.83.003.08.67
				3	35.83.003.08.56	35.83.003.08.60	35.83.003.08.64	35.83.003.08.68
<b>60°</b>								
	1435	2930	27	2	35.83.003.08.69	35.83.003.08.73	35.83.003.08.77	35.83.003.08.81
				3	35.83.003.08.70	35.83.003.08.74	35.83.003.08.78	35.83.003.08.82
	2007	2930	27	2	35.83.003.08.71	35.83.003.08.75	35.83.003.08.79	35.83.003.08.83
				3	35.83.003.08.72	35.83.003.08.76	35.83.003.08.80	35.83.003.08.84



## MEAT

	c (mm)	Output (lm)	System (W)	Spots	MATT WHITE		MATT BLACK	
					ON/OFF	DALI	ON/OFF	DALI
<b>27°</b>		PER SPOT	PER SPOT					
	1435	1804	27	2	35.83.003.08.85	35.83.003.08.89	35.83.003.08.93	35.83.003.08.97
				3	35.83.003.08.86	35.83.003.08.90	35.83.003.08.94	35.83.003.08.98
	2007	1804	27	2	35.83.003.08.87	35.83.003.08.91	35.83.003.08.95	35.83.003.08.99
				3	35.83.003.08.88	35.83.003.08.92	35.83.003.08.96	35.83.004.08.00
<b>44°</b>								
	1435	1802	27	2	35.83.004.08.01	35.83.004.08.05	35.83.004.08.09	35.83.004.08.13
				3	35.83.004.08.02	35.83.004.08.06	35.83.004.08.10	35.83.004.08.14
	2007	1802	27	2	35.83.004.08.03	35.83.004.08.07	35.83.004.08.11	35.83.004.08.15
				3	35.83.004.08.04	35.83.004.08.08	35.83.004.08.12	35.83.004.08.16
<b>60°</b>								
	1435	1798	27	2	35.83.004.08.17	35.83.004.08.21	35.83.004.08.25	35.83.004.08.29
				3	35.83.004.08.18	35.83.004.08.22	35.83.004.08.26	35.83.004.08.30
	2007	1798	27	2	35.83.004.08.19	35.83.004.08.23	35.83.004.08.27	35.83.004.08.31
				3	35.83.004.08.20	35.83.004.08.24	35.83.004.08.28	35.83.004.08.32



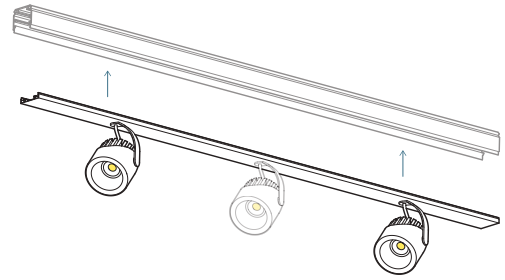

# HIPER IP40 TRACK SPOTS

## **E** SPECIFIC APPLICATIONS



Track Spots 2 or 3

## FASHION

	c (mm)	Output (lm)	System (W)	Spots	MATT WHITE		MATT BLACK	
					ON/OFF	DALI	ON/OFF	DALI
<b>27°</b>		PER SPOT	PER SPOT					
	1435	2648	27	2	35.83.004.08.33	35.83.004.08.37	35.83.004.08.41	35.83.004.08.45
				3	35.83.004.08.34	35.83.004.08.38	35.83.004.08.42	35.83.004.08.46
	2007	2648	27	2	35.83.004.08.35	35.83.004.08.39	35.83.004.08.43	35.83.004.08.47
				3	35.83.004.08.36	35.83.004.08.40	35.83.004.08.44	35.83.004.08.48
<b>44°</b>								
	1435	2646	27	2	35.83.004.08.49	35.83.004.08.53	35.83.004.08.57	35.83.004.08.61
				3	35.83.004.08.50	35.83.004.08.54	35.83.004.08.58	35.83.004.08.62
	2007	2646	27	2	35.83.004.08.51	35.83.004.08.55	35.83.004.08.59	35.83.004.08.63
				3	35.83.004.08.52	35.83.004.08.56	35.83.004.08.60	35.83.004.08.64
<b>60°</b>								
	1435	2640	27	2	35.83.004.08.65	35.83.004.08.69	35.83.004.08.73	35.83.004.08.77
				3	35.83.004.08.66	35.83.004.08.70	35.83.004.08.74	35.83.004.08.78
	2007	2640	27	2	35.83.004.08.67	35.83.004.08.71	35.83.004.08.75	35.83.004.08.79
				3	35.83.004.08.68	35.83.004.08.72	35.83.004.08.76	35.83.004.08.80

### TRACK SPOTS (2)

c= 1435 mm, a= 715 mm  
c= 2007 mm, a= 1000 mm

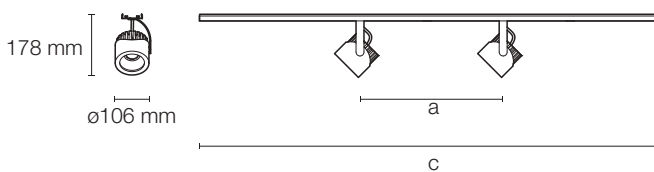

### TRACK SPOTS (3)

c= 1435 mm, a= 450 mm  
c= 2007 mm, a= 670 mm

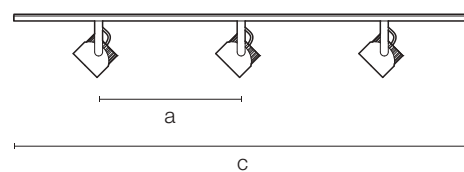





TECHNICAL SUSPENDED

# HIPER IP40 SUSPENDED SPOTS

F



**QUICK INFO**

**GENERAL**

IP40  
 650°C  
 Class I  
 Ta= -20°C +40°C

**LED**

Efficacy up to 167 lm/W  
 4000 K, 5000 K  
 Specific Applications (Bread  
 Vegetables, Fish, Meat, Fashion)  
 CRI >80, CRI >90  
 Lifetime 51 000 H  
 L80/B10 @TC=65°C

**ELECTRICAL SYSTEM**

230V/50Hz  
 ON/OFF, DALI

**FINISHING**

RAL 9003 Matt White  
 RAL 9005 Matt Black

**OPTIONS**

**LED**

3000 K, 6500 K

**ELECTRICAL SYSTEM**

DSI, DIM 1-10V

**CONTROL SYSTEM**

Bluetooth

**FINISHING**

 Other Colours

**EMERGENCY**

1 Hour, 3 Hours  
 DALI 1 Hour, 3 Hours

**SENSORS**

Motion  
 Ambient Light  
 Motion & Ambient Light

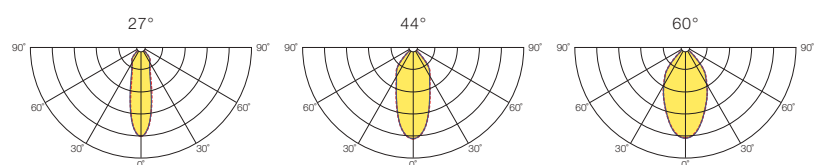

# HIPER IP40 SUSPENDED SPOTS



CRI >80

4000 K

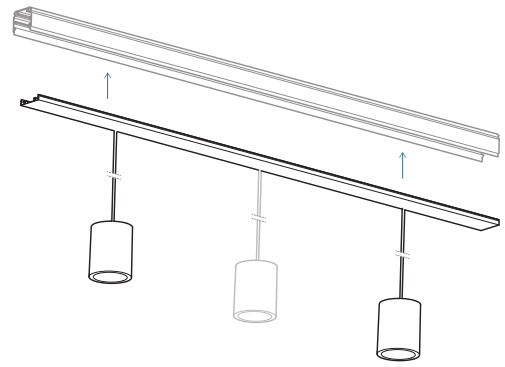

Suspended Spots 2 or 3



	c (mm)	Output (lm)	System (W)	Spots	MATT WHITE		MATT BLACK	
					ON/OFF	DALI	ON/OFF	DALI
<b>27°</b>		PER SPOT	PER SPOT					
	1435	2876	27	2	35.83.009.08.12	35.83.009.08.16	35.83.009.08.20	35.83.009.08.24
				3	35.83.009.08.13	35.83.009.08.17	35.83.009.08.21	35.83.009.08.25
	2007	2876	27	2	35.83.009.08.14	35.83.009.08.18	35.83.009.08.22	35.83.009.08.26
				3	35.83.009.08.15	35.83.009.08.19	35.83.009.08.23	35.83.009.08.27
<b>44°</b>								
	1435	2839	27	2	35.83.009.08.28	35.83.009.08.32	35.83.009.08.36	35.83.009.08.40
				3	35.83.009.08.29	35.83.009.08.33	35.83.009.08.37	35.83.009.08.41
	2007	2839	27	2	35.83.009.08.30	35.83.009.08.34	35.83.009.08.38	35.83.009.08.42
				3	35.83.009.08.31	35.83.009.08.35	35.83.009.08.39	35.83.009.08.43
<b>60°</b>								
	1435	2907	27	2	35.83.009.08.44	35.83.009.08.48	35.83.009.08.52	35.83.009.08.56
				3	35.83.009.08.45	35.83.009.08.49	35.83.009.08.53	35.83.009.08.57
	2007	2907	27	2	35.83.009.08.46	35.83.009.08.50	35.83.009.08.54	35.83.009.08.58
				3	35.83.009.08.47	35.83.009.08.51	35.83.009.08.55	35.83.009.08.59

5000 K



	c (mm)	Output (lm)	System (W)	Spots	MATT WHITE		MATT BLACK	
					ON/OFF	DALI	ON/OFF	DALI
<b>27°</b>		PER SPOT	PER SPOT					
	1435	2963	27	2	35.83.009.08.60	35.83.009.08.64	35.83.009.08.68	35.83.009.08.72
				3	35.83.009.08.61	35.83.009.08.65	35.83.009.08.69	35.83.009.08.73
	2007	2963	27	2	35.83.009.08.62	35.83.009.08.66	35.83.009.08.70	35.83.009.08.74
				3	35.83.009.08.63	35.83.009.08.67	35.83.009.08.71	35.83.009.08.75
<b>44°</b>								
	1435	2925	27	2	35.83.009.08.76	35.83.009.08.80	35.83.009.08.84	35.83.009.08.88
				3	35.83.009.08.77	35.83.009.08.81	35.83.009.08.85	35.83.009.08.89
	2007	2925	27	2	35.83.009.08.78	35.83.009.08.82	35.83.009.08.86	35.83.009.08.90
				3	35.83.009.08.79	35.83.009.08.83	35.83.009.08.87	35.83.009.08.91
<b>60°</b>								
	1435	2996	27	2	35.83.009.08.92	35.83.009.08.96	35.83.010.08.00	35.83.010.08.04
				3	35.83.009.08.93	35.83.009.08.97	35.83.010.08.01	35.83.010.08.05
	2007	2996	27	2	35.83.009.08.94	35.83.009.08.98	35.83.010.08.02	35.83.010.08.06
				3	35.83.009.08.95	35.83.009.08.99	35.83.010.08.03	35.83.010.08.07

**CRI >90**

**4000 K**

	c (mm)	Output (lm)	System (W)	Spots	MATT WHITE		MATT BLACK	
					ON/OFF	DALI	ON/OFF	DALI
<b>27°</b>		PER SPOT	PER SPOT					
	1435	2461	27	2	35.83.010.08.08	35.83.010.08.12	35.83.010.08.16	35.83.010.08.20
				3	35.83.010.08.09	35.83.010.08.13	35.83.010.08.17	35.83.010.08.21
	2007	2461	27	2	35.83.010.08.10	35.83.010.08.14	35.83.010.08.18	35.83.010.08.22
				3	35.83.010.08.11	35.83.010.08.15	35.83.010.08.19	35.83.010.08.23
<b>44°</b>								
	1435	2429	27	2	35.83.010.08.24	35.83.010.08.28	35.83.010.08.32	35.83.010.08.36
				3	35.83.010.08.25	35.83.010.08.29	35.83.010.08.33	35.83.010.08.37
	2007	2429	27	2	35.83.010.08.26	35.83.010.08.30	35.83.010.08.34	35.83.010.08.38
				3	35.83.010.08.27	35.83.010.08.31	35.83.010.08.35	35.83.010.08.39
<b>60°</b>								
	1435	2488	27	2	35.83.010.08.40	35.83.010.08.44	35.83.010.08.48	35.83.010.08.52
				3	35.83.010.08.41	35.83.010.08.45	35.83.010.08.49	35.83.010.08.53
	2007	2488	27	2	35.83.010.08.42	35.83.010.08.46	35.83.010.08.50	35.83.010.08.54
				3	35.83.010.08.43	35.83.010.08.47	35.83.010.08.51	35.83.010.08.55

**5000 K**

	c (mm)	Output (lm)	System (W)	Spots	MATT WHITE		MATT BLACK	
					ON/OFF	DALI	ON/OFF	DALI
<b>27°</b>		PER SPOT	PER SPOT					
	1435	2522	27	2	35.83.010.08.56	35.83.010.08.60	35.83.010.08.64	35.83.010.08.68
				3	35.83.010.08.57	35.83.010.08.61	35.83.010.08.65	35.83.010.08.69
	2007	2522	27	2	35.83.010.08.58	35.83.010.08.62	35.83.010.08.66	35.83.010.08.70
				3	35.83.010.08.59	35.83.010.08.63	35.83.010.08.67	35.83.010.08.71
<b>44°</b>								
	1435	2490	27	2	35.83.010.08.72	35.83.010.08.76	35.83.010.08.80	35.83.010.08.84
				3	35.83.010.08.73	35.83.010.08.77	35.83.010.08.81	35.83.010.08.85
	2007	2490	27	2	35.83.010.08.74	35.83.010.08.78	35.83.010.08.82	35.83.010.08.86
				3	35.83.010.08.75	35.83.010.08.79	35.83.010.08.83	35.83.010.08.87
<b>60°</b>								
	1435	2550	27	2	35.83.010.08.88	35.83.010.08.92	35.83.010.08.96	35.83.011.08.00
				3	35.83.010.08.89	35.83.010.08.93	35.83.010.08.97	35.83.011.08.01
	2007	2550	27	2	35.83.010.08.90	35.83.010.08.94	35.83.010.08.98	35.83.011.08.02
				3	35.83.010.08.91	35.83.010.08.95	35.83.010.08.99	35.83.011.08.03

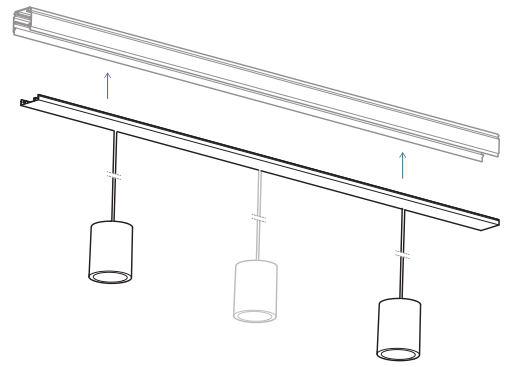

# HIPER IP40 SUSPENDED SPOTS

## F SPECIFIC APPLICATIONS





Suspended Spots 2 or 3

### BREAD

	c (mm)	Output (lm)	System (W)	Spots	MATT WHITE		MATT BLACK	
					ON/OFF	DALI	ON/OFF	DALI
		PER SPOT	PER SPOT					
	1435	2647	27	2	35.83.004.08.81	35.83.004.08.85	35.83.004.08.89	35.83.004.08.93
				3	35.83.004.08.82	35.83.004.08.86	35.83.004.08.90	35.83.004.08.94
	2007	2647	27	2	35.83.004.08.83	35.83.004.08.87	35.83.004.08.91	35.83.004.08.95
				3	35.83.004.08.84	35.83.004.08.88	35.83.004.08.92	35.83.004.08.96
	1435	2645	27	2	35.83.004.08.97	35.83.005.08.01	35.83.005.08.05	35.83.005.08.09
				3	35.83.004.08.98	35.83.005.08.02	35.83.005.08.06	35.83.005.08.10
	2007	2645	27	2	35.83.004.08.99	35.83.005.08.03	35.83.005.08.07	35.83.005.08.11
				3	35.83.005.08.00	35.83.005.08.04	35.83.005.08.08	35.83.005.08.12
	1435	2639	27	2	35.83.005.08.13	35.83.005.08.17	35.83.005.08.21	35.83.005.08.25
				3	35.83.005.08.14	35.83.005.08.18	35.83.005.08.22	35.83.005.08.26
	2007	2639	27	2	35.83.005.08.15	35.83.005.08.19	35.83.005.08.23	35.83.005.08.27
				3	35.83.005.08.16	35.83.005.08.20	35.83.005.08.24	35.83.005.08.28



## VEGETABLES

	c (mm)	Output (lm)	System (W)	Spots	MATT WHITE		MATT BLACK	
					ON/OFF	DALI	ON/OFF	DALI
<b>27°</b>		PER SPOT	PER SPOT					
	1435	2531	27	2	35.83.005.08.29	35.83.005.08.33	35.83.005.08.37	35.83.005.08.41
				3	35.83.005.08.30	35.83.005.08.34	35.83.005.08.38	35.83.005.08.42
	2007	2531	27	2	35.83.005.08.31	35.83.005.08.35	35.83.005.08.39	35.83.005.08.43
				3	35.83.005.08.32	35.83.005.08.36	35.83.005.08.40	35.83.005.08.44
<b>44°</b>								
	1435	2529	27	2	35.83.005.08.45	35.83.005.08.49	35.83.005.08.53	35.83.005.08.57
				3	35.83.005.08.46	35.83.005.08.50	35.83.005.08.54	35.83.005.08.58
	2007	2529	27	2	35.83.005.08.47	35.83.005.08.51	35.83.005.08.55	35.83.005.08.59
				3	35.83.005.08.48	35.83.005.08.52	35.83.005.08.56	35.83.005.08.60
<b>60°</b>								
	1435	2523	27	2	35.83.005.08.69	35.83.005.08.65	35.83.005.08.61	35.83.005.08.73
				3	35.83.005.08.70	35.83.005.08.66	35.83.005.08.62	35.83.005.08.74
	2007	2523	27	2	35.83.005.08.71	35.83.005.08.67	35.83.005.08.63	35.83.005.08.75
				3	35.83.005.08.72	35.83.005.08.68	35.83.005.08.64	35.83.005.08.76



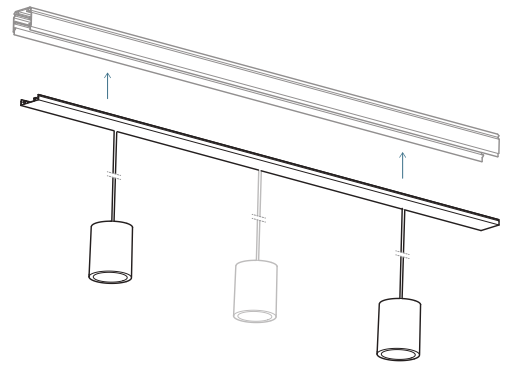

# HIPER IP40 SUSPENDED SPOTS

## F SPECIFIC APPLICATIONS



Suspended Spots 2 or 3



### FISH

	c (mm)	Output (lm)	System (W)	Spots	MATT WHITE		MATT BLACK	
					ON/OFF	DALI	ON/OFF	DALI
<b>27°</b>								
		PER SPOT	PER SPOT					
	1435	2940	27	2	35.83.005.08.77	35.83.005.08.81	35.83.005.08.85	35.83.005.08.89
				3	35.83.005.08.78	35.83.005.08.82	35.83.005.08.86	35.83.005.08.90
	2007	2940	27	2	35.83.005.08.79	35.83.005.08.83	35.83.005.08.87	35.83.005.08.91
				3	35.83.005.08.80	35.83.005.08.84	35.83.005.08.88	35.83.005.08.92
<b>44°</b>								
	1435	2938	27	2	35.83.005.08.93	35.83.005.08.97	35.83.006.08.01	35.83.006.08.05
				3	35.83.005.08.94	35.83.005.08.98	35.83.006.08.02	35.83.006.08.06
	2007	2938	27	2	35.83.005.08.95	35.83.005.08.99	35.83.006.08.03	35.83.006.08.07
				3	35.83.005.08.96	35.83.006.08.00	35.83.006.08.04	35.83.006.08.08
<b>60°</b>								
	1435	2930	27	2	35.83.006.08.09	35.83.006.08.13	35.83.006.08.17	35.83.006.08.21
				3	35.83.006.08.10	35.83.006.08.14	35.83.006.08.18	35.83.006.08.22
	2007	2930	27	2	35.83.006.08.11	35.83.006.08.15	35.83.006.08.19	35.83.006.08.23
				3	35.83.006.08.12	35.83.006.08.16	35.83.006.08.20	35.83.006.08.24





## MEAT

	c (mm)	Output (lm)	System (W)	Spots	MATT WHITE		MATT BLACK	
					ON/OFF	DALI	ON/OFF	DALI
<b>27°</b>		PER SPOT	PER SPOT					
	1435	1804	27	2	35.83.006.08.25	35.83.006.08.29	35.83.006.08.33	35.83.006.08.37
				3	35.83.006.08.26	35.83.006.08.30	35.83.006.08.34	35.83.006.08.38
	2007	1804	27	2	35.83.006.08.27	35.83.006.08.31	35.83.006.08.35	35.83.006.08.39
				3	35.83.006.08.28	35.83.006.08.32	35.83.006.08.36	35.83.006.08.40
<b>44°</b>								
	1435	1802	27	2	35.83.006.08.41	35.83.006.08.45	35.83.006.08.49	35.83.006.08.53
				3	35.83.006.08.42	35.83.006.08.46	35.83.006.08.50	35.83.006.08.54
	2007	1802	27	2	35.83.006.08.43	35.83.006.08.47	35.83.006.08.51	35.83.006.08.55
				3	35.83.006.08.44	35.83.006.08.48	35.83.006.08.52	35.83.006.08.56
<b>60°</b>								
	1435	1798	27	2	35.83.006.08.57	35.83.006.08.61	35.83.006.08.65	35.83.006.08.69
				3	35.83.006.08.58	35.83.006.08.62	35.83.006.08.66	35.83.006.08.70
	2007	1798	27	2	35.83.006.08.59	35.83.006.08.63	35.83.006.08.67	35.83.006.08.71
				3	35.83.006.08.60	35.83.006.08.64	35.83.006.08.68	35.83.006.08.72





# HIPER IP40 SUSPENDED SPOTS

## F SPECIFIC APPLICATIONS

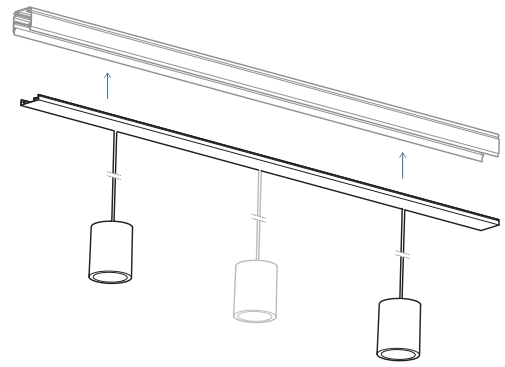
### FASHION



Suspended Spots 2 or 3

c (mm)	Output (lm)	System (W)	Spots	MATT WHITE		MATT BLACK		
				ON/OFF	DALI	ON/OFF	DALI	
<b>27°</b>								
	PER SPOT	PER SPOT						
	1435	2648	27	2	35.83.006.08.73	35.83.006.08.77	35.83.006.08.81	35.83.006.08.85
				3	35.83.006.08.74	35.83.006.08.78	35.83.006.08.82	35.83.006.08.86
	2007	2648	27	2	35.83.006.08.75	35.83.006.08.79	35.83.006.08.83	35.83.006.08.87
				3	35.83.006.08.76	35.83.006.08.80	35.83.006.08.84	35.83.006.08.88
<b>44°</b>								
	1435	2646	27	2	35.83.006.08.89	35.83.006.08.93	35.83.006.08.97	35.83.007.08.01
				3	35.83.006.08.90	35.83.006.08.94	35.83.006.08.98	35.83.007.08.02
	2007	2646	27	2	35.83.006.08.91	35.83.006.08.95	35.83.006.08.99	35.83.007.08.03
				3	35.83.006.08.92	35.83.006.08.96	35.83.007.08.00	35.83.007.08.04
<b>60°</b>								
	1435	2640	27	2	35.83.007.08.05	35.83.007.08.09	35.83.007.08.13	35.83.007.08.17
				3	35.83.007.08.06	35.83.007.08.10	35.83.007.08.14	35.83.007.08.18
	2007	2640	27	2	35.83.007.08.07	35.83.007.08.11	35.83.007.08.15	35.83.007.08.19
				3	35.83.007.08.08	35.83.007.08.12	35.83.007.08.16	35.83.007.08.20

#### SUSPENDED SPOTS (2)

c= 1435 mm, a= 715 mm  
c= 2007 mm, a= 1000 mm

#### SUSPENDED SPOTS (3)

c= 1435 mm, a= 450 mm  
c= 2007 mm, a= 670 mm

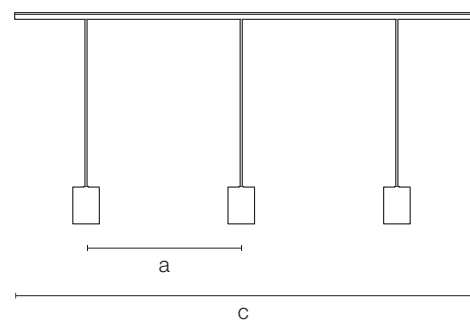
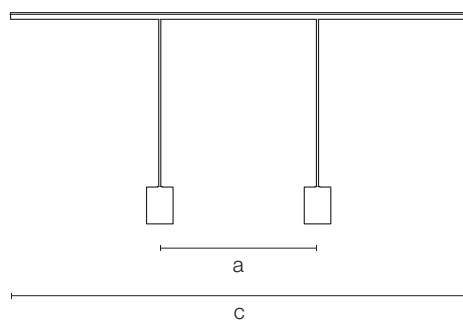
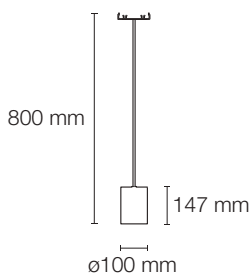



# HIPER IP40

## EME

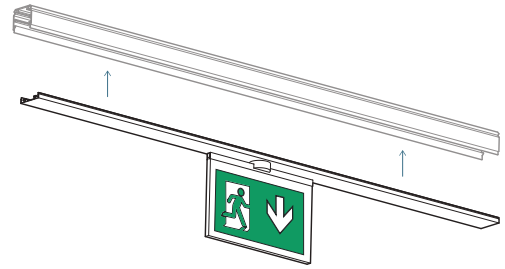

### 6500 K

c (mm)	System (W)	<sup>(1)</sup> DVM (m)	MATT WHITE	MATT BLACK
1435	1,4	20	35.83.014.08.20	35.83.014.08.22
2007	1,4	20	35.83.014.08.21	35.83.014.08.23

<sup>(1)</sup> DVM - Maximum Viewing Distance.

> EME with 3H Autonomy.

### PICTOGRAMS



TYPE		COD
EME - B	↓	35.83.001.08.73
EME - D	→	35.83.001.08.74
EME - E	←	35.83.001.08.75
EME - DD	↘	35.83.001.08.76
EME - DE	↙	35.83.001.08.77
EME - SD	↗	35.83.001.08.78
EME - SE	↖	35.83.001.08.79

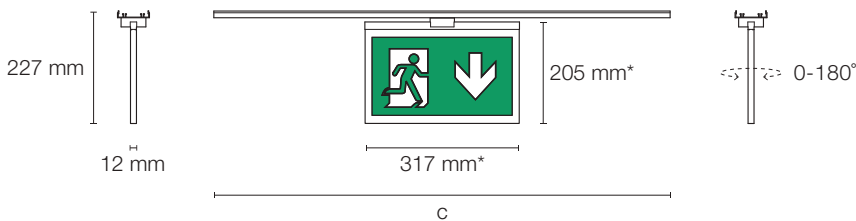

\* Other dimensions available on request.

**QUICK INFO**

**GENERAL**

IP40  
 650°C  
 Class I  
 Ta= -20°C +40°C

**OPTIC**

PMMA

**LED**

Efficacy up to 108 lm/W  
 6500 K  
 CRI >80  
 Lifetime 50 000 H  
 L70/B10 @TC=65°C

**EMERGENCY**

3 Hours  
 Maintained Mode

**ELETRICAL SYSTEM**

230V/50Hz  
 ON/OFF

**FINISHING**

RAL 9003 Matt White  
 RAL 9005 Matt Black

**OPTIONS**

**ELECTRICAL SYSTEM**

DALI

**FINISHING**

 Other Colours

**EMERGENCY**

DALI 3 Hours  
 Non-Maintained Mode

**SENSORS**

Motion

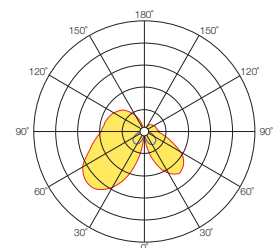

**HIPER IP40** INDIVIDUAL  
SUSPENDED



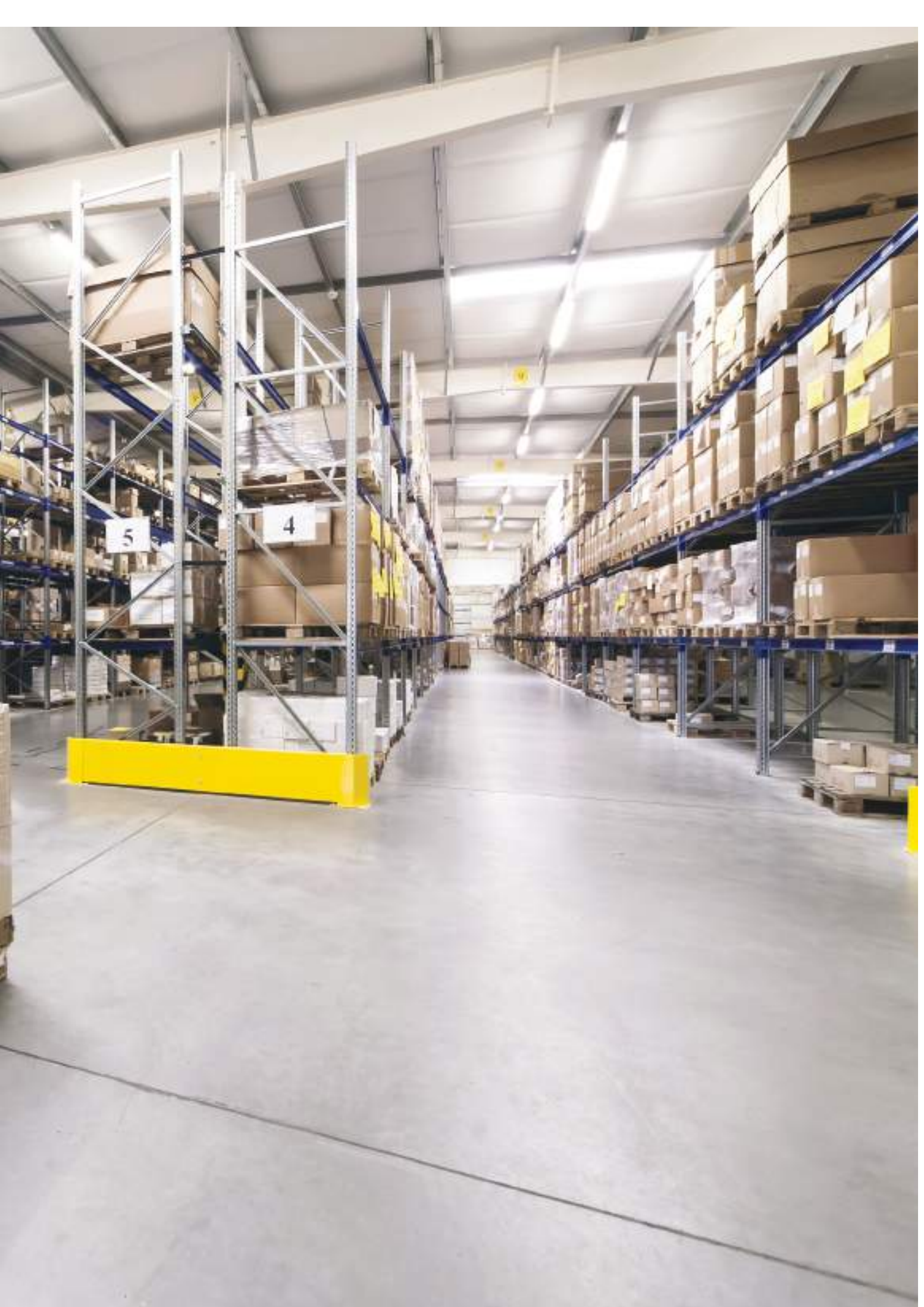

# HIPER IP40 INDIVIDUAL SUSPENDED



## PT

- > Luminária com emissão direta do fluxo luminoso.
- > Aplicação saliente no teto ou suspensa por cabos de aço inox.
- > Óticas com ângulo de abertura 60° (UGR <19), 90° ou 110°, bem como óticas com distribuição assimétrica e dupla assimétrica.
- > Corpo em perfil de alumínio extrudido com revestimento em poliéster.
- > Inclui topos em alumínio.

## ES

- > Luminaria con emisión directa del flujo luminoso.
- > Para el montaje directo en el techo o suspendida por cables de acero inoxidable.
- > Ópticas con ángulo de emisión 60° (UGR <19), 90° o 110°, así como ópticas con distribución asimétrica y doble asimétrica.
- > Cuerpo en perfil de aluminio extruido con recubrimiento de poliéster.
- > Incluye tapas finales en aluminio.

SUSPENDED



SURFACE





**QUICK INFO**

**GENERAL**

Suspended / Surface  
 IP40 (Optic)  
 IP20  
 IK07  
 650°C  
 Class I  
 Ta= -20°C +35°C

**OPTIC**

PMMA Lens  
 UGR <19 (Lens 60°)

**LED**

Efficacy up to 182 lm/W  
 3000 K, 4000 K  
 CRI >80  
 Lifetime 54 000 H  
 L80/B10 @TC=75°C

**ELECTRICAL SYSTEM**

230V/50Hz  
 ON/OFF, DALI

**FINISHING**

RAL 9003 Matt White  
 RAL 9005 Matt Black

**OPTIONS**

**LED**

5000 K, 6500 K  
 CRI >90

**ELECTRICAL SYSTEM**

DSI, DIM 1-10V

**CONTROL SYSTEM**

Bluetooth





**FINISHING**

 Other Colours

**SENSORS**

Motion  
 Ambient Light  
 Motion & Ambient Light

**OPTICAL LENS**

OPTIC TYPE		INDUSTRY	SHOP & RETAIL	EDUCATION	OFFICE
60° (UGR <19)		✓	✓	✓	✓
90°		✓	✓	✗	✗
110°		✓	✓	✗	✗
Asymmetric		✓	✓	✓	✓
Double Asymmetric		✓	✓	✓	✗

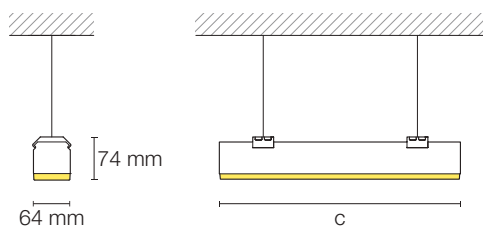
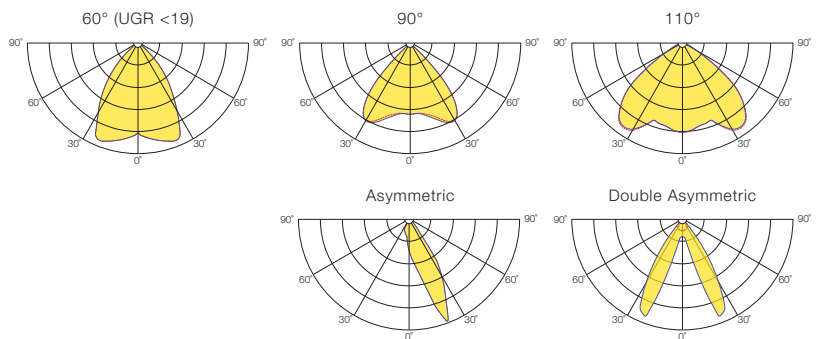

# HIPER IP40 INDIVIDUAL

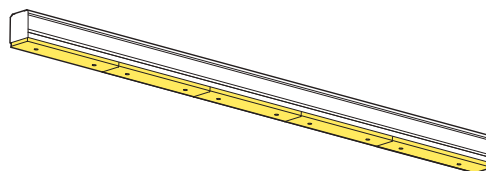

## HOUSING + OPTICAL LENS

### 3000 K

c (mm)	Output (lm)	System (W)	MATT WHITE		MATT BLACK	
			ON/OFF	DALI	ON/OFF	DALI
<b>60°</b>						
1440	6435	42	33.83.011.08.32	33.83.011.08.62	33.83.011.08.92	33.83.012.08.22
	8780	61	33.83.011.08.33	33.83.011.08.63	33.83.011.08.93	33.83.012.08.23
	16462	129	33.83.011.08.34	33.83.011.08.64	33.83.011.08.94	33.83.012.08.24
	9010	59	33.83.011.08.35	33.83.011.08.65	33.83.011.08.95	33.83.012.08.25
	12292	85	33.83.011.08.36	33.83.011.08.66	33.83.011.08.96	33.83.012.08.26
23048	181	33.83.011.08.37	33.83.011.08.67	33.83.011.08.97	33.83.012.08.27	
<b>90°</b>						
1440	6196	42	33.83.011.08.38	33.83.011.08.68	33.83.011.08.98	33.83.012.08.28
	8453	61	33.83.011.08.39	33.83.011.08.69	33.83.011.08.99	33.83.012.08.29
	15850	129	33.83.011.08.40	33.83.011.08.70	33.83.012.08.00	33.83.012.08.30
	8674	59	33.83.011.08.41	33.83.011.08.71	33.83.012.08.01	33.83.012.08.31
	11834	85	33.83.011.08.42	33.83.011.08.72	33.83.012.08.02	33.83.012.08.32
22189	181	33.83.011.08.43	33.83.011.08.73	33.83.012.08.03	33.83.012.08.33	
<b>110°</b>						
1440	6300	42	33.83.011.08.44	33.83.011.08.74	33.83.012.08.04	33.83.012.08.34
	8595	61	33.83.011.08.45	33.83.011.08.75	33.83.012.08.05	33.83.012.08.35
	16115	129	33.83.011.08.46	33.83.011.08.76	33.83.012.08.06	33.83.012.08.36
	8819	59	33.83.011.08.47	33.83.011.08.77	33.83.012.08.07	33.83.012.08.37
	12033	85	33.83.011.08.48	33.83.011.08.78	33.83.012.08.08	33.83.012.08.38
22561	181	33.83.011.08.49	33.83.011.08.79	33.83.012.08.09	33.83.012.08.39	
<b>ASYMMETRIC</b>						
1440	6354	42	33.83.011.08.50	33.83.011.08.80	33.83.012.08.10	33.83.012.08.40
	8668	61	33.83.011.08.51	33.83.011.08.81	33.83.012.08.11	33.83.012.08.41
	16253	129	33.83.011.08.52	33.83.011.08.82	33.83.012.08.12	33.83.012.08.42
	8895	59	33.83.011.08.53	33.83.011.08.83	33.83.012.08.13	33.83.012.08.43
	12136	85	33.83.011.08.54	33.83.011.08.84	33.83.012.08.14	33.83.012.08.44
22754	181	33.83.011.08.55	33.83.011.08.85	33.83.012.08.15	33.83.012.08.45	
<b>DOUBLE ASYMMETRIC</b>						
1440	6333	42	33.83.011.08.56	33.83.011.08.86	33.83.012.08.16	33.83.012.08.46
	8640	61	33.83.011.08.57	33.83.011.08.87	33.83.012.08.17	33.83.012.08.47
	16200	129	33.83.011.08.58	33.83.011.08.88	33.83.012.08.18	33.83.012.08.48
	8866	59	33.83.011.08.59	33.83.011.08.89	33.83.012.08.19	33.83.012.08.49
	12096	85	33.83.011.08.60	33.83.011.08.90	33.83.012.08.20	33.83.012.08.50
22680	181	33.83.011.08.61	33.83.011.08.91	33.83.012.08.21	33.83.012.08.51	



**4000 K**

c (mm)	Output (lm)	System (W)	MATT WHITE		MATT BLACK	
			ON/OFF	DALI	ON/OFF	DALI
<b>60°</b>						
1440	6909	42	33.83.012.08.52	33.83.012.08.82	33.83.013.08.12	33.83.013.08.42
	9428	61	33.83.012.08.53	33.83.012.08.83	33.83.013.08.13	33.83.013.08.43
	17660	129	33.83.012.08.54	33.83.012.08.84	33.83.013.08.14	33.83.013.08.44
	9673	59	33.83.012.08.55	33.83.012.08.85	33.83.013.08.15	33.83.013.08.45
	13200	85	33.83.012.08.56	33.83.012.08.86	33.83.013.08.16	33.83.013.08.46
2012	24724	181	33.83.012.08.57	33.83.012.08.87	33.83.013.08.17	33.83.013.08.47
<b>90°</b>						
1440	6652	42	33.83.012.08.58	33.83.012.08.88	33.83.013.08.18	33.83.013.08.48
	9077	61	33.83.012.08.59	33.83.012.08.89	33.83.013.08.19	33.83.013.08.49
	17002	129	33.83.012.08.60	33.83.012.08.90	33.83.013.08.20	33.83.013.08.50
	9313	59	33.83.012.08.61	33.83.012.08.91	33.83.013.08.21	33.83.013.08.51
	12708	85	33.83.012.08.62	33.83.012.08.92	33.83.013.08.22	33.83.013.08.52
2012	23803	181	33.83.012.08.63	33.83.012.08.93	33.83.013.08.23	33.83.013.08.53
<b>110°</b>						
1440	6763	42	33.83.012.08.64	33.83.012.08.94	33.83.013.08.24	33.83.013.08.54
	9230	61	33.83.012.08.65	33.83.012.08.95	33.83.013.08.25	33.83.013.08.55
	17287	129	33.83.012.08.66	33.83.012.08.96	33.83.013.08.26	33.83.013.08.56
	9469	59	33.83.012.08.67	33.83.012.08.97	33.83.013.08.27	33.83.013.08.57
	12921	85	33.83.012.08.68	33.83.012.08.98	33.83.013.08.28	33.83.013.08.58
2012	24202	181	33.83.012.08.69	33.83.012.08.99	33.83.013.08.29	33.83.013.08.59
<b>ASYMMETRIC</b>						
1440	6821	42	33.83.012.08.70	33.83.013.08.00	33.83.013.08.30	33.83.013.08.60
	9309	61	33.83.012.08.71	33.83.013.08.01	33.83.013.08.31	33.83.013.08.61
	17435	129	33.83.012.08.72	33.83.013.08.02	33.83.013.08.32	33.83.013.08.62
	9550	59	33.83.012.08.73	33.83.013.08.03	33.83.013.08.33	33.83.013.08.63
	13032	85	33.83.012.08.74	33.83.013.08.04	33.83.013.08.34	33.83.013.08.64
2012	24409	181	33.83.012.08.75	33.83.013.08.05	33.83.013.08.35	33.83.013.08.65
<b>DOUBLE ASYMMETRIC</b>						
1440	6799	42	33.83.012.08.76	33.83.013.08.06	33.83.013.08.36	33.83.013.08.66
	9278	61	33.83.012.08.77	33.83.013.08.07	33.83.013.08.37	33.83.013.08.67
	17378	129	33.83.012.08.78	33.83.013.08.08	33.83.013.08.38	33.83.013.08.68
	9519	59	33.83.012.08.79	33.83.013.08.09	33.83.013.08.39	33.83.013.08.69
	12990	85	33.83.012.08.80	33.83.013.08.10	33.83.013.08.40	33.83.013.08.70
2012	24330	181	33.83.012.08.81	33.83.013.08.11	33.83.013.08.41	33.83.013.08.71

# HIPER IP40 INDIVIDUAL

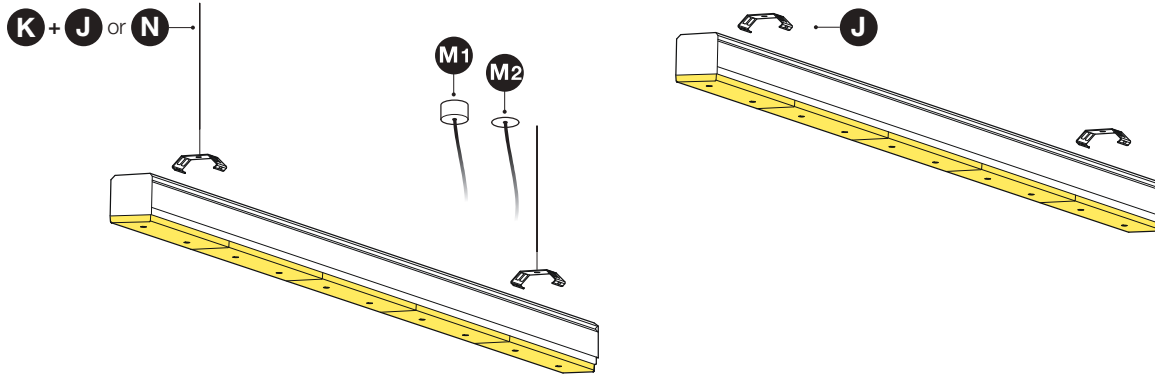

## COMPONENTS

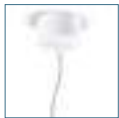

### M1 SURFACE CEILING CUP (1pc)

MATT WHITE	DIMENSION	1m	3m	5m
ON/OFF	Ø62x36 mm	35.83.001.08.93	35.83.001.08.94	35.83.001.08.95
ON/OFF + EM	Ø62x36 mm	35.83.001.08.96	35.83.001.08.97	35.83.001.08.98
DALI	Ø62x36 mm	35.83.001.08.99	35.83.002.08.00	35.83.002.08.01
DALI + EM	Ø103x36 mm	35.83.002.08.02	35.83.002.08.03	35.83.002.08.04



### M2 RECESSED CEILING CUP (1pc)

MATT WHITE	DIMENSION	1m	3m	5m
ON/OFF	Ø80 mm	35.83.002.08.17	35.83.002.08.18	35.83.002.08.19
ON/OFF + EM	Ø80 mm	35.83.002.08.20	35.83.002.08.21	35.83.002.08.22
DALI	Ø80 mm	35.83.002.08.23	35.83.002.08.24	35.83.002.08.25
DALI + EM	Ø80 mm	35.83.002.08.26	35.83.002.08.27	35.83.002.08.28



### J FIXING CLAMP (1pc)

TYPE	COD
Suspended/Surface Stainless Steel Clamp	35.83.000.08.48



### K SUSPENSION SYSTEM (1pc)

TYPE	FIG	3m	5m	10m
Stainless Steel Cable - Screw	1	61.01.83.000.00	61.01.83.000.01	61.01.83.000.02
Stainless Steel Cable - Tie	2	61.01.83.000.03	61.01.83.000.04	61.01.83.000.05



**GRIPPLE®** Certified Suspension

### N SUSPENSION SYSTEM (2pcs)

TYPE	1m	3m	5m
Matt White + Stainless Steel Cable	35.83.001.08.83	35.83.001.08.84	35.83.001.08.85

**OPTIONS**



**EMERGENCY (EM) - SELF-TEST INTEGRATED**

<b>ON/OFF</b>	<b>COD</b>
EM 1H 4,4W	35.00.004.01.17
EM 3H 4,4W	35.00.004.01.18
<b>DALI</b>	<b>COD</b>
EM 1H 5,4W DALI	35.00.004.01.63
EM 3H 5,4W DALI	35.00.004.01.64

**INSTALLATION**

**SURFACE MOUNTING**

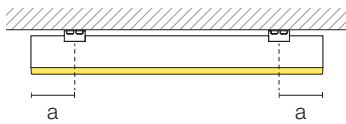

Recommended Spacing  
a: 100 to 250 mm

**SUSPENDED MOUNTING**

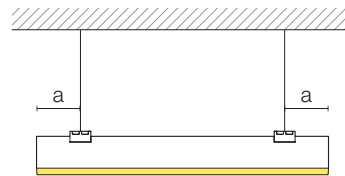

Recommended Spacing  
a: 100 to 250 mm

**HIPER IP54** INDIVIDUAL  
SUSPENDED





> **HIPER IP54** SUSPENDED

# HIPER IP54 INDIVIDUAL SUSPENDEDO



## PT

- > Luminária com emissão direta do fluxo luminoso e índice de proteção IP54.
- > Aplicação saliente no teto ou suspensa por cabos de aço inox.
- > Óticas com distribuição uniforme em duas opções de ângulo de abertura: 60° (UGR <90) ou 90°.
- > Corpo em perfil de alumínio extrudido com revestimento em poliéster.
- > Inclui topos em alumínio.

## ES

- > Luminaria con emisión directa del flujo luminoso y grado de protección IP54.
- > Para el montaje directo en el techo o suspendida por cables de acero inoxidable.
- > Ópticas con distribución uniforme en dos opciones de ángulo de emisión: 60° (UGR <90) o 90°.
- > Cuerpo en perfil de aluminio extruido con recubrimiento de poliéster.
- > Incluye tapas finales en aluminio.

SUSPENDEDO

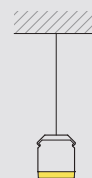

SURFACE





**QUICK INFO**

**GENERAL**

Suspended / Surface  
 IP54  
 IK07  
 650°C  
 Class I  
 Ta= -20°C +35°C

**OPTIC**

PMMA Lens  
 UGR <19 (Lens 60°)

**LED**

Efficacy up to 182 lm/W  
 3000 K, 4000 K  
 CRI >80  
 Lifetime 54 000 H  
 L80/B10 @Tc=75°C

**ELETRICAL SYSTEM**

230V/50Hz  
 ON/OFF, DALI

**FINISHING**

RAL 9003 Matt White  
 Matt Anodized

**OPTIONS**

**LED**

5000 K, 6500 K  
 CRI >90

**ELECTRICAL SYSTEM**

DSI, DIM 1-10V

**CONTROL SYSTEM**

Bluetooth

**FINISHING**

Other Colours

**SENSORS**

Motion  
 Ambient Light  
 Motion & Ambient Light

**OPTICAL LENS**

OPTIC TYPE		INDUSTRY	SHOP & RETAIL	EDUCATION	OFFICE
60° (UGR <19)		✓	✓	✓	✓
90°		✓	✓	✗	✗

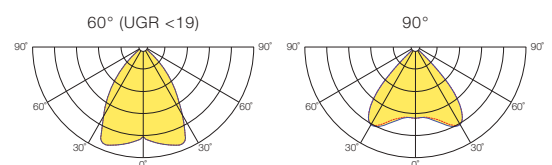
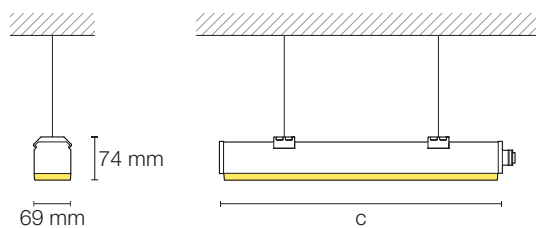

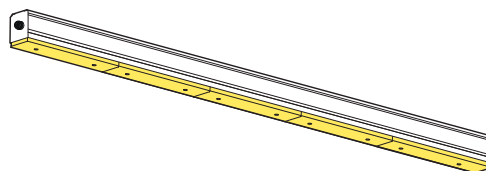

# HIPER IP54 INDIVIDUAL

## HOUSING + OPTICAL LENS

### 4000 K

c (mm)	Output (lm)	System (W)	MATT WHITE		MATT ANODIZED	
			ON/OFF	DALI	ON/OFF	DALI
<b>60°</b>						
1517	6396	42	33.83.004.08.41	33.83.004.08.65	33.83.004.08.53	33.83.004.08.77
	8728	61	33.83.004.08.42	33.83.004.08.66	33.83.004.08.54	33.83.004.08.78
	16348	129	33.83.004.08.43	33.83.004.08.67	33.83.004.08.55	33.83.004.08.79
	12792	85	33.83.004.08.44	33.83.004.08.68	33.83.004.08.56	33.83.004.08.80
	17456	121	33.83.004.08.45	33.83.004.08.69	33.83.004.08.57	33.83.004.08.81
	32696	259	33.83.004.08.46	33.83.004.08.70	33.83.004.08.58	33.83.004.08.82
<b>90°</b>						
1517	6325	42	33.83.004.08.47	33.83.004.08.71	33.83.004.08.59	33.83.004.08.83
	8631	61	33.83.004.08.48	33.83.004.08.72	33.83.004.08.60	33.83.004.08.84
	16166	129	33.83.004.08.49	33.83.004.08.73	33.83.004.08.61	33.83.004.08.85
	12649	85	33.83.004.08.50	33.83.004.08.74	33.83.004.08.62	33.83.004.08.86
	17262	121	33.83.004.08.51	33.83.004.08.75	33.83.004.08.63	33.83.004.08.87
	32331	259	33.83.004.08.52	33.83.004.08.76	33.83.004.08.64	33.83.004.08.88

### 5000 K

c (mm)	Output (lm)	System (W)	MATT WHITE		MATT ANODIZED	
			ON/OFF	DALI	ON/OFF	DALI
<b>60°</b>						
1517	6488	42	33.83.004.08.89	33.83.005.08.13	33.83.005.08.01	33.83.005.08.25
	8867	61	33.83.004.08.90	33.83.005.08.14	33.83.005.08.02	33.83.005.08.26
	16602	129	33.83.004.08.91	33.83.005.08.15	33.83.005.08.03	33.83.005.08.27
	12977	85	33.83.004.08.92	33.83.005.08.16	33.83.005.08.04	33.83.005.08.28
	17734	121	33.83.004.08.93	33.83.005.08.17	33.83.005.08.05	33.83.005.08.29
	33204	259	33.83.004.08.94	33.83.005.08.18	33.83.005.08.06	33.83.005.08.30
<b>90°</b>						
1517	6416	42	33.83.004.08.95	33.83.005.08.19	33.83.005.08.07	33.83.005.08.31
	8768	61	33.83.004.08.96	33.83.005.08.20	33.83.005.08.08	33.83.005.08.32
	16417	129	33.83.004.08.97	33.83.005.08.21	33.83.005.08.09	33.83.005.08.33
	12832	85	33.83.004.08.98	33.83.005.08.22	33.83.005.08.10	33.83.005.08.34
	17536	121	33.83.004.08.99	33.83.005.08.23	33.83.005.08.11	33.83.005.08.35
	32834	259	33.83.005.08.00	33.83.005.08.24	33.83.005.08.12	33.83.005.08.36

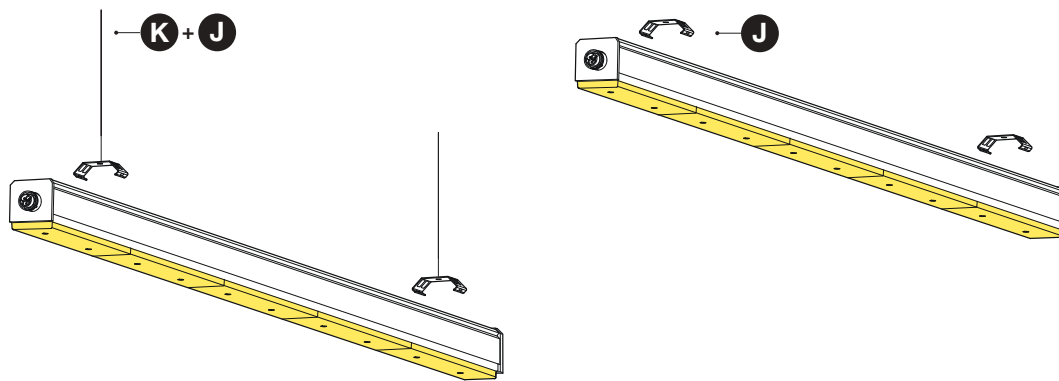

**COMPONENTS**



**J FIXING CLAMP (1pc)**

TYPE	COD
Suspended/Surface Stainless Steel Clamp	35.83.000.08.48



**K SUSPENSION SYSTEM (1pc)**

TYPE	FIG	3m	5m	10m
Stainless Steel Cable - Screw	1	61.01.83.000.00	61.01.83.000.01	61.01.83.000.02
Stainless Steel Cable - Tie	2	61.01.83.000.03	61.01.83.000.04	61.01.83.000.05

**GRIPPLE**® Certified Suspension



**OPTIONS**



**EMERGENCY (EM) - SELF-TEST INTEGRATED**

ON/OFF	COD
EM 1H 4,4W	35.00.004.01.17
EM 3H 4,4W	35.00.004.01.18

DALI	COD
EM 1H 5,4W DALI	35.00.004.01.63
EM 3H 5,4W DALI	35.00.004.01.64

**INSTALLATION**

**SURFACE MOUNTING**

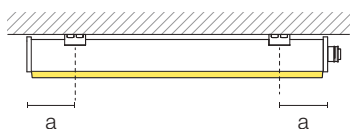

Recommended Spacing  
a: 100 to 250 mm

**SUSPENDED MOUNTING**

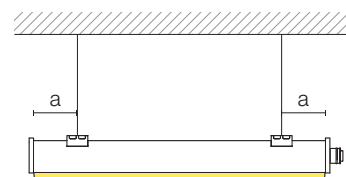

Recommended Spacing  
a: 100 to 250 mm



# CLEANROOM OVERVIEW

## ASEPTIC EXTREME

PAG 556

GENERAL	OPTICS	DIMENSIONS	APPLICATIONS
IP65	Opal Polycarbonate + Clear Glass	595x595 mm	> Operating Theatres
Surface / Recessed	Micro Prismatic PMMA + Clear Glass	295x1195 mm	> Laboratoires
Front Access		295x1495 mm	> Electronics Industry
Built-in Pressure Equalization Valve			> Genetic Engineering

## ASEPTIC ADVANCED

PAG 566

GENERAL	OPTICS	DIMENSIONS	APPLICATIONS
IP65 (Optic), IP54	Opal Polycarbonate	620x620 mm	> Pharmaceutical Industry
Recessed	Micro Prismatic PMMA + Clear Glass	320x1220 mm	> Chemical Industry
Front Access		320x1520 mm	> Intensive Care Units
			> Treatment Rooms

## ASEPTIC REGULAR

PAG 570

GENERAL	OPTICS	DIMENSIONS	APPLICATIONS
IP54 (Optic), IP20	Opal Polycarbonate	595x595 mm	> Health and Rehab Centers
Recessed	Micro Prismatic PMMA + Clear Glass	295x1195 mm	> Examination Rooms
Front Access		320x1495 mm	> Food Industry
			> Laundries

## ASEPTIC WALK-ON

PAG 574

GENERAL	OPTICS	DIMENSIONS	APPLICATIONS
IP65 (Optic), IP54	Opal Polycarbonate + Clear Glass	600x600 mm	> Pharmaceutical Industry
Recessed	Micro Prismatic PMMA + Clear Glass	600x1200 mm	> Chemical Industry
Top Access			> Intensive Care Units
			> Treatment Rooms

# ASEPTIC EXTREME RECESSED





# ASEPTIC EXTREME SURFACE

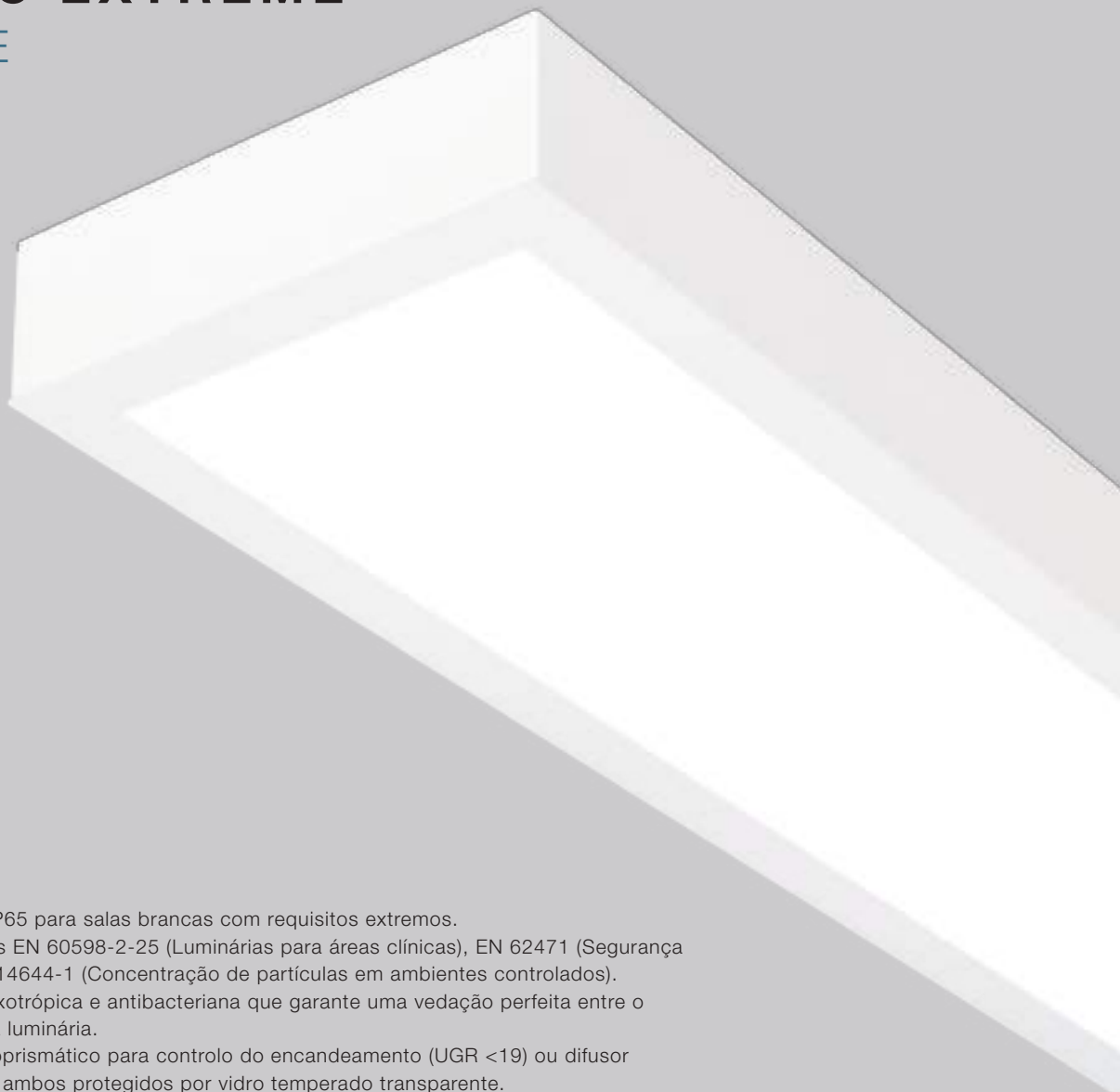

## PT

- > Luminária saliente IP65 para salas brancas com requisitos extremos.
- > Conforme as normas EN 60598-2-25 (Luminárias para áreas clínicas), EN 62471 (Segurança fotobiológica) e EN 14644-1 (Concentração de partículas em ambientes controlados).
- > Junta em espuma tixotrópica e antibacteriana que garante uma vedação perfeita entre o difusor e o corpo da luminária.
- > Difusor PMMA Microprismático para controlo do encandeamento (UGR <19) ou difusor Policarbonato Opal, ambos protegidos por vidro temperado transparente.
- > Com válvula de equalização de pressão incorporada para evitar condensação.
- > Aro em alumínio sem parafusos visíveis e corpo em chapa de aço com revestimento a epoxy-poliéster resistente a desinfetantes e produtos de limpeza.
- > Revestimento a pó antibacteriano disponível sob consulta.

## ES

- > Luminaria de superficie IP65 para salas blancas con requisitos extremos.
- > De acuerdo a las normativas EN 60598-2-25 (Luminarias para áreas clínicas), EN 62471 (Seguridad fotobiológica) e EN 14644-1 (Concentración de partículas en locales controlados).
- > Junta de espuma tixotrópica y antibacteriana para un sellado confiable entre el difusor y el cuerpo de la luminaria.
- > Difusor PMMA Microprismático para control del deslumbramiento (UGR <19) o difusor Policarbonato Opal, ambos protegidos por vidrio templado transparente.
- > Con válvula de compensación de presión incorporada para evitar la condensación.
- > Marco frontal en aluminio sin tornillos visibles y cuerpo de chapa de acero con recubrimiento epoxi-poliéster resistente a los desinfectantes y productos de limpieza.
- > Recubrimiento a polvo antibacteriano disponible bajo consulta.



**QUICK INFO**

**GENERAL**

Surface  
 IP65  
 IK09  
 960°C  
 Class I  
 Ta= -20°C +35°C

**OPTIC**

Opal Polycarbonate  
 + Clear Tempered Glass

**LED**

Efficacy up to 193 lm/W  
 3000 K, 4000 K, 5000K  
 CRI >80, CRI >90  
 Lifetime 72 000 H  
 L80/B10 @Tc=85°C

**ELETRICAL SYSTEM**

230V/50Hz  
 ON/OFF, DALI

**FINISHING**

RAL 9003 Matt White

**OPTIONS**

**ELECTRICAL SYSTEM**

DSI, DIM 1-10V

**FINISHING**

Antibacterial Coating  
 Stainless Steel 304/316  
 Other Colours

**EMERGENCY**

1 Hour, 3 Hours  
 DALI 1 Hour, 3 Hours

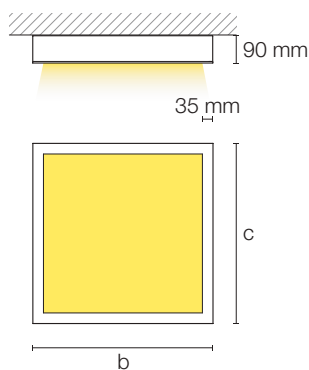

**ASEPTIC EXTREME SURFACE**

**OPAL DIFFUSER + CLEAR GLASS**

CRI >80

bxc (mm)	Output (lm)	System (W)	ON/OFF	DALI
<b>3000 K</b>				
595x595	3386	33	33.12.710.00000	33.12.710.00012
	4321	44	33.12.710.00001	33.12.710.00013
295x1195	5875	57	33.12.710.00002	33.12.710.00014
	7808	80	33.12.710.00003	33.12.710.00015
295x1495	7343	72	33.12.710.00004	33.12.710.00016
	9761	100	33.12.710.00005	33.12.710.00017
<b>4000 K</b>				
595x595	3580	33	33.12.710.00048	33.12.710.00060
	4569	44	33.12.710.00049	33.12.710.00061
295x1195	6148	57	33.12.710.00050	33.12.710.00062
	8170	80	33.12.710.00051	33.12.710.00063
295x1495	7685	72	33.12.710.00052	33.12.710.00064
	10213	100	33.12.710.00053	33.12.710.00065
<b>5000 K</b>				
595x595	3607	33	33.12.710.00096	33.12.710.00108
	4509	44	33.12.710.00097	33.12.710.00109
295x1195	6148	57	33.12.710.00098	33.12.710.00110
	8170	80	33.12.710.00099	33.12.710.00111
295x1495	7685	72	33.12.710.00100	33.12.710.00112
	10213	100	33.12.710.00101	33.12.710.00113

CRI >90

bxc (mm)	Output (lm)	System (W)	ON/OFF	DALI
<b>3000 K</b>				
595x595	2427	27	33.12.710.00024	33.12.710.00036
	3509	40	33.12.710.00025	33.12.710.00037
295x1195	5067	58	33.12.710.00026	33.12.710.00038
	6731	80	33.12.710.00027	33.12.710.00039
295x1495	6332	72	33.12.710.00028	33.12.710.00040
	8414	100	33.12.710.00029	33.12.710.00041
<b>4000 K</b>				
595x595	2591	27	33.12.710.00072	33.12.710.00084
	3747	40	33.12.710.00073	33.12.710.00085
295x1195	5288	58	33.12.710.00074	33.12.710.00086
	7026	80	33.12.710.00075	33.12.710.00087
295x1495	6609	72	33.12.710.00076	33.12.710.00088
	8783	100	33.12.710.00077	33.12.710.00089

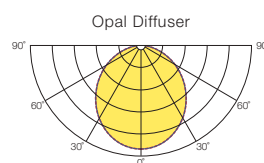

**QUICK INFO**

**GENERAL**

Surface  
 IP65  
 IK09  
 960°C  
 Class I  
 Ta= -20°C +35°C

**OPTIC**

Micro Prismatic PMMA (UGR <19)  
 + Clear Tempered Glass

**LED**

Efficacy up to 193 lm/W  
 3000 K, 4000 K, 5000K  
 CRI >80, CRI >90  
 Lifetime 72 000 H  
 L80/B10 @Tc=85°C

**ELETRICAL SYSTEM**

230V/50Hz  
 ON/OFF, DALI

**FINISHING**

RAL 9003 Matt White

**OPTIONS**

**ELECTRICAL SYSTEM**

DSI, DIM 1-10V

**FINISHING**

Antibacterial Coating  
 Stainless Steel 304/316  
 Other Colours

**EMERGENCY**

1 Hour, 3 Hours  
 DALI 1 Hour, 3 Hours

**ASEPTIC EXTREME SURFACE**

**MICRO PRISMATIC DIFFUSER (UGR <19) + CLEAR GLASS**

CRI >80

bxc (mm)	Output (lm)	System (W)	ON/OFF	DALI
<b>3000 K</b>				
595x595	4015	33	33.12.710.00006	33.12.710.00018
	5123	44	33.12.710.00007	33.12.710.00019
295x1195	7090	57	33.12.710.00008	33.12.710.00020
	9424	80	33.12.710.00009	33.12.710.00021
295x1495	8863	72	33.12.710.00010	33.12.710.00022
	11780	100	33.12.710.00011	33.12.710.00023
<b>4000 K</b>				
595x595	4245	33	33.12.710.00054	33.12.710.00066
	5418	44	33.12.710.00055	33.12.710.00067
295x1195	7420	57	33.12.710.00056	33.12.710.00068
	9861	80	33.12.710.00057	33.12.710.00069
295x1495	9275	72	33.12.710.00058	33.12.710.00070
	12326	100	33.12.710.00059	33.12.710.00071
<b>5000 K</b>				
595x595	4277	33	33.12.710.00102	33.12.710.00114
	5347	44	33.12.710.00103	33.12.710.00115
295x1195	7420	57	33.12.710.00104	33.12.710.00116
	9861	80	33.12.710.00105	33.12.710.00117
295x1495	9275	72	33.12.710.00106	33.12.710.00118
	12326	100	33.12.710.00107	33.12.710.00119

CRI >90

bxc (mm)	Output (lm)	System (W)	ON/OFF	DALI
<b>3000 K</b>				
595x595	2877	27	33.12.710.00030	33.12.710.00042
	4161	40	33.12.710.00031	33.12.710.00043
295x1195	6115	58	33.12.710.00032	33.12.710.00044
	8124	80	33.12.710.00033	33.12.710.00045
295x1495	7643	72	33.12.710.00034	33.12.710.00046
	10155	100	33.12.710.00035	33.12.710.00047
<b>4000 K</b>				
595x595	3072	27	33.12.710.00078	33.12.710.00090
	4443	40	33.12.710.00079	33.12.710.00091
295x1195	6382	58	33.12.710.00080	33.12.710.00092
	8480	80	33.12.710.00081	33.12.710.00093
295x1495	7977	72	33.12.710.00082	33.12.710.00094
	10600	100	33.12.710.00083	33.12.710.00095

Micro Prismatic Diffuser - UGR<19

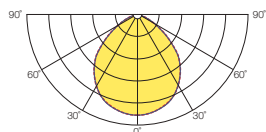

**OPTIONS**

**SUCTION CUP**



	DIMENSION	COD
Rubber Suction Cup (to assist in diffuser removal)	Ø80 mm	35.12.001.08.90



# ASEPTIC EXTREME

## RECESSED

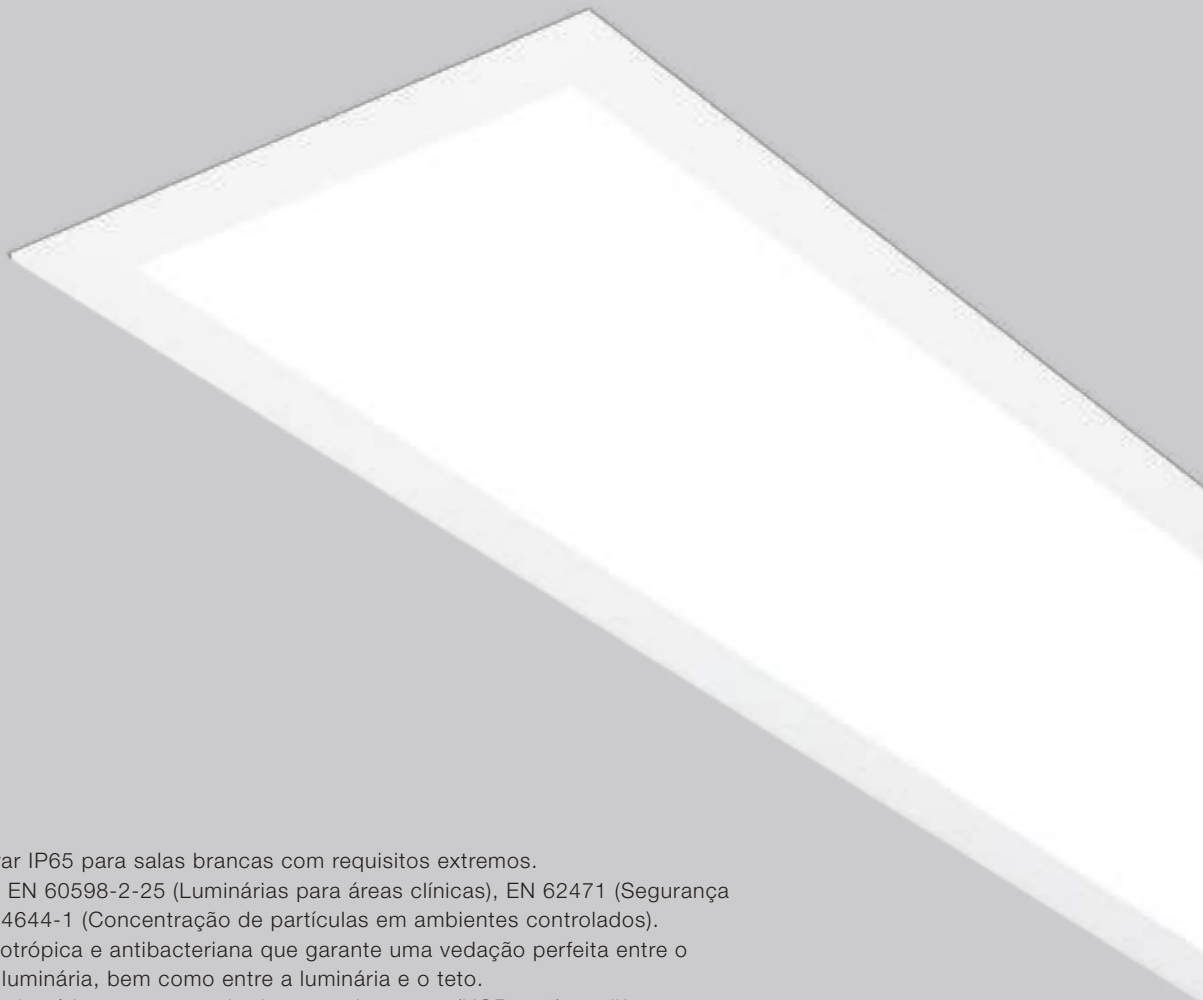

### PT

- > Luminária de encastrar IP65 para salas brancas com requisitos extremos.
- > Conforme as normas EN 60598-2-25 (Luminárias para áreas clínicas), EN 62471 (Segurança fotobiológica) e EN 14644-1 (Concentração de partículas em ambientes controlados).
- > Junta em espuma tixotrópica e antibacteriana que garante uma vedação perfeita entre o difusor e o corpo da luminária, bem como entre a luminária e o teto.
- > Difusor PMMA Microprismático para controlo do encandeamento (UGR <19) ou difusor Policarbonato Opal, ambos protegidos por vidro temperado transparente.
- > Com válvula de equalização de pressão incorporada para evitar condensação.
- > Aro em alumínio sem parafusos visíveis e corpo em chapa de aço com revestimento a epoxy-poliéster resistente a desinfetantes e produtos de limpeza.
- > Acesso pela parte inferior da luminária.

### ES

- > Luminaria de empotrar IP65 para salas blancas con requisitos extremos.
- > De acuerdo a las normativas EN 60598-2-25 (Luminarias para áreas clínicas), EN 62471 (Seguridad fotobiológica) e EN 14644-1 (Concentración de partículas en locales controlados).
- > Junta de espuma tixotrópica y antibacteriana para un sellado confiable entre el difusor y el cuerpo de la luminaria, así como entre la luminaria y el techo.
- > Difusor PMMA Microprismático para control del deslumbramiento (UGR <19) o difusor Policarbonato Opal, ambos protegidos por vidrio templado transparente.
- > Con válvula de compensación de presión incorporada para evitar la condensación.
- > Marco frontal en aluminio sin tornillos visibles y cuerpo de chapa de acero con recubrimiento epoxi-poliéster resistente a los desinfectantes y productos de limpieza.
- > Acceso por la parte inferior de la luminaria.

**QUICK INFO**

**GENERAL**

Recessed  
 IP65  
 IK09  
 960°C  
 Class I  
 Ta= -20°C +35°C

**OPTIC**

Opal Polycarbonate  
 + Clear Tempered Glass

**LED**

Efficacy up to 193 lm/W  
 3000 K, 4000 K, 5000K  
 CRI >80, CRI >90  
 Lifetime 72 000 H  
 L80/B10 @Tc=85°C

**ELECTRICAL SYSTEM**

230V/50Hz  
 ON/OFF, DALI

**FINISHING**

RAL 9003 Matt White

**OPTIONS**

**ELECTRICAL SYSTEM**

DSI, DIM 1-10V

**FINISHING**

Antibacterial Coating  
 Stainless Steel 304/316  
 Other Colours

**EMERGENCY**

1 Hour, 3 Hours  
 DALI 1 Hour, 3 Hours

**ASEPTIC EXTREME RECESSED  
 OPAL DIFFUSER + CLEAR GLASS**

CRI >80

bxc (mm)	Output (lm)	System (W)	ON/OFF	DALI
<b>3000 K</b>				
595x595	3386	33	33.12.711.00000	33.12.711.00012
	4321	44	33.12.711.00001	33.12.711.00013
295x1195	5875	57	33.12.711.00002	33.12.711.00014
	7808	80	33.12.711.00003	33.12.711.00015
295x1495	7343	72	33.12.711.00004	33.12.711.00016
	9761	100	33.12.711.00005	33.12.711.00017
<b>4000 K</b>				
595x595	3580	33	33.12.711.00048	33.12.711.00060
	4569	44	33.12.711.00049	33.12.711.00061
295x1195	6148	57	33.12.711.00050	33.12.711.00062
	8170	80	33.12.711.00051	33.12.711.00063
295x1495	7685	72	33.12.711.00052	33.12.711.00064
	10213	100	33.12.711.00053	33.12.711.00065
<b>5000 K</b>				
595x595	3607	33	33.12.711.00096	33.12.711.00108
	4509	44	33.12.711.00097	33.12.711.00109
295x1195	6148	57	33.12.711.00098	33.12.711.00110
	8170	80	33.12.711.00099	33.12.711.00111
295x1495	7685	72	33.12.711.00100	33.12.711.00112
	10213	100	33.12.711.00101	33.12.711.00113

CRI >90

bxc (mm)	Output (lm)	System (W)	ON/OFF	DALI
<b>3000 K</b>				
595x595	2427	27	33.12.711.00024	33.12.711.00036
	3509	40	33.12.711.00025	33.12.711.00037
295x1195	5067	58	33.12.711.00026	33.12.711.00038
	6731	80	33.12.711.00027	33.12.711.00039
295x1495	6332	72	33.12.711.00028	33.12.711.00040
	8414	100	33.12.711.00029	33.12.711.00041
<b>4000 K</b>				
595x595	2591	27	33.12.711.00072	33.12.711.00084
	3747	40	33.12.711.00073	33.12.711.00085
295x1195	5288	58	33.12.711.00074	33.12.711.00086
	7026	80	33.12.711.00075	33.12.711.00087
295x1495	6609	72	33.12.711.00076	33.12.711.00088
	8783	100	33.12.711.00077	33.12.711.00089

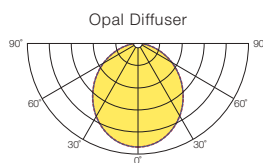
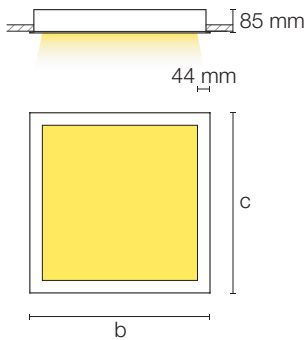

**QUICK INFO**

**GENERAL**

Recessed  
 IP65  
 IK09  
 960°C  
 Class I  
 Ta= -20°C +35°C

**OPTIC**

Micro Prismatic PMMA (UGR <19)  
 + Clear Tempered Glass

**LED**

Efficacy up to 193 lm/W  
 3000 K, 4000 K, 5000K  
 CRI >80, CRI >90  
 Lifetime 72 000 H  
 L80/B10 @Tc=85°C

**ELETRICAL SYSTEM**

230V/50Hz  
 ON/OFF, DALI

**FINISHING**

RAL 9003 Matt White

**OPTIONS**

**ELECTRICAL SYSTEM**

DSI, DIM 1-10V

**FINISHING**

Antibacterial Coating  
 Stainless Steel 304/316  
 Other Colours

**EMERGENCY**

1 Hour, 3 Hours  
 DALI 1 Hour, 3 Hours

**ASEPTIC EXTREME RECESSED**

**MICRO PRISMATIC DIFFUSER (UGR <19) + CLEAR GLASS**

CRI >80

bxc (mm)	Output (lm)	System (W)	ON/OFF	DALI
<b>3000 K</b>				
595x595	4015	33	33.12.711.00006	33.12.711.00018
	5123	44	33.12.711.00007	33.12.711.00019
295x1195	7090	57	33.12.711.00008	33.12.711.00020
	9424	80	33.12.711.00009	33.12.711.00021
295x1495	8863	72	33.12.711.00010	33.12.711.00022
	11780	100	33.12.711.00011	33.12.711.00023
<b>4000 K</b>				
595x595	4245	33	33.12.711.00054	33.12.711.00066
	5418	44	33.12.711.00055	33.12.711.00067
295x1195	7420	57	33.12.711.00056	33.12.711.00068
	9861	80	33.12.711.00057	33.12.711.00069
295x1495	9275	72	33.12.711.00058	33.12.711.00070
	12326	100	33.12.711.00059	33.12.711.00071
<b>5000 K</b>				
595x595	4277	33	33.12.711.00102	33.12.711.00114
	5347	44	33.12.711.00103	33.12.711.00115
295x1195	7420	57	33.12.711.00104	33.12.711.00116
	9861	80	33.12.711.00105	33.12.711.00117
295x1495	9275	72	33.12.711.00106	33.12.711.00118
	12326	100	33.12.711.00107	33.12.711.00119

CRI >90

bxc (mm)	Output (lm)	System (W)	ON/OFF	DALI
<b>3000 K</b>				
595x595	2877	27	33.12.711.00030	33.12.711.00042
	4161	40	33.12.711.00031	33.12.711.00043
295x1195	6115	58	33.12.711.00032	33.12.711.00044
	8124	80	33.12.711.00033	33.12.711.00045
295x1495	7643	72	33.12.711.00034	33.12.711.00046
	10155	100	33.12.711.00035	33.12.711.00047
<b>4000 K</b>				
595x595	3072	27	33.12.711.00078	33.12.711.00090
	4443	40	33.12.711.00079	33.12.711.00091
295x1195	6382	58	33.12.711.00080	33.12.711.00092
	8480	80	33.12.711.00081	33.12.711.00093
295x1495	7977	72	33.12.711.00082	33.12.711.00094
	10600	100	33.12.711.00083	33.12.711.00095

**OPTIONS**

**SUCTION CUP**



	DIMENSION	COD
Rubber Suction Cup (to assist in diffuser removal)	Ø80 mm	35.12.001.08.90

Micro Prismatic Diffuser - UGR<19

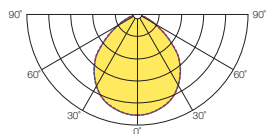



# ASEPTIC ADVANCED RECESSED

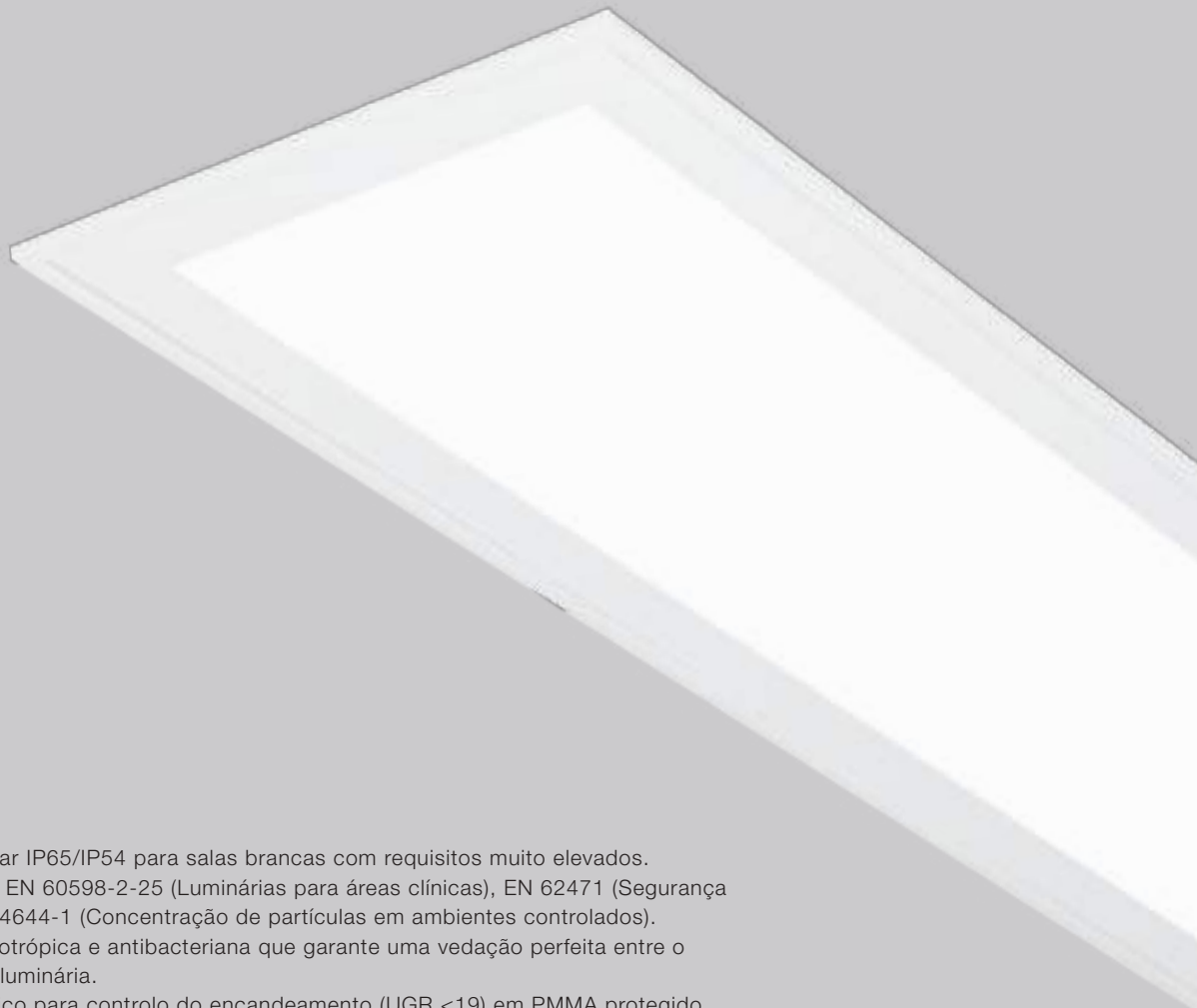

## PT

- > Luminária de encastrar IP65/IP54 para salas brancas com requisitos muito elevados.
- > Conforme as normas EN 60598-2-25 (Luminárias para áreas clínicas), EN 62471 (Segurança fotobiológica) e EN 14644-1 (Concentração de partículas em ambientes controlados).
- > Junta em espuma tixotrópica e antibacteriana que garante uma vedação perfeita entre o difusor e o corpo da luminária.
- > Difusor Microprismático para controlo do encandeamto (UGR <19) em PMMA protegido por vidro temperado transparente ou difusor Policarbonato Opal.
- > Aro em alumínio e corpo em chapa de aço com revestimento a epoxy-poliéster resistente a desinfetantes e produtos de limpeza.
- > Acesso pela parte inferior da luminária.

## ES

- > Luminaria de empotrar IP65/IP54 para salas blancas con requisitos muy elevados.
- > De acuerdo a las normativas EN 60598-2-25 (Luminarias para áreas clínicas), EN 62471 (Seguridad fotobiológica) e EN 14644-1 (Concentración de partículas en locales controlados).
- > Junta de espuma tixotrópica y antibacteriana para un sellado confiable entre el difusor y el cuerpo de la luminaria.
- > Difusor Microprismático para control del deslumbramiento (UGR <19) en PMMA protegido por vidrio templado transparente o difusor Policarbonato Opal.
- > Marco frontal en aluminio y cuerpo de chapa de acero con recubrimiento epoxi-poliéster resistente a los desinfectantes y productos de limpieza.
- > Acceso por la parte inferior de la luminaria.



**QUICK INFO**

**GENERAL**

Recessed  
 IP65 (Optic)  
 IP54  
 IK09  
 850°C  
 Class I  
 Ta= -20°C +35°C

**OPTIC**

Opal Polycarbonate

**LED**

Efficacy up to 193 lm/W  
 3000 K, 4000 K, 5000K  
 CRI >80, CRI >90  
 Lifetime 72 000 H  
 L80/B10 @Tc=85°C

**ELETRICAL SYSTEM**

230V/50Hz  
 ON/OFF, DALI

**FINISHING**

RAL 9003 Matt White

**OPTIONS**

**ELECTRICAL SYSTEM**

DSI, DIM 1-10V

**FINISHING**

Antibacterial Coating  
 Stainless Steel 304/316  
 Other Colours

**EMERGENCY**

1 Hour, 3 Hours  
 DALI 1 Hour, 3 Hours

**ASEPTIC ADVANCED RECESSED**

**OPAL DIFFUSER**

CRI >80

bxc (mm)	Output (lm)	System (W)	ON/OFF	DALI
<b>3000 K</b>				
620x620	3680	33	33.12.705.00000	33.12.705.00012
	4696	44	33.12.705.00001	33.12.705.00013
320x1220	6386	57	33.12.705.00002	33.12.705.00014
	8487	80	33.12.705.00003	33.12.705.00015
320x1520	7982	72	33.12.705.00004	33.12.705.00016
	10609	100	33.12.705.00005	33.12.705.00017
<b>4000 K</b>				
620x620	3891	33	33.12.705.00048	33.12.705.00060
	4967	44	33.12.705.00049	33.12.705.00061
320x1220	6682	57	33.12.705.00050	33.12.705.00062
	8881	80	33.12.705.00051	33.12.705.00063
320x1520	8353	72	33.12.705.00052	33.12.705.00064
	11101	100	33.12.705.00053	33.12.705.00065
<b>5000 K</b>				
620x620	3921	33	33.12.705.00096	33.12.705.00108
	4901	44	33.12.705.00097	33.12.705.00109
320x1220	6682	57	33.12.705.00098	33.12.705.00110
	8881	80	33.12.705.00099	33.12.705.00111
320x1520	8353	72	33.12.705.00100	33.12.705.00112
	11101	100	33.12.705.00101	33.12.705.00113

CRI >90

bxc (mm)	Output (lm)	System (W)	ON/OFF	DALI
<b>3000 K</b>				
620x620	2638	27	33.12.705.00024	33.12.705.00036
	3814	40	33.12.705.00025	33.12.705.00037
320x1220	5507	58	33.12.705.00026	33.12.705.00038
	7316	80	33.12.705.00027	33.12.705.00039
320x1520	6883	72	33.12.705.00028	33.12.705.00040
	9145	100	33.12.705.00029	33.12.705.00041
<b>4000 K</b>				
620x620	2816	27	33.12.705.00072	33.12.705.00084
	4073	40	33.12.705.00073	33.12.705.00085
320x1220	5748	58	33.12.705.00074	33.12.705.00086
	7637	80	33.12.705.00075	33.12.705.00087
320x1520	7184	72	33.12.705.00076	33.12.705.00088
	9546	100	33.12.705.00077	33.12.705.00089

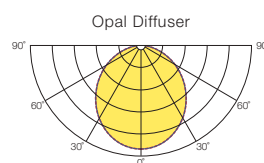
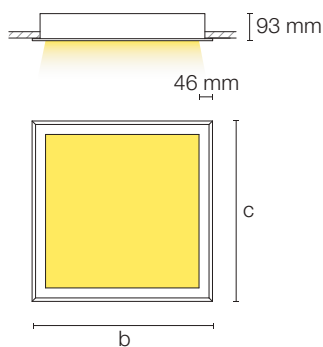

**QUICK INFO**

**GENERAL**

Recessed  
 IP65 (Optic)  
 IP54  
 IK09  
 960°C  
 Class I  
 Ta= -20°C +35°C

**OPTIC**

Micro Prismatic PMMA (UGR <19)  
 + Clear Tempered Glass

**LED**

Efficacy up to 193 lm/W  
 3000 K, 4000 K, 5000K  
 CRI >80, CRI >90  
 Lifetime 72 000 H  
 L80/B10 @Tc=85°C

**ELETRICAL SYSTEM**

230V/50Hz  
 ON/OFF, DALI

**FINISHING**

RAL 9003 Matt White

**OPTIONS**

**ELECTRICAL SYSTEM**

DSI, DIM 1-10V

**FINISHING**

Antibacterial Coating  
 Stainless Steel 304/316  
 Other Colours

**EMERGENCY**

1 Hour, 3 Hours  
 DALI 1 Hour, 3 Hours

**ASEPTIC ADVANCED RECESSED**

**MICRO PRISMATIC DIFFUSER (UGR <19) + CLEAR GLASS**

CRI >80

bxc (mm)	Output (lm)	System (W)	ON/OFF	DALI
<b>3000 K</b>				
620x620	4015	33	33.12.705.00006	33.12.705.00018
	5123	44	33.12.705.00007	33.12.705.00019
320x1220	7090	57	33.12.705.00008	33.12.705.00020
	9424	80	33.12.705.00009	33.12.705.00021
320x1520	8863	72	33.12.705.00010	33.12.705.00022
	11780	100	33.12.705.00011	33.12.705.00023
<b>4000 K</b>				
620x620	4245	33	33.12.705.00054	33.12.705.00066
	5418	44	33.12.705.00055	33.12.705.00067
320x1220	7420	57	33.12.705.00056	33.12.705.00068
	9861	80	33.12.705.00057	33.12.705.00069
320x1520	9275	72	33.12.705.00058	33.12.705.00070
	12326	100	33.12.705.00059	33.12.705.00071
<b>5000 K</b>				
620x620	4277	33	33.12.705.00102	33.12.705.00114
	5347	44	33.12.705.00103	33.12.705.00115
320x1220	7420	57	33.12.705.00104	33.12.705.00116
	9861	80	33.12.705.00105	33.12.705.00117
320x1520	9275	72	33.12.705.00106	33.12.705.00118
	12326	100	33.12.705.00107	33.12.705.00119

CRI >90

bxc (mm)	Output (lm)	System (W)	ON/OFF	DALI
<b>3000 K</b>				
620x620	2877	27	33.12.705.00030	33.12.705.00042
	4161	40	33.12.705.00031	33.12.705.00043
320x1220	6115	58	33.12.705.00032	33.12.705.00044
	8124	80	33.12.705.00033	33.12.705.00045
320x1520	7643	72	33.12.705.00034	33.12.705.00046
	10155	100	33.12.705.00035	33.12.705.00047
<b>4000 K</b>				
620x620	3072	27	33.12.705.00078	33.12.705.00090
	4443	40	33.12.705.00079	33.12.705.00091
320x1220	6382	58	33.12.705.00080	33.12.705.00092
	8480	80	33.12.705.00081	33.12.705.00093
320x1520	7977	72	33.12.705.00082	33.12.705.00094
	10600	100	33.12.705.00083	33.12.705.00095

**OPTIONS**

**SUCTION CUP**



	DIMENSION	COD
Rubber Suction Cup (to assist in diffuser removal)	Ø80 mm	35.12.001.08.90

Micro Prismatic Diffuser - UGR<19

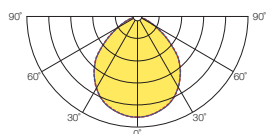



# ASEPTIC REGULAR

## RECESSED

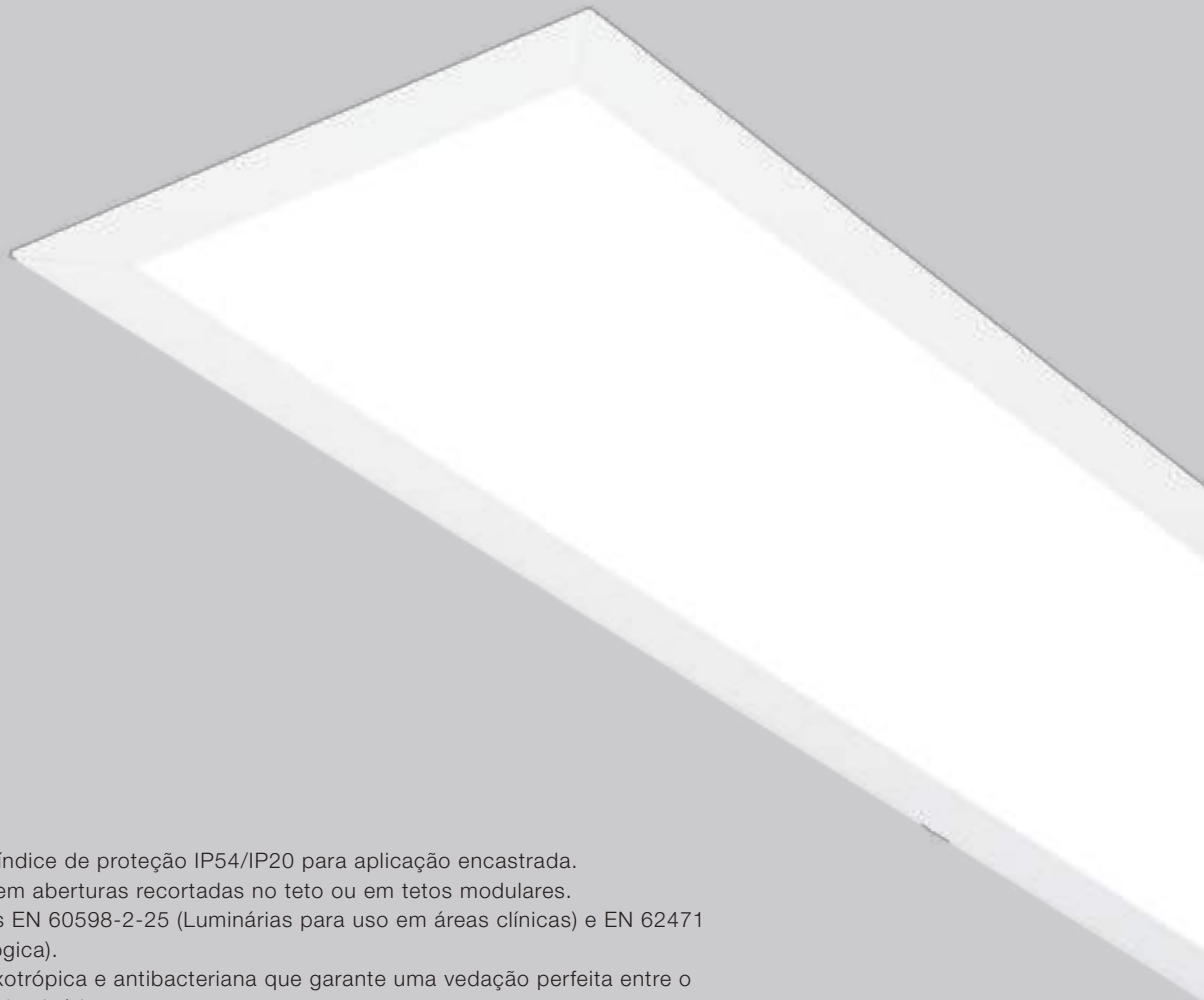

### PT

- > Luminária LED com índice de proteção IP54/IP20 para aplicação encastrada.
- > Aplicação universal em aberturas recortadas no teto ou em tetos modulares.
- > Conforme as normas EN 60598-2-25 (Luminárias para uso em áreas clínicas) e EN 62471 (Segurança fotobiológica).
- > Junta em espuma tixotrópica e antibacteriana que garante uma vedação perfeita entre o difusor e o corpo da luminária.
- > Difusor Microprismático para controlo do encandeamento (UGR <19) em PMMA protegido por vidro temperado transparente ou difusor Policarbonato Opal para luz difusa.
- > Aro em alumínio e corpo em chapa de aço com revestimento a epoxy-poliéster resistente a desinfetantes e produtos de limpeza.
- > Acesso pela parte inferior da luminária.

### ES

- > Luminaria LED con grado de protección IP54/IP20 para instalación empotrada.
- > Aplicación universal en huecos recortados en el techo o en techos modulares.
- > De acuerdo a las normativas EN 60598-2-25 (Luminarias para uso en áreas clínicas) e EN 62471 (Seguridad fotobiológica).
- > Junta de espuma tixotrópica y antibacteriana para un sellado confiable entre el difusor y el cuerpo de la luminaria.
- > Difusor Microprismático para control del deslumbramiento (UGR <19) en PMMA protegido por vidrio templado transparente o difusor Policarbonato Opal.
- > Marco frontal en aluminio y cuerpo de chapa de acero con recubrimiento epoxi-poliéster resistente a los desinfectantes y productos de limpieza.
- > Acceso por la parte inferior de la luminaria.

**QUICK INFO**

**GENERAL**

Recessed  
 IP54 (Optic)  
 IP20  
 IK09  
 850°C  
 Class I  
 Ta= -20°C +35°C

**OPTIC**

Opal Polycarbonate

**LED**

Efficacy up to 193 lm/W  
 3000 K, 4000 K, 5000K  
 CRI >80, CRI >90  
 Lifetime 72 000 H  
 L80/B10 @Tc=85°C

**ELECTRICAL SYSTEM**

230V/50Hz  
 ON/OFF, DALI

**FINISHING**

RAL 9003 Matt White

**OPTIONS**

**ELECTRICAL SYSTEM**

DSI, DIM 1-10V

**FINISHING**

Antibacterial Coating  
 Stainless Steel 304/316  
 Other Colours

**EMERGENCY**

1 Hour, 3 Hours  
 DALI 1 Hour, 3 Hours

**ASEPTIC REGULAR RECESSED**

**OPAL DIFFUSER**

CRI >80

bxc (mm)	Output (lm)	System (W)	ON/OFF	DALI
<b>3000 K</b>				
595x595	3266	32	33.12.700.00000	33.12.700.00012
	4471	47	33.12.700.00001	33.12.700.00013
295x1195	6386	57	33.12.700.00002	33.12.700.00014
	8487	80	33.12.700.00003	33.12.700.00015
295x1495	7982	72	33.12.700.00004	33.12.700.00016
	10609	100	33.12.700.00005	33.12.700.00017
<b>4000 K</b>				
595x595	3522	32	33.12.700.00048	33.12.700.00060
	4818	47	33.12.700.00049	33.12.700.00061
295x1195	6682	57	33.12.700.00050	33.12.700.00062
	8881	80	33.12.700.00051	33.12.700.00063
295x1495	8353	72	33.12.700.00052	33.12.700.00064
	11101	100	33.12.700.00053	33.12.700.00065
<b>5000 K</b>				
595x595	3522	32	33.12.700.00096	33.12.700.00108
	4818	47	33.12.700.00097	33.12.700.00109
295x1195	6682	57	33.12.700.00098	33.12.700.00110
	8881	80	33.12.700.00099	33.12.700.00111
295x1495	8353	72	33.12.700.00100	33.12.700.00112
	11101	100	33.12.700.00101	33.12.700.00113

CRI >90

bxc (mm)	Output (lm)	System (W)	ON/OFF	DALI
<b>3000 K</b>				
595x595	2638	27	33.12.700.00024	33.12.700.00036
	3814	40	33.12.700.00025	33.12.700.00037
295x1195	5507	58	33.12.700.00026	33.12.700.00038
	7316	80	33.12.700.00027	33.12.700.00039
295x1495	6883	72	33.12.700.00028	33.12.700.00040
	9145	100	33.12.700.00029	33.12.700.00041
<b>4000 K</b>				
595x595	2816	27	33.12.700.00072	33.12.700.00084
	4073	40	33.12.700.00073	33.12.700.00085
295x1195	5748	58	33.12.700.00074	33.12.700.00086
	7637	80	33.12.700.00075	33.12.700.00087
295x1495	7184	72	33.12.700.00076	33.12.700.00088
	9546	100	33.12.700.00077	33.12.700.00089

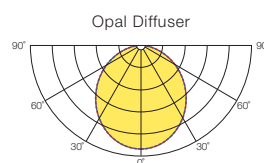
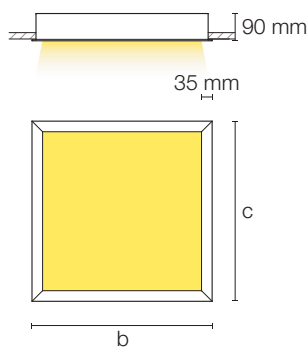

**QUICK INFO**

**GENERAL**

Recessed  
 IP54 (Optic)  
 IP20  
 IK09  
 960°C  
 Class I  
 Ta= -20°C +35°C

**OPTIC**

Micro Prismatic PMMA (UGR <19)  
 + Clear Tempered Glass

**LED**

Efficacy up to 193 lm/W  
 3000 K, 4000 K, 5000K  
 CRI >80, CRI >90  
 Lifetime 72 000 H  
 L80/B10 @Tc=85°C

**ELETRICAL SYSTEM**

230V/50Hz  
 ON/OFF, DALI

**FINISHING**

RAL 9003 Matt White

**OPTIONS**

**ELECTRICAL SYSTEM**

DSI, DIM 1-10V

**FINISHING**

Antibacterial Coating  
 Stainless Steel 304/316  
 Other Colours

**EMERGENCY**

1 Hour, 3 Hours  
 DALI 1 Hour, 3 Hours

**ASEPTIC REGULAR RECESSED**

**MICRO PRISMATIC DIFFUSER (UGR <19) + CLEAR GLASS**

CRI >80

bxc (mm)	Output (lm)	System (W)	ON/OFF	DALI
<b>3000 K</b>				
595x595	3563	32	33.12.700.00006	33.12.700.00018
	4877	47	33.12.700.00007	33.12.700.00019
295x1195	7090	57	33.12.700.00008	33.12.700.00020
	9424	80	33.12.700.00009	33.12.700.00021
295x1495	8863	72	33.12.700.00010	33.12.700.00022
	11780	100	33.12.700.00011	33.12.700.00023
<b>4000 K</b>				
595x595	3841	32	33.12.700.00054	33.12.700.00066
	5256	47	33.12.700.00055	33.12.700.00067
295x1195	7420	57	33.12.700.00056	33.12.700.00068
	9861	80	33.12.700.00057	33.12.700.00069
295x1495	9275	72	33.12.700.00058	33.12.700.00070
	12326	100	33.12.700.00059	33.12.700.00071
<b>5000 K</b>				
595x595	3841	32	33.12.700.00102	33.12.700.00114
	5256	47	33.12.700.00103	33.12.700.00115
295x1195	7420	57	33.12.700.00104	33.12.700.00116
	9861	80	33.12.700.00105	33.12.700.00117
295x1495	9275	72	33.12.700.00106	33.12.700.00118
	12326	100	33.12.700.00107	33.12.700.00119

CRI >90

bxc (mm)	Output (lm)	System (W)	ON/OFF	DALI
<b>3000 K</b>				
595x595	2877	27	33.12.700.00030	33.12.700.00042
	4161	40	33.12.700.00031	33.12.700.00043
295x1195	6115	58	33.12.700.00032	33.12.700.00044
	8124	80	33.12.700.00033	33.12.700.00045
295x1495	7643	72	33.12.700.00034	33.12.700.00046
	10155	100	33.12.700.00035	33.12.700.00047
<b>4000 K</b>				
595x595	3072	27	33.12.700.00078	33.12.700.00090
	4443	40	33.12.700.00079	33.12.700.00091
295x1195	6382	58	33.12.700.00080	33.12.700.00092
	8480	80	33.12.700.00081	33.12.700.00093
295x1495	7977	72	33.12.700.00082	33.12.700.00094
	10600	100	33.12.700.00083	33.12.700.00095

**OPTIONS**

**SUCTION CUP**



	DIMENSION	COD
Rubber Suction Cup (to assist in diffuser removal)	Ø80 mm	35.12.001.08.90

Micro Prismatic Diffuser - UGR<19

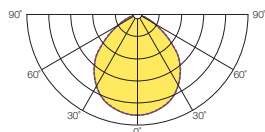



# ASEPTIC WALK-ON RECESSED

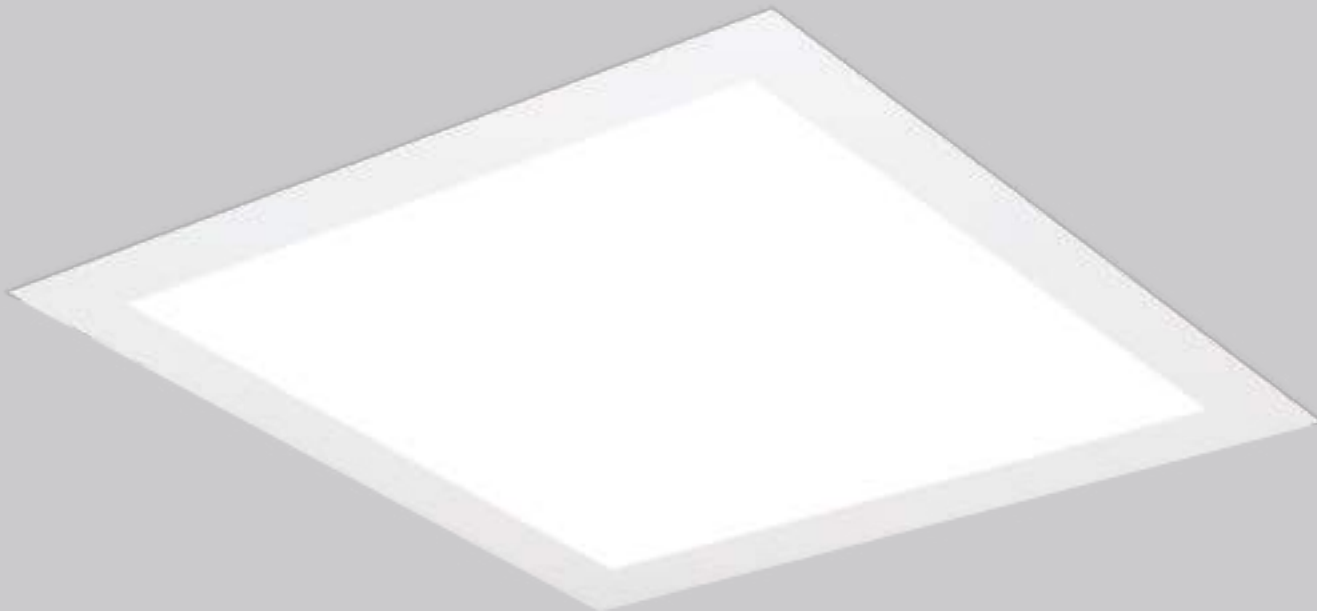

## PT

- > Luminária de encastrar com porta de inspeção superior para acesso pelo vão do teto.
- > Luminária IP65/IP54 com transições suaves nas superfícies visíveis para maior proteção contra depósitos e facilidade de limpeza e desinfeção.
- > Conforme as normas EN 60598-2-25 (Luminárias para uso em áreas clínicas) e EN 62471 (Segurança fotobiológica).
- > Difusor PMMA Microprismático para controlo do encandeamento (UGR <19) ou difusor Policarbonato Opal, ambos protegidos por vidro temperado transparente.
- > Corpo em chapa de aço com revestimento a epoxy-poliéster resistente a desinfetantes e produtos de limpeza.
- > Acesso pela parte superior da luminária.

## ES

- > Luminaria de empotrar con puerta de inspección superior para acceso por el vano del techo.
- > Luminaria IP65/IP54 con transiciones suaves en las superficies visibles para mayor protección contra depósitos y facilidad de limpieza y desinfección.
- > De acuerdo a las normativas EN 60598-2-25 (Luminarias para uso en áreas clínicas) e EN 62471 (Seguridad fotobiológica).
- > Difusor PMMA Microprismático para control del deslumbramiento (UGR <19) o difusor Policarbonato Opal, ambos protegidos por vidrio templado transparente.
- > Cuerpo de chapa de acero con recubrimiento epoxi-poliéster resistente a los desinfectantes y productos de limpieza.
- > Acceso por la parte superior de la luminaria.



**QUICK INFO**

**GENERAL**

Recessed  
 IP65 (Optic)  
 IP54  
 IK09  
 960°C  
 Class I  
 Ta= -20°C +35°C

**OPTIC**

Opal Polycarbonate  
 + Clear Tempered Glass

**LED**

Efficacy up to 164 lm/W  
 4000 K, 6500K  
 CRI >80  
 Lifetime 60 000 H  
 L80/B10 @Tc=65°C

**ELETRICAL SYSTEM**

230V/50Hz  
 ON/OFF, DALI

**FINISHING**

RAL 9003 Matt White

CRI >80

**ASEPTIC WALK-ON RECESSED  
 OPAL DIFFUSER + CLEAR GLASS**

bxc (mm)	Output (lm)	System (W)	ON/OFF	DALI
<b>4000 K</b>				
600x600	3240	32	33.12.715.00000	33.12.715.00008
	4084	42	33.12.715.00001	33.12.715.00009
600x1200	6340	64	33.12.715.00002	33.12.715.00010
	7993	84	33.12.715.00003	33.12.715.00011
<b>6500 K</b>				
600x600	3208	32	33.12.715.00016	33.12.715.00024
	4046	42	33.12.715.00017	33.12.715.00025
600x1200	6279	64	33.12.715.00018	33.12.715.00026
	7918	84	33.12.715.00019	33.12.715.00027

**OPTIONS**

**LED**

5000K  
 CRI >90

**ELECTRICAL SYSTEM**

DSI, DIM 1-10V

**FINISHING**

Antibacterial Coating  
 Stainless Steel 304/316  
 Other Colours

**EMERGENCY**

1 Hour, 3 Hours  
 DALI 1 Hour, 3 Hours

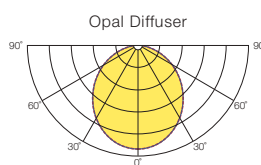
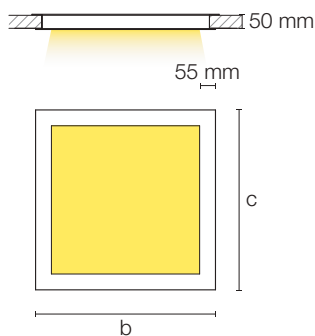

**WALK-ON PROTECTION**

SAFEGUARDS PERSONNEL  
 WORKING ABOVE THE CEILING

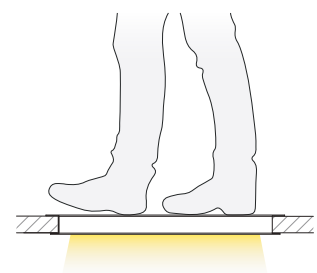

**QUICK INFO**

**GENERAL**

Recessed  
 IP65 (Optic)  
 IP54  
 IK09  
 960°C  
 Class I  
 Ta= -20°C +35°C

**OPTIC**

Micro Prismatic PMMA (UGR <19)  
 + Clear Tempered Glass

**LED**

Efficacy up to 164 lm/W  
 4000 K, 6500K  
 CRI >80  
 Lifetime 60 000 H  
 L80/B10 @TC=65°C

**ELETRICAL SYSTEM**

230V/50Hz  
 ON/OFF, DALI

**FINISHING**

RAL 9003 Matt White

CRI >80

**ASEPTIC WALK-ON RECESSED**

**MICRO PRISMATIC DIFFUSER (UGR <19) + CLEAR GLASS**

bxc (mm)	Output (lm)	System (W)	ON/OFF	DALI
<b>4000 K</b>				
600x600	3841	32	33.12.715.00004	33.12.715.00012
	4843	42	33.12.715.00005	33.12.715.00013
600x1200	7040	64	33.12.715.00006	33.12.715.00014
	8875	84	33.12.715.00007	33.12.715.00015
<b>6500 K</b>				
600x600	3804	32	33.12.715.00020	33.12.715.00028
	4797	42	33.12.715.00021	33.12.715.00029
600x1200	6972	64	33.12.715.00022	33.12.715.00030
	8792	84	33.12.715.00023	33.12.715.00031

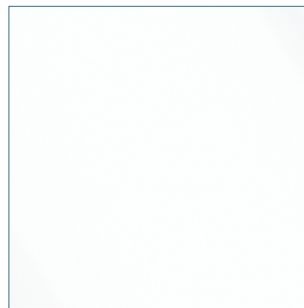

> Opal Diffuser



> Micro Prismatic Diffuser

**OPTIONS**

**LED**

5000K  
 CRI >90

**ELECTRICAL SYSTEM**

DSI, DIM 1-10V

**FINISHING**

Antibacterial Coating  
 Stainless Steel 304/316  
 Other Colours

**EMERGENCY**

1 Hour, 3 Hours  
 DALI 1 Hour, 3 Hours

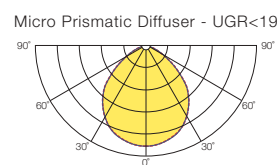
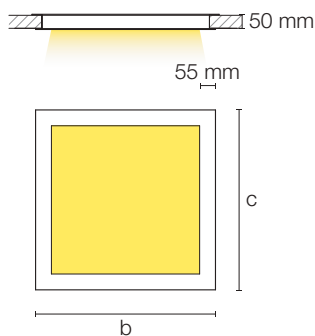



**TUPOLI 70**  
SUSPENDED





# TUPOLI 70 IP65, IP66

## SUSPENDED



### PT

- > Luminária tubular com elevado grau de proteção.
- > De aplicação suspensa por cabos de aço inox com ajuste rápido da altura.
- > Índice de proteção IP65 ou IP66 e resistência a impactos IK10.
- > Difusor cilíndrico em Policarbonato Opal.
- > Refletor interno em alumínio para maior desempenho da luminária.
- > Topo em Policarbonato com buçim para garantir o IP da luminária.

### ES

- > Luminaria tubular con alto grado de protección.
- > Aplicación suspendida por cables de acero inoxidable con regulación de la altura.
- > Grado de protección IP65 o IP66 y resistencia a los impactos IK10.
- > Difusor cilíndrico en Policarbonato Opal.
- > Reflector interno en aluminio para aumentar el rendimiento de la luminaria.
- > Tapa final en Policarbonato con prensa estopas para garantizar el IP de la luminaria.

**QUICK INFO**

**GENERAL**

Suspended  
 IP65  
 IK10  
 850°C  
 Class I  
 Ta= -20°C +35°C

**OPTIC**

Opal Polycarbonate

**LED**

Efficacy up to 196 lm/W  
 3000 K, 4000 K  
 CRI >80  
 Lifetime 60 000 H  
 L80/B10 @Tc=65°C

**ELETRICAL SYSTEM**

230V/50Hz  
 ON/OFF, DALI

**OPTIONS**

**GENERAL**

Class II

**LED**

2700 K, 5000 K, 6500 K  
 Tunable White, RGB, RGBW  
 CRI >90

**ELECTRICAL SYSTEM**

DSI, DIM 1-10V, Phase-cut

**CONTROL SYSTEM**

Bluetooth

**SENSORS**

Motion  
 Ambient Light  
 Motion & Ambient Light

**TUPOLI 70 SUSPENDED  
 OPAL DIFFUSER**

**IP65**

c (mm)	Output (lm)	System (W)	ON/OFF	DALI
<b>3000 K</b>				
931	1965	15	33.49.005.08.14	33.49.005.08.15
	2836	23	33.49.003.08.68	33.49.003.08.77
	4796	38	33.49.007.08.12	33.49.007.08.15
1212	2620	19	33.49.003.08.69	33.49.003.08.78
	3781	30	33.49.003.08.70	33.49.003.08.79
	6395	51	33.49.007.08.13	33.49.007.08.16
1493	3275	24	33.49.003.08.71	33.49.003.08.80
	4726	38	33.49.003.08.72	33.49.003.08.81
	7994	63	33.49.007.08.14	33.49.007.08.17
<b>4000 K</b>				
931	2058	15	33.49.005.08.16	33.49.005.08.17
	2971	23	33.49.003.08.86	33.49.003.08.99
	5026	38	33.49.007.08.18	33.49.007.08.21
1212	2744	19	33.49.003.08.87	33.49.004.08.00
	3961	30	33.49.003.08.88	33.49.004.08.01
	6701	51	33.49.007.08.19	33.49.007.08.22
1493	3430	24	33.49.003.08.89	33.49.004.08.02
	4951	38	33.49.003.08.90	33.49.004.08.03
	8377	63	33.49.007.08.20	33.49.007.08.23

> Fluorescent lamp versions also available – product data at [www.climarlighting.com](http://www.climarlighting.com) – or by direct request to the factory.

**COMPONENTS**

**SUSPENSION SYSTEM (2pcs)**



TYPE	1 m	3 m	5 m
Matt White + Stainless Steel Cable	35.49.003.01.72	35.49.003.01.73	35.49.003.01.74

**OPTIONS**

**EMERGENCY (EM) - SELF-TEST INTEGRATED**



ON/OFF	COD
EM 1H 3W	35.00.003.01.23*
EM 3H 3W	35.00.003.01.24**
DALI	COD
EM 1H 5,4W DALI	35.00.004.01.54*
EM 3H 5,4W DALI	35.00.004.01.55**

\* Applies to lengths equal to or greater than 1212 mm. \*\* Applies to lengths equal to or greater than 1493 mm.  
 > On request – External Emergency. Box dimensions: 45x120x360 mm.

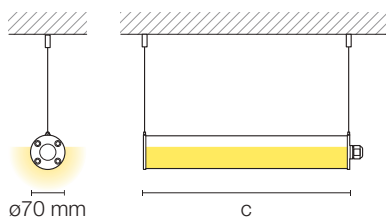
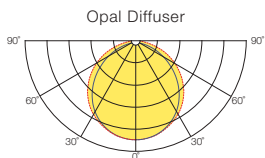

**QUICK INFO**

**GENERAL**

Suspended  
 IP66  
 IK10  
 850°C  
 Class I  
 Ta= -20°C +35°C

**OPTIC**

Opal Polycarbonate

**LED**

Efficacy up to 196 lm/W  
 3000 K, 4000 K  
 CRI >80  
 Lifetime 60 000 H  
 L80/B10 @Tc=65°C

**ELETRICAL SYSTEM**

230V/50Hz  
 ON/OFF, DALI

**OPTIONS**

**GENERAL**

Class II

**LED**

2700 K, 5000 K, 6500 K  
 Tunable White, RGB, RGBW  
 CRI >90

**ELECTRICAL SYSTEM**

DSI, DIM 1-10V, Phase-cut

**CONTROL SYSTEM**

Bluetooth

**SENSORS**

Motion  
 Ambient Light  
 Motion & Ambient Light

**TUPOLI 70 SUSPENDED  
 OPAL DIFFUSER**

**IP66**

c (mm)	Output (lm)	System (W)	ON/OFF	DALI
<b>3000 K</b>				
931	1965	15	33.49.006.08.71	33.49.006.08.28
	2836	23	33.49.006.08.72	33.49.006.08.29
	4796	38	33.49.007.08.24	33.49.007.08.27
1212	2620	19	33.49.006.08.73	33.49.006.08.30
	3781	30	33.49.006.08.25	33.49.006.08.31
	6395	51	33.49.007.08.25	33.49.007.08.28
1493	3275	24	33.49.006.08.26	33.49.006.08.32
	4726	38	33.49.006.08.27	33.49.006.08.33
	7994	63	33.49.007.08.26	33.49.007.08.29
<b>4000 K</b>				
931	2058	15	33.49.006.08.34	33.49.006.08.40
	2971	23	33.49.006.08.35	33.49.006.08.41
	5026	38	33.49.007.08.30	33.49.007.08.33
1212	2744	19	33.49.006.08.36	33.49.006.08.42
	3961	30	33.49.006.08.37	33.49.006.08.43
	6701	51	33.49.007.08.31	33.49.007.08.34
1493	3430	24	33.49.006.08.38	33.49.006.08.44
	4951	38	33.49.006.08.39	33.49.006.08.45
	8377	63	33.49.007.08.32	33.49.007.08.35

> Fluorescent lamp versions also available – product data at [www.climarlighting.com](http://www.climarlighting.com) – or by direct request to the factory.

**COMPONENTS**

**SUSPENSION SYSTEM (2pcs)**



TYPE	1 m	3 m	5 m
Matt White + Stainless Steel Cable	35.49.003.01.72	35.49.003.01.73	35.49.003.01.74

**OPTIONS**

**EMERGENCY (EM) - SELF-TEST INTEGRATED**



ON/OFF	COD
EM 1H 3W	35.00.003.01.23*
EM 3H 3W	35.00.003.01.24**

DALI	COD
EM 1H 5,4W DALI	35.00.004.01.54*
EM 3H 5,4W DALI	35.00.004.01.55**

\* Applies to lengths equal to or greater than 1212 mm. \*\* Applies to lengths equal to or greater than 1493 mm.  
 > On request – External Emergency. Box dimensions: 45x120x360 mm.

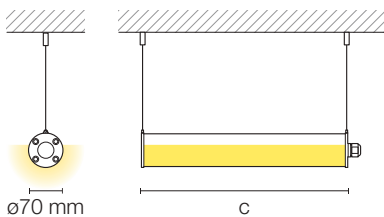
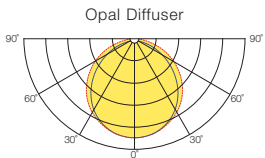





# TUPOLI 70

IP65, IP66

## SURFACE



### PT

- > Luminária tubular com elevado grau de proteção.
- > De aplicação saliente no teto ou na parede com peças de fixação em policarbonato ou inox.
- > Índice de proteção IP65 ou IP66 e resistência a impactos IK10.
- > Difusor cilíndrico em Policarbonato Opal.
- > Refletor interno em alumínio para maior desempenho da luminária.
- > Topo em Policarbonato com buçim para garantir o IP da luminária.

### ES

- > Luminaria tubular con alto grado de protección.
- > Aplicación adosada a techo o pared por soportes de fijación en policarbonato o acero inoxidable.
- > Grado de protección IP65 o IP66 y resistencia a los impactos IK10.
- > Difusor cilíndrico en Policarbonato Opal.
- > Reflector interno en aluminio para aumentar el rendimiento de la luminaria.
- > Tapa final en Policarbonato con prensa estopas para garantizar el IP de la luminaria.

**QUICK INFO**

**GENERAL**

Surface  
 IP65  
 IK10  
 850°C  
 Class I  
 Ta= -20°C +35°C

**OPTIC**

Opal Polycarbonate

**LED**

Efficacy up to 196 lm/W  
 3000 K, 4000 K  
 CRI >80  
 Lifetime 60 000 H  
 L80/B10 @Tc=65°C

**ELETRICAL SYSTEM**

230V/50Hz  
 ON/OFF, DALI

**OPTIONS**

**GENERAL**

Class II

**LED**

2700 K, 5000 K, 6500 K  
 Tunable White, RGB, RGBW  
 CRI >90

**ELECTRICAL SYSTEM**

DSI, DIM 1-10V, Phase-cut

**CONTROL SYSTEM**

Bluetooth

**SENSORS**

Motion  
 Ambient Light  
 Motion & Ambient Light

**TUPOLI 70 SURFACE  
 OPAL DIFFUSER**

**IP65**

c (mm)	Output (lm)	System (W)	ON/OFF	DALI
<b>3000 K</b>				
931	1965	15	33.49.003.08.95	33.49.003.08.96
	2836	23	33.49.002.08.54	33.49.002.08.63
	4796	38	33.49.007.08.36	33.49.007.08.41
1212	2620	19	33.49.002.08.55	33.49.002.08.64
	3781	30	33.49.002.08.56	33.49.002.08.65
	6395	51	33.49.007.08.37	33.49.007.08.42
1493	3275	24	33.49.002.08.57	33.49.002.08.66
	4726	38	33.49.002.08.58	33.49.002.08.67
	7994	63	33.49.007.08.38	33.49.007.08.43
2336	5239	39	33.49.002.08.59	33.49.002.08.68
	7562	60	33.49.002.08.60	33.49.002.08.69
	12790	101	33.49.007.08.39	33.49.007.08.44
2898	6549	49	33.49.002.08.61	33.49.002.08.70
	9452	75	33.49.002.08.62	33.49.002.08.71
	15988	127	33.49.007.08.40	33.49.007.08.45
<b>4000 K</b>				
931	2058	15	33.49.003.08.97	33.49.003.08.98
	2971	23	33.49.002.08.72	33.49.002.08.81
	5026	38	33.49.007.08.46	33.49.007.08.51
1212	2744	19	33.49.002.08.73	33.49.002.08.82
	3961	30	33.49.002.08.74	33.49.002.08.83
	6701	51	33.49.007.08.47	33.49.007.08.52
1493	3430	24	33.49.002.08.75	33.49.002.08.84
	4951	38	33.49.002.08.76	33.49.002.08.85
	8377	63	33.49.007.08.48	33.49.007.08.53
2336	5489	39	33.49.002.08.77	33.49.002.08.86
	7921	60	33.49.002.08.78	33.49.002.08.87
	13403	101	33.49.007.08.49	33.49.007.08.54
2898	6861	49	33.49.002.08.79	33.49.002.08.88
	9902	75	33.49.002.08.80	33.49.002.08.89
	16753	127	33.49.007.08.50	33.49.007.08.55

> Fluorescent lamp versions also available – product data at [www.climarlighting.com](http://www.climarlighting.com) – or by direct request to the factory.

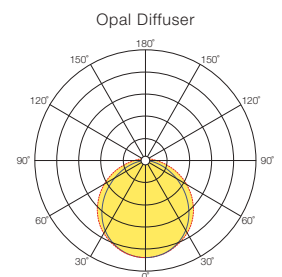
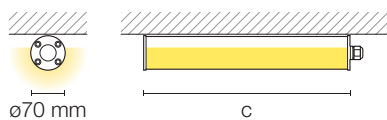

**QUICK INFO**

**GENERAL**

Surface  
 IP66  
 IK10  
 850°C  
 Class I  
 Ta= -20°C +35°C

**OPTIC**

Opal Polycarbonate

**LED**

Efficacy up to 196 lm/W  
 3000 K, 4000 K  
 CRI >80  
 Lifetime 60 000 H  
 L80/B10 @Tc=65°C

**ELETRICAL SYSTEM**

230V/50Hz  
 ON/OFF, DALI

**OPTIONS**

**GENERAL**

Class II

**LED**

2700 K, 5000 K, 6500 K  
 Tunable White, RGB, RGBW  
 CRI >90

**ELECTRICAL SYSTEM**

DSI, DIM 1-10V, Phase-cut

**CONTROL SYSTEM**

Bluetooth

**SENSORS**

Motion  
 Ambient Light  
 Motion & Ambient Light

**TUPOLI 70 SURFACE  
 OPAL DIFFUSER**

**IP66**

c (mm)	Output (lm)	System (W)	ON/OFF	DALI
<b>3000 K</b>				
931	1965	15	33.49.005.08.85	33.49.005.08.95
	2836	23	33.49.005.08.86	33.49.005.08.96
	4796	38	33.49.007.08.56	33.49.007.08.61
1212	2620	19	33.49.005.08.87	33.49.005.08.97
	3781	30	33.49.005.08.88	33.49.005.08.98
	6395	51	33.49.007.08.57	33.49.007.08.62
1493	3275	24	33.49.005.08.89	33.49.005.08.99
	4726	38	33.49.005.08.90	33.49.006.08.00
	7994	63	33.49.007.08.58	33.49.007.08.63
2336	5239	39	33.49.005.08.91	33.49.006.08.01
	7562	60	33.49.005.08.92	33.49.006.08.02
	12790	101	33.49.007.08.59	33.49.007.08.64
2898	6549	49	33.49.005.08.93	33.49.006.08.03
	9452	75	33.49.005.08.94	33.49.006.08.04
	15988	127	33.49.007.08.60	33.49.007.08.65
<b>4000 K</b>				
931	2058	15	33.49.006.08.05	33.49.006.08.15
	2971	23	33.49.006.08.06	33.49.006.08.16
	5026	38	33.49.007.08.66	33.49.007.08.71
1212	2744	19	33.49.006.08.07	33.49.006.08.17
	3961	30	33.49.006.08.08	33.49.006.08.18
	6701	51	33.49.007.08.67	33.49.007.08.72
1493	3430	24	33.49.006.08.09	33.49.006.08.19
	4951	38	33.49.006.08.10	33.49.006.08.20
	8377	63	33.49.007.08.68	33.49.007.08.73
2336	5489	39	33.49.006.08.11	33.49.006.08.21
	7921	60	33.49.006.08.12	33.49.006.08.22
	13403	101	33.49.007.08.69	33.49.007.08.74
2898	6861	49	33.49.006.08.13	33.49.006.08.23
	9902	75	33.49.006.08.14	33.49.006.08.24
	16753	127	33.49.007.08.70	33.49.007.08.75

> Fluorescent lamp versions also available – product data at [www.climarlighting.com](http://www.climarlighting.com) – or by direct request to the factory.

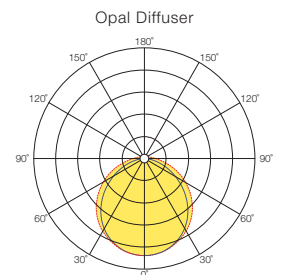
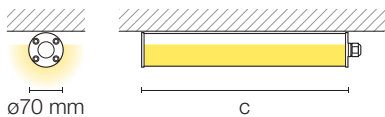

# TUPOLI 70

## SURFACE

### COMPONENTS



1

#### MOUNTING SYSTEM (2pcs)

TYPE	FIG	COD
Polycarbonate Mounting Brackets	1	35.49.003.01.46
Stainless Steel Mounting Brackets	2	35.49.003.01.47



2

### OPTIONS



#### EMERGENCY (EM) - SELF-TEST INTEGRATED

ON/OFF	COD
EM 1H 3W	35.00.003.01.23*
EM 3H 3W	35.00.003.01.24**

DALI	COD
EM 1H 5,4W DALI	35.00.004.01.54*
EM 3H 5,4W DALI	35.00.004.01.55**

\* Applies to lengths equal to or greater than 1212 mm. \*\* Applies to lengths equal to or greater than 1493 mm.  
 > On request - External Emergency. Box dimensions: 45x120x360 mm.

### DETAILS

#### 1 > POLYCARBONATE MOUNTING BRACKETS



#### 2 > STAINLESS STEEL MOUNTING BRACKETS



ATE  
WATERPROOF





# ATE IP65, IP66

## SURFACE



### PT

- > Luminária estanque para locais com condições adversas de humidade.
- > Índice de proteção IP65 e IP66 com resistência a impactos IK08.
- > Acessórios incluídos para aplicação suspensa ou saliente.
- > Patilhas de fecho do difusor em aço inox (IP66) ou policarbonato (IP65) para garantir o índice de proteção e a facilidade de instalação.
- > Difusor Policarbonato Opal para iluminação homogénea, difusa e eficiente.
- > Em versões de formato largo (140 mm) e estreito (90 mm).
- > Corpo em policarbonato injetado.

### ES

- > Luminaria estanca para locales húmedos y zonas exteriores cubiertas.
- > Grado de protección IP65 e IP66 con resistencia a los impactos IK08.
- > Accesorios incluidos para aplicación suspendida o en superficie.
- > Clips de cierre del difusor en acero inoxidable (IP66) o en policarbonato (IP65) para garantizar el grado de protección y la facilidad de instalación.
- > Difusor Policarbonato Opal resistente al impacto.
- > En versiones de forma constructiva ancha (140 mm) y estrecha (90 mm).
- > Cuerpo inyectado en policarbonato.



**QUICK INFO**

**GENERAL**

Suspended / Surface  
 IP65  
 IK08  
 850°C  
 Class I  
 Ta= -20°C +35°C

**OPTIC**

Opal Polycarbonate

**LED**

Efficacy up to 174 lm/W  
 4000 K  
 CRI >80  
 Lifetime 72 000 H  
 L80/B10 @Tc=65°C

**ELETRICAL SYSTEM**

230V/50Hz  
 ON/OFF, DALI

**ATE 90 SURFACE**

**IP65**

c (mm)	Output (lm)	System (W)	ON/OFF	DALI
<b>4000 K</b>				
664	1568	12	33.91.000.08.01	33.91.000.08.12
1274	3136	24	33.91.000.08.02	33.91.000.08.07
1574	3911	30	33.91.000.08.03	33.91.000.08.08

**ATE 140 SURFACE**

**IP65**

c (mm)	Output (lm)	System (W)	ON/OFF	DALI
<b>4000 K</b>				
664	3047	24	33.91.000.08.04	33.91.000.08.09
1274	6095	47	33.91.000.08.05	33.91.000.08.10
1574	7602	59	33.91.000.08.06	33.91.000.08.11

> Fluorescent lamp versions also available – product data at [www.climarlighting.com](http://www.climarlighting.com) – or by direct request to the factory.

**OPTIONS**

**LED**

2700 K, 3000 K, 5000 K, 6500 K

**ELECTRICAL SYSTEM**

DSI, DIM 1-10V

**EMERGENCY**

DALI 1 Hour, 3 Hours

**SENSORS**

Motion  
 Ambient Light  
 Motion & Ambient Light

**OPTIONS**

**EMERGENCY (EM) - SELF-TEST INTEGRATED**



**ON/OFF**

ON/OFF	COD
EM 1H 3W	35.00.003.01.66
EM 3H 3W	35.00.003.01.67

**DETAILS**

- 1 > Polycarbonate diffuser clips for IP65 protection.
- 2 > Accessories included for all mounting options (Suspended, Surface).

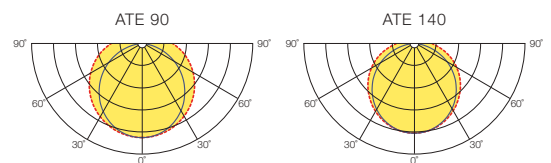
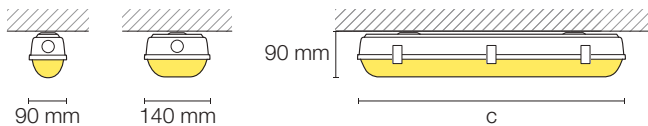
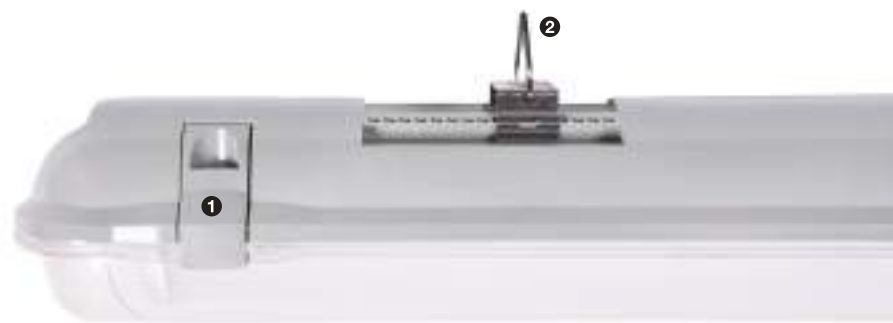

**QUICK INFO**

**GENERAL**

Suspended / Surface  
 IP66  
 IK08  
 850°C  
 Class I  
 Ta= -20°C +35°C

**OPTIC**

Opal Polycarbonate

**LED**

Efficacy up to 174 lm/W  
 4000 K  
 CRI >80  
 Lifetime 72 000 H  
 L80/B10 @Tc=65°C

**ELETRICAL SYSTEM**

230V/50Hz  
 ON/OFF, DALI

**OPTIONS**

**LED**

2700 K, 3000 K, 5000 K, 6500 K

**ELECTRICAL SYSTEM**

DSI, DIM 1-10V

**EMERGENCY**

DALI 1 Hour, 3 Hours

**SENSORS**

Motion  
 Ambient Light  
 Motion & Ambient Light

**ATE 90 SURFACE**

**IP66**

c (mm)	Output (lm)	System (W)	ON/OFF	DALI
<b>4000 K</b>				
664	1568	12	33.91.000.08.28	33.91.000.08.34
1274	3136	24	33.91.000.08.29	33.91.000.08.35
1574	3911	30	33.91.000.08.30	33.91.000.08.36

**ATE 140 SURFACE**

**IP66**

c (mm)	Output (lm)	System (W)	ON/OFF	DALI
<b>4000 K</b>				
664	3047	24	33.91.000.08.31	33.91.000.08.37
1274	6095	47	33.91.000.08.32	33.91.000.08.38
1574	7602	59	33.91.000.08.33	33.91.000.08.39

> Fluorescent lamp versions also available – product data at [www.climarlighting.com](http://www.climarlighting.com) – or by direct request to the factory.

**OPTIONS**

**EMERGENCY (EM) - SELF-TEST INTEGRATED**



**ON/OFF**

ON/OFF	COD
EM 1H 3W	35.00.003.01.66
EM 3H 3W	35.00.003.01.67

**DETAILS**

- 1 > Stainless steel diffuser clips for high protection (IP66).
- 2 > Accessories included for all mounting options (Suspended, Surface).

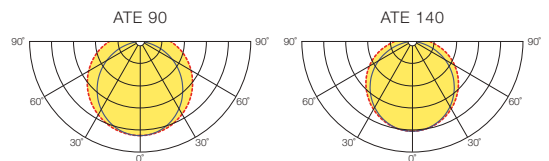
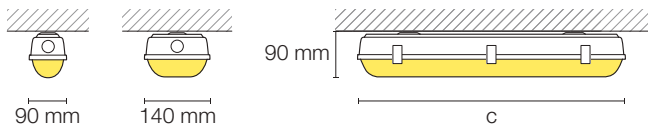
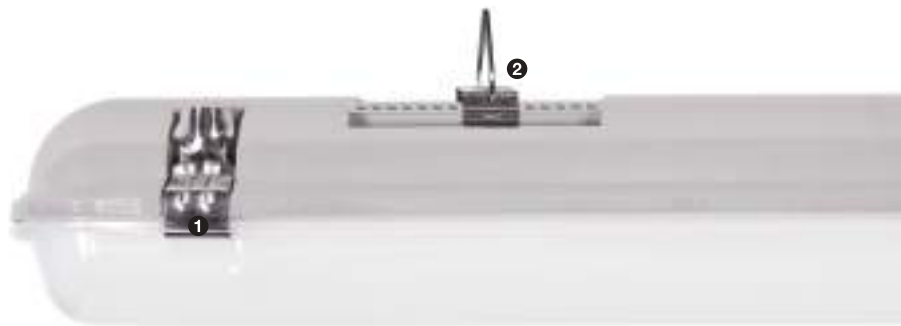



> ATE 90 IP65 SURFACE

**EDBAY**  
SUSPENDED





# EDBAY RO

## SUSPENDED



### PT

- > Luminária industrial compacta para iluminação interior na indústria, armazéns e pavilhões de exposição.
- > Indicado para substituição direta de luminárias com lâmpadas de descarga convencionais de 250 e 400 W.
- > Sistema ótico composto por lentes em policarbonato com duas opções de ângulo de abertura: 60° ou 90°.
- > Suspensão por cabo de aço inox.
- > Pré-cabado com cabo de 1000 mm para instalação rápida sem necessidade de abertura da luminária.
- > Corpo em alumínio com alhetas de refrigeração para otimização da gestão térmica.

### ES

- > Luminaria industrial compacta para iluminación interior en la industria, almacenes y pabellones feriales.
- > Indicado para la sustitución directa de luminarias para naves de gran altura con lámparas de descarga convencionales de 250 y 400 W.
- > Sistema óptico de lentes en policarbonato con dos opciones de ángulo de apertura: 60° o 90°.
- > Suspensión por cable de acero inoxidable.
- > Precableado con cable de 1000 mm para una instalación rápida sin necesidad de apertura de la luminaria.
- > Cuerpo en aluminio con aletas de refrigeración para una óptima gestión térmica.

EDBAY RO 2L

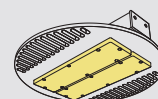

EDBAY RO 3L

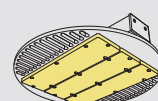

**QUICK INFO**

**GENERAL**

Suspended  
 IP65  
 IK07  
 850°C  
 Class I  
 Ta= -20°C +50°C

**OPTIC**

Polycarbonate Lens

**LED**

Efficacy up to 181 lm/W  
 4000 K, 5000K  
 CRI >85  
 Lifetime 60 000 H  
 L80/B10 @Tc=85°C

**ELETRICAL SYSTEM**

230V/50Hz  
 ON/OFF, DALI

**FINISHING**

RAL 9005 Matt Black

**OPTIONS**

**FINISHING**

 Other Colours

**EDBAY RO 2L**

Beam Angle (°)	Output (lm)	System (W)	ON/OFF	DALI
<b>4000 K</b>				
	6061	46	33.63.000.08.15	33.63.000.08.23
60°	11771	98	33.63.000.08.16	33.63.000.08.24
	17130	154	33.63.000.08.17	33.63.000.08.25
90°	6096	46	33.63.000.08.19	33.63.000.08.27
	11839	98	33.63.000.08.20	33.63.000.08.28
	17228	154	33.63.000.08.21	33.63.000.08.29
<b>5000 K</b>				
	6168	46	33.63.000.08.31	33.63.000.08.39
60°	11984	98	33.63.000.08.32	33.63.000.08.40
	17433	154	33.63.000.08.33	33.63.000.08.41
90°	6203	46	33.63.000.08.35	33.63.000.08.43
	12053	98	33.63.000.08.36	33.63.000.08.44
	17532	154	33.63.000.08.37	33.63.000.08.45

**EDBAY RO 3L**

Beam Angle (°)	Output (lm)	System (W)	ON/OFF	DALI
<b>4000 K</b>				
60°	25296	230	33.63.000.08.18	33.63.000.08.26
90°	25872	230	33.63.000.08.22	33.63.000.08.30
<b>5000 K</b>				
60°	25743	230	33.63.000.08.34	33.63.000.08.42
90°	26328	230	33.63.000.08.38	33.63.000.08.46

**COMPONENTS**

**SUSPENSION SYSTEM (2pcs)**

TYPE	3m	5m	10m
1 - Stainless Steel - Screw	35.63.000.08.03	35.63.000.08.04	35.63.000.08.05
2 - Stainless Steel - Tie	35.63.000.08.00	35.63.000.08.01	35.63.000.08.02

 GRIPPLE® Certified Suspension

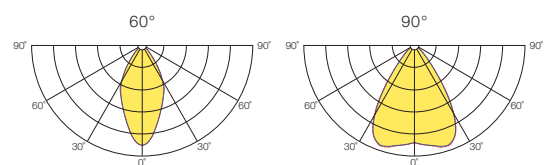
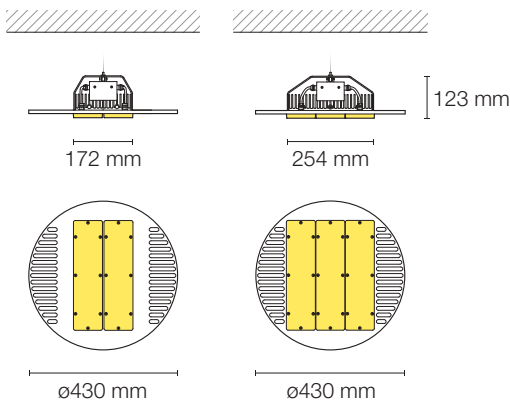
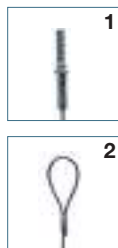

# EDBAY RT SUSPENDED



## PT

- > Luminária industrial compacta para iluminação interior na indústria, armazéns e pavilhões de exposição.
- > Indicado para substituição direta de luminárias com lâmpadas de descarga convencionais de 250 e 400 W.
- > Sistema ótico composto por lentes em policarbonato com duas opções de ângulo de abertura: 60° ou 90°.
- > Suspensão por cabo de aço inox.
- > Pré-cablado com cabo de 1000 mm para instalação rápida sem necessidade de abertura da luminária.
- > Corpo em alumínio com alhetas de refrigeração para otimização da gestão térmica.

## ES

- > Luminaria industrial compacta para iluminación interior en la industria, almacenes y pabellones feriales.
- > Indicado para la sustitución directa de luminarias para naves de gran altura con lámparas de descarga convencionales de 250 y 400 W.
- > Sistema óptico de lentes en policarbonato con dos opciones de ángulo de apertura: 60° o 90°.
- > Suspensión por cable de acero inoxidable.
- > Precableado con cable de 1000 mm para una instalación rápida sin necesidad de apertura de la luminaria.
- > Cuerpo en aluminio con aletas de refrigeración para una óptima gestión térmica.

EDBAY RT 2L

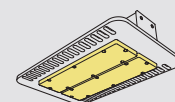

EDBAY RT 3L

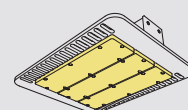



**QUICK INFO**

**GENERAL**

Suspended  
 IP65  
 IK07  
 850°C  
 Class I  
 Ta= -20°C +50°C

**OPTIC**

Polycarbonate Lens

**LED**

Efficacy up to 181 lm/W  
 4000 K, 5000K  
 CRI >85  
 Lifetime 60 000 H  
 L80/B10 @Tc=85°C

**ELETRICAL SYSTEM**

230V/50Hz  
 ON/OFF, DALI

**FINISHING**

RAL 9005 Matt Black

**OPTIONS**

**FINISHING**

 Other Colours

**EDBAY RT 2L**

Beam Angle (°)	Output (lm)	System (W)	ON/OFF	DALI
<b>4000 K</b>				
	6061	46	33.63.000.08.47	33.63.000.08.55
60°	11771	98	33.63.000.08.48	33.63.000.08.56
	17130	154	33.63.000.08.49	33.63.000.08.57
90°	6096	46	33.63.000.08.51	33.63.000.08.59
	11839	98	33.63.000.08.52	33.63.000.08.60
	17228	154	33.63.000.08.53	33.63.000.08.61
<b>5000 K</b>				
	5767	46	33.63.000.08.63	33.63.000.08.71
60°	11984	98	33.63.000.08.64	33.63.000.08.72
	17433	154	33.63.000.08.65	33.63.000.08.73
90°	5800	46	33.63.000.08.67	33.63.000.08.75
	12053	98	33.63.000.08.68	33.63.000.08.76
	17532	154	33.63.000.08.69	33.63.000.08.77

**EDBAY RT 3L**

Beam Angle (°)	Output (lm)	System (W)	ON/OFF	DALI
<b>4000 K</b>				
60°	25296	230	33.63.000.08.50	33.63.000.08.58
90°	25872	230	33.63.000.08.54	33.63.000.08.62
<b>5000 K</b>				
60°	25743	230	33.63.000.08.66	33.63.000.08.74
90°	26328	230	33.63.000.08.70	33.63.000.08.78

**COMPONENTS**

**SUSPENSION SYSTEM (2pcs)**



TYPE	3m	5m	10m
1 - Stainless Steel - Screw	35.63.000.08.03	35.63.000.08.04	35.63.000.08.05
2 - Stainless Steel - Tie	35.63.000.08.00	35.63.000.08.01	35.63.000.08.02

 GRIPPLE® Certified Suspension

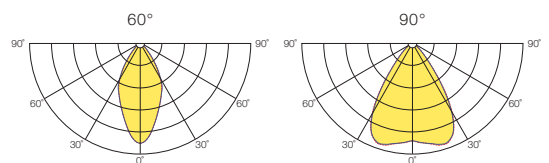
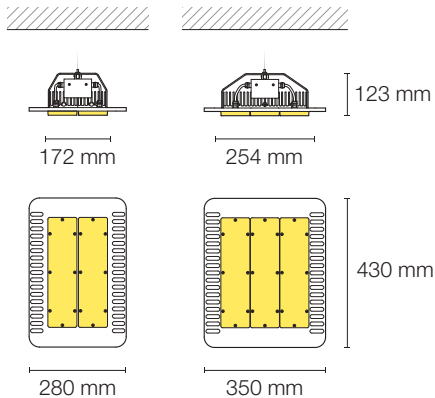

**FACTORY**  
SUSPENDED





> **FACTORY IP54** SUSPENDED

# FACTORY IP54 SUSPENDED



## PT

- > Luminária industrial LED com índice de proteção IP54.
- > Aplicação saliente no teto ou suspensa utilizando os acessórios opcionais.
- > Sistema óptico composto por lentes em PMMA.
- > Duas opções de ângulo de abertura: 60° ou 90°.
- > Corpo em chapa de aço com revestimento em poliéster.

## ES

- > Luminaria industrial LED con grado de protección IP54.
- > Apropriado para el montaje directo en el techo o suspendida utilizando los accesorios opcionales.
- > Sistema óptico de lentes en PMMA.
- > Dos opciones de ángulo de apertura: 60° o 90°.
- > Cuerpo de chapa de acero con recubrimiento de poliéster.

SUSPENDED



SURFACE



**QUICK INFO**

**GENERAL**

Suspended / Surface  
 IP54  
 IK07  
 650°C  
 Class I  
 Ta= -20°C +45°C

**OPTIC**

PMMA Lens

**LED**

Efficacy up to 184 lm/W  
 4000 K, 5000 K  
 CRI >85  
 Lifetime 54 000 H  
 L80/B10 @Tc=75°C

**ELETRICAL SYSTEM**

230V/50Hz  
 ON/OFF, DALI

**FINISHING**

RAL 9003 Matt White

**OPTIONS**

**LED**

3000 K, 6500 K

**ELECTRICAL SYSTEM**

DSI, DIM 1-10V

**FINISHING**

Other Colours

**EMERGENCY**

1 Hour, 3 Hours  
 DALI 1 Hour, 3 Hours

**SENSORS**

Motion  
 Ambient Light  
 Motion & Ambient Light

**FACTORY IP54 SUSPENDED**

**MATT WHITE FINISHING**

Beam Angle (°)	c (mm)	Output (lm)	System (W)	ON/OFF	DALI
<b>4000 K</b>					
60°	305	3844	25	33.63.002.08.00	33.63.002.08.16
		5246	36	33.63.002.08.01	33.63.002.08.17
	605	7689	51	33.63.002.08.02	33.63.002.08.18
		10492	73	33.63.002.08.03	33.63.002.08.19
	905	11533	76	33.63.002.08.04	33.63.002.08.20
		15739	109	33.63.002.08.05	33.63.002.08.21
1205	15378	102	33.63.002.08.06	33.63.002.08.22	
	20985	145	33.63.002.08.07	33.63.002.08.23	
90°	305	3843	25	33.63.002.08.08	33.63.002.08.24
		5245	36	33.63.002.08.09	33.63.002.08.25
	605	7687	51	33.63.002.08.10	33.63.002.08.26
		10490	73	33.63.002.08.11	33.63.002.08.27
	905	11530	76	33.63.002.08.12	33.63.002.08.28
		15735	109	33.63.002.08.13	33.63.002.08.29
1205	15374	102	33.63.002.08.14	33.63.002.08.30	
	20980	145	33.63.002.08.15	33.63.002.08.31	
<b>5000 K</b>					
60°	305	3900	25	33.63.002.08.64	33.63.002.08.80
		5330	36	33.63.002.08.65	33.63.002.08.81
	605	7800	51	33.63.002.08.66	33.63.002.08.82
		10659	73	33.63.002.08.67	33.63.002.08.83
	905	11700	76	33.63.002.08.68	33.63.002.08.84
		15989	109	33.63.002.08.69	33.63.002.08.85
1205	15600	102	33.63.002.08.70	33.63.002.08.86	
	21318	145	33.63.002.08.71	33.63.002.08.87	
90°	305	3899	25	33.63.002.08.72	33.63.002.08.88
		5328	36	33.63.002.08.73	33.63.002.08.89
	605	7798	51	33.63.002.08.74	33.63.002.08.90
		10656	73	33.63.002.08.75	33.63.002.08.91
	905	11697	76	33.63.002.08.76	33.63.002.08.92
		15984	109	33.63.002.08.77	33.63.002.08.93
1205	15596	102	33.63.002.08.78	33.63.002.08.94	
	21313	145	33.63.002.08.79	33.63.002.08.95	

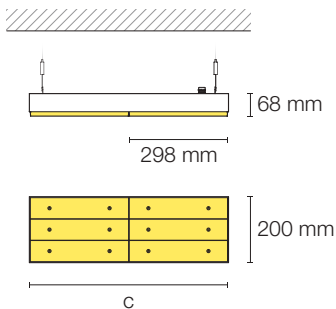

**QUICK INFO**

**GENERAL**

Suspended / Surface  
 IP54  
 IK07  
 650°C  
 Class I  
 Ta= -20°C +45°C

**OPTIC**

PMMA Lens

**LED**

Efficacy up to 184 lm/W  
 4000 K, 5000 K  
 CRI >85  
 Lifetime 54 000 H  
 L80/B10 @Tc=75°C

**ELETRICAL SYSTEM**

230V/50Hz  
 ON/OFF, DALI

**FINISHING**

RAL 9005 Matt Black

**OPTIONS**

**LED**

3000 K, 6500 K

**ELECTRICAL SYSTEM**

DSI, DIM 1-10V

**FINISHING**

Other Colours

**EMERGENCY**

1 Hour, 3 Hours  
 DALI 1 Hour, 3 Hours

**SENSORS**

Motion  
 Ambient Light  
 Motion & Ambient Light

**FACTORY IP54 SUSPENDED**

**MATT BLACK FINISHING**

Beam Angle (°)	c (mm)	Output (lm)	System (W)	ON/OFF	DALI
<b>4000 K</b>					
60°	305	3844	25	33.63.002.08.32	33.63.002.08.48
		5246	36	33.63.002.08.33	33.63.002.08.49
	605	7689	51	33.63.002.08.34	33.63.002.08.50
		10492	73	33.63.002.08.35	33.63.002.08.51
	905	11533	76	33.63.002.08.36	33.63.002.08.52
		15739	109	33.63.002.08.37	33.63.002.08.53
1205	15378	102	33.63.002.08.38	33.63.002.08.54	
	20985	145	33.63.002.08.39	33.63.002.08.55	
90°	305	3843	25	33.63.002.08.40	33.63.002.08.56
		5245	36	33.63.002.08.41	33.63.002.08.57
	605	7687	51	33.63.002.08.42	33.63.002.08.58
		10490	73	33.63.002.08.43	33.63.002.08.59
	905	11530	76	33.63.002.08.44	33.63.002.08.60
		15735	109	33.63.002.08.45	33.63.002.08.61
1205	15374	102	33.63.002.08.46	33.63.002.08.62	
	20980	145	33.63.002.08.47	33.63.002.08.63	
<b>5000 K</b>					
60°	305	3900	25	33.63.002.08.96	33.63.003.08.12
		5330	36	33.63.002.08.97	33.63.003.08.13
	605	7800	51	33.63.002.08.98	33.63.003.08.14
		10659	73	33.63.002.08.99	33.63.003.08.15
	905	11700	76	33.63.003.08.00	33.63.003.08.16
		15989	109	33.63.003.08.01	33.63.003.08.17
1205	15600	102	33.63.003.08.02	33.63.003.08.18	
	21318	145	33.63.003.08.03	33.63.003.08.19	
90°	305	3899	25	33.63.003.08.04	33.63.003.08.20
		5328	36	33.63.003.08.05	33.63.003.08.21
	605	7798	51	33.63.003.08.06	33.63.003.08.22
		10656	73	33.63.003.08.07	33.63.003.08.23
	905	11697	76	33.63.003.08.08	33.63.003.08.24
		15984	109	33.63.003.08.09	33.63.003.08.25
1205	15596	102	33.63.003.08.10	33.63.003.08.26	
	21313	145	33.63.003.08.11	33.63.003.08.27	

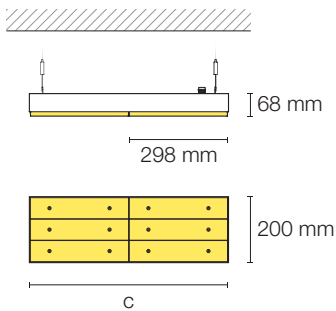

# FACTORY IP54 SUSPENDED

## COMPONENTS

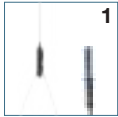

1

### SUSPENSION SYSTEM (2pcs)

TYPE	3m	5m	10m
1 - Stainless Steel Cable - Screw	35.63.002.08.03	35.63.002.08.04	35.63.002.08.05
2 - Stainless Steel Cable - Tie	35.63.002.08.00	35.63.002.08.01	35.63.002.08.02

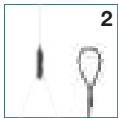

2

**GRIPPLE**® Certified Suspension



### SURFACE MOUNTING SYSTEM (2pcs)

TYPE	WHITE	BLACK
Surface Mounting System	35.63.002.08.06	35.63.002.08.07

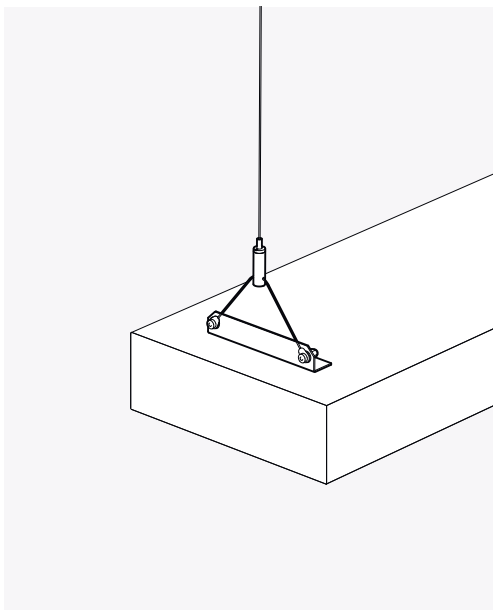

> Suspension Mounting System

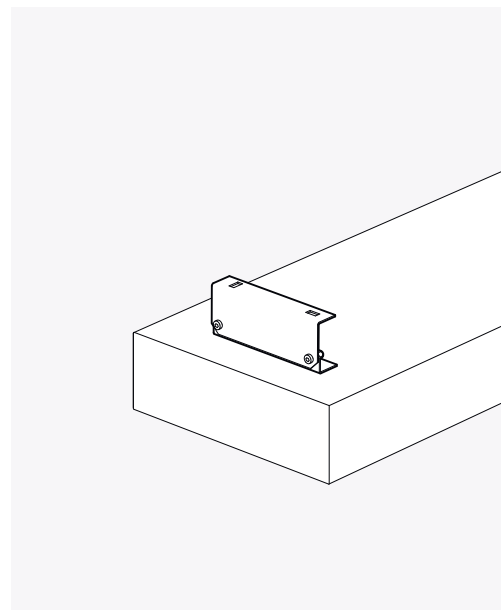

> Surface Mounting System

# FACTORY IP65

## SUSPENDED



### PT

- > Luminária industrial LED com índice de proteção IP65 para aplicação em interiores.
- > Aplicação saliente no teto ou suspensa utilizando os acessórios opcionais.
- > Sistema óptico composto por lentes em policarbonato com duas opções de ângulo de abertura (60° ou 90°) protegido por vidro temperado transparente.
- > Aro em alumínio sem parafusos visíveis.
- > Corpo em chapa de aço com revestimento em poliéster.

### ES

- > Luminaria industrial LED con grado de protección IP65 para aplicación en interiores.
- > Apropriado para el montaje directo en el techo o suspendida utilizando los accesorios opcionales.
- > Sistema óptico de lentes en policarbonato con dos opciones de ángulo de apertura (60° o 90°) protegido por vidrio templado transparente.
- > Marco frontal en aluminio sin tornillos visibles.
- > Cuerpo de chapa de acero con recubrimiento de poliéster.

SUSPENDED



SURFACE





## QUICK INFO

## GENERAL

Suspended / Surface

IP65

IK09

960°C

Class I

Ta= -20°C +45°C

## OPTIC

PMMA Lens

Clear Tempered Glass

## LED

Efficacy up to 176 lm/W

4000 K, 5000 K

CRI &gt;85

Lifetime 54 000 H

L80/B10 @Tc=75°C

## ELECTRICAL SYSTEM

230V/50Hz

ON/OFF, DALI

## FINISHING

RAL 9003 Matt White

RAL 9005 Matt Black

## FACTORY IP65 2L SUSPENDED

## MATT WHITE FINISHING

Beam Angle (°)	c (mm)	Output (lm)	System (W)	ON/OFF	DALI
<b>4000 K</b>					
60°	370	3419	24	33.63.003.08.28	33.63.003.08.44
	660	6839	48	33.63.003.08.30	33.63.003.08.46
	945	10259	73	33.63.003.08.32	33.63.003.08.48
90°	1230	13679	97	33.63.003.08.34	33.63.003.08.50
	370	3357	24	33.63.003.08.36	33.63.003.08.52
	660	6715	48	33.63.003.08.38	33.63.003.08.54
90°	945	10073	73	33.63.003.08.40	33.63.003.08.56
	1230	13430	97	33.63.003.08.42	33.63.003.08.58
	<b>5000 K</b>				
60°	370	3474	24	33.63.003.08.92	33.63.004.08.08
	660	6948	48	33.63.003.08.94	33.63.004.08.10
	945	10422	73	33.63.003.08.96	33.63.004.08.12
90°	1230	13896	97	33.63.003.08.98	33.63.004.08.14
	370	3411	24	33.63.004.08.00	33.63.004.08.16
	660	6822	48	33.63.004.08.02	33.63.004.08.18
90°	945	10233	73	33.63.004.08.04	33.63.004.08.20
	1230	13644	97	33.63.004.08.06	33.63.004.08.22

## OPTIONS

## LED

3000 K, 6500 K

## ELECTRICAL SYSTEM

DSI, DIM 1-10V

## FINISHING

Other Colours

## EMERGENCY

1 Hour, 3 Hours

DALI 1 Hour, 3 Hours

## SENSORS

Motion

Ambient Light

Motion &amp; Ambient Light

## MATT BLACK FINISHING

Beam Angle (°)	c (mm)	Output (lm)	System (W)	ON/OFF	DALI
<b>4000 K</b>					
60°	370	3419	24	33.63.003.08.60	33.63.003.08.76
	660	6839	48	33.63.003.08.62	33.63.003.08.78
	945	10259	73	33.63.003.08.64	33.63.003.08.80
90°	1230	13678	97	33.63.003.08.66	33.63.003.08.82
	370	3357	24	33.63.003.08.68	33.63.003.08.84
	660	6715	48	33.63.003.08.70	33.63.003.08.86
90°	945	10073	73	33.63.003.08.72	33.63.003.08.88
	1230	13430	97	33.63.003.08.74	33.63.003.08.90
	<b>5000 K</b>				
60°	370	3474	24	33.63.004.08.24	33.63.004.08.40
	660	6948	48	33.63.004.08.26	33.63.004.08.42
	945	10422	73	33.63.004.08.28	33.63.004.08.44
90°	1230	13896	97	33.63.004.08.30	33.63.004.08.46
	370	3411	24	33.63.004.08.32	33.63.004.08.48
	660	6822	48	33.63.004.08.34	33.63.004.08.50
90°	945	10233	73	33.63.004.08.36	33.63.004.08.52
	1230	13644	97	33.63.004.08.38	33.63.004.08.54



35 mm

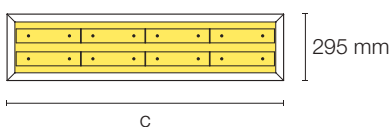

c

**QUICK INFO**

**GENERAL**

Suspended / Surface  
 IP65  
 IK09  
 960°C  
 Class I  
 Ta= -20°C +45°C

**OPTIC**

PMMA Lens  
 Clear Tempered Glass

**LED**

Efficacy up to 176 lm/W  
 4000 K, 5000 K  
 CRI >85  
 Lifetime 54 000 H  
 L80/B10 @Tc=75°C

**ELETRICAL SYSTEM**

230V/50Hz  
 ON/OFF, DALI

**FINISHING**

RAL 9003 Matt White  
 RAL 9005 Matt Black

**OPTIONS**

**LED**

3000 K, 6500 K

**ELECTRICAL SYSTEM**

DSI, DIM 1-10V

**FINISHING**

Other Colours

**EMERGENCY**

1 Hour, 3 Hours  
 DALI 1 Hour, 3 Hours

**SENSORS**

Motion  
 Ambient Light  
 Motion & Ambient Light

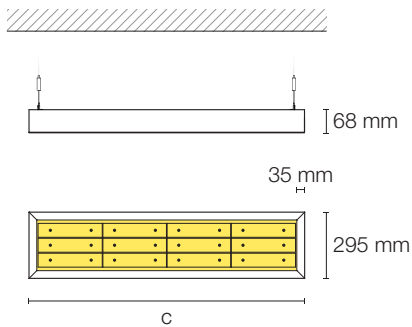

**FACTORY IP65 3L SUSPENDED / SURFACE**

**MATT WHITE FINISHING**

Beam Angle (°)	c (mm)	Output (lm)	System (W)	ON/OFF	DALI
<b>4000 K</b>					
60°	370	4998	36	33.63.003.08.29	33.63.003.08.45
	660	9996	73	33.63.003.08.31	33.63.003.08.47
	945	14995	109	33.63.003.08.33	33.63.003.08.49
90°	1230	19993	145	33.63.003.08.35	33.63.003.08.51
	370	4855	36	33.63.003.08.37	33.63.003.08.53
	660	9711	73	33.63.003.08.39	33.63.003.08.55
90°	945	14567	109	33.63.003.08.41	33.63.003.08.57
	1230	19423	145	33.63.003.08.43	33.63.003.08.59
	<b>5000 K</b>				
60°	370	5077	36	33.63.003.08.93	33.63.004.08.09
	660	10155	73	33.63.003.08.95	33.63.004.08.11
	945	15233	109	33.63.003.08.97	33.63.004.08.13
90°	1230	20311	145	33.63.003.08.99	33.63.004.08.15
	370	4932	36	33.63.004.08.01	33.63.004.08.17
	660	9865	73	33.63.004.08.03	33.63.004.08.19
90°	945	14798	109	33.63.004.08.05	33.63.004.08.21
	1230	19731	145	33.63.004.08.07	33.63.004.08.23

**MATT BLACK FINISHING**

Beam Angle (°)	c (mm)	Output (lm)	System (W)	ON/OFF	DALI
<b>4000 K</b>					
60°	370	4998	36	33.63.003.08.61	33.63.003.08.77
	660	9996	73	33.63.003.08.63	33.63.003.08.79
	945	14995	109	33.63.003.08.65	33.63.003.08.81
90°	1230	19993	145	33.63.003.08.67	33.63.003.08.83
	370	4855	36	33.63.003.08.69	33.63.003.08.85
	660	9711	73	33.63.003.08.71	33.63.003.08.87
90°	945	14567	109	33.63.003.08.73	33.63.003.08.89
	1230	19423	145	33.63.003.08.75	33.63.003.08.91
	<b>5000 K</b>				
60°	370	5077	36	33.63.004.08.25	33.63.004.08.41
	660	10155	73	33.63.004.08.27	33.63.004.08.43
	945	15233	109	33.63.004.08.29	33.63.004.08.45
90°	1230	20311	145	33.63.004.08.31	33.63.004.08.47
	370	4932	36	33.63.004.08.33	33.63.004.08.49
	660	9865	73	33.63.004.08.35	33.63.004.08.51
90°	945	14798	109	33.63.004.08.37	33.63.004.08.53
	1230	19731	145	33.63.004.08.39	33.63.004.08.55

# FACTORY IP65 SUSPENDED / SURFACE

## COMPONENTS

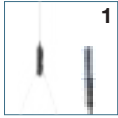

1

### SUSPENSION SYSTEM (2pcs)

TYPE	3m	5m	10m
1 - Stainless Steel Cable - Screw	35.63.002.08.03	35.63.002.08.04	35.63.002.08.05
2 - Stainless Steel Cable - Tie	35.63.002.08.00	35.63.002.08.01	35.63.002.08.02

**GRIPPLE®** Certified Suspension

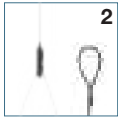

2



### SURFACE MOUNTING SYSTEM (2pcs)

TYPE	WHITE	BLACK
Surface Mounting System	35.63.002.08.06	35.63.002.08.07

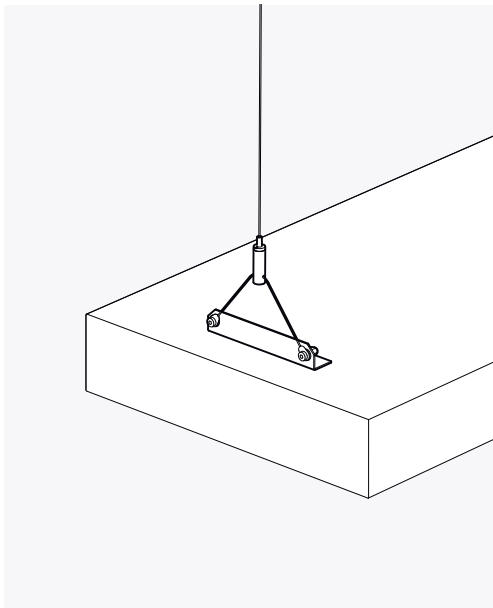

> Suspension Mounting System

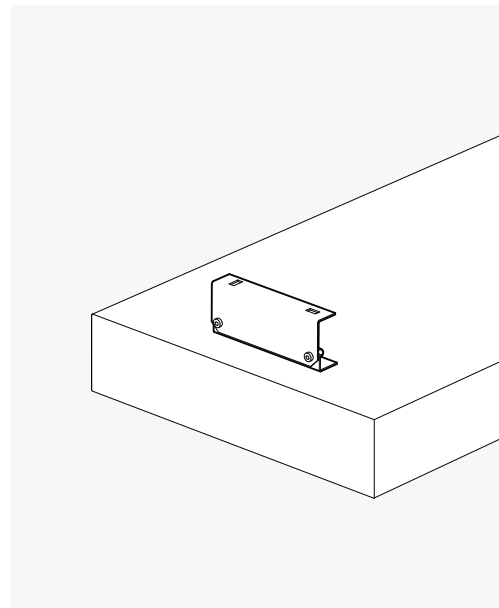

> Surface Mounting System

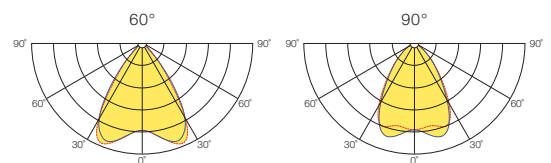

**FOCUS**  
SUSPENDED





> **FOCUS 120°** SUSPENDED

# FOCUS IP65

## SUSPENDED



### PT

- > Luminária industrial LED com emissão direta do fluxo luminoso.
- > Índice de proteção IP65 e resistência a impactos IK10.
- > Suspensão de ponto único em gancho de fixação central.
- > Refletor em alumínio com três opções de ângulo de abertura do feixe: 60°, 90° ou 120°.
- > Luminária com alhetas de refrigeração desenhadas para otimização da gestão térmica.
- > Corpo em alumínio com revestimento a epoxy-poliéster preto mate.

### ES

- > Luminaria para grandes alturas con LED e emisión directa del flujo luminoso.
- > Grado de protección IP65 y resistencia a los impactos IK10.
- > Suspensión por un punto en un gancho de sujeción ubicado en el centro.
- > Reflector en aluminio con tres opciones de ángulo de emisión: 60°, 90° o 120°.
- > Luminaria con aletas de refrigeración diseñadas para optimizar la gestión térmica.
- > Cuerpo en aluminio con recubrimiento epoxy-poliéster negro mate.

**QUICK INFO**

**GENERAL**

Suspended  
 IP65 (Optic)  
 IP40  
 IK10  
 960°C  
 Class I  
 Ta= -20°C +40°C

**OPTIC**

Matt Aluminium Reflector

**LED**

Efficacy up to 159 lm/W  
 5000 K  
 CRI >80  
 Lifetime 50 000 H  
 L70/B10 @TC=85°C

**ELETRICAL SYSTEM**

230V/50Hz  
 DIM 1-10V

**FINISHING**

RAL 9005 Matt Black

**FOCUS IP65 SUSPENDED  
 MATT ALUMINIUM REFLECTOR**

Beam Angle (°)	c (mm)	Output (lm)	System (W)	DIM
<b>5000 K</b>				
60°	590	27972	235	33.63.000.08.02
90°	515	19720	150	33.63.000.08.00
	520	27583	235	33.63.000.08.03
120°	470	19585	150	33.63.000.08.01
	475	28005	235	33.63.000.08.04

**COMPONENTS**

**SUSPENSION SYSTEM (2pcs)**



TYPE	3m	5m	10m
1 - Stainless Steel - Screw	61.01.83.000.00	61.01.83.000.01	61.01.83.000.02
2 - Stainless Steel - Tie	61.01.83.000.03	61.01.83.000.04	61.01.83.000.05

**GRIPPLE®** Certified Suspension

**OPTIONS**

**LED**

2700 K, 5000 K, 6500 K

**SENSORS**

Motion  
 Ambient Light  
 Motion & Ambient Light

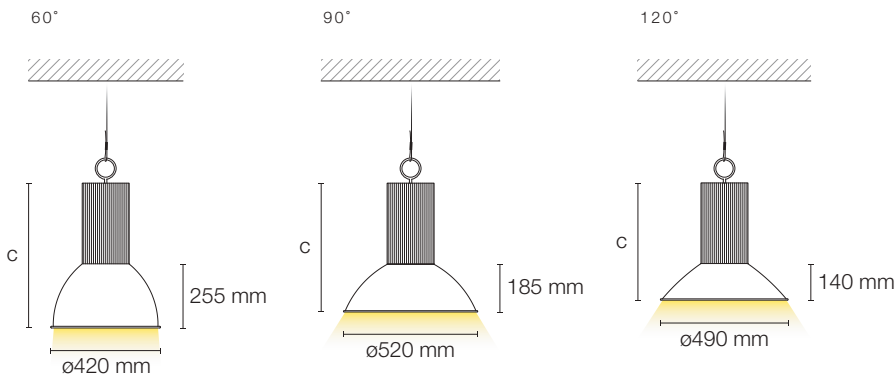
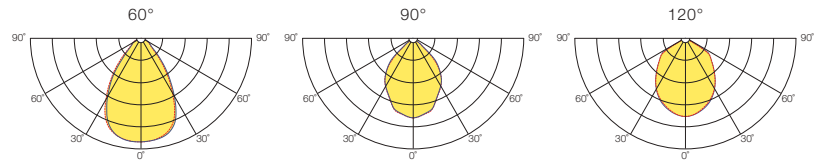

**EME**  
EMERGENCY







# EME TUBE SUSPENDED



## PT

- > Luminária de saída de emergência com pictograma de leitura dupla-face para aplicação suspensa.
- > Modo de funcionamento permanente.
- > Bateria integrada com autonomia de 3 horas em modo de emergência.
- > Sistema com botão de auto-teste e LED indicativo do estado da luminária.
- > Conforme à norma EN 60598-2-22 (Luminárias para iluminação de emergência).
- > Aplicação por cabos de aço inox com ajuste rápido da altura.
- > Painel em Policarbonato transparente com pictograma saída de emergência.
- > Corpo cilíndrico em Policarbonato Opal.

## ES

- > Luminaria de salida de emergencia con rótulo de señalización doble cara para instalación suspendida.
- > Funcionamiento en modo permanente.
- > Batería individual con autonomía de 3 horas en funcionamiento de emergencia.
- > Sistema con botón ensayo manual y LED para indicación del estado de la luminaria.
- > De acuerdo a la normativa EN 60598-2-22 (Luminarias para alumbrado de emergencia).
- > Aplicación por cables de acero inoxidable con regulación de la altura.
- > Panel en Policarbonato transparente con símbolo de salida de emergencia.
- > Cuerpo cilíndrico en Policarbonato Opal.

**QUICK INFO**

**GENERAL**

Suspended  
IP30  
IK04  
850°C  
Class II  
Ta= -20°C +35°C

**OPTIC**

Clear Polycarbonate

**LED**

Efficacy up to 108 lm/W  
6500 K  
CRI >80  
Lifetime 50 000 H  
L70/B10 @Tc=65°C

**ELECTRICAL SYSTEM**

230V/50Hz  
ON/OFF

**EMERGENCY**

3 Hours  
Maintained Mode

**OPTIONS**

**ELECTRICAL SYSTEM**

DALI

**EMERGENCY**

DALI 3 Hours  
Non-maintained Mode

**EME TUBE SUSPENDED**

Output (lm)	System (W)	<sup>(1)</sup> DVM (m)	TYPE		ON/OFF
<b>6500 K</b>					
152	1,4	20	B	↓	33.08.000.08.47
152	1,4	20	D	→	33.08.000.08.48
152	1,4	20	E	←	33.08.000.08.49
152	1,4	20	DD	↘	33.08.000.08.50
152	1,4	20	DE	↙	33.08.000.08.51
152	1,4	20	SD	↗	33.08.000.08.52
152	1,4	20	SE	↖	33.08.000.08.67

<sup>(1)</sup> DVM - Maximum Viewing Distance.

> Fluorescent lamp versions also available – product data at [www.climarlighting.com](http://www.climarlighting.com) – or by direct request to the factory.



**COMPONENTS**

**SUSPENSION SYSTEM (2pcs)**



TYPE	1 m	3 m	5 m
Matt White	35.49.003.01.72	35.49.003.01.73	35.49.003.01.74

**SURFACE CEILING CUP (1pc)**

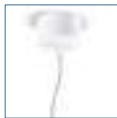

TYPE	1 m	3 m	5 m
Matt White Ø62x36 mm	35.08.000.08.49	35.08.000.08.50	35.08.000.08.51

**RECESSED CEILING CUP (1pc)**

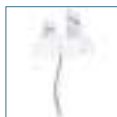

TYPE	1 m	3 m	5 m
Matt White Ø80 mm	35.08.000.08.52	35.08.000.08.53	35.08.000.08.54

**OPTIONS**

**CENTRAL SWITCH (1pc)**



ON/OFF	COD
Central Switch Emergency	35.08.000.08.48

> Max number of luminaires per remote control: 100 units.

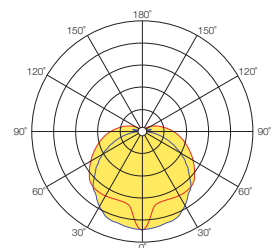
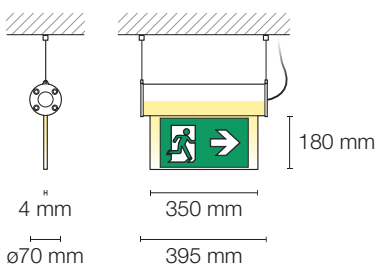

## EME TUBE SURFACE



### PT

- > Luminária de saída de emergência com pictograma de leitura dupla-face para aplicação saliente.
- > Modo de funcionamento permanente.
- > Bateria integrada com autonomia de 3 horas em modo de emergência.
- > Sistema com botão de auto-teste e LED indicativo do estado da luminária.
- > Conforme à norma EN 60598-2-22 (Luminárias para iluminação de emergência).
- > Aplicação no teto ou parede com peças de fixação em Policarbonato.
- > Painel em Policarbonato transparente com pictograma saída de emergência.
- > Corpo cilíndrico em Policarbonato Opal.

### ES

- > Luminaria de salida de emergencia con rótulo de señalización doble cara aplicación en superficie.
- > Funcionamiento en modo permanente.
- > Bateria individual con autonomía de 3 horas en funcionamiento de emergencia.
- > Sistema con botón ensayo manual y LED para indicación del estado de la luminaria.
- > De acuerdo a la normativa EN 60598-2-22 (Luminarias para alumbrado de emergencia).
- > Aplicación en el techo o pared por soportes de fijación en Policarbonato.
- > Panel en Policarbonato transparente con símbolo salida de emergencia.
- > Cuerpo cilíndrico en Policarbonato Opal.

**QUICK INFO**

**GENERAL**

Surface  
 IP30  
 IK04  
 850°C  
 Class II  
 Ta= -20°C +35°C

**OPTIC**

Clear Polycarbonate

**LED**

Efficacy up to 108 lm/W  
 6500 K  
 CRI >80  
 Lifetime 50 000 H  
 L70/B10 @Tc=65°C

**ELECTRICAL SYSTEM**

230V/50Hz  
 ON/OFF

**EMERGENCY**

3 Hours  
 Maintained Mode

**OPTIONS**

**ELECTRICAL SYSTEM**

DALI

**EMERGENCY**

DALI 3 Hours  
 Non-maintained Mode

**EME TUBE SURFACE**

Output (lm)	System (W)	<sup>(1)</sup> DVM (m)	TYPE		ON/OFF
<b>6500 K</b>					
152	1,4	20	B	↓	33.08.000.08.39
152	1,4	20	D	→	33.08.000.08.40
152	1,4	20	E	←	33.08.000.08.41
152	1,4	20	DD	↘	33.08.000.08.42
152	1,4	20	DE	↙	33.08.000.08.43
152	1,4	20	SD	↗	33.08.000.08.44
152	1,4	20	SE	↖	33.08.000.08.45

<sup>(1)</sup> DVM - Maximum Viewing Distance.

> Fluorescent lamp versions also available – product data at [www.climarlighting.com](http://www.climarlighting.com) – or by direct request to the factory.



**COMPONENTS**



**SURFACE CEILING CUP (1pc)**

TYPE	1 m	3 m	5 m
Matt White Ø62x36 mm	35.08.000.08.49	35.08.000.08.50	35.08.000.08.51

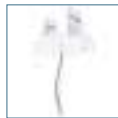

**RECESSED CEILING CUP (1pc)**

TYPE	1 m	3 m	5 m
Matt White Ø80 mm	35.08.000.08.52	35.08.000.08.53	35.08.000.08.54

**OPTIONS**



**CENTRAL SWITCH (1pc)**

ON/OFF	COD
Central Switch Emergency	35.08.000.08.48

> Max number of luminaires per remote control: 100 units.

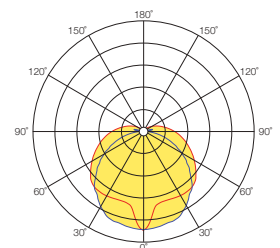
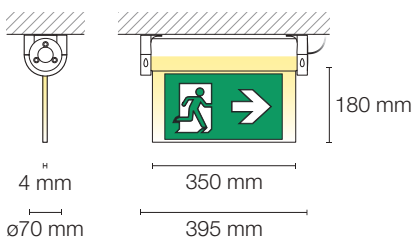

# EME SURFACE



## PT

- > Luminária de saída de emergência com pictograma de leitura dupla-face para aplicação saliente no teto.
- > Modo de funcionamento permanente.
- > Bateria integrada com autonomia de 3 horas em modo de emergência.
- > Sistema com botão de auto-teste e LED indicativo do estado da luminária.
- > Conforme à norma EN 60598-2-22 (Luminárias para iluminação de emergência).
- > Painel em PMMA transparente com retroiluminação do pictograma de saída.
- > Corpo em alumínio com revestimento a epoxy-poliéster.

## ES

- > Luminaria de salida de emergencia doble cara para instalación directa en el techo.
- > Funcionamiento en modo permanente.
- > Bateria individual con autonomía de 3 horas en funcionamiento de emergencia.
- > Sistema con botón ensayo manual y LED para indicación del estado de la luminaria.
- > De acuerdo a la normativa EN 60598-2-22 (Luminarias para alumbrado de emergencia).
- > Panel en PMMA transparente con retroiluminación del símbolo de salida.
- > Cuerpo en aluminio con recubrimiento epoxi-poliéster.

**QUICK INFO**

**GENERAL**

Surface  
 IP40  
 IK04  
 650°C  
 Class II  
 Ta= -20°C +35°C

**OPTIC**

Clear PMMA

**LED**

Efficacy up to 108 lm/W  
 6500 K  
 CRI >80  
 Lifetime 50 000 H  
 L70/B10 @Tc=65°C

**ELETRICAL SYSTEM**

230V/50Hz  
 ON/OFF

**EMERGENCY**

3 Hours  
 Maintained Mode

**OPTIONS**

**ELECTRICAL SYSTEM**

DALI

**EMERGENCY**

DALI 3 Hours  
 Non-maintained Mode

**EME SURFACE**

Output (lm)	System (W)	<sup>(1)</sup> DVM (m)	TYPE	ON/OFF
<b>6500 K</b>				
48	1,4	20	B ↓	33.41.42.024066
48	1,4	20	D →	33.41.42.024067
48	1,4	20	E ←	33.41.42.024068
48	1,4	20	DD ↘	33.41.42.024069
48	1,4	20	DE ↙	33.41.42.024072
48	1,4	20	SD ↗	33.41.42.024070
48	1,4	20	SE ↖	33.41.42.024071

<sup>(1)</sup> DVM - Maximum Viewing Distance.



**OPTIONS**

**CENTRAL SWITCH (1pc)**



**ON/OFF**

Central Switch Emergency

**COD**

35.08.000.08.48

> Max number of luminaires per remote control: 100 units.

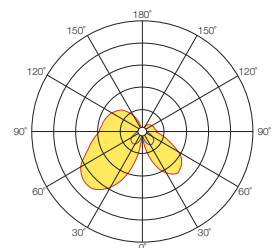
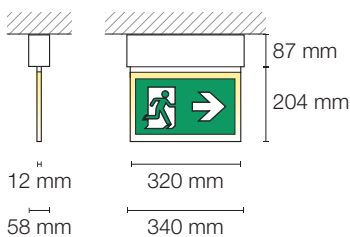

# EME

## RECESSED



### PT

- > Luminária de saída de emergência com pictograma de leitura dupla-face para aplicação encastrada no teto.
- > Modo de funcionamento permanente.
- > Bateria integrada com autonomia de 3 horas em modo de emergência.
- > Sistema com botão de auto-teste e LED indicativo do estado da luminária.
- > Conforme à norma EN 60598-2-22 (Luminárias para iluminação de emergência).
- > Painel em PMMA transparente com retroiluminação do pictograma de saída.
- > Corpo em chapa de aço com revestimento a epoxy-poliéster.

### ES

- > Luminaria de salida de emergencia doble cara para instalación empotrada en el techo.
- > Funcionamiento en modo permanente.
- > Bateria individual con autonomía de 3 horas en funcionamiento de emergencia.
- > Sistema con botón ensayo manual y LED para indicación del estado de la luminaria.
- > De acuerdo a la normativa EN 60598-2-22 (Luminarias para alumbrado de emergencia).
- > Panel en PMMA transparente con retroiluminación del símbolo de salida.
- > Cuerpo de chapa de acero con recubrimiento epoxi-poliéster.



**QUICK INFO**

**GENERAL**

Recessed  
 IP40 (Optic)  
 IP20  
 IK04  
 650°C  
 Class II  
 Ta= -20°C +35°C

**OPTIC**

Clear PMMA

**LED**

Efficacy up to 108 lm/W  
 6500 K  
 CRI >80  
 Lifetime 50 000 H  
 L70/B10 @Tc=65°C

**ELECTRICAL SYSTEM**

230V/50Hz  
 ON/OFF

**EMERGENCY**

3 Hours  
 Maintained Mode

**OPTIONS**

**ELECTRICAL SYSTEM**

DALI

**EMERGENCY**

DALI 3 Hours  
 Non-maintained Mode

**EME RECESSED**

Output (lm)	System (W)	<sup>(1)</sup> DVM (m)	TYPE		ON/OFF
<b>6500 K</b>					
48	1,4	20	B	↓	33.41.42.024084
48	1,4	20	D	→	33.41.42.024063
48	1,4	20	E	←	33.41.42.024064
48	1,4	20	DD	↘	33.41.42.024085
48	1,4	20	DE	↙	33.41.42.024088
48	1,4	20	SD	↗	33.41.42.024086
48	1,4	20	SE	↖	33.41.42.024087

<sup>(1)</sup> DVM - Maximum Viewing Distance.



**OPTIONS**

**CENTRAL SWITCH (1pc)**



**ON/OFF**

Central Switch Emergency

**COD**

35.08.000.08.48

> Max number of luminaires per remote control: 100 units.

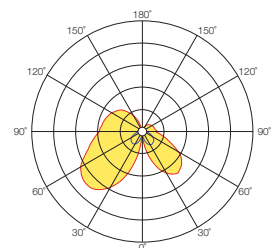

# EME WALL



## PT

- > Luminária de saída de emergência com pictograma de leitura dupla-face para aplicação saliente na parede (tipo bandeirola).
- > Modo de funcionamento permanente.
- > Bateria integrada com autonomia de 3 horas em modo de emergência.
- > Sistema com botão de auto-teste e LED indicativo do estado da luminária.
- > Conforme à norma EN 60598-2-22 (Luminárias para iluminação de emergência).
- > Painel em PMMA transparente com retroiluminação do pictograma de saída.
- > Corpo em alumínio com revestimento a epoxy-poliéster.

## ES

- > Luminaria de salida de emergencia doble cara para instalación en pared (tipo bandera).
- > Funcionamiento en modo permanente.
- > Bateria individual con autonomía de 3 horas en funcionamiento de emergencia.
- > Sistema con botón ensayo manual y LED para indicación del estado de la luminaria.
- > De acuerdo a la normativa EN 60598-2-22 (Luminarias para alumbrado de emergencia).
- > Panel en PMMA transparente con retroiluminación del símbolo de salida.
- > Cuerpo en aluminio con recubrimiento epoxi-poliéster.

**QUICK INFO**

**GENERAL**

Wall  
 IP40  
 IK04  
 650°C  
 Class II  
 Ta= -20°C +35°C

**OPTIC**

Clear PMMA

**LED**

Efficacy up to 108 lm/W  
 6500 K  
 CRI >80  
 Lifetime 50 000 H  
 L70/B10 @Tc=65°C

**ELETRICAL SYSTEM**

230V/50Hz  
 ON/OFF

**EMERGENCY**

3 Hours  
 Maintained Mode

**OPTIONS**

**ELECTRICAL SYSTEM**

DALI

**EMERGENCY**

DALI 3 Hours  
 Non-maintained Mode

**EME WALL - LEFT**

Output (lm)	System (W)	<sup>(1)</sup> DVM (m)	TYPE		ON/OFF
<b>6500 K</b>					
48	1,4	20	B	↓	33.41.42.024077
48	1,4	20	D	→	33.41.42.024078
48	1,4	20	E	←	33.41.42.024079
48	1,4	20	DD	↘	33.41.42.024080
48	1,4	20	DE	↙	33.41.42.024083
48	1,4	20	SD	↗	33.41.42.024081
48	1,4	20	SE	↖	33.41.42.024082

**EME WALL - RIGHT**

Output (lm)	System (W)	<sup>(1)</sup> DVM (m)	TYPE		ON/OFF
<b>6500 K</b>					
48	1,4	20	B	↓	33.41.42.024016
48	1,4	20	D	→	33.41.42.024014
48	1,4	20	E	←	33.41.42.024015
48	1,4	20	DD	↘	33.41.42.024017
48	1,4	20	DE	↙	33.41.42.024020
48	1,4	20	SD	↗	33.41.42.024018
48	1,4	20	SE	↖	33.41.42.024019

<sup>(1)</sup> DVM - Maximum Viewing Distance.



**OPTIONS**

**CENTRAL SWITCH (1pc)**



**ON/OFF**

Central Switch Emergency

**COD**

35.08.000.08.48

> Max number of luminaires per remote control: 100 units.

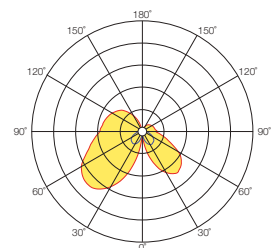
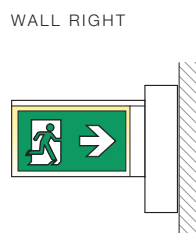
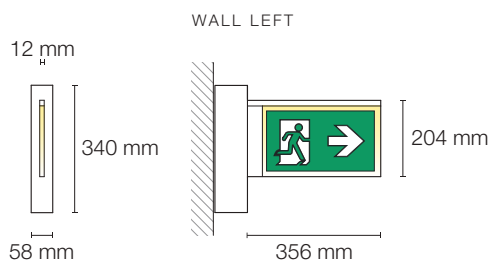

# EME

## WALL SPO



### PT

- > Luminária com pictograma de saída de emergência para aplicação saliente na parede por cima de portas.
- > Modo de funcionamento permanente.
- > Bateria integrada com autonomia de 3 horas em modo de emergência.
- > Sistema com botão de auto-teste e LED indicativo do estado da luminária.
- > Conforme à norma EN 60598-2-22 (Luminárias para iluminação de emergência).
- > Painel em PMMA transparente com retroiluminação do pictograma de saída.
- > Corpo em alumínio com revestimento a epoxy-poliéster.

### ES

- > Luminaria de salida de emergencia con rótulo de señalización para instalación en la pared por encima de puertas.
- > Funcionamiento en modo permanente.
- > Bateria individual con autonomía de 3 horas en funcionamiento de emergencia.
- > Sistema con botón ensayo manual y LED para indicación del estado de la luminaria.
- > De acuerdo a la normativa EN 60598-2-22 (Luminarias para alumbrado de emergencia).
- > Panel en PMMA transparente con retroiluminación del símbolo de salida.
- > Cuerpo en aluminio con recubrimiento epoxi-poliéster.

**QUICK INFO**

**GENERAL**

Wall  
 IP40  
 IK04  
 650°C  
 Class II  
 Ta= -20°C +35°C

**OPTIC**

Clear PMMA

**LED**

Efficacy up to 108 lm/W  
 6500 K  
 CRI >80  
 Lifetime 50 000 H  
 L70/B10 @Tc=65°C

**ELETRICAL SYSTEM**

230V/50Hz  
 ON/OFF

**EMERGENCY**

3 Hours  
 Maintained Mode

**OPTIONS**

**ELECTRICAL SYSTEM**

DALI

**EMERGENCY**

DALI 3 Hours  
 Non-maintained Mode

**EME WALL SPO**

Output (lm)	System (W)	<sup>(1)</sup> DVM (m)	TYPE		ON/OFF
<b>6500 K</b>					
48	1,4	20	B	↓	33.41.42.124042
48	1,4	20	D	→	33.41.42.124040
48	1,4	20	E	←	33.41.42.124041
48	1,4	20	DD	↘	33.41.42.124043
48	1,4	20	DE	↙	33.41.42.124046
48	1,4	20	SD	↗	33.41.42.124044
48	1,4	20	SE	↖	33.41.42.124045

<sup>(1)</sup> DVM - Maximum Viewing Distance.



**OPTIONS**

**CENTRAL SWITCH (1pc)**



**ON/OFF**

Central Switch Emergency

**COD**

35.08.000.08.48

> Max number of luminaires per remote control: 100 units.

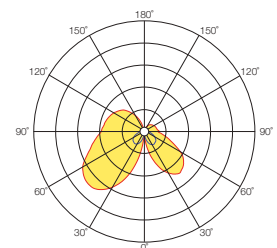
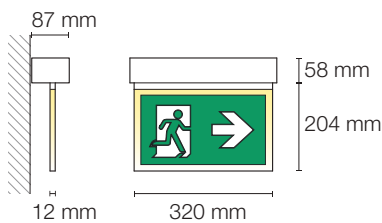



# OUTDOOR LIGHTING

## **IN-GROUND**

pag. 630

## **SPOTLIGHTS**

pag. 654

## **DOWNLIGHTS**

pag. 668

## **WALL**

pag. 678

## **WALLWASHER**

pag. 694

## **BOLLARDS**

pag. 700

## **COLUMNS**

pag. 714

**WELEX**  
EXTERIOR LIGHTING

**LANIN**  
IN-GROUND

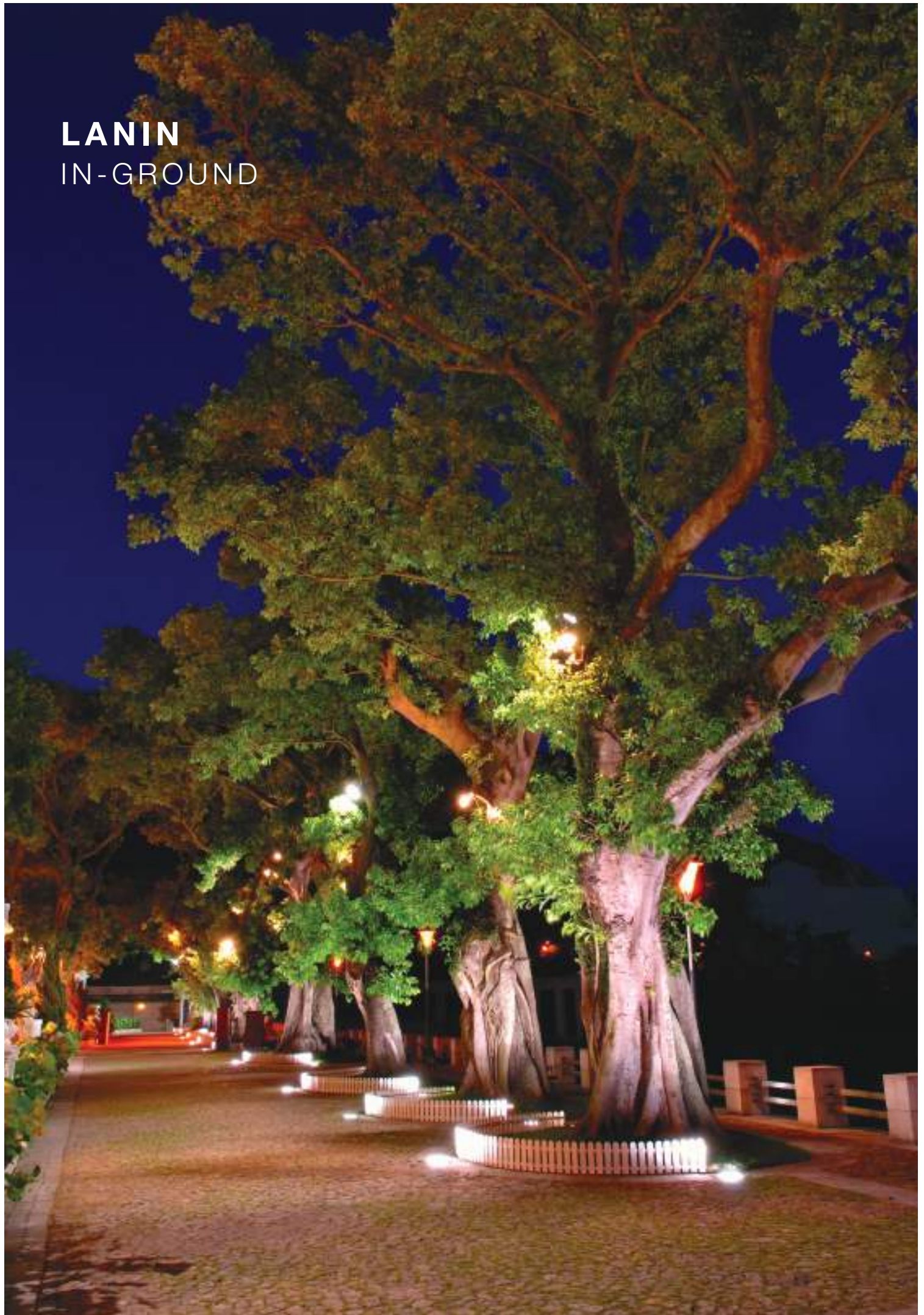





> LANIN 28 IN-GROUND

# LANIN 28

## IN-GROUND



### PT

- > Luminária compacta em aço inox para aplicação encastrada no pavimento ou na parede.
- > Diâmetro de 28 mm proporcionando iluminação de orientação e marcação.
- > Resistência a uma carga estática de 1500 kg.
- > Driver externo de tensão constante e classe de proteção II.
- > Pré-cablado com cabo H05RN-F de 1000 mm para rapidez e facilidade de instalação.
- > Inclui caixa de embutir em alumínio.
- > Difusor Opal em vidro temperado.
- > Corpo e aro em aço inox AISI 316 sem parafusos visíveis.

### ES

- > Luminaria compacta en acero inoxidable para instalación empotrada en el suelo o en la pared.
- > Diámetro de 28 mm proporcionando iluminación de marcado y orientación.
- > Resistencia a la carga estática 1500 kg.
- > Driver externo de tensión constante y clase de protección II.
- > Precableado con cable H05RN-F de 1000 mm para una instalación rápida y fácil.
- > Incluye caja de empotramiento en aluminio.
- > Difusor en vidrio Opal templado.
- > Cuerpo y aro en acero inoxidable AISI 316 sin tornillos visibles.

**QUICK INFO**

**GENERAL**

Recessed  
 IP67  
 IK10  
 960°C  
 Class III  
 Ta= -20°C +40°C

**OPTIC**

Opal Tempered Glass

**LED**

Efficacy up to 80 lm/W  
 3000 K, 5000 K, Blue  
 CRI >80  
 Lifetime 50 000 H  
 L80/B10 @Tc=65°C  
 24 VDC

**ELETRICAL SYSTEM**

230V/50Hz  
 ON/OFF

**FINISHING**

Fine Brushed Stainless Steel

**LANIN 28**

**FINE BRUSHED STAINLESS STEEL FINISHING**

Output (lm)	LED Power (W)	LED Voltage	COD
<b>3000 K</b>			
30	0,5	24 VDC	32.WX.002.08.51
<b>5000 K</b>			
40	0,5	24 VDC	32.WX.000.08.01
<b>Blue</b>			
10	0,5	24 VDC	32.WX.002.08.52

**COMPONENTS**

**DRIVER - EXTERNAL**



CLASS II

ON/OFF	DIMENSION	COD
Power Supply 0-9W IP20	22x38x55 mm	35.92.00.000057
Power Supply 0-5W IP20	22x32x76 mm	35.92.00.000058
Power Supply 0-13W IP65	19x39x85 mm	35.92.00.000059

> External Driver to be housed nearby.

**OPTIONS**

**FINISHING**

Other Colours

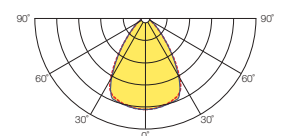
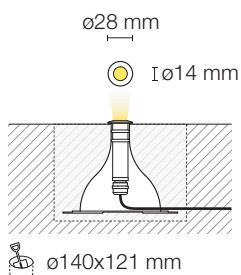

# LANIN 42

## IN-GROUND



### PT

- > Luminária compacta para aplicação encastrada no pavimento ou na parede.
- > Diâmetro de 42 mm para iluminação de realce ou funções de marcação e orientação.
- > Lentes com ângulo de abertura 12°, 35° ou 48° protegidas por vidro temperado transparente.
- > Resistência a uma carga estática de 500 kg.
- > Driver externo de corrente constante e classe proteção II.
- > Pré-cablado com cabo H05RN-F de 5000 mm para rapidez e facilidade de instalação.
- > Inclui caixa de embutir em alumínio.
- > Corpo e aro injetados em alumínio.

### ES

- > Luminaria compacta para instalación empotrada en el suelo o en la pared.
- > Diámetro de 42 mm para iluminación de acento o funciones de marcado y orientación.
- > Lentes con ángulo de apertura 12°, 35° o 48° protegidas por vidrio templado transparente.
- > Resistencia a la carga estática 500 kg.
- > Driver externo de corriente constante y clase de protección II.
- > Precableado con cable H05RN-F de 5000 mm para una instalación rápida y fácil.
- > Incluye caja de empotramiento en aluminio.
- > Cuerpo y aro inyectado en aluminio.

**QUICK INFO**

**GENERAL**

Recessed  
 IP67  
 IK10  
 960°C  
 Class III  
 Ta= -20°C +40°C

**OPTIC**

Clear Tempered Glass  
 PMMA Lens

**LED**

Efficacy up to 130 lm/W  
 3000 K, 4000 K  
 CRI >80  
 Lifetime 50 000 H  
 L80/B10 @Tc=65°C  
 350 mA, 700 mA

**ELETRICAL SYSTEM**

230V/50Hz  
 ON/OFF, DALI

**FINISHING**

Matt Anodized Aluminium

**OPTIONS**

**LED**

2700 K, 5000 K, 6500 K

**FINISHING**

 Other Colours

**LANIN 42**

**MATT ANODIZED FINISHING**

Beam Angle (°)	Output (lm)	LED Power (W)	LED Current	COD
<b>3000 K</b>				
12°	88	1	350 mA	32.WX.002.08.53
	157	2	700 mA	32.WX.017.08.35
35°	80	1	350 mA	32.WX.002.08.54
	142	2	700 mA	32.WX.017.08.36
48°	76	1	350 mA	32.WX.002.08.55
	136	2	700 mA	32.WX.017.08.37
<b>4000 K</b>				
12°	110	1	350 mA	32.WX.002.08.56
	197	2	700 mA	32.WX.017.08.38
35°	100	1	350 mA	32.WX.002.08.57
	178	2	700 mA	32.WX.017.08.39
48°	96	1	350 mA	32.WX.002.08.58
	170	2	700 mA	32.WX.017.08.40

**COMPONENTS**

**DRIVER - EXTERNAL**



CLASS II

**ON/OFF**

ON/OFF	Current	DIMENSION	COD
Power Supply 1-3,6W IP20	350 mA	22x32x76 mm	35.06.20.007004
Power Supply 6-15W IP20	350 mA	31x70x200 mm	35.92.00.000027
Power Supply 2-7W IP20	700 mA	22x32x76 mm	35.92.00.000024
Power Supply 8-18W IP20	700 mA	23x38x125 mm	35.06.60.000661

**DALI**

DALI	Current	DIMENSION	COD
Power Supply 1-13W IP20	350 mA	22x52x111 mm	35.92.00.000025
Power Supply 2-17W IP20	700 mA	22x52x111 mm	35.92.00.000026

> External Driver to be housed nearby.

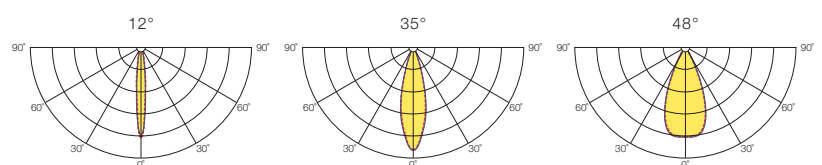
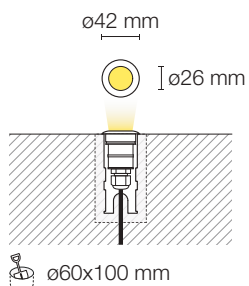



> LANIN 42 IN-GROUND



> LANIN 42 IN-GROUND

# LANIN 48

## IN-GROUND



### PT

- > Luminária para marcação e orientação de aplicação encastrada no pavimento ou na parede.
- > Em versões com um, dois ou três sectores de emissão.
- > Resistência a uma carga estática de 500 kg.
- > Pré-cablado com cabo H05RN-F de 5000 mm para rapidez e facilidade de instalação.
- > Inclui caixa de embutir em alumínio.
- > Cúpula em aço inox AISI 316 e sem parafusos visíveis.
- > Corpo em alumínio injetado anodizado.

### ES

- > Luminaria para el marcado y orientación para instalación empotrada en el pavimento o en la pared.
- > Luz rasante con emisión por un, dos o tres lados.
- > Resistencia a la carga estática 500 kg.
- > Precableado con cable H05RN-F de 5000 mm para una instalación rápida y fácil.
- > Incluye caja de empotramiento en aluminio.
- > Domo en acero inoxidable AISI 316 y sin tornillos visibles.
- > Cuerpo en aluminio inyectado anodizado.



**QUICK INFO**

**GENERAL**

Recessed  
 IP67  
 IK10  
 960°C  
 Class III  
 Ta= -20°C +40°C

**OPTIC**

Clear Tempered Glass

**LED**

Efficacy up to 130 lm/W  
 3000 K, 4000 K  
 CRI >80  
 Lifetime 50 000 H  
 L80/B10 @Tc=65°C  
 350 mA, 700 mA

**ELETRICAL SYSTEM**

230V/50Hz  
 ON/OFF, DALI

**FINISHING**

Fine Brushed Stainless Steel

**OPTIONS**

**LED**

2700 K, 5000 K, 6500 K

**FINISHING**

 Other Colours

**LANIN 48**

**FINE BRUSHED STAINLESS STEEL FINISHING**

Type	Output (lm)	LED Power (W)	LED Current	COD
<b>3000 K</b>				
I	3	1	350 mA	32.WX.002.08.59
	7	2	700 mA	32.WX.017.08.41
II	6	1	350 mA	32.WX.004.08.01
	10	2	700 mA	32.WX.017.08.42
III	8	1	350 mA	32.WX.004.08.02
	13	2	700 mA	32.WX.017.08.43
<b>4000 K</b>				
I	5	1	350 mA	32.WX.002.08.60
	7	2	700 mA	32.WX.017.08.44
II	7	1	350 mA	32.WX.004.08.04
	13	2	700 mA	32.WX.017.08.45
III	10	1	350 mA	32.WX.004.08.05
	17	2	700 mA	32.WX.017.08.46

**COMPONENTS**

**DRIVER - EXTERNAL**



CLASS II

**ON/OFF**

ON/OFF	Current	DIMENSION	COD
Power Supply 1-3,6W IP20	350 mA	22x32x76 mm	35.06.20.007004
Power Supply 6-15W IP20	350 mA	31x70x200 mm	35.92.00.000027
Power Supply 2-7W IP20	700 mA	22x32x76 mm	35.92.00.000024
Power Supply 8-18W IP20	700 mA	23x38x125 mm	35.06.60.000661

**DALI**

DALI	Current	DIMENSION	COD
Power Supply 1-13W IP20	350 mA	22x52x108 mm	35.92.00.000025
Power Supply 2-17W IP20	700 mA	22x52x108 mm	35.92.00.000026

> External Driver to be housed nearby.

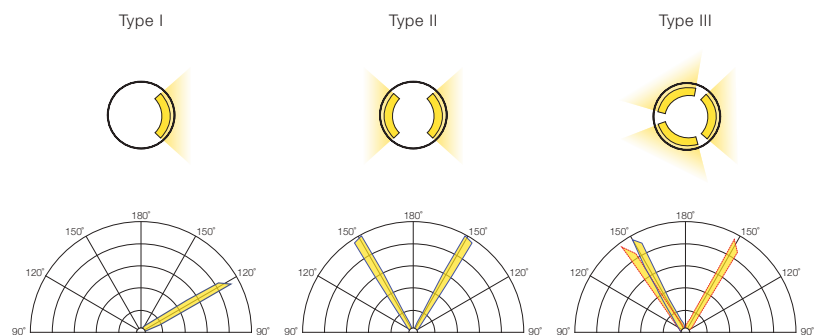
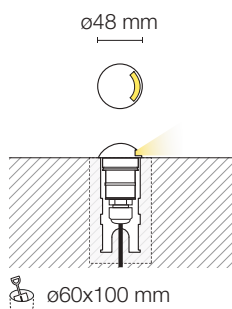

# LANIN 120

## IN-GROUND



### PT

- > Luminária de elevado desempenho para aplicação encastrada no pavimento.
- > Lentes com ângulo de abertura 12°, 35° ou 48° protegidas por vidro de segurança temperado com rebordo pintado.
- > Resistência a uma carga estática de 1500 kg.
- > Filtro de controlo encandeamento disponível como acessório.
- > Pré-cablado com cabo H05RN-F de 1000 mm para rapidez e facilidade de instalação.
- > Permite repicagem.
- > Inclui caixa de embutir em plástico.
- > Corpo em alumínio com tratamento primário anti-corrosão e revestimento a poliéster resistente aos UV.

### ES

- > Luminaria de alto rendimiento para instalación empotrada en el suelo.
- > Lentes con ángulo de apertura 12°, 35° o 48° protegidas por vidrio de seguridad templado con reborde pintado.
- > Resistencia a la carga estática 1500 kg.
- > Filtro de control del deslumbramiento disponible como accesorio.
- > Precableado con cable H05RN-F de 1000 mm para una instalación rápida y fácil.
- > Posibilidad de cableado de paso.
- > Incluye caja de empotramiento de plástico.
- > Cuerpo en aluminio con tratamiento primario anti-corrosión y recubrimiento de poliéster resistente a los UV.

**QUICK INFO**

**GENERAL**

Recessed  
 IP67  
 IK10  
 960°C  
 Class I  
 Ta= -20°C +40°C

**OPTIC**

Clear Tempered Glass  
 PMMA Lens

**LED**

Efficacy up to 130 lm/W  
 3000 K, 4000 K  
 CRI >80  
 Lifetime 50 000 H  
 L80/B10 @Tc=65°C

**ELETRICAL SYSTEM**

230V/50Hz  
 ON/OFF

**FINISHING**

RAL 9005 Matt Black

**OPTIONS**

**LED**

2700 K, 5000 K, 6500 K  
 RGB, RGBW

**LANIN 120**

**MATT BLACK FINISHING**

Beam Angle (°)	Output (lm)	System (W)	COD
<b>3000 K</b>			
12°	344	4	32.WX.002.08.61
	610	8	32.WX.002.08.63
35°	342	4	32.WX.002.08.62
	602	8	32.WX.002.08.64
48°	322	4	32.WX.002.08.17
	567	8	32.WX.002.08.20
<b>4000 K</b>			
12°	431	4	32.WX.002.08.21
	762	8	32.WX.002.08.24
35°	428	4	32.WX.002.08.22
	748	8	32.WX.002.08.25
48°	403	4	32.WX.002.08.23
	709	8	32.WX.002.08.26

**OPTIONS**

**HONEYCOMB LOUVRE**



TYPE	DIMENSION	COD
Glare Control Filter	ø50 mm	32.WX.000.01.05

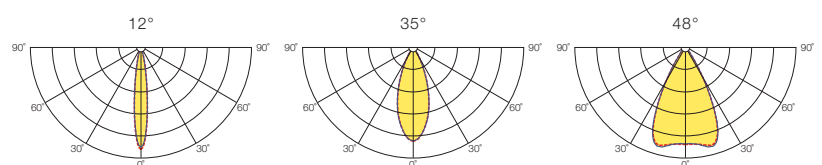
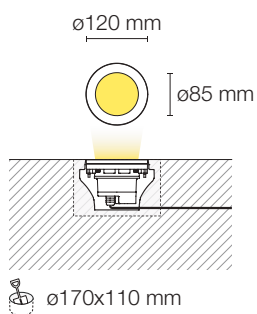

# LANIN 135

## IN-GROUND



### PT

- > Luminária de elevado desempenho para aplicação encastrada no pavimento.
- > Três opções de lente – ângulo de abertura 12°, 35° ou 48°.
- > Resistência a uma carga estática de 1500 kg.
- > Pré-cablado com cabo H05RN-F de 1000 mm para rapidez e facilidade de instalação.
- > Permite repicagem.
- > Inclui caixa de embutir em plástico.
- > Aro de remate em aço inox AISI 316, vedantes em silicone e vidro de segurança temperado.
- > Corpo em alumínio com tratamento primário anti-corrosão e revestimento a poliéster resistente aos UV.

### ES

- > Luminaria de alto rendimiento para instalación empotrada en el suelo.
- > Tres opciones de lente - ángulo de apertura 12°, 35° o 48°.
- > Resistencia a la carga estática 1500 kg.
- > Precableado con cable H05RN-F de 1000 mm para una instalación rápida y fácil.
- > Posibilidad de cableado de paso.
- > Incluye caja de empotramiento de plástico.
- > Aro en acero inoxidable AISI 316, sellado de silicona y vidrio de seguridad templado.
- > Cuerpo en aluminio con tratamiento primario anti-corrosión y recubrimiento de poliéster resistente a los UV.

**QUICK INFO**

**GENERAL**

Recessed  
 IP67  
 IK10  
 960°C  
 Class I  
 Ta= -20°C +40°C

**OPTIC**

Clear Tempered Glass  
 PMMA Lens

**LED**

Efficacy up to 130 lm/W  
 3000 K, 4000 K  
 CRI >80  
 Lifetime 50 000 H  
 L80/B10 @Tc=65°C

**ELETRICAL SYSTEM**

230V/50Hz  
 ON/OFF

**FINISHING**

Fine Brushed Stainless Steel

**OPTIONS**

**LED**

2700 K, 5000 K, 6500 K  
 RGB, RGBW

**LANIN 135**

**FINE BRUSHED STAINLESS STEEL FINISHING**

Beam Angle (°)	Output (lm)	System (W)	COD
<b>3000 K</b>			
12°	344	4	32.WX.002.08.27
	610	8	32.WX.002.08.30
35°	342	4	32.WX.002.08.28
	602	8	32.WX.002.08.31
48°	322	4	32.WX.002.08.29
	567	8	32.WX.002.08.32
<b>4000 K</b>			
12°	431	4	32.WX.002.08.33
	762	8	32.WX.002.08.36
35°	428	4	32.WX.002.08.34
	748	8	32.WX.002.08.37
48°	403	4	32.WX.002.08.35
	709	8	32.WX.002.08.38

**OPTIONS**

**HONEYCOMB LOUVRE**



TYPE	DIMENSION	COD
Glare Control Filter	ø50 mm	32.WX.000.01.05

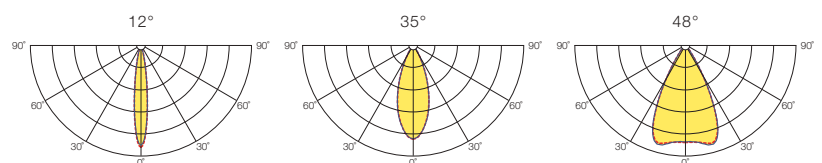
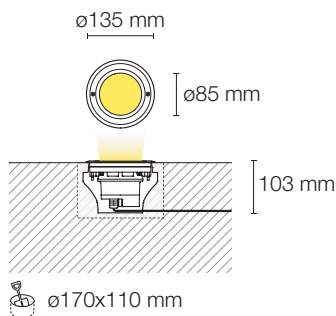



> LANIN 120 IN-GROUND



> LANIN 135 IN-GROUND

# LANIN 160

## IN-GROUND



### PT

- > Luminária de elevado desempenho para aplicação encastrada no pavimento.
- > Três opções de lente – ângulo de abertura 12°, 35° ou 48°.
- > Resistência a uma carga estática de 2000 kg.
- > Pré-cabado com cabo H05RN-F de 1000 mm para rapidez e facilidade de instalação.
- > Inclui caixa de embutir em alumínio.
- > Aro de remate em aço inox com vidro de segurança temperado.
- > Corpo em alumínio com tratamento primário anti-corrosão e revestimento a poliéster resistente aos UV.

### ES

- > Luminaria de alto rendimiento para instalación empotrada en el suelo.
- > Tres opciones de lente - ángulo de apertura 12°, 35° o 48°.
- > Resistencia a la carga estática 2000 kg.
- > Precableado con cable H05RN-F de 1000 mm para una instalación rápida y fácil.
- > Incluye caja de empotramiento en aluminio.
- > Aro en acero inoxidable con vidrio de seguridad templado.
- > Cuerpo en aluminio con tratamiento primario anti-corrosión y recubrimiento de poliéster resistente a los UV.

LANIN 160 - 7,5 / 15W





**QUICK INFO**

**GENERAL**

Recessed  
 IP67  
 IK10  
 960°C  
 Class II  
 Ta= -20°C +40°C

**OPTIC**

Clear Tempered Glass  
 PMMA Lens

**LED**

Efficacy up to 130 lm/W  
 3000 K, 4000 K  
 CRI >80  
 Lifetime 50 000 H  
 L80/B10 @Tc=65°C

**ELETRICAL SYSTEM**

230V/50Hz  
 ON/OFF

**FINISHING**

Fine Brushed Stainless Steel

**LANIN 160**

**FINE BRUSHED STAINLESS STEEL FINISHING**

Beam Angle (°)	Output (lm)	System (W)	COD
<b>3000 K</b>			
12°	706	7,5	32.WX.002.08.39
	1210	15	32.WX.002.08.42
35°	572	7,5	32.WX.002.08.40
	1174	15	32.WX.002.08.43
48°	633	7,5	32.WX.002.08.41
	1116	15	32.WX.002.08.44
<b>4000 K</b>			
12°	883	7,5	32.WX.002.08.45
	1512	15	32.WX.002.08.48
35°	715	7,5	32.WX.002.08.46
	1468	15	32.WX.002.08.65
48°	791	7,5	32.WX.002.08.47
	1396	15	32.WX.002.08.50

**OPTIONS**

**LED**

2700 K, 5000 K, 6500 K

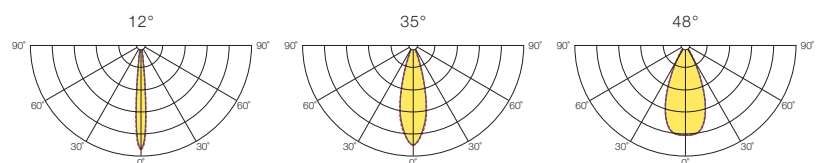
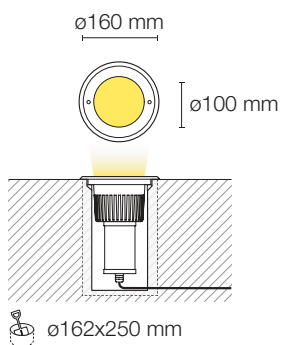

# LANIN 220

## IN-GROUND



### PT

- > Luminária de elevado desempenho para aplicação encastrada no pavimento.
- > Quatro opções de lente – ângulo de abertura 12°, 35°, 48° ou 12°x48°.
- > Feixe luminoso orientável com inclinação até 15°.
- > Resistência a uma carga estática de 2000 kg.
- > Pré-cabado com cabo H05RN-F de 1000 mm para rapidez e facilidade de instalação.
- > Permite repicagem.
- > Inclui caixa de embutir em alumínio.
- > Aro de remate em aço inox com vidro de segurança temperado.
- > Corpo em alumínio com tratamento primário anti-corrosão e revestimento a poliéster resistente aos UV.

LANIN 220 - 11W



### ES

- > Luminaria de alto rendimiento para instalación empotrada en el suelo.
- > Cuatro opciones de lente - ángulo de apertura 12°, 35°, 48° o 12°x48°.
- > Haz orientable con inclinación hasta 15°.
- > Resistencia a la carga estática 2000 kg.
- > Precableado con cable H05RN-F de 1000 mm para una instalación rápida y fácil.
- > Posibilidad de cableado de paso.
- > Incluye caja de empotramiento en aluminio.
- > Aro en acero inoxidable con vidrio de seguridad templado.
- > Cuerpo en aluminio con tratamiento primario anti-corrosión y recubrimiento de poliéster resistente a los UV.

LANIN 220 - 20 / 29W



**QUICK INFO**

**GENERAL**

Recessed  
 IP67  
 IK10  
 960°C  
 Class I  
 Ta= -20°C +40°C

**OPTIC**

Clear Tempered Glass  
 PMMA Lens

**LED**

Efficacy up to 130 lm/W  
 3000 K, 4000 K  
 CRI >80  
 Lifetime 50 000 H  
 L80/B10 @Tc=65°C

**ELETRICAL SYSTEM**

230V/50Hz  
 ON/OFF

**FINISHING**

Fine Brushed Stainless Steel

**OPTIONS**

**LED**

2700 K, 5000 K, 6500 K

**LANIN 220**

**FINE BRUSHED STAINLESS STEEL FINISHING**

Beam Angle (°)	Output (lm)	System (W)	COD
<b>3000 K</b>			
	748	11	32.WX.003.08.04
12°	1346	20	32.WX.002.08.67
	2019	29	32.WX.003.08.20
35°	710	11	32.WX.002.08.66
	1279	20	32.WX.003.08.17
	1918	29	32.WX.003.08.21
48°	674	11	32.WX.003.08.06
	1215	20	32.WX.002.08.68
	1820	29	32.WX.003.08.22
	705	11	32.WX.003.08.07
Elliptical 12°x48°	1270	20	32.WX.002.08.69
	1905	29	32.WX.003.08.23
<b>4000 K</b>			
	897	11	32.WX.003.08.12
12°	1615	20	32.WX.003.08.24
	2423	29	32.WX.003.08.28
	852	11	32.WX.002.08.70
35°	1534	20	32.WX.002.08.71
	2301	29	32.WX.003.08.29
	810	11	32.WX.003.08.14
48°	1468	20	32.WX.003.08.26
	2187	29	32.WX.003.08.30
	846	11	32.WX.003.08.15
	1524	20	32.WX.003.08.27
	2286	29	32.WX.003.08.31

**OPTIONS**

**HONEYCOMB LOUVRE**



TYPE	DIMENSION	COD
Glare Control Filter	ø122 mm	32.WX.000.01.01

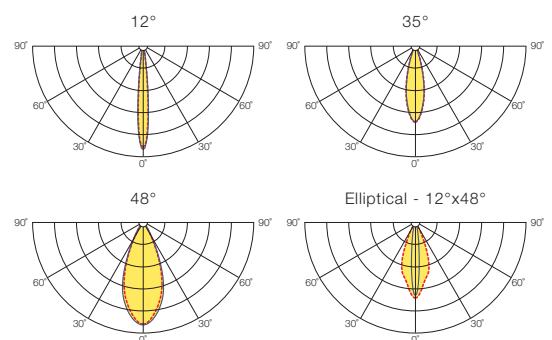
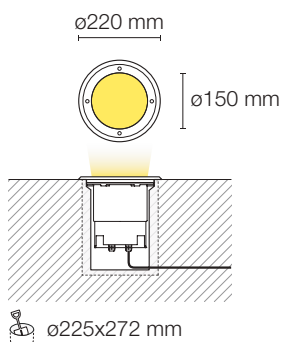

# LANIN 260

## IN-GROUND



### PT

- > Luminária de elevado desempenho para aplicação encastrada no pavimento.
- > Quatro opções de lente – ângulo de abertura 12°, 35°, 48° ou 12°x48°.
- > Feixe luminoso orientável com inclinação até 15°.
- > Resistência a uma carga estática de 2000 kg.
- > Pré-cablado com cabo H05RN-F de 1000 mm para rapidez e facilidade de instalação.
- > Permite repicagem.
- > Inclui caixa de embutir em alumínio.
- > Aro de remate em aço inox com vidro de segurança temperado.
- > Corpo em alumínio com tratamento primário anti-corrosão e revestimento a poliéster resistente aos UV.

### ES

- > Luminaria de alto rendimiento para instalación empotrada en el suelo.
- > Cuatro opciones de lente - ángulo de apertura 12°, 35°, 48° o 12°x48°.
- > Haz orientable con inclinación hasta 15°.
- > Resistencia a la carga estática 2000 kg.
- > Precableado con cable H05RN-F de 1000 mm para una instalación rápida y fácil.
- > Posibilidad de cableado de paso.
- > Incluye caja de empotramiento en aluminio.
- > Aro en acero inoxidable con vidrio de seguridad templado.
- > Cuerpo en aluminio con tratamiento primario anti-corrosión y recubrimiento de poliéster resistente a los UV.

LANIN 260 - 30 / 42W

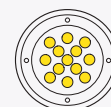

**QUICK INFO**

**GENERAL**

Recessed  
 IP67  
 IK10  
 960°C  
 Class I  
 Ta= -20°C +40°C

**OPTIC**

Clear Tempered Glass  
 PMMA Lens

**LED**

Efficacy up to 130 lm/W  
 3000 K, 4000 K  
 CRI >80  
 Lifetime 50 000 H  
 L80/B10 @Tc=65°C

**ELETRICAL SYSTEM**

230V/50Hz  
 ON/OFF

**FINISHING**

Fine Brushed Stainless Steel

**OPTIONS**

**LED**

2700 K, 5000 K, 6500 K

**LANIN 260**

**FINE BRUSHED STAINLESS STEEL FINISHING**

Beam Angle (°)	Output (lm)	System (W)	COD
<b>3000 K</b>			
12°	1944	30	32.WX.002.08.72
	2706	42	32.WX.003.08.36
35°	1837	30	32.WX.003.08.33
	2572	42	32.WX.003.08.37
48°	1745	30	32.WX.002.08.73
	2443	42	32.WX.003.08.38
Elliptical 12°x48°	1834	30	32.WX.003.08.35
	2568	42	32.WX.003.08.39
<b>4000 K</b>			
12°	2320	30	32.WX.003.08.40
	3248	42	32.WX.003.08.44
35°	2204	30	32.WX.003.08.41
	3086	42	32.WX.003.08.45
48°	2094	30	32.WX.003.08.42
	2932	42	32.WX.003.08.46
Elliptical 12°x48°	2201	30	32.WX.003.08.43
	3081	42	32.WX.003.08.47

**OPTIONS**

**HONEYCOMB LOUVRE**



TYPE	DIMENSION	COD
Glare Control Filter	ø160 mm	32.WX.000.01.02

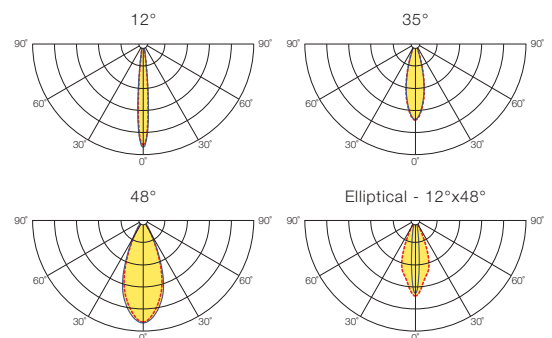
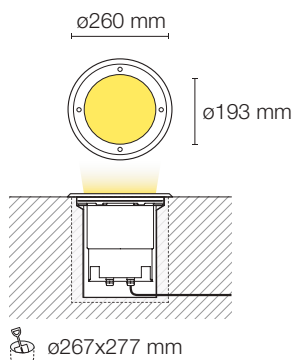



> LANIN 220 IN-GROUND

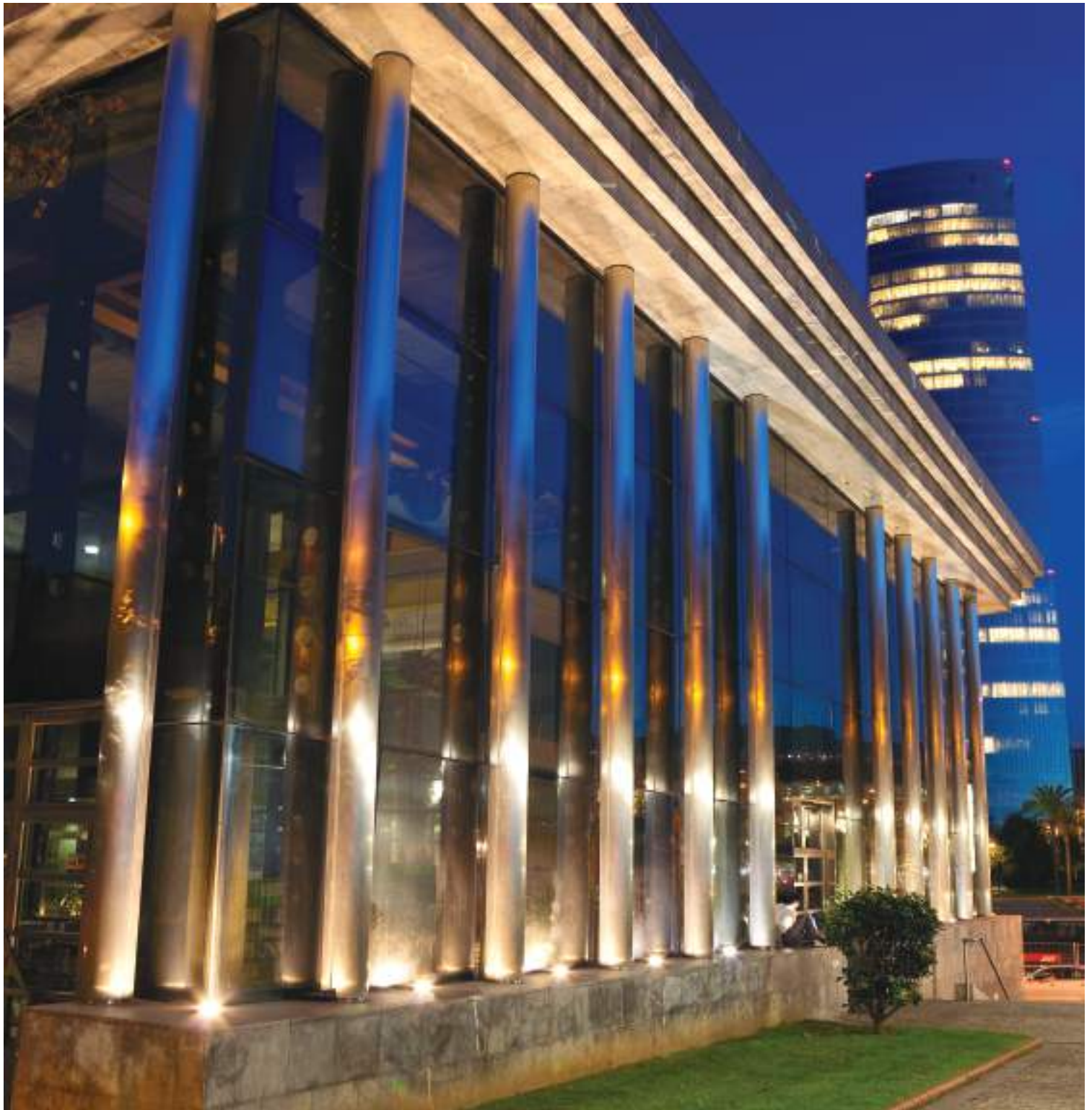

> LANIN 260 IN-GROUND

# GARDEN SPOTLIGHTS







# GARDEN 30 SPOTLIGHTS



## PT

- > Luminária compacta para aplicação no teto, parede ou pavimento em exteriores.
- > Inclinação e rotação ajustáveis para orientação precisa do feixe de luz.
- > Lentes com ângulo de abertura 12°, 35° ou 48° protegidas por vidro temperado transparente.
- > Driver externo de corrente constante e classe proteção II.
- > Pré-cablado com cabo H05RN-F de 5000 mm para facilidade de instalação.
- > Acessórios: Espigão curto ou longo para aplicações de jardim.
- > Corpo em alumínio com tratamento primário anti-corrosão e revestimento a poliéster resistente aos UV.

SHORT SPIKE (OPTION)

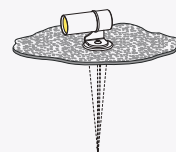

## ES

- > Luminaria compacta para aplicación en exteriores en el techo, pared o en el suelo.
- > Inclinación y rotación ajustables para una orientación precisa del haz de luz
- > Lentes con ángulo de apertura 12°, 35° o 48° protegidas por vidrio templado transparente.
- > Driver externo de corriente constante y clase de protección II.
- > Precableado con cable H05RN-F de 5000 mm para facilidad de instalación.
- > Accesorios: Pica de puesta a tierra corto o largo para aplicaciones de jardín.
- > Cuerpo en aluminio con tratamiento primario anti-corrosión y recubrimiento de poliéster resistente a los UV.

LONG SPIKE (OPTION)

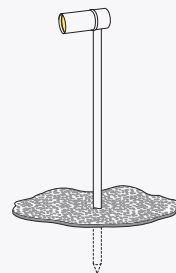

**QUICK INFO**

**GENERAL**

Surface / Wall / Floor  
 IP65  
 IK08  
 960°C  
 Class III  
 Ta= -20°C +40°C

**OPTIC**

Clear Tempered Glass  
 PMMA Lens

**LED**

Efficacy up to 130 lm/W  
 3000 K, 4000 K  
 CRI >80  
 Lifetime 50 000 H  
 L80/B10 @Tc=65°C  
 350 mA, 700 mA

**ELETRICAL SYSTEM**

External Driver  
 230V/50Hz  
 ON/OFF, DALI

**FINISHING**

RAL 9005 Matt Black

**OPTIONS**

**LED**

2700 K, 5000 K, 6500 K

**FINISHING**

 Other Colours

**GARDEN 30 - EXTERNAL DRIVER**

Beam Angle (°)	Output (lm)	LED Power (W)	LED Current	COD
<b>3000 K</b>				
12°	88	1	350 mA	32.WX.012.08.03
	157	2	700 mA	32.WX.017.08.50
35°	80	1	350 mA	32.WX.012.08.04
	142	2	700 mA	32.WX.017.08.51
48°	76	1	350 mA	32.WX.012.08.05
	186	2	700 mA	32.WX.017.08.52
<b>4000 K</b>				
12°	110	1	350 mA	32.WX.012.08.00
	197	2	700 mA	32.WX.017.08.47
35°	100	1	350 mA	32.WX.012.08.01
	178	2	700 mA	32.WX.017.08.48
48°	96	1	350 mA	32.WX.012.08.02
	170	2	700 mA	32.WX.017.08.49

**COMPONENTS**

**DRIVER - EXTERNAL**



CLASS II

ON/OFF	Current	DIMENSION	COD
Power Supply 1-3,6W IP20	350 mA	22x32x76 mm	35.06.20.007004
Power Supply 6-15W IP20	350 mA	31x70x200 mm	35.92.00.000027
Power Supply 2-7W IP20	700 mA	22x32x76 mm	35.92.00.000024
Power Supply 8-18W IP20	700 mA	23x38x125 mm	35.06.60.000661

DALI	Current	DIMENSION	COD
Power Supply 1-13W IP20	350 mA	22x52x111 mm	35.92.00.000025
Power Supply 2-17W IP20	700 mA	22x52x111 mm	35.92.00.000026

> External Driver to be housed nearby.

ROTATION

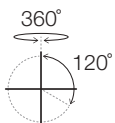

**OPTIONS**

**EARTH SPIKE**

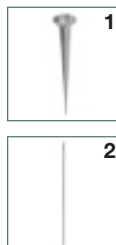

TYPE	FIG	DIMENSION	COD
Short Spike	1	Ø45x175 mm	32.WX.018.08.34
Long Spike	2	Ø12x600 mm	32.WX.018.08.35

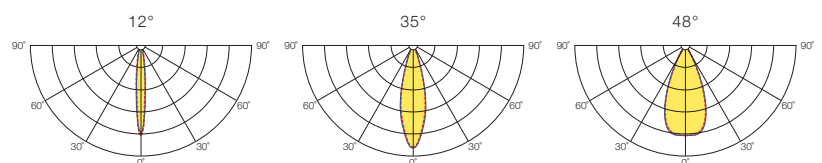
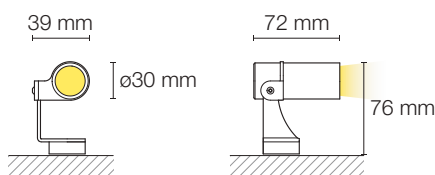

# GARDEN 45 SPOTLIGHTS



## PT

- > Luminária compacta para aplicação no teto, parede ou pavimento em exteriores.
- > Inclinação e rotação ajustáveis para orientação precisa do feixe de luz.
- > Lentes com ângulo de abertura 12°, 35° ou 48° protegidas por vidro temperado transparente.
- > Luminária com fonte de alimentação incorporada.
- > Pré-cabado com cabo H05RN-F de 5000 mm para facilidade de instalação.
- > Acessórios: Espigão curto ou longo para aplicações de jardim.
- > Corpo em alumínio com tratamento primário anti-corrosão e revestimento a poliéster resistente aos UV.

SHORT SPIKE (OPTION)

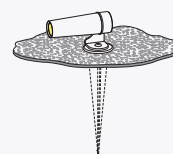

## ES

- > Luminaria compacta para aplicación en exteriores en el techo, pared o en el suelo.
- > Inclinação y rotación ajustables para una orientación precisa del haz de luz
- > Lentes con ángulo de apertura 12°, 35° o 48° protegidas por vidrio templado transparente.
- > Luminaria con alimentación incorporada.
- > Precableado con cable H05RN-F de 5000 mm para facilidad de instalación.
- > Accesorios: Pica de puesta a tierra corto o largo para aplicaciones de jardín.
- > Cuerpo en aluminio con tratamiento primario anti-corrosión y recubrimiento de poliéster resistente a los UV.

LONG SPIKE (OPTION)

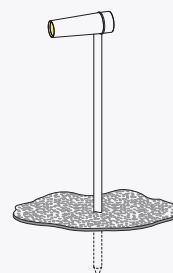

**QUICK INFO**

**GENERAL**

Surface / Wall / Floor  
 IP65  
 IK08  
 960°C  
 Class II  
 Ta= -20°C +40°C

**OPTIC**

Clear Tempered Glass  
 PMMA Lens

**LED**

Efficacy up to 130 lm/W  
 3000 K, 4000 K  
 CRI >80  
 Lifetime 50 000 H  
 L80/B10 @Tc=65°C

**ELETRICAL SYSTEM**

Integrated Driver  
 230V/50Hz  
 ON/OFF

**FINISHING**

RAL 9005 Matt Black

**OPTIONS**

**LED**

2700 K, 5000 K, 6500 K

**FINISHING**

 Other Colours

**GARDEN 45 - INTEGRATED DRIVER**

Beam Angle (°)	Output (lm)	System (W)	COD
<b>3000 K</b>			
12°	84	2	32.WX.013.08.00
	150	4	32.WX.013.08.03
35°	82	2	32.WX.013.08.01
	147	4	32.WX.013.08.04
48°	79	2	32.WX.013.08.02
	137	4	32.WX.013.08.05
<b>4000 K</b>			
12°	105	2	32.WX.013.08.06
	189	4	32.WX.013.08.09
35°	102	2	32.WX.013.08.07
	184	4	32.WX.013.08.10
48°	98	2	32.WX.013.08.08
	171	4	32.WX.013.08.11

**OPTIONS**

**EARTH SPIKE**

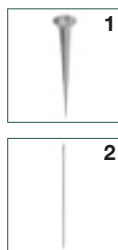

TYPE	FIG	DIMENSION	COD
Short Spike	1	Ø45x175 mm	32.WX.018.08.34
Long Spike	2	Ø12x600 mm	32.WX.018.08.35

**ROTATION**

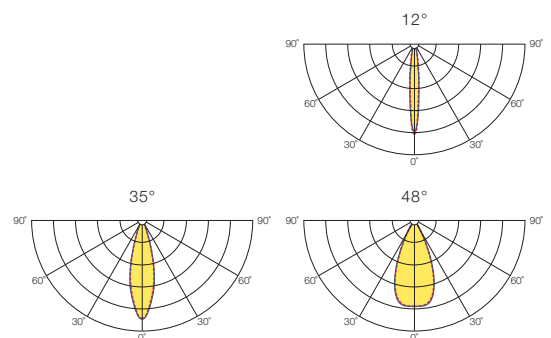
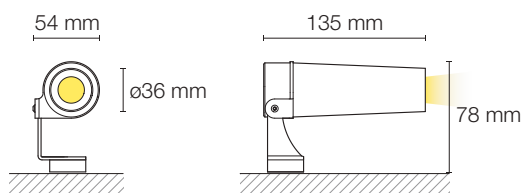
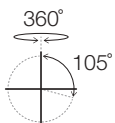

# GARDEN 60 SPOTLIGHTS



## PT

- > Luminária compacta para aplicação no teto, parede ou pavimento em exteriores.
- > Inclinação e rotação ajustáveis para orientação precisa do feixe de luz.
- > Lentes com ângulo de abertura 12°, 35° ou 48° protegidas por vidro temperado transparente.
- > Acessórios óticos: Filtro de controlo encandeamento e viseira cilíndrica anti-encandeamento lateral.
- > Pré-cablado com cabo H05RN-F de 1000 mm para facilidade de instalação.
- > Corpo em alumínio com tratamento primário anti-corrosão e revestimento a poliéster resistente aos UV.

INTEGRATED DRIVER

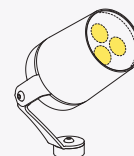

## ES

- > Luminaria compacta para aplicación en exteriores en el techo, pared o en el suelo.
- > Inclinação y rotación ajustables para una orientación precisa del haz de luz
- > Lentes con ángulo de apertura 12°, 35° o 48° protegidas por vidrio templado transparente.
- > Accesorios ópticos: Filtro de control del deslumbramiento y visera cilíndrica anti-deslumbramiento lateral.
- > Precableado con cable H05RN-F de 1000 mm para facilidad de instalación.
- > Cuerpo en aluminio con tratamiento primario anti-corrosión y recubrimiento de poliéster resistente a los UV.

EXTERNAL DRIVER



**QUICK INFO**

**GENERAL**

Surface / Wall / Floor  
 IP65  
 IK08  
 960°C  
 Class I  
 Ta= -20°C +40°C

**OPTIC**

Clear Tempered Glass  
 PMMA Lens

**LED**

Efficacy up to 130 lm/W  
 3000 K, 4000 K  
 CRI >80  
 Lifetime 50 000 H  
 L80/B10 @Tc=65°C

**ELETRICAL SYSTEM**

Integrated Driver  
 230V/50Hz  
 ON/OFF

**FINISHING**

RAL 9005 Matt Black

**OPTIONS**

**LED**

2700 K, 5000 K, 6500 K

**FINISHING**

 Other Colours

**GARDEN 60 - INTEGRATED DRIVER**

Beam Angle (°)	Output (lm)	System (W)	COD
<b>3000 K</b>			
12°	344	4	32.WX.014.08.06
	610	8	32.WX.014.08.09
35°	342	4	32.WX.014.08.07
	602	8	32.WX.014.08.10
48°	322	4	32.WX.014.08.08
	567	8	32.WX.014.08.19
<b>4000 K</b>			
12°	431	4	32.WX.014.08.12
	762	8	32.WX.014.08.15
35°	428	4	32.WX.014.08.13
	752	8	32.WX.014.08.16
48°	403	4	32.WX.014.08.14
	709	8	32.WX.014.08.17

**OPTIONS**

**HONEYCOMB LOUVRE**



TYPE	DIMENSION	COD
Glare Control Filter	ø50 mm	32.WX.000.01.04

**SHIELD**



TYPE	COD
Lateral Glare Control Cylindrical Shield	32.WX.018.08.32

**ROTATION**

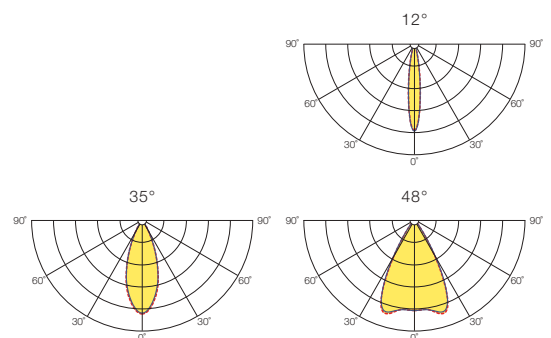
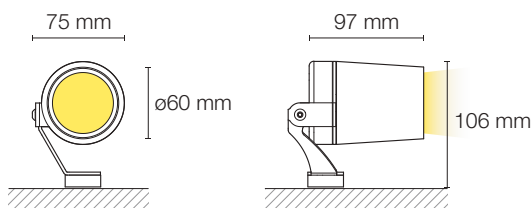
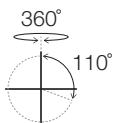

**QUICK INFO**

**GENERAL**

Surface / Wall / Floor  
 IP65  
 IK08  
 960°C  
 Class III  
 Ta= -20°C +40°C

**OPTIC**

Clear Tempered Glass  
 PMMA Lens

**LED**

Efficacy up to 130 lm/W  
 3000 K, 4000 K  
 CRI >80  
 Lifetime 50 000 H  
 L80/B10 @Tc=65°C  
 350 mA, 700 mA

**ELETRICAL SYSTEM**

External Driver  
 230V/50Hz  
 ON/OFF, DALI

**FINISHING**

RAL 9005 Matt Black

**OPTIONS**

**LED**

2700 K, 5000 K, 6500 K

**FINISHING**

Other Colours

**GARDEN 60 - EXTERNAL DRIVER**

Beam Angle (°)	Output (lm)	LED Power (W)	LED Current	COD
<b>3000 K</b>				
12°	344	3	350 mA	32.WX.014.08.00
	610	6,5	700 mA	32.WX.017.08.53
35°	342	3	350 mA	32.WX.014.08.01
	602	6,5	700 mA	32.WX.017.08.54
48°	322	3	350 mA	32.WX.014.08.02
	567	6,5	700 mA	32.WX.017.08.55
<b>4000 K</b>				
12°	431	3	350 mA	32.WX.014.08.03
	762	6,5	700 mA	32.WX.017.08.56
35°	428	3	350 mA	32.WX.014.08.04
	752	6,5	700 mA	32.WX.017.08.57
48°	403	3	350 mA	32.WX.014.08.05
	709	6,5	700 mA	32.WX.017.08.58

**OPTIONS**

**HONEYCOMB LOUVRE**



TYPE	DIMENSION	COD
Glare Control Filter	ø50 mm	32.WX.000.01.04

**SHIELD**



TYPE	COD
Lateral Glare Control Cylindrical Shield	32.WX.018.08.32

**ROTATION**

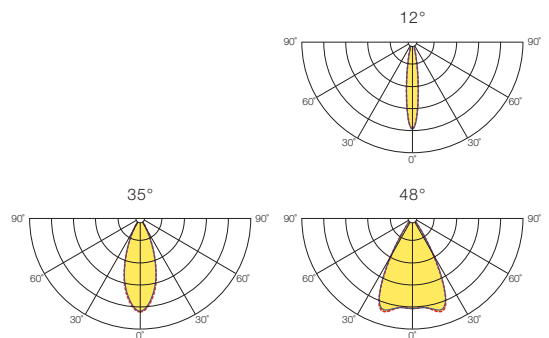
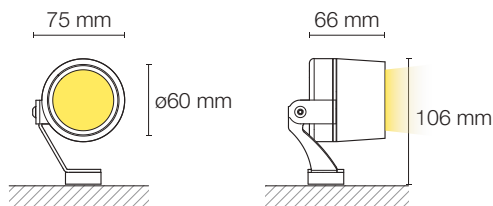
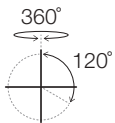



# GARDEN 60

## SPOTLIGHTS

### COMPONENTS



CLASS II

#### DRIVER - EXTERNAL

ON/OFF	Current	DIMENSION	COD
Power Supply 1-3,6W IP20	350 mA	22x32x76 mm	35.06.20.007004
Power Supply 6-15W IP20	350 mA	31x70x200 mm	35.92.00.000027
Power Supply 2-7W IP20	700 mA	22x32x76 mm	35.92.00.000024
Power Supply 8-18W IP20	700 mA	23x38x125 mm	35.06.60.000661

DALI		DIMENSION	COD
Power Supply 1-13W IP20	350 mA	22x52x111 mm	35.92.00.000025
Power Supply 2-17W IP20	700 mA	22x52x111 mm	35.92.00.000026

> External Driver to be housed nearby.



# GARDEN 120

## SPOTLIGHTS



### PT

- > Luminária compacta para aplicação no pavimento ou parede em exteriores.
- > Inclinação e rotação ajustáveis para orientação precisa do feixe de luz.
- > Lentes com ângulo de abertura 12°, 35° ou 48° protegidas por vidro temperado transparente.
- > Acessórios óticos: Filtro de controlo encandeamento e viseira cilíndrica anti-encandeamento lateral.
- > Pré-cablado com cabo H05RN-F de 1000 mm para facilidade de instalação.
- > Corpo em alumínio com tratamento primário anti-corrosão e revestimento a poliéster resistente aos UV.

INTEGRATED DRIVER

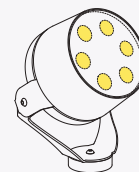

### ES

- > Luminaria compacta para aplicación en exteriores en el suelo o en la pared.
- > Inclinação y rotación ajustables para una orientación precisa del haz de luz
- > Lentes con ángulo de apertura 12°, 35° o 48° protegidas por vidrio templado transparente.
- > Accesorios ópticos: Filtro de control del deslumbramiento y visera cilíndrica anti-deslumbramiento lateral.
- > Precableado con cable H05RN-F de 1000 mm para facilidad de instalación.
- > Cuerpo en aluminio con tratamiento primario anti-corrosión y recubrimiento de poliéster resistente a los UV.

EXTERNAL DRIVER

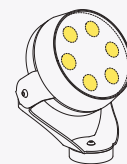

**QUICK INFO**

**GENERAL**

Surface / Wall / Floor  
 IP65  
 IK08  
 960°C  
 Class I  
 Ta= -20°C +40°C

**OPTIC**

Clear Tempered Glass  
 PMMA Lens

**LED**

Efficacy up to 130 lm/W  
 3000 K, 4000 K  
 CRI >80  
 Lifetime 50 000 H  
 L80/B10 @Tc=65°C

**ELETRICAL SYSTEM**

Integrated Driver  
 230V/50Hz  
 ON/OFF

**FINISHING**

RAL 9005 Matt Black

**GARDEN 120 - INTEGRATED DRIVER**

Beam Angle (°)	Output (lm)	System (W)	COD
<b>3000 K</b>			
	946	11	32.WX.015.08.12
12°	1230	14	32.WX.015.08.18
	1580	20	32.WX.015.08.24
35°	908	11	32.WX.015.08.13
	1180	14	32.WX.015.08.19
48°	1516	20	32.WX.015.08.25
	890	11	32.WX.015.08.14
48°	1157	14	32.WX.015.08.20
	1485	20	32.WX.015.08.26
<b>4000 K</b>			
	1135	11	32.WX.015.08.15
12°	1476	14	32.WX.015.08.21
	1896	20	32.WX.015.08.27
35°	1089	11	32.WX.015.08.16
	1417	14	32.WX.015.08.22
48°	1820	20	32.WX.015.08.28
	1067	11	32.WX.015.08.17
48°	1388	14	32.WX.015.08.23
	1784	20	32.WX.015.08.29

**OPTIONS**

**LED**

2700 K, 5000 K, 6500 K

**FINISHING**

 Other Colours

**OPTIONS**

**HONEYCOMB LOUVRE**



TYPE	DIMENSION	COD
Glare Control Filter	ø110 mm	32.WX.000.01.03

**SHIELD**



TYPE	COD
Lateral Glare Control Cylindrical Shield	32.WX.018.08.33

ROTATION

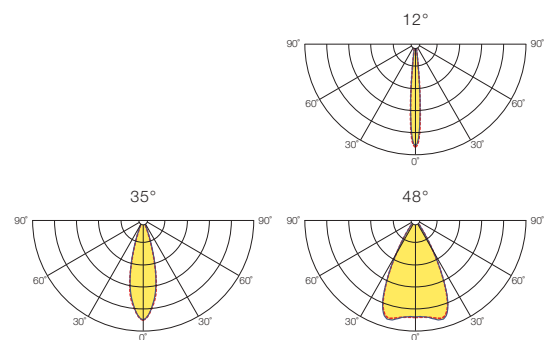
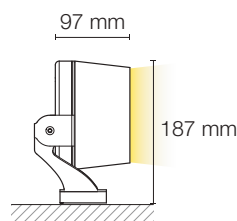
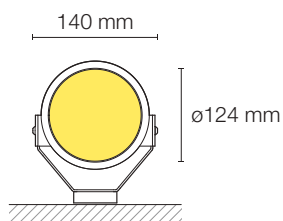
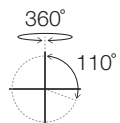

**QUICK INFO**

**GENERAL**

Surface / Wall / Floor  
 IP65  
 IK08  
 960°C  
 Class III  
 Ta= -20°C +40°C

**OPTIC**

Clear Tempered Glass  
 PMMA Lens

**LED**

Efficacy up to 130 lm/W  
 3000 K, 4000 K  
 CRI >80  
 Lifetime 50 000 H  
 L80/B10 @Tc=65°C  
 500 mA, 700 mA

**ELETRICAL SYSTEM**

External Driver  
 230V/50Hz  
 ON/OFF, DALI

**FINISHING**

RAL 9005 Matt Black

**GARDEN 120 - EXTERNAL DRIVER**

Beam Angle (°)	Output (lm)	LED Power (W)	LED Current	COD
<b>3000 K</b>				
	946	9	500 mA	32.WX.015.08.00
12°	1230	14	500 mA	32.WX.015.08.06
	1580	19	700 mA	32.WX.017.08.59
35°	908	9	500 mA	32.WX.015.08.01
	1180	14	500 mA	32.WX.015.08.07
48°	1516	19	700 mA	32.WX.017.08.60
	890	9	500 mA	32.WX.015.08.02
48°	1157	14	500 mA	32.WX.015.08.08
	1485	19	700 mA	32.WX.017.08.61
<b>4000 K</b>				
	1135	9	500 mA	32.WX.015.08.03
12°	1476	14	500 mA	32.WX.015.08.09
	1896	19	700 mA	32.WX.017.08.62
35°	1089	9	500 mA	32.WX.015.08.04
	1417	14	500 mA	32.WX.015.08.10
48°	1820	19	700 mA	32.WX.017.08.63
	1067	9	500 mA	32.WX.015.08.05
48°	1388	14	500 mA	32.WX.015.08.11
	1784	19	700 mA	32.WX.017.08.64

**OPTIONS**

**LED**

2700 K, 5000 K, 6500 K

**FINISHING**

 Other Colours

**OPTIONS**

**HONEYCOMB LOUVRE**



TYPE	DIMENSION	COD
Glare Control Filter	ø110 mm	32.WX.000.01.03

**SHIELD**



TYPE	COD
Lateral Glare Control Cylindrical Shield	32.WX.018.08.33

**ROTATION**

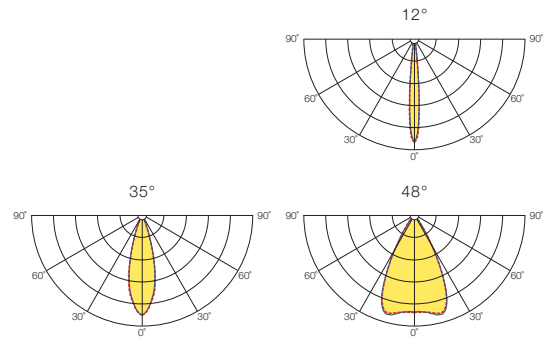
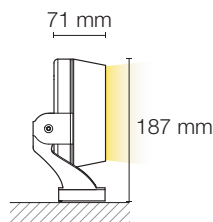
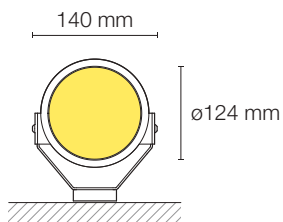
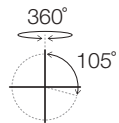

# GARDEN 120

## SPOTLIGHTS

### COMPONENTS



CLASS II

#### DRIVER - EXTERNAL

ON/OFF	Current	DIMENSION	COD
Power Supply 9-15W IP20	500 mA	31x70x200 mm	35.92.00.000028
Power Supply 12-22W IP20	500 mA	31x70x200 mm	35.92.003.01.09
Power Supply 19-31W IP20	500 mA	34x82x160 mm	35.92.003.01.22
Power Supply 17-22W IP20	700 mA	31x70x200 mm	35.92.00.000029
DALI		DIMENSION	COD
Power Supply 9-15W IP20	500 mA	31x70x200 mm	35.92.00.000031
Power Supply 12-22W IP20	500 mA	31x70x200 mm	35.92.003.01.12
Power Supply 17-22W IP20	700 mA	31x70x200 mm	35.92.00.000032

> External Driver to be housed nearby.



**I-SPOT RO IP65**  
DOWNLIGHTS





> **I-SPOT RO IP65** DOWNLIGHTS

# I-SPOT RO IP65

## DOWNLIGHTS



### PT

- > Downlight com elevado grau de proteção para aplicação em exteriores.
- > Índice de proteção IP65 após instalação.
- > Formato tubular disponível em três diâmetros distintos.
- > Difusor de proteção em vidro temperado.
- > Corpo em alumínio com tratamento primário anti-corrosão e revestimento a poliéster resistente aos UV.

### ES

- > Downlight con elevado grado de protección para aplicación en exteriores.
- > Grado de protección IP65 después de la instalación.
- > Formato tubular disponible en tres diámetros.
- > Difusor de protección en vidrio templado.
- > Cuerpo en aluminio con tratamiento primario anti-corrosión y recubrimiento de poliéster resistente a los UV.



**QUICK INFO**

**GENERAL**

Surface  
IP65  
IK08  
960°C  
Class I  
Ta= -20°C +40°C

**OPTIC**

Clear Tempered Glass  
Anodized Aluminium Reflector

**LED**

Efficacy up to 95 lm/W  
3000 K, 4000 K  
CRI >80  
Lifetime 50 000 H  
L80/B10@Tc=65°C

**ELETRICAL SYSTEM**

230V/50Hz  
ON/OFF

**FINISHING**

RAL 9003 Matt White

**OPTIONS**

**LED**

2700 K, 5000 K  
CRI >90

**FINISHING**

 Other Colours

**I-SPOT RO IP65**

Ø (mm)	Beam Angle (°)	Output (lm)	System (W)	COD
<b>3000 K</b>				
100	14°	640	10	32.WX.015.08.85
	24°	645	10	32.WX.015.08.86
	50°	631	10	32.WX.015.08.87
120	14°	1355	20	32.WX.015.08.91
	24°	1364	20	32.WX.015.08.92
	45°	1338	20	32.WX.015.08.93
150	20°	2035	30	32.WX.015.08.97
	28°	2050	30	32.WX.015.08.98
	50°	2010	30	32.WX.015.08.99
<b>4000 K</b>				
100	14°	715	10	32.WX.016.08.04
	24°	720	10	32.WX.016.08.05
	50°	705	10	32.WX.016.08.06
120	14°	1465	20	32.WX.016.08.10
	24°	1440	20	32.WX.016.08.11
	45°	1415	20	32.WX.016.08.12
150	20°	2150	30	32.WX.016.08.16
	28°	2170	30	32.WX.016.08.17
	50°	2125	30	32.WX.016.08.18

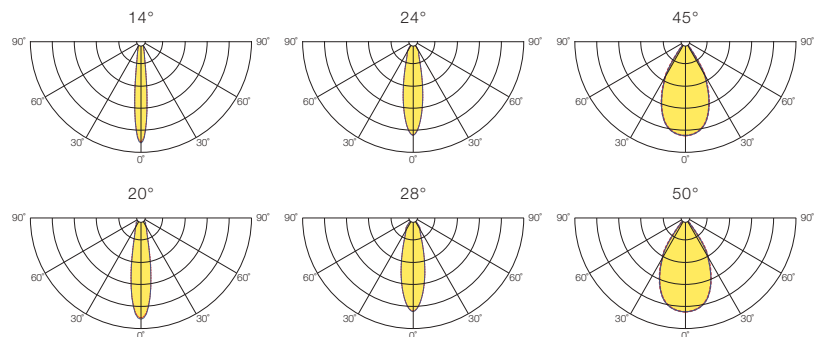

I-SPOT RO 100

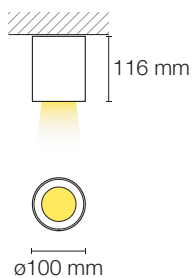

I-SPOT RO 120

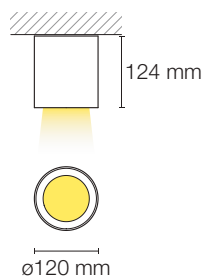

I-SPOT RO 150

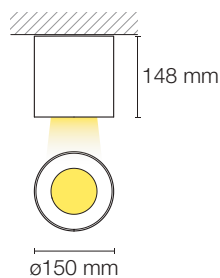

**I-SPOT SQ IP54**  
DOWNLIGHTS





# I-SPOT SQ IP54 DOWNLIGHTS



## PT

- > Downlight para aplicação saliente em exteriores.
- > Índice de proteção IP54 e resistência a impactos IK08.
- > Difusor de proteção em vidro temperado.
- > Corpo em alumínio com tratamento primário anti-corrosão e revestimento a poliéster resistente aos UV.

## ES

- > Downlight para aplicación adosada a techo en exteriores.
- > Grado de protección IP54 y resistencia a los impactos IK08.
- > Difusor de protección en vidrio templado.
- > Cuerpo en aluminio con tratamiento primario anti-corrosión y recubrimiento de poliéster resistente a los UV.

**QUICK INFO**

**GENERAL**

Surface  
 IP54  
 IK08  
 960°C  
 Class I  
 Ta= -20°C +40°C

**OPTIC**

Clear Tempered Glass

**LAMP** - NOT INCLUDED  
 GU10

**ELETRICAL SYSTEM**

230V/50Hz  
 ON/OFF

**FINISHING**

RAL 9003 Matt White  
 Metallic Textured Grey

**OPTIONS**

**FINISHING**

 Other Colours

**I-SPOT SQ IP54 - LAMP**

Type	LAMP Power (W)	MATT WHITE	METALLIC GREY
<b>IP54</b>			
GU10	max. 50	32.WX.018.08.36	32.WX.018.08.37

> Lamp not included.

**RECOMENDED LAMPS**



**OSRAM**  
 PARATHOM  
 PAR 16  
 GU10  
 6,9 W



**PHILIPS**  
 Corepro  
 LEDspot  
 GU10  
 7 W

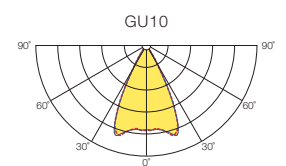
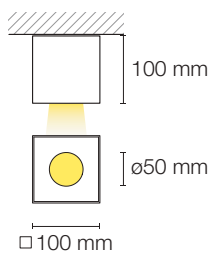

Lamp: 10W (GU10).

# I-SPOT RO IP54 DOWNLIGHTS



## PT

- > Downlight para aplicação saliente em exteriores.
- > Índice de proteção IP54 e resistência a impactos IK08.
- > Difusor de proteção em vidro temperado.
- > Corpo em alumínio com tratamento primário anti-corrosão e revestimento a poliéster resistente aos UV.

## ES

- > Downlight para aplicación adosada a techo en exteriores.
- > Grado de protección IP54 y resistencia a los impactos IK08.
- > Difusor de protección en vidrio templado.
- > Cuerpo en aluminio con tratamiento primario anti-corrosión y recubrimiento de poliéster resistente a los UV.

**QUICK INFO**

**GENERAL**

Surface  
 IP54  
 IK08  
 960°C  
 Class I  
 Ta= -20°C +40°C

**OPTIC**

Clear Tempered Glass

**LAMP - NOT INCLUDED**

GU10

**ELETRICAL SYSTEM**

230V/50Hz  
 ON/OFF

**FINISHING**

RAL 9003 Matt White  
 Metallic Textured Grey

**OPTIONS**

**FINISHING**

 Other Colours

**I-SPOT RO IP54 - LAMP**

Type	LAMP Power (W)	MATT WHITE	METALLIC GREY
<b>IP54</b>			
GU10	max. 50	32.WX.015.08.81	32.WX.018.08.08

> Lamp not included.

**RECOMENDED LAMPS**



**OSRAM**  
 PARATHOM  
 PAR 16  
 GU10  
 6,9 W



**PHILIPS**  
 Corepro  
 LEDspot  
 GU10  
 7 W

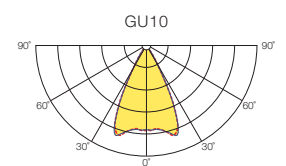
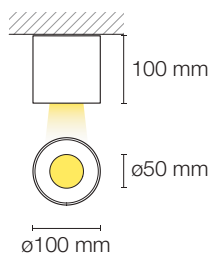

Lamp: 10W (GU10).

**BRICK FLOOD  
WALL**







> BRICK FLOOD WALL

# BRICK WALL



## PT

- > Luminária de encastrar na parede com sistema ótico multi-lente de alto desempenho.
- > Para iluminação em entradas, escadarias e rampas de acesso em interiores e exteriores.
- > Em versões com distribuição de luz assimétrica (H e V) ou com emissão difusa (Flood).
- > Luminária com fonte de alimentação incorporada.
- > Pré-cablado com cabo H05RN-F de 500 mm para facilidade de instalação.
- > Inclui caixa de embutir em alumínio.
- > Frente em aço inox AISI 316.

## ES

- > Luminaria para empotrar en la pared con sistema óptico multi-lente de alto rendimiento.
- > Para la iluminación de entradas, escaleras y rampas en zonas exteriores e interiores.
- > Versiones con distribución de luz asimétrica (H y V) o con emisión difusa (Flood).
- > Luminaria con alimentación incorporada.
- > Precableado con cable H05RN-F de 500 mm para facilidad de instalación.
- > Incluye caja de empotramiento en aluminio.
- > Marco frontal en acero inoxidable AISI 316.

**QUICK INFO**

**GENERAL**

Wall  
 IP65  
 IK10  
 960°C  
 Class I  
 Ta= -20°C +40°C

**OPTIC**

Opal Tempered Glass

**LED**

Efficacy up to 130 lm/W  
 3000 K, 4000 K  
 CRI >80  
 Lifetime 50 000 H  
 L80/B10 @Tc=65°C

**ELETRICAL SYSTEM**

230V/50Hz  
 ON/OFF

**FINISHING**

Fine Brushed Stainless Steel  
 Metallic Textured Grey  
 RAL 9003 Matt White  
 RAL 9005 Matt Black

**OPTIONS**

**FINISHING**

 Other Colours

**BRICK FLOOD  
 OPAL GLASS**

**FINE BRUSHED STAINLESS STEEL FINISHING**

Output (lm)	System (W)	COD
<b>3000 K</b>		
81	4	32.WX.016.08.26
<b>4000 K</b>		
97	4	32.WX.016.08.27

**METALLIC TEXTURED GREY FINISHING**

Output (lm)	System (W)	COD
<b>3000 K</b>		
81	4	32.WX.018.08.64
<b>4000 K</b>		
97	4	32.WX.018.08.65

**MATT WHITE FINISHING**

Output (lm)	System (W)	COD
<b>3000 K</b>		
81	4	32.WX.018.08.52
<b>4000 K</b>		
97	4	32.WX.018.08.53

**MATT BLACK FINISHING**

Output (lm)	System (W)	COD
<b>3000 K</b>		
81	4	32.WX.018.08.58
<b>4000 K</b>		
97	4	32.WX.018.08.59

**HORIZONTAL**

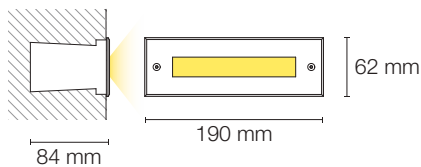

**VERTICAL**

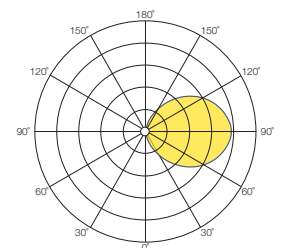
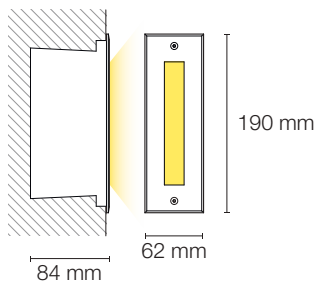

**QUICK INFO**

**GENERAL**

Wall  
 IP65  
 IK10  
 960°C  
 Class I  
 Ta= -20°C +40°C

**OPTIC**

Clear Tempered Glass  
 PMMA Lens

**LED**

Efficacy up to 130 lm/W  
 3000 K, 4000 K  
 CRI >80  
 Lifetime 50 000 H  
 L80/B10 @TC=65°C

**ELETRICAL SYSTEM**

230V/50Hz  
 ON/OFF

**FINISHING**

Fine Brushed Stainless Steel  
 Metallic Textured Grey  
 RAL 9003 Matt White  
 RAL 9005 Matt Black

**OPTIONS**

**FINISHING**

 Other Colours

**BRICK H  
 CLEAR GLASS**

**FINE BRUSHED STAINLESS STEEL FINISHING**

Output (lm)	System (W)	COD
<b>3000 K</b>		
116	4	32.WX.016.08.28
<b>4000 K</b>		
139	4	32.WX.016.08.29

**METALLIC TEXTURED GREY FINISHING**

Output (lm)	System (W)	COD
<b>3000 K</b>		
116	4	32.WX.018.08.66
<b>4000 K</b>		
139	4	32.WX.018.08.67

**MATT WHITE FINISHING**

Output (lm)	System (W)	COD
<b>3000 K</b>		
116	4	32.WX.018.08.54
<b>4000 K</b>		
139	4	32.WX.018.08.55

**MATT BLACK FINISHING**

Output (lm)	System (W)	COD
<b>3000 K</b>		
116	4	32.WX.018.08.60
<b>4000 K</b>		
139	4	32.WX.018.08.61

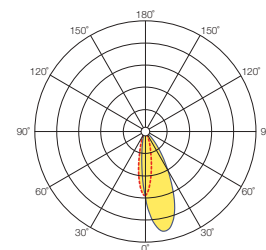
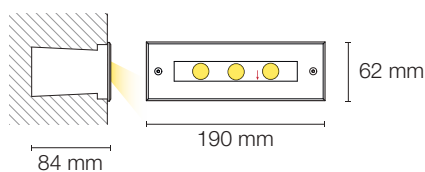

**QUICK INFO****GENERAL**

Wall  
 IP65  
 IK10  
 960°C  
 Class I  
 Ta= -20°C +40°C

**OPTIC**

Clear Tempered Glass  
 PMMA Lens

**LED**

Efficacy up to 130 lm/W  
 3000 K, 4000 K  
 CRI >80  
 Lifetime 50 000 H  
 L80/B10 @Tc=65°C

**ELETRICAL SYSTEM**

230V/50Hz  
 ON/OFF

**FINISHING**

Fine Brushed Stainless Steel  
 Metallic Textured Grey  
 RAL 9003 Matt White  
 RAL 9005 Matt Black

**OPTIONS****FINISHING**

 Other Colours

**BRICK V  
 CLEAR GLASS****FINE BRUSHED STAINLESS STEEL FINISHING**

Output (lm)	System (W)	COD
<b>3000 K</b>		
120	4	32.WX.016.08.30
<b>4000 K</b>		
144	4	32.WX.016.08.31

**METALLIC TEXTURED GREY FINISHING**

Output (lm)	System (W)	COD
<b>3000 K</b>		
120	4	32.WX.018.08.68
<b>4000 K</b>		
144	4	32.WX.018.08.69

**MATT WHITE FINISHING**

Output (lm)	System (W)	COD
<b>3000 K</b>		
120	4	32.WX.018.08.56
<b>4000 K</b>		
144	4	32.WX.018.08.57

**MATT BLACK FINISHING**

Output (lm)	System (W)	COD
<b>3000 K</b>		
120	4	32.WX.018.08.62
<b>4000 K</b>		
144	4	32.WX.018.08.63

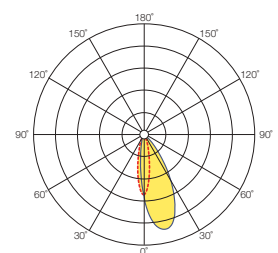
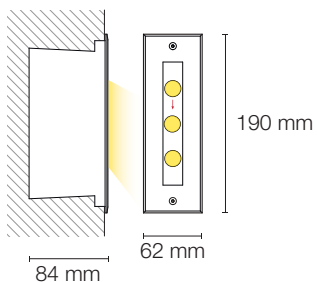

**ODL-302**  
WALL

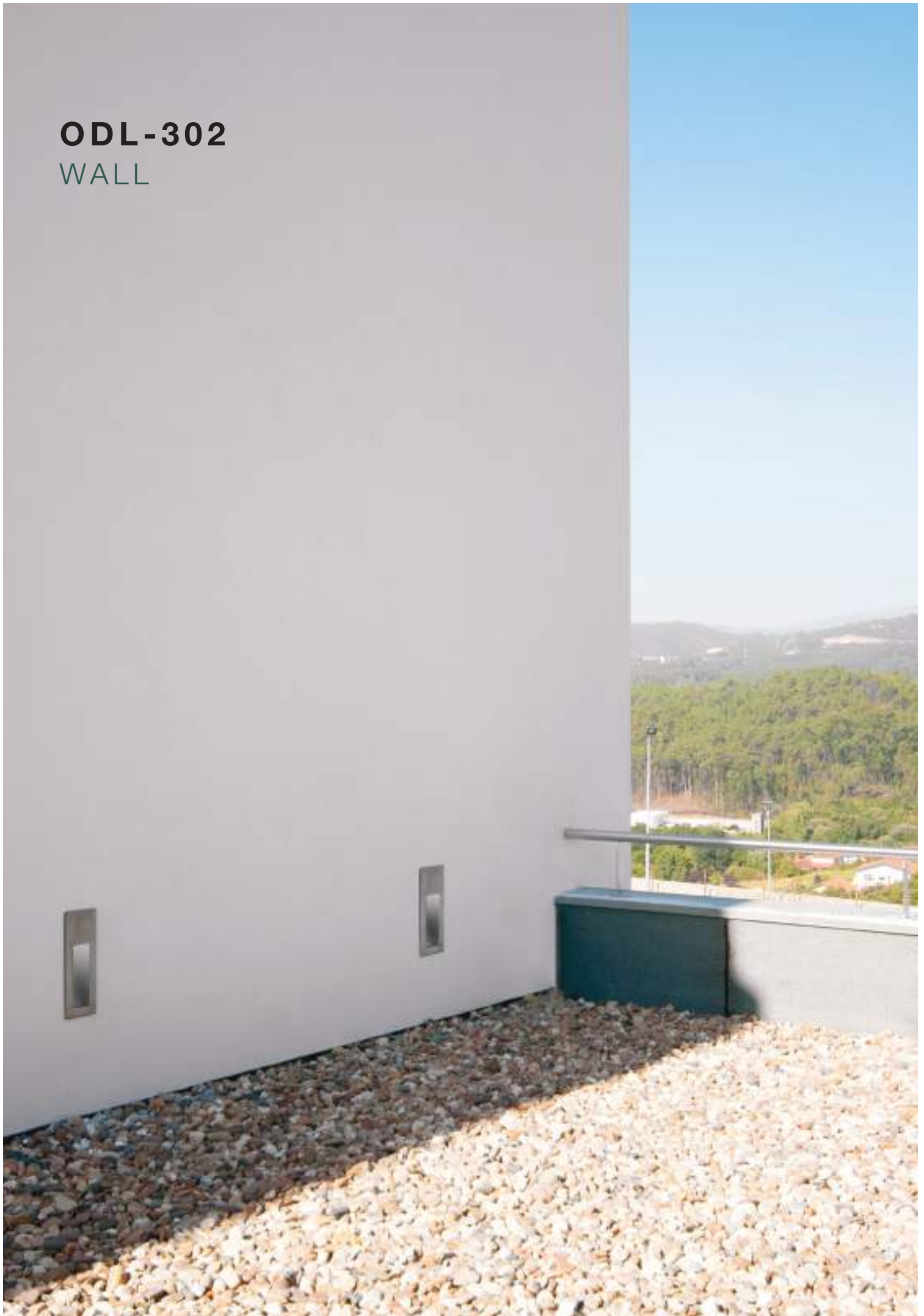

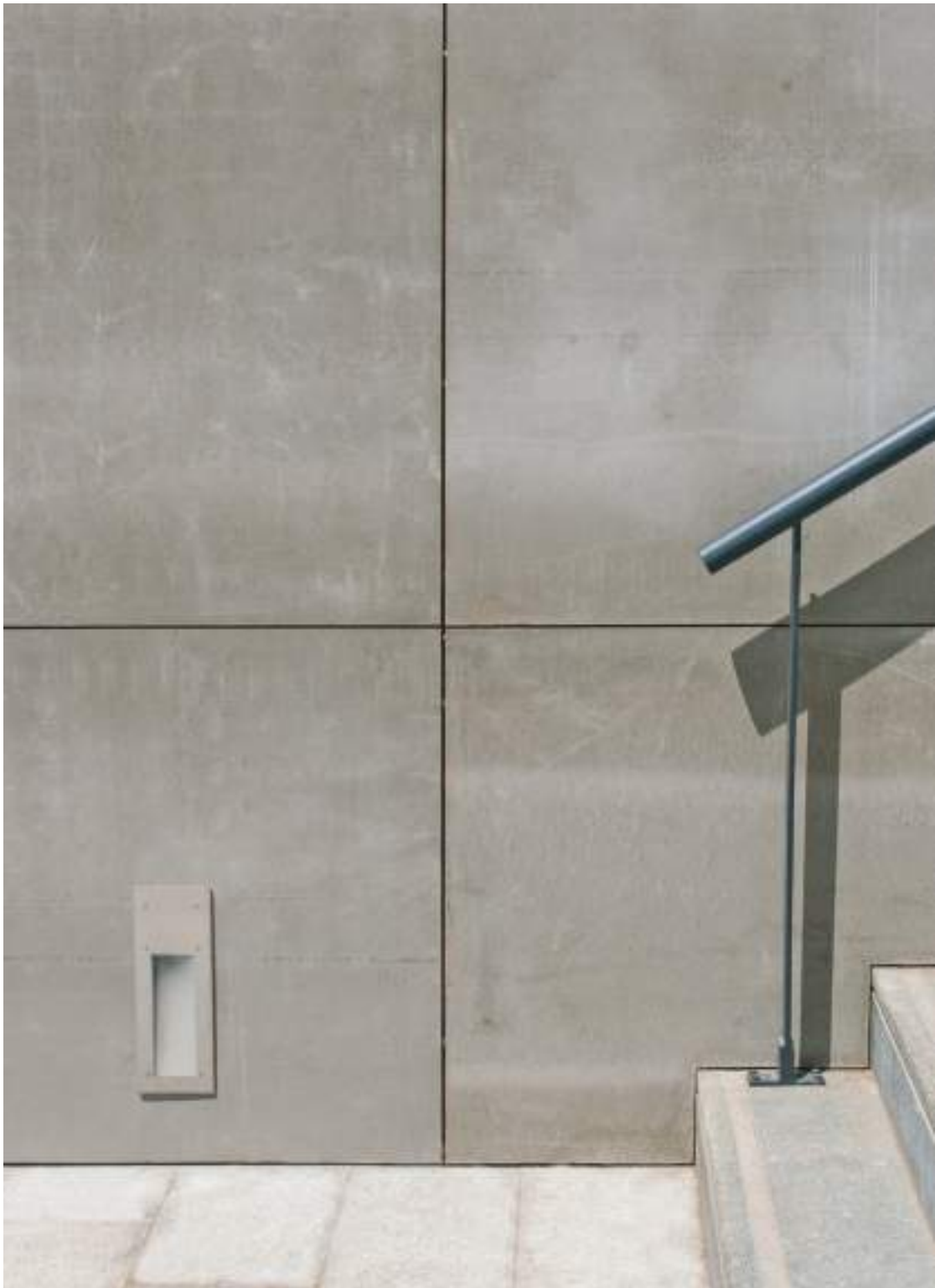

> ODL-302 WALL

# ODL-302

## WALL



### PT

- > Luminária com distribuição de luz assimétrica para aplicação encastrada na parede
- > Para iluminação em entradas, escadarias e rampas de acesso em interiores e exteriores.
- > Corpo compacto com fonte de alimentação incorporada.
- > Pré-cablado com cabo H05RN-F de 500 mm para rapidez e facilidade de instalação.
- > Inclui caixa de embutir em chapa de aço com revestimento em poliéster.
- > Refletor em alumínio anodizado.
- > Frente em aço inox AISI 316 ou em alumínio com tratamento primário anti-corrosão e revestimento a poliéster resistente aos UV.

### ES

- > Luminaria con distribución de luz asimétrica para instalación empotrada en la pared.
- > Para la iluminación de entradas, escaleras y rampas en zonas exteriores e interiores.
- > Cuerpo compacto con fuente de alimentación incorporada.
- > Precableado con cable H05RN-F de 500 mm para una instalación rápida y fácil.
- > Incluye caja de empotramiento en chapa de acero con recubrimiento de poliéster.
- > Reflector en aluminio anodizado.
- > Marco frontal en acero inoxidable AISI 316 o en aluminio con tratamiento primario anti-corrosión y recubrimiento de poliéster resistente a los UV.



**QUICK INFO****GENERAL**

Wall  
 IP54  
 IK07  
 960°C  
 Class I  
 Ta= -20°C +40°C

**OPTIC**

Anodized Aluminium Reflector  
 Clear Tempered Glass

**LED**

Efficacy up to 99 lm/W  
 3000 K, 4000 K  
 CRI >80  
 Lifetime 50 000 H  
 L70/B10 @Tc=65°C

**ELETRICAL SYSTEM**

230V/50Hz  
 ON/OFF

**FINISHING**

Fine Brushed Stainless Steel  
 Metallic Textured Grey  
 RAL 9003 Matt White  
 RAL 9005 Matt Black

**OPTIONS****LED**

2700 K, 5000 K, 6500 K

**FINISHING**

 Other Colours

**OLD-302****FINE BRUSHED STAINLESS STEEL FINISHING**

Output (lm)	System (W)	COD
<b>3000 K</b>		
34	5,5	32.WX.016.08.23
<b>4000 K</b>		
34	5,5	32.WX.016.08.25

**METALLIC TEXTURED GREY FINISHING**

Output (lm)	System (W)	COD
<b>3000 K</b>		
34	5,5	32.WX.016.08.22
<b>4000 K</b>		
34	5,5	32.WX.016.08.24

**MATT WHITE FINISHING**

Output (lm)	System (W)	COD
<b>3000 K</b>		
34	5,5	32.WX.018.08.44
<b>4000 K</b>		
34	5,5	32.WX.018.08.46

**MATT BLACK FINISHING**

Output (lm)	System (W)	COD
<b>3000 K</b>		
34	5,5	32.WX.018.08.45
<b>4000 K</b>		
34	5,5	32.WX.018.08.47

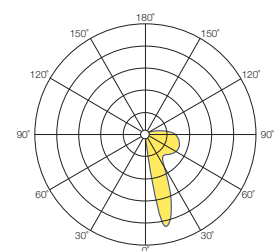
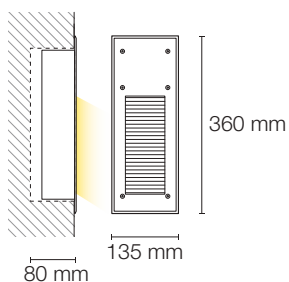

# ODL-302 SQ

## WALL



### PT

- > Luminária com distribuição de luz assimétrica para aplicação encastrada na parede
- > Para iluminação em entradas, escadarias e rampas de acesso em interiores e exteriores.
- > Corpo compacto com fonte de alimentação.
- > Pré-cablado com cabo H05RN-F de 500 mm para rapidez e facilidade de instalação.
- > Inclui caixa de embutir em plástico.
- > Difusor de proteção em vidro temperado.
- > Frente em alumínio com tratamento primário anti-corrosão e revestimento a poliéster resistente aos UV.

### ES

- > Luminaria con distribución de luz asimétrica para instalación empotrada en la pared.
- > Para la iluminación de entradas, escaleras y rampas en zonas exteriores e interiores.
- > Cuerpo compacto con fuente de alimentación incorporada.
- > Precableado con cable H05RN-F de 500 mm para una instalación rápida y fácil.
- > Incluye caja de empotramiento de plástico.
- > Difusor de protección en vidrio templado.
- > Marco frontal en aluminio con tratamiento primario anti-corrosión y recubrimiento de poliéster resistente a los UV.

**QUICK INFO****GENERAL**

Wall  
 IP65  
 IK10  
 960°C  
 Class I  
 Ta= -20°C +40°C

**OPTIC**

Clear Tempered Glass  
 PMMA Lens

**LED**

Efficacy up to 130 lm/W  
 3000 K, 4000 K  
 CRI >80  
 Lifetime 50 000 H  
 L80/B10 @Tc=65°C

**ELETRICAL SYSTEM**

230V/50Hz  
 ON/OFF

**FINISHING**

Metallic Textured Grey  
 RAL 9003 Matt White  
 RAL 9005 Matt Black

**ODL-302 SQ****METALLIC TEXTURED GREY FINISHING**

Output (lm)	System (W)	COD
<b>3000 K</b>		
116	6	32.WX.018.08.38
<b>4000 K</b>		
145	6	32.WX.016.08.21

**MATT WHITE FINISHING**

Output (lm)	System (W)	COD
<b>3000 K</b>		
116	6	32.WX.018.08.48
<b>4000 K</b>		
145	6	32.WX.018.08.49

**MATT BLACK FINISHING**

Output (lm)	System (W)	COD
<b>3000 K</b>		
116	6	32.WX.018.08.50
<b>4000 K</b>		
145	6	32.WX.018.08.51

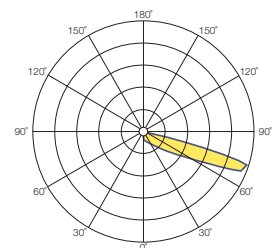
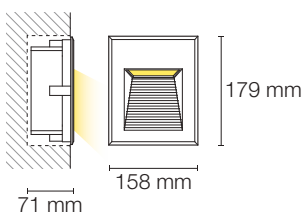



> DOUBLE MONO LD/LI WALL



> **DOUBLE MONO LD/LI WALL**

# DOUBLE MONO DIRECT OR INDIRECT LIGHT WALL



## PT

- > Aplique de parede com design simples e minimalista para aplicação em exterior.
- > Disponível com emissão de luz direta, indireta e direta/indireta em simultâneo.
- > Índice de proteção IP65 e resistência a impactos IK07.
- > Difusor de proteção em vidro temperado.
- > Corpo em alumínio com tratamento primário anti-corrosão e revestimento a poliéster resistente aos UV.

## ES

- > Aplique de pared de diseño sencillo y minimalista para aplicación en exteriores.
- > Disponible con emisión de luz directa, indirecta y directa/indirecta simultánea.
- > Grado de protección IP65 y resistencia a los impactos IK07.
- > Difusor de protección en vidrio templado.
- > Cuerpo en aluminio con tratamiento primario anti-corrosión y recubrimiento de poliéster resistente a los UV.

DIRECT & INDIRECT LIGHT



DIRECT OR INDIRECT LIGHT

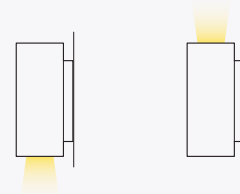

**QUICK INFO**

**GENERAL**

Wall  
 IP65  
 IK07  
 960°C  
 Class I  
 Ta= -20°C +40°C

**OPTIC**

Clear Tempered Glass

**LAMP - NOT INCLUDED**

GU10

**ELETRICAL SYSTEM**

230V/50Hz  
 ON/OFF  
 Direct / Indirect - Simultaneous Control

**FINISHING**

Metallic Textured Grey  
 RAL 9003 Matt White  
 RAL 9005 Matt Black

**OPTIONS**

**FINISHING**

 Other Colours

**DOUBLE MONO**

**LD/LI - DIRECT & INDIRECT LIGHT**

Type	LAMP Power (W)	GREY	WHITE	BLACK
<b>IP65</b>				
GU10	max. 2x35	32.WX.016.08.33	32.WX.018.08.71	32.WX.018.08.73

> Lamp not included.

**LD - DIRECT LIGHT OR LI - INDIRECT LIGHT**

Type	LAMP Power (W)	GREY	WHITE	BLACK
<b>IP65</b>				
GU10	max. 35	32.WX.016.08.32	32.WX.018.08.70	32.WX.018.08.72

> Lamp not included.

**RECOMENDED LAMPS**



**OSRAM**  
 PARATHOM  
 PAR 16  
 GU10  
 6,9 W



**PHILIPS**  
 Corepro  
 LEDspot  
 GU10  
 7 W

LD/LI

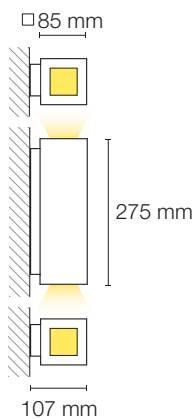

LD OR LI

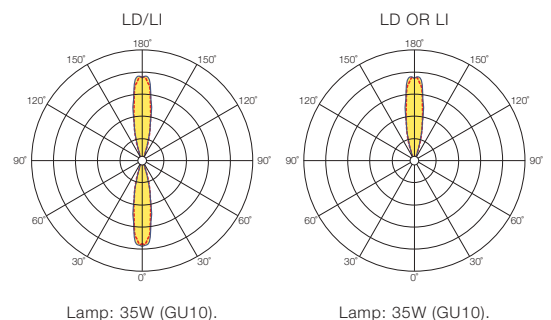
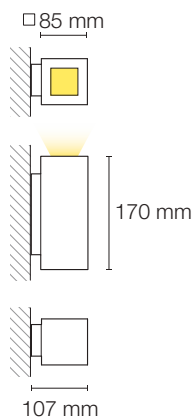

**NIMIX**  
WALLWASHER





Hotel Meliá Ría



# NIMIX

## WALLWASHER



### PT

- > Luminária linear compacta com fonte de alimentação incorporada para iluminação de fachadas ou efeitos de luz.
- > Três opções de lente – ângulo de abertura 9°, 32° ou 14°x34°.
- > Ângulo de inclinação ajustável em 180° em incrementos de 7,5°.
- > Possibilidade de instalação lado a lado para um feixe de luz uniforme.
- > Pré-cablado com dois cabos de 300 mm e ligadores rápidos que permitem a repicagem.
- > Compartimento ótico protegido por difusor em vidro temperado.
- > Corpo em alumínio com acabamento anodizado mate.

### ES

- > Luminaria compacta con alimentación incorporada para una iluminación de fachadas o efectos de luz.
- > Tres opciones de lente – ángulo de apertura 9°, 32° o 14°x34°.
- > Ángulo de inclinación ajustable en 180° en incrementos de 7,5°.
- > Posibilidad de instalación lado a lado para un haz de luz uniforme.
- > Precableado con dos cables de 300 mm y conectores rápidos para cableado de paso.
- > Grupo óptico protegido por difusor en vidrio templado.
- > Cuerpo en aluminio con acabado anodizado mate.

**QUICK INFO**

**GENERAL**

Surface / Wall / Floor  
 IP65  
 IK09  
 960°C  
 Class I  
 Ta= -20°C +35°C

**OPTIC**

Clear Tempered Glass

**LED**

Efficacy up to 133 lm/W  
 3000 K  
 CRI >80  
 Lifetime 50 000 H  
 L80/B10 @Tc=65°C

**ELETRICAL SYSTEM**

230V/50Hz  
 ON/OFF / DALI

**FINISHING**

Matt Anodized Aluminium

**OPTIONS**

**LED**

2700 K, 5000 K, 6500 K  
 Tunable White, RGB, RGBW  
 CRI >90

**ELECTRICAL SYSTEM**

DSI, DIM 1-10V, Phase-cut

**CONTROL SYSTEM**

DMX

**NIMIX**

Beam Angle (°)	c (mm)	Output (lm)	System (W)	ON/OFF	DALI
<b>3000 K</b>					
9°	380	527	7	32.WX.016.08.34	32.WX.016.08.83
		715	10	32.WX.016.08.35	32.WX.016.08.84
	680	1055	13	32.WX.016.08.36	32.WX.016.08.85
		1430	20	32.WX.016.08.37	32.WX.016.08.86
	980	1582	20	32.WX.016.08.38	32.WX.016.08.87
		2145	30	32.WX.016.08.39	32.WX.016.08.88
32°	1280	2110	27	32.WX.016.08.40	32.WX.016.08.89
		2860	40	32.WX.016.08.41	32.WX.016.08.90
	380	483	7	32.WX.016.08.42	32.WX.016.08.91
		656	10	32.WX.016.08.43	32.WX.016.08.92
	680	966	13	32.WX.016.08.44	32.WX.016.08.93
		1312	20	32.WX.016.08.45	32.WX.016.08.94
Elliptical 14°x34°	980	1449	20	32.WX.016.08.46	32.WX.016.08.95
		1968	30	32.WX.016.08.47	32.WX.016.08.96
	1280	1932	27	32.WX.016.08.48	32.WX.016.08.97
		2623	40	32.WX.016.08.49	32.WX.016.08.98
	380	651	7	32.WX.016.08.50	32.WX.016.08.99
		929	10	32.WX.016.08.51	32.WX.017.08.01
680	1301	13	32.WX.016.08.52	32.WX.017.08.02	
	1857	20	32.WX.016.08.53	32.WX.017.08.03	
980	1857	20	32.WX.016.08.54	32.WX.017.08.04	
	2786	30	32.WX.016.08.55	32.WX.017.08.05	
1280	2602	27	32.WX.016.08.56	32.WX.017.08.06	
	3715	40	32.WX.016.08.57	32.WX.017.08.07	

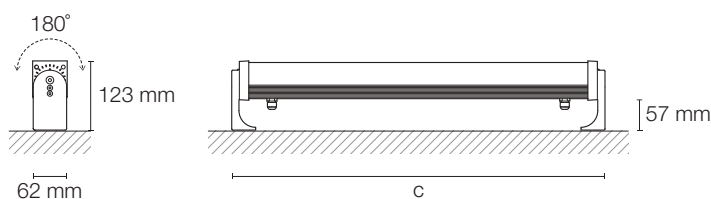
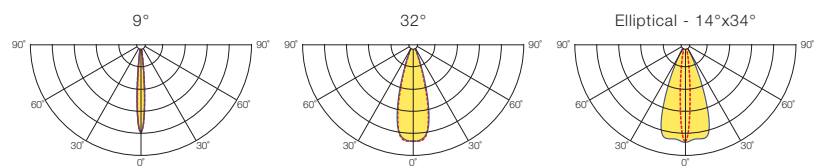

**QUICK INFO**

**GENERAL**

Surface / Wall / Floor  
 IP65  
 IK09  
 960°C  
 Class I  
 Ta= -20°C +35°C

**OPTIC**

Clear Tempered Glass

**LED**

Efficacy up to 147 lm/W  
 4000 K  
 CRI >80  
 Lifetime 50 000 H  
 L80/B10 @Tc=65°C

**ELETRICAL SYSTEM**

230V/50Hz  
 ON/OFF / DALI

**FINISHING**

Matt Anodized Aluminium

**OPTIONS**

**LED**

2700 K, 5000 K, 6500 K  
 Tunable White, RGB, RGBW  
 CRI >90

**ELECTRICAL SYSTEM**

DSI, DIM 1-10V, Phase-cut

**CONTROL SYSTEM**

DMX

**NIMIX**

Beam Angle (°)	c (mm)	Output (lm)	System (W)	ON/OFF	DALI
<b>4000 K</b>					
9°	380	583	7	32.WX.016.08.58	32.WX.017.08.08
		789	10	32.WX.016.08.59	32.WX.017.08.09
	680	1166	13	32.WX.016.08.60	32.WX.017.08.10
		1578	20	32.WX.016.08.61	32.WX.017.08.11
	980	1748	20	32.WX.016.08.62	32.WX.017.08.12
		2367	30	32.WX.016.08.63	32.WX.017.08.13
32°	1280	2332	27	32.WX.016.08.64	32.WX.017.08.14
		3156	40	32.WX.016.08.65	32.WX.017.08.15
	380	534	7	32.WX.016.08.66	32.WX.017.08.16
		724	10	32.WX.016.08.67	32.WX.017.08.17
	680	1068	13	32.WX.016.08.68	32.WX.017.08.18
		1447	20	32.WX.016.08.69	32.WX.017.08.19
Elliptical 14°x34°	980	1601	20	32.WX.016.08.70	32.WX.017.08.20
		2171	30	32.WX.016.08.71	32.WX.017.08.21
	1280	2135	27	32.WX.016.08.72	32.WX.017.08.22
		2894	40	32.WX.016.08.73	32.WX.017.08.23
	380	719	7	32.WX.016.08.74	32.WX.017.08.24
		1025	10	32.WX.016.08.75	32.WX.017.08.25
380	680	1438	13	32.WX.016.08.76	32.WX.017.08.26
		2049	20	32.WX.016.08.77	32.WX.017.08.27
	980	2157	20	32.WX.016.08.78	32.WX.017.08.28
		3074	30	32.WX.016.08.79	32.WX.017.08.29
1280	2875	27	32.WX.016.08.80	32.WX.017.08.30	
	4098	40	32.WX.016.08.81	32.WX.017.08.31	

**COMPONENTS**



**A END CAP (1pc)**

**COD**

End Cap 3 Poles ON/OFF	35.41.08.000084
End Cap 5 Poles DALI	35.41.08.000085



**B INITIAL CONECTOR (1pc)**

**COD**

Initial Conector Female 3 Poles ON/OFF	35.41.08.000086
Initial Conector Female 5 Poles DALI	35.41.08.000087

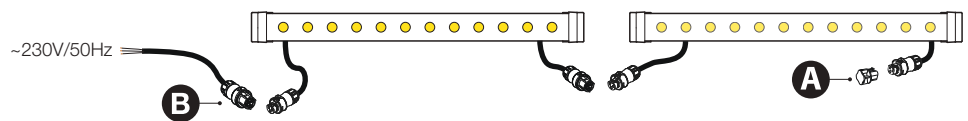

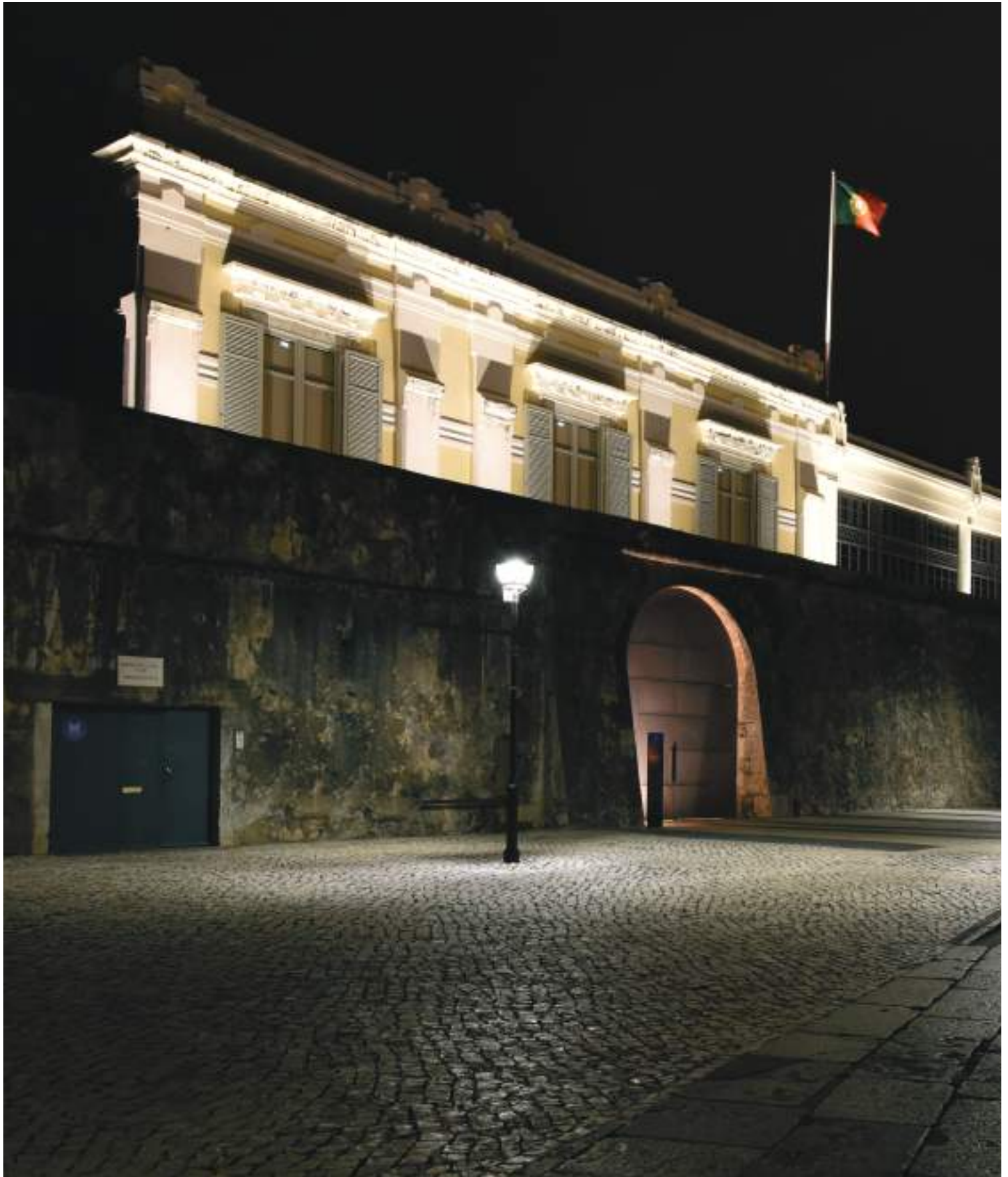

**KAIRO 100**  
BOLLARDS





# KAIRO 100

## BOLLARDS



### PT

- > Balizador de design simples e minimalista com emissão de luz em 360°.
- > Proporciona uma confortável orientação visual, ideal para marcação de zonas pedonais em áreas residenciais.
- > Formato tubular diâmetro 100 mm disponível em duas alturas distintas.
- > Pré-cablado com cabo H05RN-F de 1000 mm e ligador estanque para facilidade de instalação.
- > Luz branca confortável e sem encandeamto proporcionado pelo difusor Policarbonato Opal.
- > Corpo em aço inox AISI 316 ou em alumínio com tratamento primário anti-corrosão e revestimento a poliéster resistente aos UV.

### ES

- > Bolardo de diseño sencillo y minimalista con emisión luminosa en 360°.
- > Proporciona una cómoda orientación visual, ideal para el marcado de calzadas en áreas residenciales.
- > Formato tubular diámetro 100 mm disponible en dos alturas.
- > Precableado con cable H05RN-F de 1000 mm y conector sellado para facilidad de instalación.
- > Una cómoda luz blanca sin deslumbramiento gracias al difusor Policarbonato Opal.
- > Cuerpo en acero inoxidable AISI 316 o en aluminio con tratamiento primario anti-corrosión y recubrimiento de poliéster resistente a los UV.



**QUICK INFO**

**GENERAL**

Floor  
 IP65  
 IK08  
 850°C  
 Class II  
 Ta= -20°C +40°C

**OPTIC**

Opal Polycarbonate

**LED**

Efficacy up to 155 lm/W  
 3000 K, 4000 K  
 CRI >80  
 Lifetime 50 000 H  
 L80/B10@Tc=65°C

**ELETRICAL SYSTEM**

230V/50Hz  
 ON/OFF

**FINISHING**

Fine Brushed Stainless Steel  
 Metallic Textured Grey

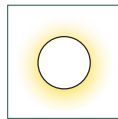

**KAIRO 100  
 OPAL DIFFUSER**

**FINE BRUSHED STAINLESS STEEL FINISHING**

c (mm)	Output (lm)	System (W)	COD
<b>3000 K</b>			
600	240	7	32.WX.015.08.34
1000	240	7	32.WX.015.08.35
<b>4000 K</b>			
600	270	7	32.WX.015.08.36
1000	270	7	32.WX.015.08.37

**METALLIC TEXTURED GREY FINISHING**

c (mm)	Output (lm)	System (W)	COD
<b>3000 K</b>			
600	240	7	32.WX.015.08.30
1000	240	7	32.WX.015.08.31
<b>4000 K</b>			
600	270	7	32.WX.015.08.32
1000	270	7	32.WX.015.08.33

**OPTIONS**

**LED**

2700 K, 5000 K, 6500 K

**FINISHING**

Other Colours

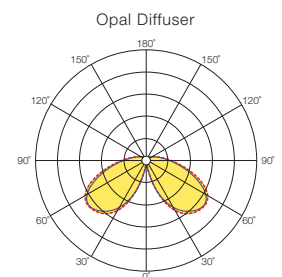
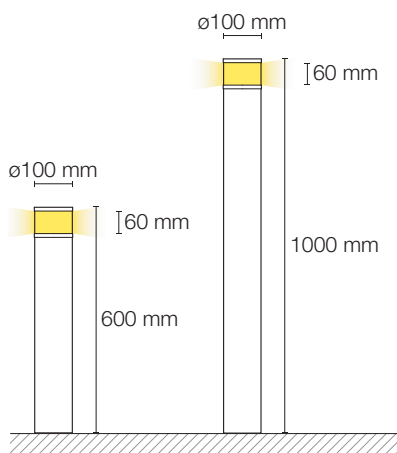

**SQUARE 100**  
BOLLARDS





> **SQUARE 100** BOLLARDS

# SQUARE 100

## BOLLARDS



### PT

- > Balizador de construção monobloco em versões com emissão por três ou quatro faces.
- > Corpo secção quadrada com 100 mm de lado em versões de 600 e 1000 mm de altura.
- > Pré-cabado com cabo H05RN-F de 1000 mm para rapidez e facilidade de instalação.
- > Sistema ótico constituído por difusores em Policarbonato Opal.
- > Corpo em alumínio com tratamento primário anti-corrosão e revestimento a poliéster resistente aos UV.

### ES

- > Bolardo de construcción monobloque con emisión por tres o cuatro lados.
- > Cuerpo de sección cuadrada con 100 mm de lado en versiones de 600 y 1000 mm de altura.
- > Precableado con cable H05RN-F de 1000 mm para una instalación rápida y fácil.
- > Sistema óptico constituido por difusores en Policarbonato Opal.
- > Cuerpo en aluminio con tratamiento primario anti-corrosión y recubrimiento de poliéster resistente a los UV.

**QUICK INFO**

**GENERAL**

Floor  
 IP65  
 IK06  
 850°C  
 Class II  
 Ta= -20°C +40°C

**OPTIC**

Opal Polycarbonate

**LED**

Efficacy up to 155 lm/W  
 3000 K, 4000 K  
 CRI >80  
 Lifetime 50 000 H  
 L80/B10@Tc=65°C

**ELETRICAL SYSTEM**

230V/50Hz  
 ON/OFF

**FINISHING**

Metallic Textured Grey

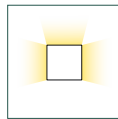

**SQUARE 100 - 3WD  
 OPAL DIFFUSER**

c (mm)	Output (lm)	System (W)	COD
<b>3000 K</b>			
600	176	7	32.WX.015.08.46
1000	176	7	32.WX.015.08.48
<b>4000 K</b>			
600	220	7	32.WX.015.08.50
1000	220	7	32.WX.015.08.52

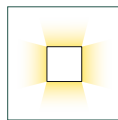

**SQUARE 100 - 4WD  
 OPAL DIFFUSER**

c (mm)	Output (lm)	System (W)	COD
<b>3000 K</b>			
600	235	7	32.WX.015.08.47
1000	235	7	32.WX.015.08.49
<b>4000 K</b>			
600	293	7	32.WX.015.08.51
1000	293	7	32.WX.015.08.53

**OPTIONS**

**LED**

2700 K, 5000 K, 6500 K

**FINISHING**

Other Colours

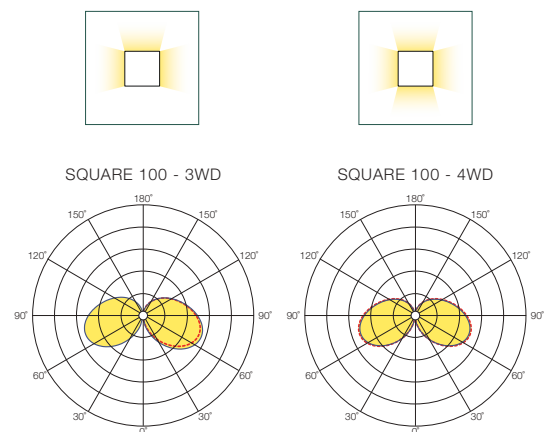
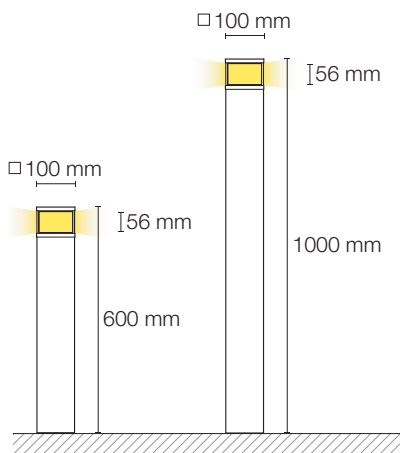

# NAIL BOLLARDS





# NAIL

## BOLLARDS



### PT

- > Luminária móvel com espigão para aplicação em jardins.
- > Em caminhos, relvados ou canteiros de flores, estas luminárias portáteis criam um efeito de luz muito agradável.
- > Pré-cablado com cabo H05RN-F de 5000 mm para instalação imediata.
- > Difusor Policarbonato Opal.
- > Corpo e espigão em aço com tratamento primário anti-corrosão e revestimento a poliéster resistente aos UV.

### ES

- > Luminaria portátil con pica de puesta a tierra para aplicación en jardines.
- > En senderos, céspedes y macizos de flores, estas luminarias portátiles crean un efecto de luz muy agradable.
- > Precableado con cable H05RN-F de 5000 mm para una instalación inmediata.
- > Difusor Policarbonato Opal.
- > Cuerpo y pica de puesta a tierra en acero con tratamiento primario anti-corrosión y recubrimiento de poliéster resistente a los UV.



**QUICK INFO**

**GENERAL**

Floor  
 IP67  
 IK10  
 850°C  
 Class II  
 Ta= -20°C +40°C

**OPTIC**

Opal Polycarbonate

**LED**

Efficacy up to 188 lm/W  
 3000 K, 4000 K  
 CRI >80  
 Lifetime 72 000 H  
 L80/B10@Tc=65°C

**ELETRICAL SYSTEM**

230V/50Hz  
 ON/OFF

**FINISHING**

Corten Steel Painting

**OPTIONS**

**LED**

2700 K, 5000 K, 6500 K

**FINISHING**

 Other Colours

**NAIL**

**OPAL DIFFUSER**

**CORTEN STEEL FINISHING**

Output (lm)	System (W)	COD
<b>3000 K</b>		
1145	9	32.WX.015.08.38
1780	15	32.WX.015.08.39
<b>4000 K</b>		
1198	9	32.WX.015.08.40
1862	15	32.WX.015.08.41

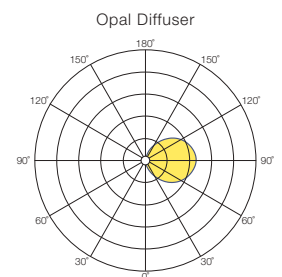
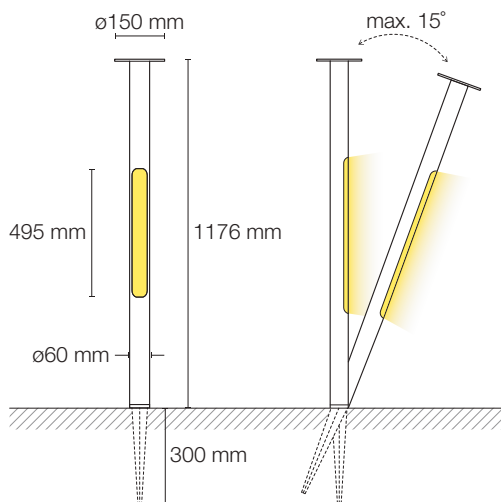

# TYOS

## BOLLARDS



### PT

- > Balizador de design simples e minimalista com distribuição de luz assimétrica.
- > Proporciona uma confortável orientação visual, ideal para marcação de zonas pedonais em áreas residenciais.
- > Pré-cablado com cabo H05RN-F de 1000 mm para rapidez e facilidade de instalação.
- > Refletor em alumínio e difusor de proteção em Policarbonato.
- > Corpo em alumínio com tratamento primário anti-corrosão e revestimento a poliéster resistente aos UV.

### ES

- > Bolardo de diseño sencillo y minimalista con distribución de luz asimétrica.
- > Proporciona una cómoda orientación visual, ideal para el marcado de calzadas en áreas residenciales.
- > Precableado con cable H05RN-F de 1000 mm para una instalación rápida y fácil.
- > Reflector en aluminio y difusor de protección en Policarbonato.
- > Cuerpo en aluminio con tratamiento primario anti-corrosión y recubrimiento de poliéster resistente a los UV.

**QUICK INFO**

**GENERAL**

Floor  
 IP55  
 IK06  
 850°C  
 Class II  
 Ta= -20°C +40°C

**OPTIC**

Clear Polycarbonate

**LAMP - NOT INCLUDED**

GX53

**ELETRICAL SYSTEM**

230V/50Hz

**FINISHING**

Metallic Textured Grey

**OPTIONS**

**FINISHING**

 Other Colours

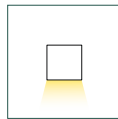

**TYOS - LAMP**

**CLEAR DIFFUSER**

c (mm)	LAMP Power (W)	COD
<b>GX53</b>		
350	max. 9	32.WX.015.08.44
600	max. 9	32.WX.015.08.45

> Lamp not included.

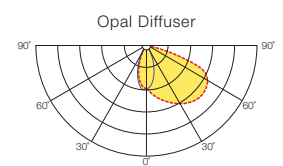
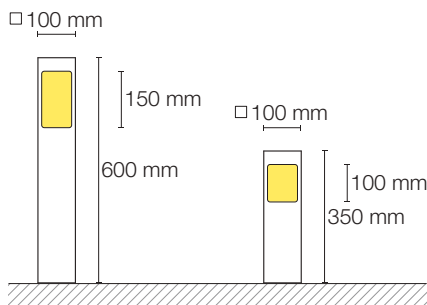

Lamp: 9W (GX53).

**KAIRO**  
COLUMNS





> **KAIRO 150** COLUMNS

# KAIRO

## COLUMNS



### PT

- > Coluna cilíndrica de construção monobloco com emissão de luz em 360°.
- > Formato tubular em versões com 120 e 150 mm de diâmetro.
- > Pré-cablado com cabo H05RN-F de 1000 mm para rapidez e facilidade de instalação.
- > Sistema ótico constituído por difusor de proteção em PMMA cristal resistente aos UV e difusor interno em Policarbonato Opal.
- > Corpo em alumínio com tratamento primário anti-corrosão e revestimento a poliéster resistente aos UV.

### ES

- > Columna cilíndrica de construcción monobloque con emisión luminosa en 360°.
- > Formato tubular en versiones con 120 o 150 mm de diámetro.
- > Precableado con cable H05RN-F de 1000 mm para una instalación rápida y fácil.
- > Sistema óptico compuesto por difusor de protección en PMMA resistente a los UV y difusor interior en Policarbonato Opal.
- > Cuerpo en aluminio con tratamiento primario anti-corrosión y recubrimiento de poliéster resistente a los UV.

**QUICK INFO**

**GENERAL**

Floor  
 IP65  
 IK08  
 850°C  
 Class II  
 Ta= -20°C +40°C

**OPTIC**

Opal Polycarbonate  
 Clear PMMA

**LED**

Efficacy up to 160 lm/W  
 3000 K, 4000 K  
 CRI >80  
 Lifetime 50 000 H  
 L80/B10 @Tc=65°C

**ELETRICAL SYSTEM**

230V/50Hz  
 ON/OFF

**FINISHING**

Metallic Textured Grey

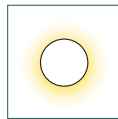

**KAIRO 120**

c (mm)	Output (lm)	System (W)	COD
<b>3000 K</b>			
2000	1679	29	32.WX.015.08.54
2500	1679	29	32.WX.015.08.55
<b>4000 K</b>			
2000	2099	29	32.WX.015.08.56
2500	2099	29	32.WX.015.08.57

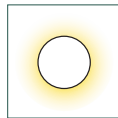

**KAIRO 150**

c (mm)	Output (lm)	System (W)	COD
<b>3000 K</b>			
3000	2148	42	32.WX.015.08.62
3500	2148	42	32.WX.015.08.63
4000	2148	42	32.WX.015.08.64
<b>4000 K</b>			
3000	2685	42	32.WX.015.08.65
3500	2685	42	32.WX.015.08.66
4000	2685	42	32.WX.015.08.67

**OPTIONS**

**LED**

2700 K, 5000 K, 6500 K

**FINISHING**

Other Colours

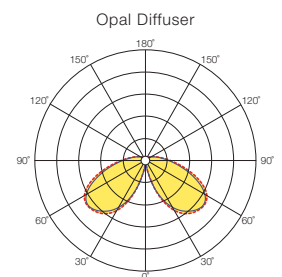
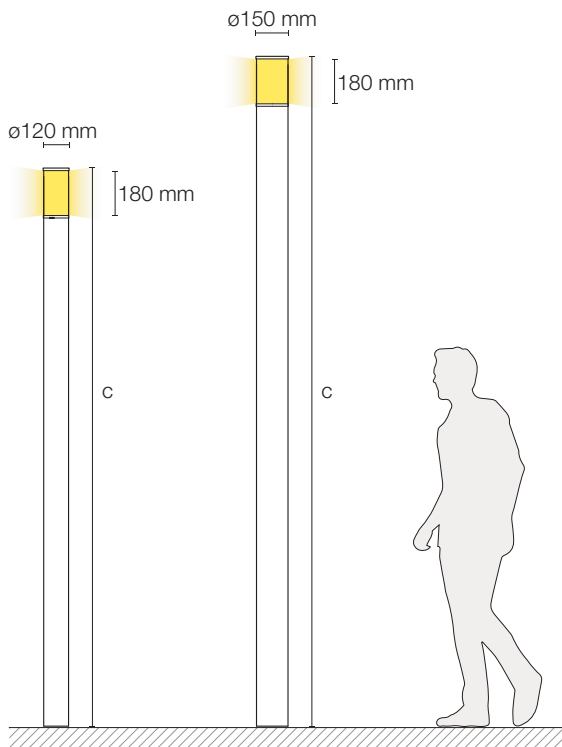

# SQUARE COLUMNS



## PT

- > Coluna de construção monobloco com emissão simétrica do fluxo luminoso.
- > Corpo secção quadrada em versões com 120 ou 150 mm de lado.
- > Pré-cabado com cabo H05RN-F de 1000 mm para rapidez e facilidade de instalação.
- > Sistema ótico constituído por quatro difusores em Policarbonato Opal.
- > Corpo em alumínio com tratamento primário anti-corrosão e revestimento a poliéster resistente aos UV.

## ES

- > Columna de construcción monobloque con emisión simétrica del flujo luminoso.
- > Cuerpo de sección cuadrada en versiones con 120 o 150 mm de lado.
- > Precableado con cable H05RN-F de 1000 mm para una instalación rápida y fácil.
- > Sistema óptico compuesto por cuatro difusores en Policarbonato Opal.
- > Cuerpo en aluminio con tratamiento primario anti-corrosión y recubrimiento de poliéster resistente a los UV.



**QUICK INFO**

**GENERAL**

Floor  
 IP65  
 IK08  
 850°C  
 Class II  
 Ta= -20°C +40°C

**OPTIC**

Opal Polycarbonate

**LED**

Efficacy up to 160 lm/W  
 3000 K, 4000 K  
 CRI >80  
 Lifetime 50 000 H  
 L80/B10 @Tc=65°C

**ELETRICAL SYSTEM**

230V/50Hz  
 ON/OFF

**FINISHING**

Metallic Textured Grey

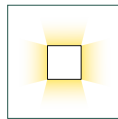

**SQUARE 120**

c (mm)	Output (lm)	System (W)	COD
<b>3000 K</b>			
2000	1595	29	32.WX.015.08.58
2500	1595	29	32.WX.015.08.59
<b>4000 K</b>			
2000	1994	29	32.WX.015.08.60
2500	1994	29	32.WX.015.08.61

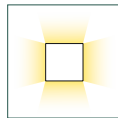

**SQUARE 150**

c (mm)	Output (lm)	System (W)	COD
<b>3000 K</b>			
3000	2040	42	32.WX.015.08.68
3500	2040	42	32.WX.015.08.69
4000	2040	42	32.WX.015.08.70
<b>4000 K</b>			
3000	2550	42	32.WX.015.08.71
3500	2550	42	32.WX.015.08.72
4000	2550	42	32.WX.015.08.73

**OPTIONS**

**LED**

2700 K, 5000 K, 6500 K

**FINISHING**

Other Colours

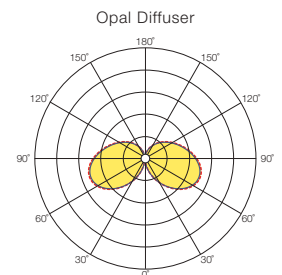
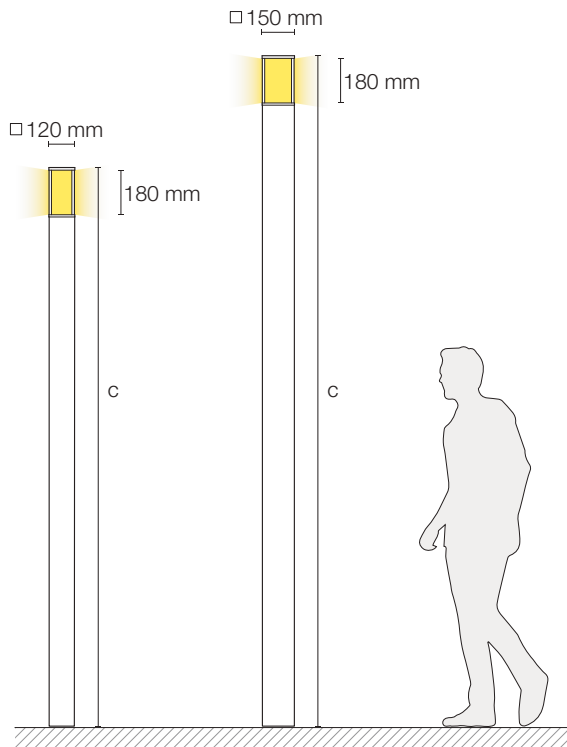

**SQUARE-D1**  
COLUMNS





> SQUARE-D1 COLUMNS

# SQUARE-D 150

## COLUMNS



### PT

- > Coluna decorativa para iluminação exterior.
- > Corpo secção quadrada com 150 mm de lado disponível em várias alturas.
- > Esta coluna pode ser fornecida com padrões personalizados nas laterais – opção disponível sob consulta.
- > Pré-cablado com cabo H05RN-F de 1000 mm para rapidez e facilidade de instalação.
- > Corpo em perfil de alumínio anodizado mate.

### ES

- > Columna decorativa para iluminación exterior.
- > Cuerpo de sección cuadrada con 150 mm de lado disponible en varias alturas.
- > Estas columnas pueden ser suministradas con diseños personalizados en los laterales – opción disponible bajo consulta.
- > Precableado con cable H05RN-F de 1000 mm para una instalación rápida y fácil.
- > Cuerpo en perfil de aluminio anodizado mate.

**QUICK INFO**

**GENERAL**

Floor  
 IP65  
 IK08  
 850°C  
 Class II  
 Ta= -20°C +40°C

**OPTIC**

Clear Tempered Glass

**LED**

Efficacy up to 160 lm/W  
 3000 K, 4000 K  
 CRI >80  
 Lifetime 50 000 H  
 L80/B10@Tc=65°C

**ELETRICAL SYSTEM**

230V/50Hz  
 ON/OFF

**FINISHING**

Matt Anodized Aluminium

**OPTIONS**

**LED**

2700 K, 5000 K, 6500 K

**FINISHING**

 Other Colours

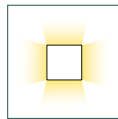

**SQUARE-D1 150**

c (mm)	Output (lm)	System (W)	COD
<b>3000 K</b>			
3500	1480	29	32.WX.018.08.28
<b>4000 K</b>			
3500	1850	29	32.WX.018.08.29

**SQUARE-D2 150**

c (mm)	Output (lm)	System (W)	COD
<b>3000 K</b>			
3500	1410	29	32.WX.018.08.30
<b>4000 K</b>			
3500	1760	29	32.WX.018.08.31

**SQUARE-D3 150**

c (mm)	Output (lm)	System (W)	COD
<b>3000 K</b>			
3000	1650	29	32.WX.018.08.24
3500	1650	29	32.WX.018.08.25
<b>4000 K</b>			
3000	2060	29	32.WX.018.08.26
3500	2060	29	32.WX.018.08.27

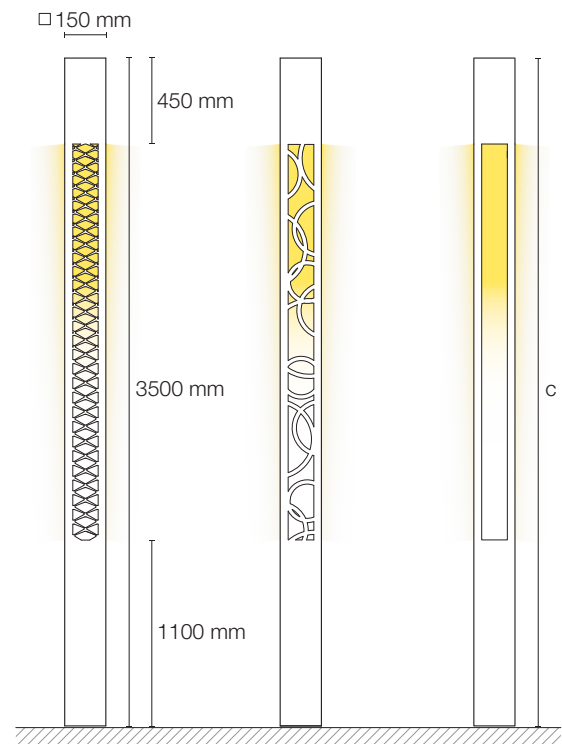
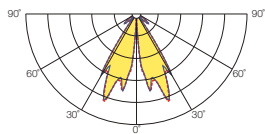

# SQUARE-D 220

## COLUMNS



### PT

- > Coluna decorativa para iluminação exterior.
- > Corpo secção quadrada com 220 mm de lado disponível em várias alturas.
- > Esta coluna pode ser fornecida com padrões personalizados nas laterais – opção disponível sob consulta.
- > Pré-cablado com cabo H05RN-F de 1000 mm para rapidez e facilidade de instalação.
- > Corpo em alumínio com tratamento primário anti-corrosão e revestimento a poliéster resistente aos UV.

### ES

- > Columna decorativa para iluminación exterior.
- > Cuerpo de sección cuadrada con 220 mm de lado disponible en varias alturas.
- > Estas columnas pueden ser suministradas con diseños personalizados en los laterales – opción disponible bajo consulta.
- > Precableado con cable H05RN-F de 1000 mm para una instalación rápida y fácil.
- > Cuerpo en aluminio con tratamiento primario anti-corrosión y recubrimiento de poliéster resistente a los UV.

**QUICK INFO**

**GENERAL**

Floor  
 IP65  
 IK08  
 850°C  
 Class II  
 Ta= -20°C +40°C

**OPTIC**

Clear Tempered Glass

**LED**

Efficacy up to 160 lm/W  
 3000 K, 4000 K  
 CRI >80  
 Lifetime 50 000 H  
 L80/B10@Tc=65°C

**ELETRICAL SYSTEM**

230V/50Hz  
 ON/OFF

**FINISHING**

Graphite Black  
 Corten Steel

**OPTIONS**

**LED**

2700 K, 5000 K, 6500 K

**FINISHING**

 Other Colours

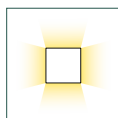

**SQUARE-D1 220**

c (mm)	Output (lm)	System (W)	GRAPHITE BLACK	CORTEN STEEL
<b>3000 K</b>				
3500	1480	29	32.WX.015.08.78	32.WX.018.08.20
<b>4000 K</b>				
3500	1850	29	32.WX.015.08.79	32.WX.018.08.21

**SQUARE-D2 220**

c (mm)	Output (lm)	System (W)	GRAPHITE BLACK	CORTEN STEEL
<b>3000 K</b>				
3500	1410	29	32.WX.018.08.14	32.WX.018.08.22
<b>4000 K</b>				
3500	1760	29	32.WX.018.08.15	32.WX.018.08.23

**SQUARE-D3 220**

c (mm)	Output (lm)	System (W)	GRAPHITE BLACK	CORTEN STEEL
<b>3000 K</b>				
3000	1650	29	32.WX.015.08.74	32.WX.018.08.16
3500	1650	29	32.WX.015.08.75	32.WX.018.08.17
<b>4000 K</b>				
3000	2060	29	32.WX.015.08.76	32.WX.018.08.18
3500	2060	29	32.WX.015.08.77	32.WX.018.08.19

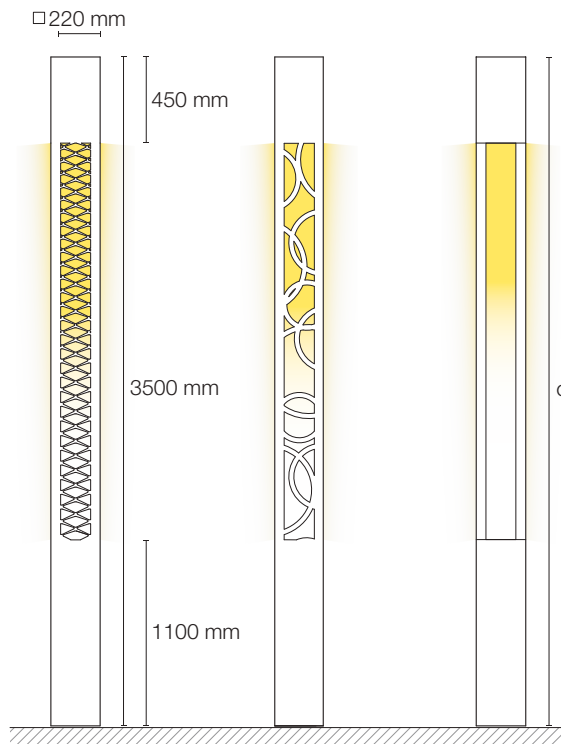
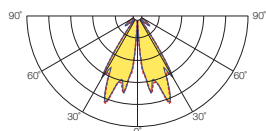



> SQUARE-D3 220 COLUMNS





> TUPOLI IP65 COLUMNS

# TUPOLI IP65

## COLUMNS



### PT

- > Coluna decorativa com emissão de luz em 360°.
- > Ideal para fornecer uma boa orientação visual e sensação de segurança em zonas pedonais de espaços urbanos.
- > Índice de proteção IP65 com resistência a impactos IK07.
- > Pré-cablado com cabo H05RN-F de 1000 mm para rapidez e facilidade de instalação.
- > Difusor em Policarbonato Opal.
- > Corpo e base de fixação em alumínio com tratamento primário anti-corrosão e revestimento a poliéster resistente aos UV.

### ES

- > Columna decorativa con emisión luminosa en 360°.
- > Ideal para proporcionar una buena orientación visual y una sensación de seguridad en entornos urbanos peatonales.
- > Grado de protección IP65 con resistencia a los impactos IK07.
- > Precableado con cable H05RN-F de 1000 mm para una instalación rápida y fácil.
- > Difusor en Policarbonato Opal.
- > Cuerpo y base de fijación en aluminio con tratamiento primario anti-corrosión y recubrimiento de poliéster resistente a los UV.

**QUICK INFO**

**GENERAL**

Floor  
 IP65  
 IK07  
 850°C  
 Class I  
 Ta= -20°C +40°C

**OPTIC**

Opal Polycarbonate

**LED**

Efficacy up to 141 lm/W  
 3000 K, 4000 K  
 CRI >80  
 Lifetime 50 000 H  
 L80/B10 @Tc=55°C

**ELETRICAL SYSTEM**

230V/50Hz  
 ON/OFF

**FINISHING**

Metallic Textured Grey

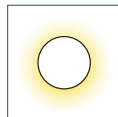

**TUPOLI IP65  
 OPAL DIFFUSER**

c (mm)	Output (lm)	System (W)	COD
<b>3000 K</b>			
1760	1648	16	32.WX.018.08.10
2060	2472	23	32.WX.018.08.11
<b>4000 K</b>			
1760	1648	15	32.WX.018.08.12
2060	2472	22	32.WX.018.08.13

**OPTIONS**

**LED**

2700 K, 5000 K, 6500 K

**ELECTRICAL SYSTEM**

DALI, DIM 1-10V

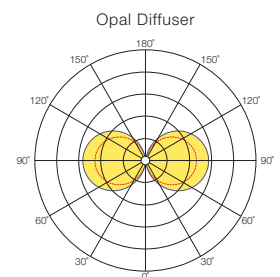
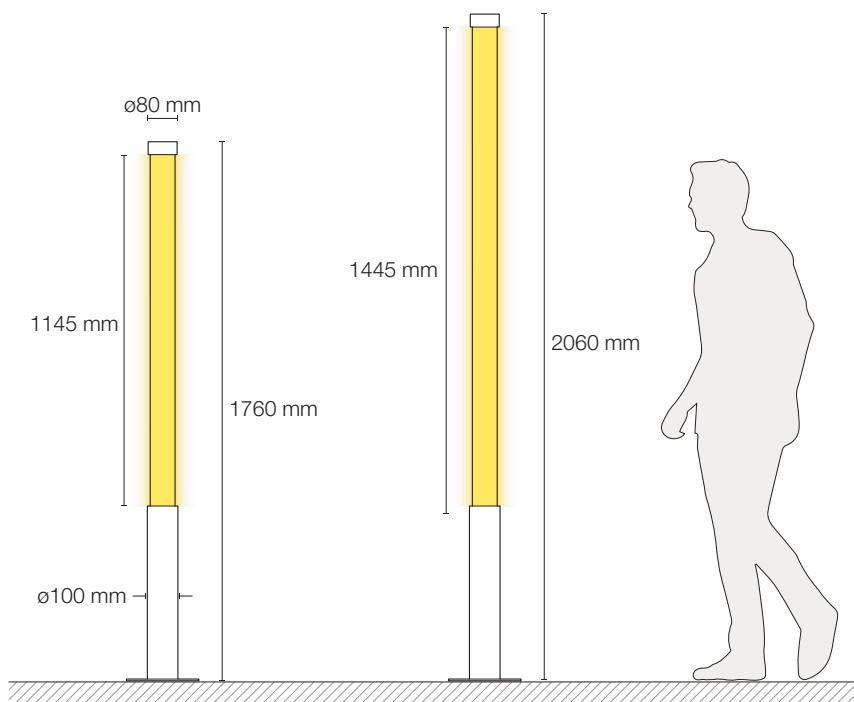





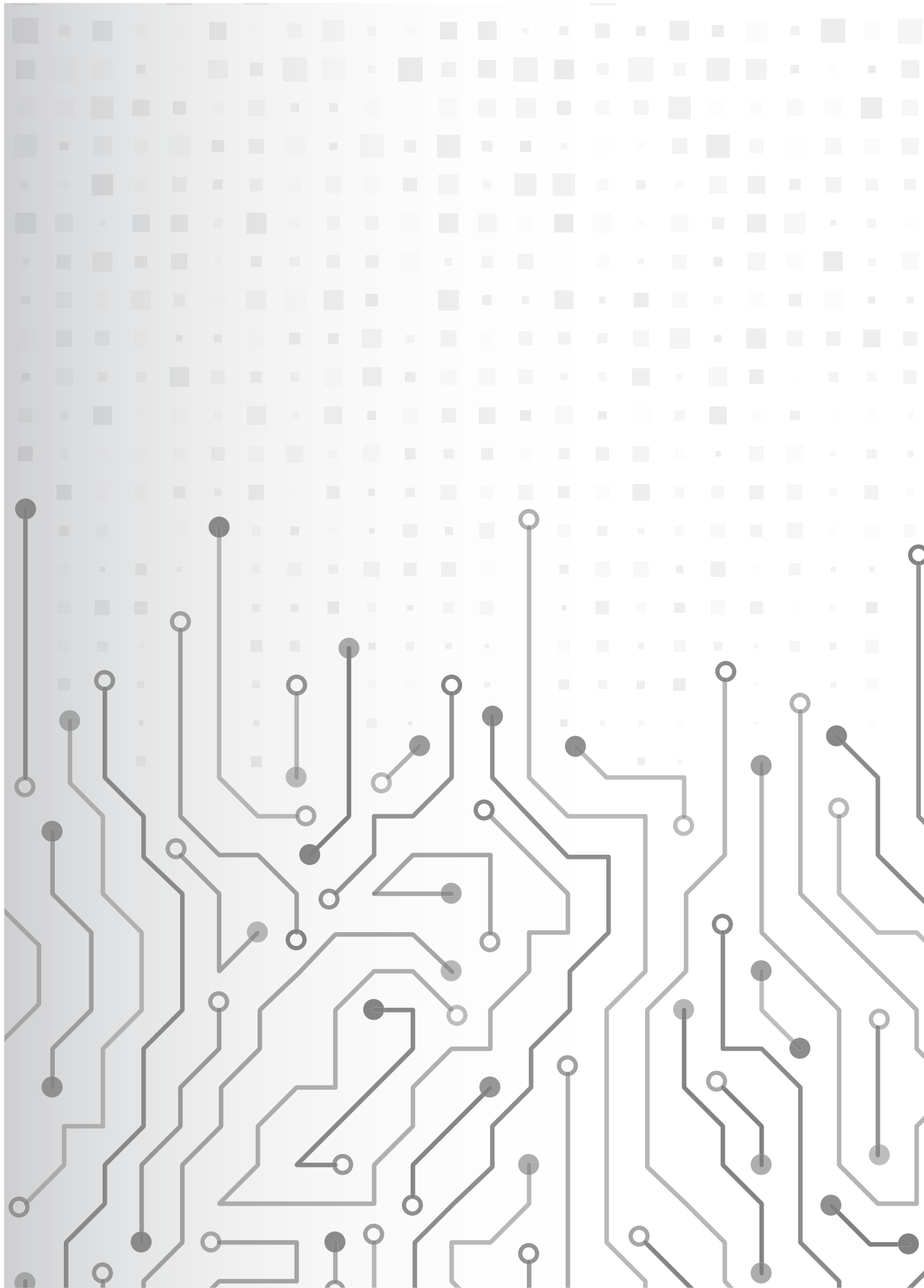

# ADDITIONAL INFORMATION

**TECHNICAL INFO**

pag. 734

**LED TECHNOLOGY**

pag. 736

**SYSTEMS**

pag. 737

**SENSORS**

pag. 738

**FINISHING**



pag. 740

**A-Z INDEX**

pag. 742

# TECHNICAL INFORMATION

## SÍMBOLOGIA E ABREVIATURAS

<b>EN 60 598</b>	> Todos os produtos são projetados e produzidos de acordo com as normas europeias da série EN 60 598.
<b>ROHS 2</b>	> Diretiva 2011/65/UE do Parlamento Europeu e do Conselho, de 8 de Junho de 2011, relativa à restrição do uso de determinadas substâncias perigosas em equipamentos elétricos e eletrônicos.
<b>CE</b>	> Todos os produtos cumprem os requisitos das diretivas europeias aplicáveis, possuindo marcação CE.
<b>IPXX</b>	> O prefixo IP seguido de dois algarismos é um sistema de codificação que indica a “resistência” da luminária à penetração de poeiras, corpos sólidos e líquidos de acordo com a norma EN 60598. O primeiro algarismo identifica a proteção contra a penetração de corpos sólidos e poeira, e o segundo à entrada de água e humidade.
<b>IKXX</b>	> Grau de resistência dos invólucros das luminárias a impactos mecânicos externos, definidos pela norma EN 62262.
<b>650° C 750° C 850° C 960° C</b>	> Resistência ao ensaio do fio incandescente de acordo com a norma EN 60598-1.
	> Classe I identifica luminárias com isolamento principal e proteção por ligação à terra prevista nas partes metálicas acessíveis.
	> Classe II identifica luminárias com isolamento principal e isolamento suplementar, mas sem meio de proteção por ligação à terra.
	> Classe III identifica luminárias previstas para alimentação em muita baixa tensão de segurança.
<b>Ta= ...°C</b>	> O símbolo Ta = ...°C indica o intervalo de temperatura ambiente, medido em graus Celsius (°C), na qual a luminária está preparada para funcionar.
<b>UGR &lt;XX</b>	> O Unified Glare Rating é usado para avaliar e limitar o encandeamento direto das luminárias. Este método calcula o encandeamento da instalação de iluminação a partir de uma posição definida do observador. Os valores limite de UGR estão definidos na norma EN 12464 - Iluminação dos locais de trabalho.
<b>Beam Angle (°)</b>	> Refere-se ao ângulo de abertura do feixe de luz da luminária.
<b>Output (lm)</b>	> Os lumens (lm) indicados referem-se ao fluxo luminoso total emitido pela luminária. Este valor está sujeito a uma tolerância de +/- 10%.
<b>System (W)</b>	> A potência do sistema indicada em Watts (W), refere-se ao consumo total da luminária após a sua estabilização térmica, incluindo todos os componentes instalados, módulo de LED e Driver. Os valores indicados são nominais, estando sujeitos a uma tolerância de +/- 10%.
<b>LED Power (W)</b>	> A potência indicada em Watts (W) refere-se ao consumo do módulo LED, excluindo Driver (Driver externo fornecido separadamente). Este valor está sujeito a uma tolerância de +/- 10%.
<b>LAMP Power (W)</b>	> A potência indicada em Watts (W) refere-se à potência máxima admissível da lâmpada a usar na luminária (luminárias fornecidas sem lâmpada).



## CARACTERÍSTICAS DO LED

- XX00 K** > O termo Temperatura de Cor em Kelvin (K) é usado para definir a cor da luz branca.
- Tunable White** > A opção Tunable White disponível no catálogo, permite o ajuste da temperatura de cor de branco quente a branco frio entre 2700 K e 6500 K, permitindo conceitos de iluminação de Human Centric Lighting.
- RGB** > As luminárias com LED RGB permitem o ajuste infinito da cor da luz, através da combinação de três cores primárias, o vermelho, o verde e o azul.
- RGBW** > As luminárias LED RGBW utilizam um chip branco dedicado além do vermelho, verde e azul, que permite não só uma vasta gama de cores personalizáveis, mas também um tom de branco puro.
- CRI >XX** > O Índice de Restituição de Cor (CRI) representa a capacidade da fonte de luz em conseguir reproduzir fielmente as cores dos objetos iluminados, por comparação com uma fonte de luz natural. Um CRI acima de 80 é bom, acima de 90 é muito bom.
- lm/W** > A eficiência luminosa da luminária é o rácio entre o fluxo luminoso emitido e a potência consumida pela luminária. Este valor é expresso em lumen por watt (lm/W).
- Lifetime** > O tempo de vida útil do módulo LED é expresso em horas e depende da temperatura máxima permitida no tc-point (@Tc).
- LXX/BXX** > O valor L representa a percentagem do fluxo luminoso inicial que o LED continua a emitir após o número especificado de horas de funcionamento. O valor B indica a percentagem de LEDs que poderão estar abaixo do valor L específico.

**Specific Colours** > Os espectros especiais de luz valorizam a percepção da qualidade, são suaves para os produtos expostos e realçam a sua frescura e naturalidade. A nossa gama de luminárias com módulos LED, concebidos especificamente para a iluminação de produtos alimentares e de moda, mantêm as cores com um aspeto rico, apelativo e vibrante, enquanto tornam os brancos incrivelmente brancos com uma aparência natural e fresca.

> **BREAD**

Os tons de castanho dão uma aparência mais crocante ao pão e à pastelaria.

> **VEGETABLES**

Acentua a frescura de legumes e frutas.

> **FISH**

As cores frias sublinham a frescura do peixe e marisco.

> **MEAT**

Os tons vermelhos das carnes e enchidos tornam-se visivelmente mais fortes.

> **FASHION**

Gera cores brilhantes para exibir o vestuário sob uma luz perfeita, mostrando as cores verdadeiras.

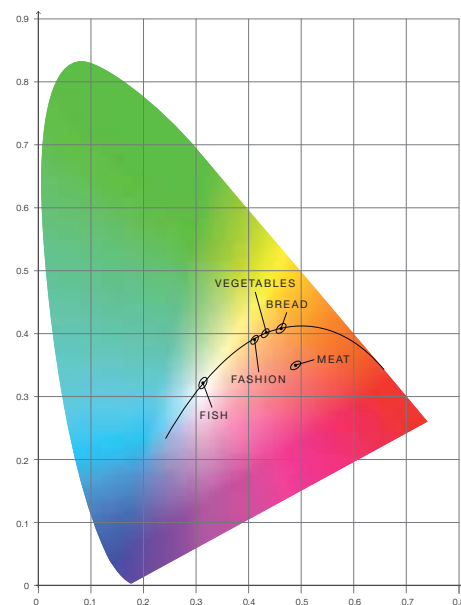

# LED TECHNOLOGY FEATURES

## BINNING

Na produção dos chips de LED, tal como noutros processos de fabrico de semicondutores, LEDs de diferentes lotes de fabrico possuem propriedades diferentes em relação ao fluxo emitido e à temperatura de cor. Apesar das diferenças serem pequenas, influenciam a qualidade final do LED. Assim, os fabricantes classificam os LEDs em subgrupos (“bin”) de acordo com as suas características, de modo a que todos os LEDs de um determinado “bin” tenham aparência e fluxos semelhantes. A utilização de LEDs de um único “bin” assegura a uniformidade quanto ao fluxo e à cor de uma determinada aplicação.

## CONSISTÊNCIA DE COR

A sigla SDCM (Desvio Padrão de Correspondência de Cor) também conhecida como “Elipse de MacAdam” é usada para indicar a dispersão de cor da fonte luminosa, ou seja, quão distantes os módulos LED diferem em relação à percepção de cores. Este sistema baseia-se na capacidade do olho humano em discernir as diferenças de cor (variação de cromaticidade) e classifica o módulo LED numa escala de 0 a 10 steps SDCM.

Dentro de 1 elipse de MacAdam a diferença de cor não é perceptível ao olho humano sob qualquer condição. De 1 a 3 elipses é muito difícil discernir qualquer diferença, o que significa que até 3 elipses MacAdam todos os LEDs são muito homogêneos em relação à temperatura de cor.

### VISIBILIDADE DOS STEPS MACADAMS



> 3 SDCM



> 4 SDCM

## SEGURANÇA FOTOBIOLOGICA

A norma EN 62471 de Segurança Fotobiológica define níveis de radiação ultravioleta, infravermelha e azul emitida pelo LED e o respetivo nível de risco tolerado pelo utilizador. Em termos de segurança fotobiológica, as fontes de luz LED têm características semelhantes às tecnologias tradicionais, como lâmpadas incandescentes/fluorescentes. De modo geral as luminárias disponíveis no mercado (LED ou tradicionais) são seguras, quando instaladas e usadas de acordo com as normas e regulamentos aplicáveis.

### STEPS ELIPSES MACADAM

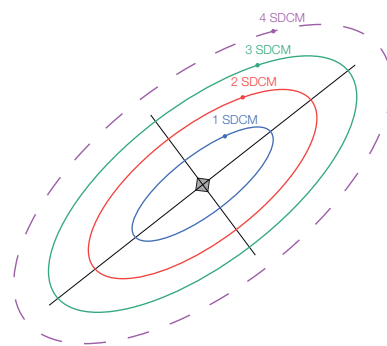

- > 1 SDCM - Quase impossível ver diferenças.
- > 2 SDCM - As diferenças podem ser detetadas através de instrumentos de medição.
- > 3 SDCM - Muito poucas diferenças visíveis.
- > 4 SDCM - As diferenças de cor são claramente visíveis.

### GRUPOS DE RISCO (RG)

- > RG 0 - Isento de Risco, mesmo com visualização ilimitada da fonte de luz.
- > RG 1 - Isento de Risco numa utilização normal.
- > RG 2 - Isento de Risco devido à resposta de aversão natural a fontes de luz muito brilhantes ou devido ao desconforto térmico.
- > RG 3 - Risco mesmo com exposição momentânea. Medidas de proteção são sempre necessárias.

# SYSTEMS

## ELECTRICAL AND CONTROLS

### SISTEMAS ELÉTRICOS

**ON/OFF** > Fonte de alimentação ON/OFF (sem regulação do fluxo).



> DALI (Digital Addressable Lighting Interface) é um protocolo universal para gestão de sistemas de iluminação.

**DIM 1-10V** > Regulação do fluxo luminoso (dimming) através de controlo analógico 1-10V.

**DSI** > Digital Serial Interface (DSI) é um protocolo digital de controlo da iluminação.

**Phase-cut** > Regulação do fluxo luminoso (dimming) através de dimmer de corte de fase.

**DMX** > Digital Multiplex (DMX) é um protocolo digital para controlo de sistemas de iluminação inteligente, que permite criar cenas dinâmicas personalizadas, regulação do fluxo ou controlo da temperatura de cor.

### SISTEMAS DE CONTROLO



> Luminárias com Bluetooth controladas diretamente a partir de um smartphone ou tablet, sem necessidade de qualquer componente adicional. Permite a comutação individual das luminárias, regulação do fluxo luminoso e integração em cenas de luz.

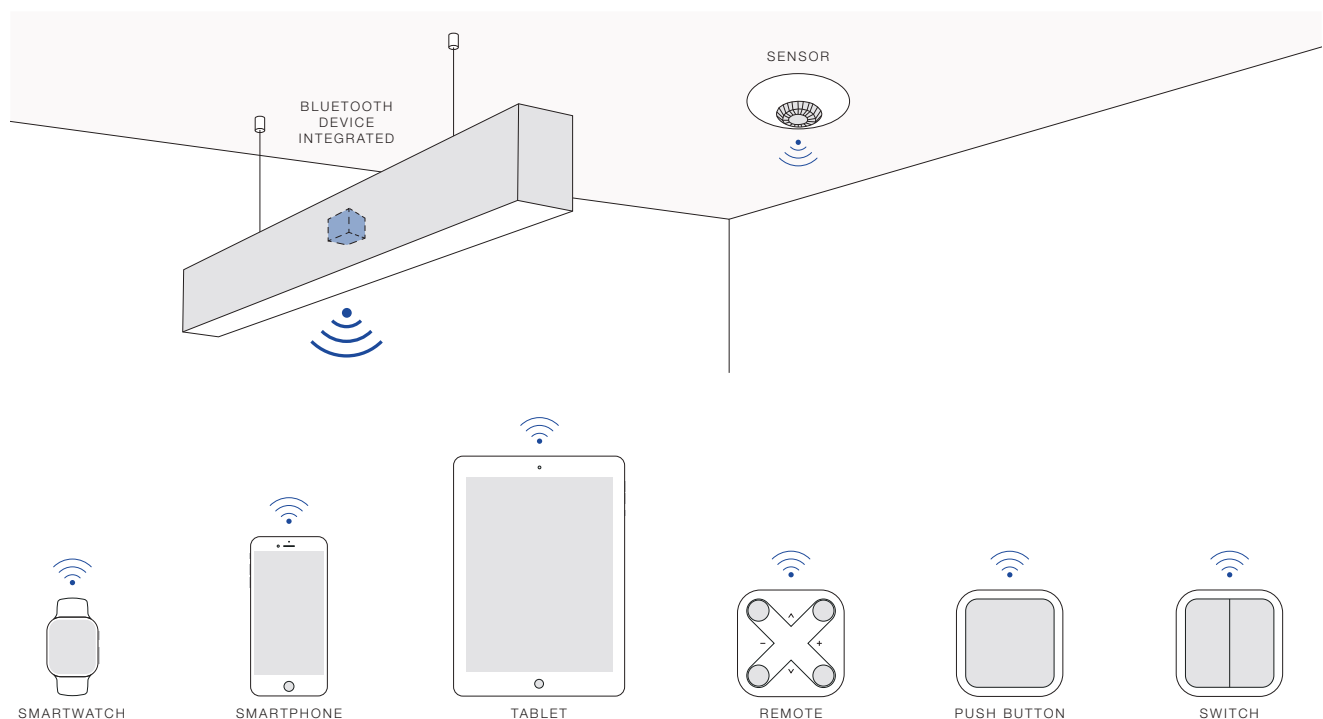

# SENSORS

## MOTION & AMBIENT LIGHT

O controlo automatizado baseado em sensores, torna a iluminação simples para os utilizadores de salas e espaços. A tecnologia de controlo com sensores, quando combinada com o sistema de luminárias adequado, faz um uso inteligente dos recursos de iluminação, potenciando economias de energia significativas.

O uso mais frequente de sensores no controlo da iluminação é baseado na ocupação da sala e nos níveis de luz ambiente, assegurando o nível de luz adequado, fornecido no momento certo de acordo com as necessidades do utilizador.

A seguir uma breve descrição de três tipos de sensores de controle de iluminação.

### SENSORES DE MOVIMENTO (MOTION)

Quando se pretende que a iluminação ligue automaticamente com a entrada de pessoas num espaço e desligue quando não estiver a ser utilizado. Estes sensores reagem ao movimento de pessoas e veículos dentro da sua faixa de deteção e respondem com uma comutação ON/OFF.

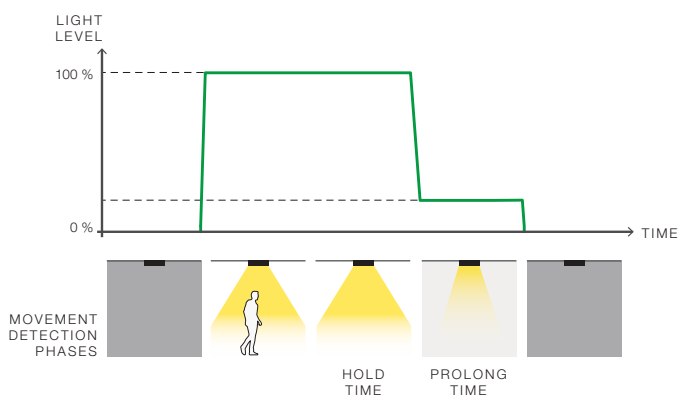

### PRINCIPAIS BENEFÍCIOS

**> Bem-estar e Conveniência**

A iluminação liga automaticamente.

**> Segurança**

Garante níveis seguros de iluminação em corredores e escadarias sempre que há movimento.

**> Higiene e Segurança**

Os funcionários não necessitam de tocar em interruptores. Importante para pessoal médico, operários fabris, pessoal de cozinha, etc.

**> Economia de Energia**

Iluminação ligada somente enquanto há presença de pessoas na sala.

### ILUMINAÇÃO AMBIENTE (AMBIENT LIGHT)

Para garantir o conforto, bem-estar e produtividade, reduzindo ao mesmo tempo os custos energéticos, os edifícios modernos devem maximizar o uso de luz natural. Os sensores de luz são usados em salas e espaços onde a luz natural pode fornecer parte ou a totalidade da luz necessária e onde a iluminação artificial pode ser ajustada em função dos diferentes níveis de luz ambiente.

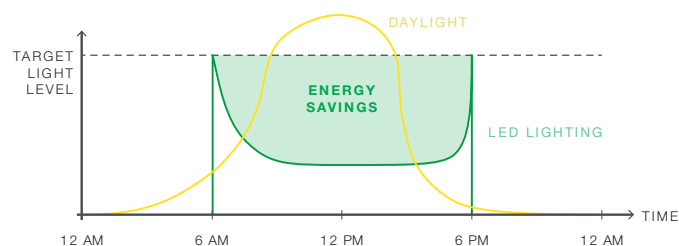

### PRINCIPAIS BENEFÍCIOS

**> Bem-estar e Conveniência**

A intensidade luminosa pretendida é mantida automaticamente.

**> Facilidade de Uso**

Controlo automático da iluminação para manter permanentemente o nível de luz adequado.

**> Economia de Energia**

Diminuição da iluminação artificial em função do aumento dos níveis de luz natural no espaço.

## MOVIMENTO E LUZ AMBIENTE (MOTION & AMBIENT LIGHT)

Estes multi-sensores permitem a deteção de movimento combinada com a iluminação ambiente para um controlo totalmente configurável da iluminação artificial de acordo com as necessidades do cliente.

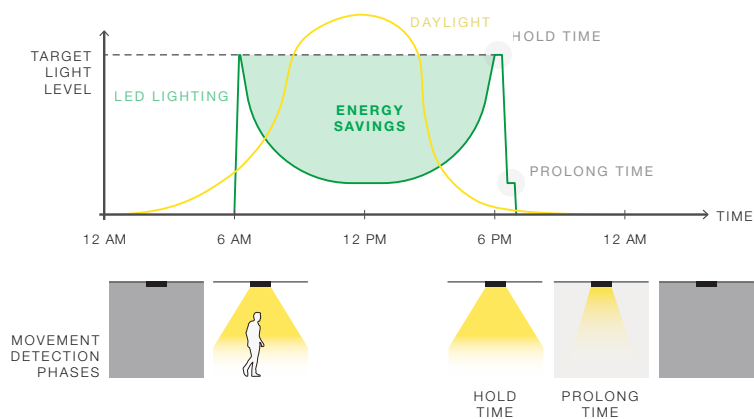

## PRINCIPAIS BENEFÍCIOS

### > Bem-estar e Conveniência

A iluminação liga automaticamente para o nível de luz adequado e desliga quando o espaço estiver desocupado.

### > Higiene e Segurança

Os funcionários não necessitam de tocar em interruptores. Importante para pessoal médico, operários fabris, pessoal de cozinha, etc.

### > Facilidade de Uso

Controlo automático da iluminação.

### > Economia de Energia

A iluminação liga enquanto há pessoas na sala e diminui à medida que os níveis de luz natural aumentam.

### > Controlo Inteligente

A intensidade luminosa é ajustável para responder aos requisitos da aplicação.

## SENSORES INTEGRADOS

Os sensores integrados na luminária são frequentemente uma boa solução para escritórios e outros ambientes de prestígio. Para instalação simples e rápida, a maioria das nossas luminárias podem ser equipadas de série já com sensores incorporados.



# INFINITE DECISIONS

## ACABAMENTO

Apresentamos uma refinada gama de **cores e acabamentos**, que permitem tirar partido do **sentimento** transmitido através da cor e da **sensação** ao toque a diferentes texturas.

A conjugação correta da **cor** ajuda a proporcionar ambientes **coerentes** e esteticamente **atrativos** que podem desencadear várias **emoções** no ser humano: as cores **quentes** proporcionam ambientes **aconchegantes** e **agradáveis**, causam sensações de **conforto, bem-estar** ou **tranquilidade**; enquanto que cores **frias** transmitem um efeito **funcional, limpo** e **modesto**, originando uma sensação de **concentração** ou **alerta** no utilizador.

Conseguimos cumprir com **projetos** que requerem uma grande **personalização** ao nível dos acabamentos. Como opção, é possível conjugar **infinitas combinações** no mesmo produto.

## CORES DISPONÍVEIS

-  > RAL 9003 Branco Mate
-  > Branco Texturado
-  > RAL 9005 Preto Mate
-  > Preto Texturado
-  > RAL 9006 Cinza Alumínio
-  > Alumínio Anodizado Mate
-  > Cinza Metalizado Satinado
-  > Outras Cores - Sob consulta



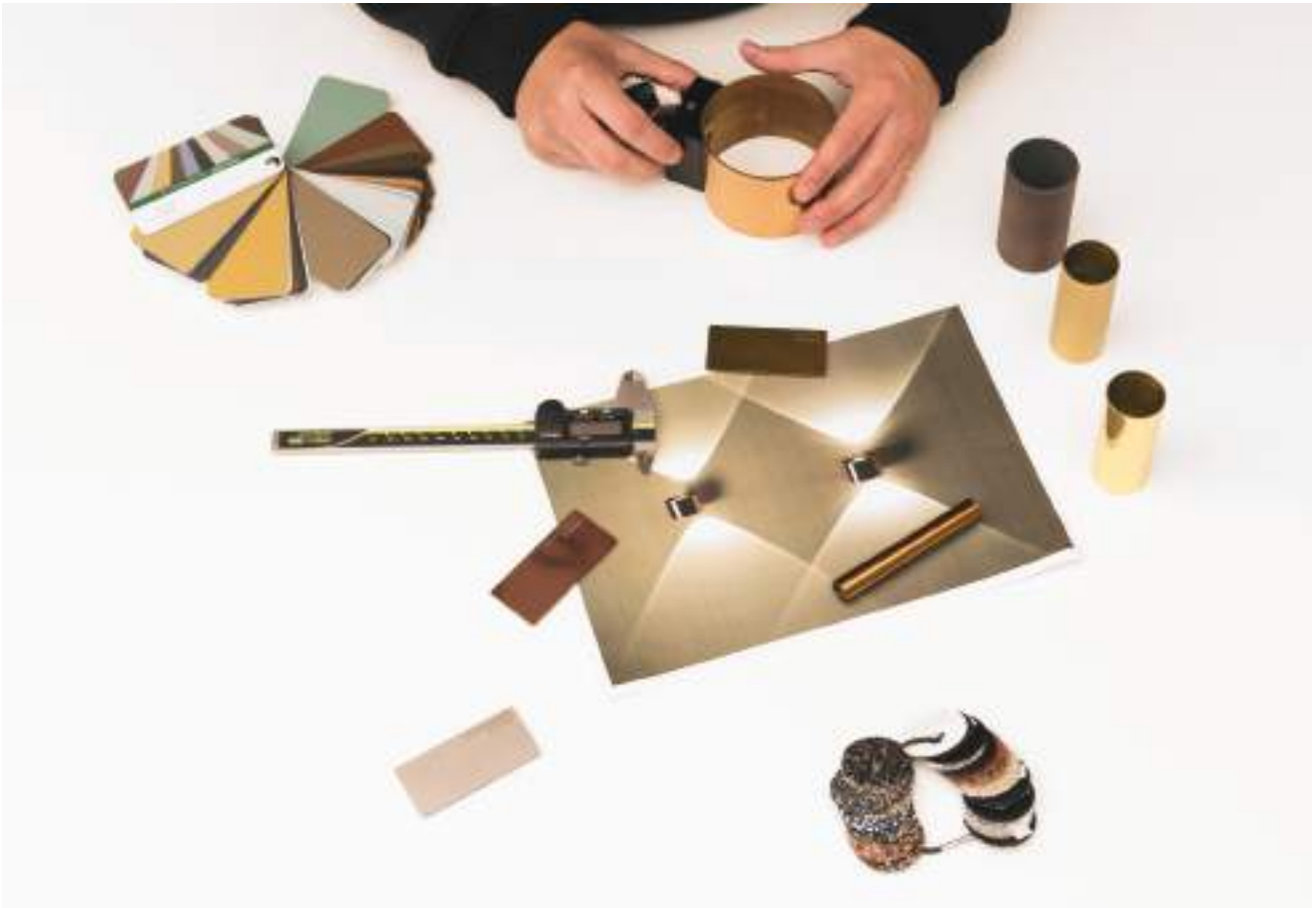

# A-Z

## GENERAL INDEX

### A

	pag
A313 Wall	336
ADAAR 2WD Recessed	366
ADAAR 3WD Recessed	366
ADAAR IP40 Recessed	368
ADAAR IP44 Recessed	368
ADAS 2WD Surface	378
ADAS 3WD Surface	378
ALPHA TRACK Suspended	182
ARES Suspended LD/LI	316
ARES Suspended LI	316
ASEPTIC ADVANCED Recessed	566
ASEPTIC EXTREME Recessed	562
ASEPTIC EXTREME Surface	558
ASEPTIC REGULAR Recessed	570
ASEPTIC WALK-ON Recessed	574
ASTRA 90 Surface Micro Prismatic	082
ASTRA 90 Surface Opal	082
ASTRA 90 Suspended LD Micro Prismatic	066
ASTRA 90 Suspended LD Opal	066
ASTRA 90 Suspended LD/LI Micro Prismatic	074
ASTRA 90 Suspended LD/LI Opal	074
ASTRA 90 Trimless Micro Prismatic	092
ASTRA 90 Trimless Opal	092
ASTRA 150 Surface Opal	086
ASTRA 150 Suspended LD Opal	070
ASTRA 150 Suspended LD/LI Opal	078
ASTRA 150 Trimless Opal	094
ATE IP65 Suspended / Surface	590
ATE IP66 Suspended / Surface	590
ATLAS IP44 Recessed	448
ATLAS RO IP44 Trimless	458
ATLAS SQ IP44 Trimless	460

### B

	pag
BACO IP20 Wall	354
BACO IP44 Wall	354
BERKA Wall	340
BOYA 90 BULBS IN Suspended	056
BOYA 90 BULBS OUT Suspended	058
BOYA 90 DOWN Suspended	036
BOYA 90 IN Suspended	048
BOYA 90 Surface	044
BOYA 90 UP Suspended	034
BOYA 90 UP&DOWN Suspended	038
BOYA 140 Floor	062
BOYA 140 OUT Suspended	052
BOYA 150 UP&DOWN Suspended	040
BRICK FLOOD	680
BRICK H	680

BRICK V	680
---------	-----

### C

	pag
CARDAN Recessed Duo	296
CARDAN Recessed Single	296
CARDAN Surface Duo	292
CARDAN Surface Single	292
CARDAN Suspended Duo	288
CARDAN Suspended Tetra	288
CISTUS Surface	382

### D

	pag
DOUBLE MONO	692
DOURO AP-5 Wall	326
DOURO AP-7 Wall	328
DOURO MC Table Lamp	330
DOURO PA-2 Floor	332
DROP Suspended	170

### E

	pag
ECLIPSE Wall	350
EDBAY RO 2L Suspended	596
EDBAY RO 3L Suspended	596
EDBAY RT 2L Suspended	598
EDBAY RT 3L Suspended	598
EME Recessed	622
EME Surface	620
EME TUBE Surface	618
EME TUBE Suspended	616
EME Wall	624
EME Wall SPO	626
ERGOS H Surface	386
ERGOS L Surface	386
ERUS 25 Suspended	302
ERUS 55 Suspended	306
ERUS 90 Suspended	312

### F

	pag
FACTORY IP54 Suspended / Surface	602
FACTORY IP65 Suspended / Surface	606
FOCUS Suspended	612

### G

	pag
GAP Recessed	194
GAP Trimless	198



GARDEN 30	656
GARDEN 45	658
GARDEN 60	660
GARDEN 120	664

## H

	pag
HIPER EME for Trunking	538
HIPER FIX PANEL for Trunking	514
HIPER IP40 Individual	542
HIPER IP54 Individual	550
HIPER OPTICAL LENS for Trunking	510
HIPER ORIENTABLE PANEL for Trunking	516
HIPER SUSPENDED SPOTS for Trunking	528
HIPER TRACK SPOTS for Trunking	518
HIPER TRUNKING RAIL Continuous Line	508

## I J

	pag
INDI Recessed	374
I-SPOT 90 Orientable Surface	394
I-SPOT 150 RO IP40 Surface	396
I-SPOT 150 RO IP44 Surface	396
I-SPOT 150 SQ IP40 Surface	398
I-SPOT IP20 Surface	392
I-SPOT IP44 Surface	392
I-SPOT RO IP54	676
I-SPOT RO IP65	670
I-SPOT SQ IP54	674

## K

	pag
KAIRO 100	702
KAIRO 120	716
KAIRO 150	716

## L

	pag
LANIN 28	632
LANIN 42	634
LANIN 48	638
LANIN 120	640
LANIN 135	642
LANIN 160	646
LANIN 220	648
LANIN 260	650

## M

	pag
MIRO 60 Track	476

MIRO 80 Track	480
MIRO 90 Track	484
MIRO 100 Track	488
MIRO 130 Track	494
MIRO 140 Track	498

## N

	pag
NAIL	710
NEXUS Wall	346
NIMIX	696

## O P Q R

	pag
ODL-010 PA Wall	358
ODL-015 PA Wall	360
ODL-302	686
ODL-302 SQ	688
OMEGA Recessed	282
OMEGA XS Recessed Micro Prismatic	270
OMEGA XS Recessed Opal	270
OMEGA XS Surface Micro Prismatic	264
OMEGA XS Surface Opal	264
OMEGA XS Suspended Micro Prismatic	256
OMEGA XS Suspended Opal	256
OMEGA XS Trimless Micro Prismatic	276
OMEGA XS Trimless Opal	276

## S

	pag
SILVY Oval Suspended	320
SILVY Round Suspended	320
SNAP MINI Surface	190
SNAP Surface	186
SNAP Suspended LD	174
SNAP Suspended LD/LI	178
SNAP Wall	204
SNAP Wall LD/LI	206
SQUARE 100	706
SQUARE 120	718
SQUARE 150	718
SQUARE-D 150	722
SQUARE-D 220	724
STRETTO Wall	344

## T U

	pag
TALLES 30 RO IN Recessed	402
TALLES 35 RO IP44 Recessed	404
TALLES 42 RO IP65 Recessed	406

# A-Z

## GENERAL INDEX

TALLES 63 RO IN IP20 Trimless	454
TALLES 63 RO IN IP44 Trimless	454
TALLES 70 RO IP20 Recessed	408
TALLES 70 RO IP44 Recessed	408
TALLES 80 RO IN IP20 Recessed	412
TALLES 80 RO IN IP44 Recessed	412
TALLES 80 RO IN IP65 Recessed	412
TALLES 80 SQ IN IP20 Recessed	418
TALLES 80 SQ IN IP44 Recessed	418
TALLES 80 SQ IN IP65 Recessed	418
TALLES 90 RO IP65 Recessed	424
TALLES 90 SQ IP20 Recessed	428
TALLES 90 SQ IP44 Recessed	428
TALLES 130 RO IP44 Recessed	432
TALLES 137 RO IP44 Recessed	436
TALLES 145 SQ IP44 Recessed	440
TALLES 187 RO IP44 Recessed	442
TALLES 200 SQ IP44 Recessed	446
TRACK Recessed	470
TRACK Surface	464
TUPOLI 38 Surface	100
TUPOLI 38 Suspended	098
TUPOLI 55 Suspended	102
TUPOLI 70 I-LIGHT Suspended	110
TUPOLI 70 Surface IP65	584
TUPOLI 70 Surface IP66	584
TUPOLI 70 Suspended	106
TUPOLI 70 Suspended IP65	580
TUPOLI 70 Suspended IP66	580
TUPOLI IP65 COLUMN	728
TUPOLI-360 70 Suspended	120
TUPOLI-360 70 VERTICAL Suspended	124
TUPOLI-V 70 Surface	118
TUPOLI-V 70 Suspended	114
TYOS	712

<b>V X Y</b>	pag
VON BLIND COVER Module	164
VON C-LIGHT Module	138
VON DOUBLE GLOBE Module	156
VON DOUBLE GLOBE S Module	160
VON DOUBLE SPOT Module	148
VON DOUBLE TUBE Module	152
VON H-CORNER	136
VON I-LIGHT Module	140
VON LINEAR Recessed	130
VON LINEAR Surface	130
VON LINEAR Suspended	130
VON LINEAR Trimless	130
VON TRIPLE GLOBE Module	156

VON TRIPLE GLOBE S Module	160
VON TRIPLE SPOT Module	148
VON TRIPLE TUBE Module	152
VON V-CORNER	137
VON V-LIGHT Module	144

<b>W Z</b>	pag
WELINE EDGE Trimless	248
WELINE Recessed Micro Prismatic	238
WELINE Recessed Opal	238
WELINE Surface IP54 Opal	232
WELINE Surface Micro Prismatic	226
WELINE Surface Opal	226
WELINE Suspended IP54 Opal	218
WELINE Suspended LD Micro Prismatic	210
WELINE Suspended LD Opal	210
WELINE Suspended LD/LI Micro Prismatic	222
WELINE Suspended LD/LI Opal	222
WELINE Trimless Micro Prismatic	244
WELINE Trimless Opal	244
WELINE Wall	250



**5** years  
guarantee

**Cinco anos de garantia**

Os produtos Climar beneficiam de uma garantia de cinco anos de acordo com as condições de garantia em [www.climarlighting.com](http://www.climarlighting.com).

As informações contidas neste catálogo referem-se à data de impressão, não são vinculativas e devem ser usadas apenas para fins informativos. Reservamos o direito de fazer alterações aos nossos produtos a qualquer momento. Para obter dados atualizados regularmente, informações técnicas e fotométricas, certificados de qualidade e fichas de produto, por favor consulte a nossa página web em [www.climarlighting.com](http://www.climarlighting.com).

**Este catálogo anula e substitui anteriores edições e pode ser alterado sem aviso prévio.**

## **Agradecimentos**

A Aldeia  
ASD – Soluções de Banho  
Casa da Cultura de Ílhavo  
CascaiShopping  
Centro Comercial Vasco da Gama  
Clark Contracts/Atelier Ten/Spatial Lighting  
District Offices and Lifestyle  
ElectroSport – Bosch Car Service  
Esc. Sec. Gafanha da Nazaré  
F. Fonseca  
Farmácia Giro  
Gelato Davvero  
Laboratório Germano de Sousa  
Going Bike  
Hospital Álvaro Cunheiro  
Hospital Terra Quente  
Hotel 3K Europa  
Hotel Tryp Oriente  
Ivo Tavares Studio  
J.L.Revuelta/Disaro S.L.P.  
João Albano Fernandes, Arquitecto  
João Tiago Aguiar, Arquitectos  
Juicy Oasis Retreat & SPA  
MD Moldes  
Meliá Ria Hotel & SPA  
Metropolitano de Lisboa  
Monte Santo Resort  
Montebelo Vista Alegre Ílhavo Hotel  
NAN Arquitectos  
Nau Hotels & Resorts  
Palácio da Bolsa  
Palácio da Cidadela de Cascais  
PCI · Creative Science Park  
Phive Celas Fitness Club  
Phrame Design, S.L.  
Pizzarte  
Porto Editora  
Praxis  
Ramada Lisbon  
Sonae Sierra  
The Oitavos  
The Yeatman Hotel  
TIL/ARTICA  
Torre dos Clérigos  
Torreão Poente – Terreiro do Paço  
Trastes e Contrastes  
UCC “O Poverello” Montariol  
UCC Oliveira do Bairro  
Von Haff Interior Design

### **Conceito / Design Gráfico**

Climar Lighting

### **Fotografia**

Climar Lighting

### **Impressão**

Orgal Impressores

Copyright © **Climar Lighting**

Todos os direitos reservados.

10.2019 - Revisão

DVM.247.19.1

Para a última edição do Catálogo,  
por favor visite [www.climarlighting.com](http://www.climarlighting.com).

Sinceros agradecimentos às entidades mencionadas pela permissão para publicação de fotos.

we **create** the light of tomorrow



**Climar - Indústria de Iluminação, S.A.**

**Sede**

Rua Estrada Real, 50  
3750-866 Águeda - Portugal

**Escritório Lisboa**

Rua Amorim, 2  
1950-022 Lisboa - Portugal

**t** +351 234 690 330 | **m** +351 915 599 110  
**e** geral@climar.pt

**Escritório Londres**

31 – 35 Kirby Street  
London EC1N 8TE - UK

**t** +44 (0)20 7492 1707 | **m** +44 (0)749 637 8770  
**e** info@climarlighting.co.uk



The interaction  
in a human-light  
relationship  
is settled by the  
attraction of colours,  
touches, and the  
individual feeling  
that **light** gives  
in its presence.



**PT / ES**

Cofinanciado por:



[climarlighting.com](http://climarlighting.com)