

NEWS
2021
COLLECTION
UPDATE

ARKOSLIGHT®

LIGHT&LIFE
— DESDE 1984 —

ARKOSLIGHT®

THE HOME OF LIGHT

ARKOSLIGHT HEADQUARTERS
VALENCIA · SPAIN



HIGHLIGHTS

012

'The Invisible Black', updated

La gama con efecto 'The Invisible Black' ha sido ampliada y mejorada. Presentamos los nuevos Black Foster Micro, Shot Light M Surface y Shot Light M Asymmetric. Además, las actualizaciones: Shot M (más potente), Black Foster (19º) y Shot Light (IP54).

'The Invisible Black' effect range has been expanded and improved. Introducing the new Black Foster Micro, Shot Light M Surface and Shot Light M Asymmetric. In addition, the updates: Shot M (more powerful), Black Foster (19º) and Shot Light (IP54).

La gamme à effet « The Invisible Black » a été élargie et améliorée. Nous présentons les nouveaux Black Foster Micro, Shot Light M Surface et Shot Light M Asymmetric. En outre, les renouvellements : Shot M (plus puissant), Black Foster (19º) et Shot Light (IP54).

La gamma con effetto "The Invisible Black" è stata ampliata e migliorata. Presentiamo i nuovi Black Foster Micro, Shot Light M Surface e Shot Light M Asymmetric. Inoltre, gli aggiornamenti: Shot M (più potente), Black Foster (19º) e Shot Light (IP54).

Das Sortiment mit „The Invisible Black“-Effekt wurde erweitert und verbessert. Wir stellen die neuen Black Foster Micro, Shot Light M Surface und Shot Light M Asymmetric vor. Zusätzliche Updates: Shot M (leistungsfähiger), Black Foster (19º) und Shot Light (IP54).

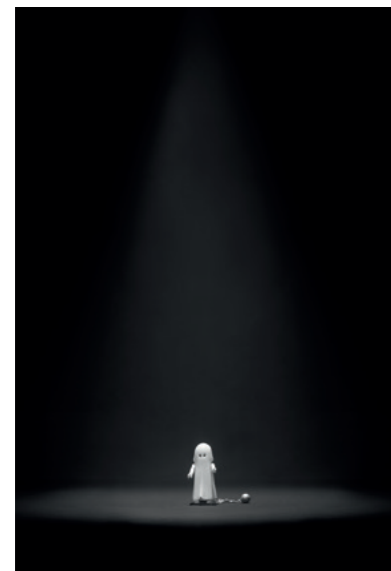

030

Alaska Family

Una atractiva esfera de vidrio macizo seduce a la vista en esta nueva familia de luminarias. Una joya de luz que reinterpreta, con diseño y tecnología, la clásica bombilla de filamento. Para aplicaciones en Minimal Track, superficie, suspensión y Fancy Shape.

An attractive solid glass sphere seduces the eye in this new family of light fittings. A jewel of light that reinterprets, with design and technology, the classic filament bulb. For Minimal Track, Surface, Suspension and Fancy Shape applications.

Une jolie sphère en verre massif qui attire l'attention dans cette nouvelle famille de luminaires. Un joyau de la lumière qui, marqué par le design et la technologie, revisite l'ampoule à filament traditionnelle. Pour des installations sur Minimal Track, plafonnier, suspension et Fancy Shape.

Un'attraente sfera in vetro pieno seduce l'occhio in questa nuova famiglia di lampade. Un gioiello di luce che reinterpreta, con design e tecnologia, la classica lampadina a filamento. Per applicazioni Minimal Track, Surface, Suspension e Fancy Shape.

Eine reizvolle, massive Glaskugel ist der Blickfang in dieser neuen Leuchtenfamilie. Ein Lichtjuwel, das mit Design und Technik die klassische Glühlampe neu interpretiert. Für Minimal Track-, Aufbau-, Pendel- und Fancy Shape-Anwendungen.

042

Fancy Shape

Una nueva familia de luminarias que dibuja formas de expresión en el interiorismo. Las líneas de Fancy Shape diseñan recorridos y composiciones al dictado de la creatividad del arquitecto.

A new family of lights that draw forms of expression in interior design. The lines of Fancy Shape design routes and compositions to the dictates of the architect's creativity.

Une nouvelle famille de luminaires qui crée des formes d'expression dans la décoration d'intérieur. Les lignes de Fancy Shape représentent des trajectoires et des compositions au gré de la créativité de l'architecte.

Una nuova famiglia di lampade che disegnano forme espressive nell'arredamento d'interni. Le linee di Fancy Shape progettano percorsi e composizioni ai dettami della creatività dell'architetto.

Eine neue Familie, die Ausdrucksformen in der Raumgestaltung schafft. Die Produktlinien von Fancy Shape gestalten Designrouten und Lichtkompositionen haargenau gemäß der Kreativität des Architekten.



064

Up

Up es una escultura racional y sobria. Un pie de salón para iluminación indirecta con un gran sentido de verticalidad y ligereza. Diseño formal de pura elegancia.

Up is a rational and sober sculpture. A floor lamp for indirect lighting with a great sense of verticality and lightness. Formal design of pure elegance.

Up est une sculpture rationnelle et sobre. Un lampadaire de salon pour un éclairage indirect doté d'une grande impression de verticalité et de légèreté. Un design raffiné d'une élégance pure.

Up è una scultura razionale e sobria. Una lampada da terra per illuminazione indiretta con un elevato effetto di verticalità e leggerezza. Design formale di pura eleganza.

Up ist eine rationale und schlichte Skulptur. Eine Stehleuchte für indirekte Beleuchtung mit einem großen Bewusstsein für Vertikalität und Leichtigkeit. Formales Design, schlichte Eleganz.

078

Minimal Track Suspension

El perfil ultrafino de Minimal Track, ahora flota en el aire. Una línea que atraviesa la arquitectura suspendida de unos tensores casi invisibles.

Minimal Track's ultra-thin profile now floats in the air. A line that crosses the suspended architecture with almost invisible turnbuckles.

Le profilé ultra fin de Minimal Track flotte à présent dans l'air. Une ligne qui traverse l'architecture suspendue de quelques tendeurs, presque invisibles.

Il profilo ultrasottile di Minimal Track ora galleggia nell'aria. Una linea che attraversa l'architettura sospesa di tensori quasi invisibili.

Das ultradünne Profil von Minimal Track schwebt nun in der Luft. Eine Produktlinie, die über die Architektur hinausgeht und an fast unsichtbaren Spannelementen aufgehängt ist.

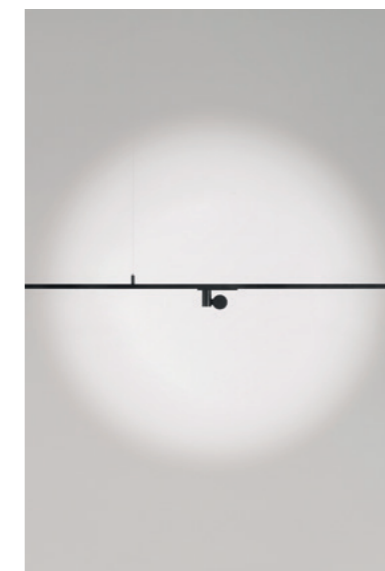

088

Fit 27 24V

Fit 27 ofrece a Minimal Track un proyector de más potencia para incrementar la versatilidad del carril más fino del mercado.

Fit 27 offers Minimal Track a more powerful projector to increase the versatility of the thinnest track on the market.

Fit 27 offre à Minimal Track un projecteur plus puissant pour accroître la polyvalence du rail le plus fin du marché.

Fit 27 offre a Minimal Track un proiettore più potente per aumentare la versatilità del binario più sottile sul mercato.

Fit 27 bietet Minimal Track einen höheren Leistungsprojektor und erhöht so die Vielseitigkeit der dünnsten Schiene auf dem Markt.

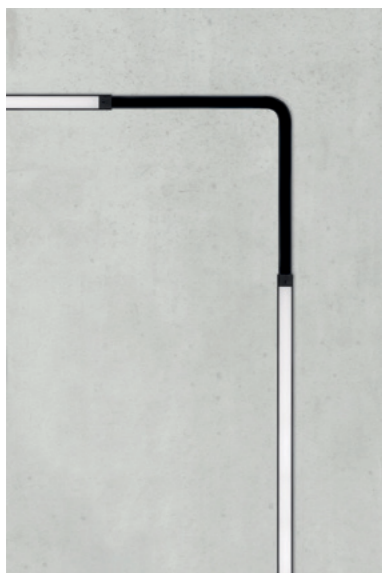

090

Line Micro 24V

Line Micro es un módulo de luz difusa lineal, de tamaño miniaturizado, diseñado para Minimal Track.

Line Micro is a miniaturised linear diffuse light module designed for Minimal Track.

Line Micro est un module de lumière diffuse linéaire, miniaturisé, conçu pour Minimal Track.

Line Micro è un modulo a luce diffusa lineare miniaturizzato progettato per Minimal Track.

Line Micro ist ein Modul für lineares Streulicht in Miniaturgröße, das für Minimal Track entwickelt wurde.

092

Step

Con las nuevas tallas S y XS, Step ofrece puntos de luz señalética más discretos y miniaturizados.

With the new S and XS sizes, Step offers more discreet and miniaturised signal light points.

Avec les nouvelles tailles S et XS, Step offre des points de lumière signalétique plus discrets et miniaturisés.

Con le nuove misure S e XS, Step offre punti luce di segnalazione più discreti e miniaturizzati.

Mit den neuen Größen S und XS bietet Step noch dezentere und miniaturisierte Signallichtpunkte.



096

Wire Trimless Accessories

Ahora las luminarias de suspensión de Arkoslight nacen directamente del techo. Wire Trimless Accessories, minimalismo y pureza visual.

Now Arkoslight pendant lights originate directly from the ceiling. Wire Trimless Accessories, minimalism and visual purity.

Désormais, les luminaires en suspension d'Arkoslight viennent directement du plafond. Wire Trimless Accessories, minimalisme et pureté visuelle.

Ora le lampade a sospensione Arkoslight nascono direttamente dal soffitto. Wire Trimless Accessories, minimalismo e purezza visiva.

Die Pendelleuchten von Arkoslight setzen jetzt direkt an der Decke an. Wire Trimless Accessories, Minimalismus und optische Klarheit.

100

Stick

Stick es la sustentación de la verticalidad pura en una luminaria de suspensión. Sobria individualmente, elegante en composiciones decorativas.

Stick is the substantiation of pure verticality in a pendant light. Individually simple, elegant in decorative compositions.

Stick est la transformation de la verticalité pure en un luminaire en suspension. Sobre individuellement, élégant en compositions décoratives.

Stick è la dimostrazione della pura verticalità in una lampada a sospensione. Singolarmente sobria, elegante nelle composizioni decorative.

Stick ist der Inbegriff reiner Vertikalität in Form einer Pendelleuchte. Individuell schlicht und elegant in dekorativen Kompositionen.



108

Track 48V White

Track 48V está ahora disponible en acabado blanco, con toda una nueva gama de productos diseñados específicamente para combinar con esta nueva terminación.

Track 48V is now available in a white finish, with a whole new range of products specifically designed to match this new finish.

Track 48V est désormais disponible en blanc, avec toute une gamme de produits conçus spécialement pour une combinaison avec cette nouvelle finition.

Track 48V è ora disponibile in una finitura bianca, con una gamma completamente nuova di prodotti appositamente progettati per adattarsi a questa nuova finitura.

Track 48V ist jetzt in weißer Ausführung erhältlich, mit einer ganzen Reihe neuer Produkte, die speziell auf dieses neue Auftreten abgestimmt sind.

110

Fit Gold

Fit está disponible en un nuevo acabado dorado. Mayor calidad percibida, lujo, calidez y confort para el interiorismo.

Fit is available in a new gold finish. Higher perceived quality, luxury, warmth and comfort for interior design.

Fit est disponible dans une nouvelle finition dorée. Meilleure qualité perçue, luxe, chaleur et confort pour la décoration d'intérieur.

Fit è disponibile in una nuova finitura dorata. Maggiore qualità, lusso, calore, comfort per l'arredamento d'interni.

Fit ist in einer neuen goldenen Ausführung erhältlich. Mehr Qualität, die man spürt, Luxus, Wärme und Komfort für die Inneneinrichtung.



ONE COLLECTION

THREE VOLUMES



The 2019 Collection

Versión vigente del catálogo general actual. Empléela para obtener la raíz de los códigos de los productos actualizados en News 2020 y News 2021.

Current version of the contemporary general catalogue. Use it to get the root of the updated product codes in News 2020 and News 2021.

Versión disponible du catalogue général actuel. Utilisez-la pour avoir le début de codes des produits actualisés dans News 2020 et News 2021.

Versione dell'attuale catalogo generale. Usala per ottenere la radice dei codici prodotto aggiornati in News 2020 e News 2021.

Aktuelle Version des aktuellen Gesamtkatalogs. Nutzen Sie ihn, um die ursprünglichen Produkte der in News 2020 und News 2021 aktualisierten Produktcodes zu erhalten.

News 2020 Collection Update

Extensión de catálogo con productos completamente nuevos y luminarias que han sido actualizadas.

Catalogue extension with completely new products and light fittings that have been updated.

Un catalogue complété avec des produits complètement nouveaux et des luminaires renouvelés.

Ampliamento del catalogo con prodotti completamente nuovi e apparecchi che sono stati aggiornati.

Katalogerweiterung mit komplett neuen Produkten und Leuchten, die aktualisiert wurden.

News 2021 Collection Update

Las últimas novedades y actualizaciones del año 2021. Este volumen completa la colección de diseños de Arkoslight.

The latest news and updates for the year 2021. This volume completes the Arkoslight collection of designs.

Les dernières nouveautés et actualisations de 2021. Cette édition complète la collection de designs d'Arkoslight.

Le ultime novità e aggiornamenti del 2021. Questo volume completa la collezione di design Arkoslight.

Die neuesten Nachrichten und Updates für das Jahr 2021. Dieser Band vervollständigt die Arkoslight-Design-Kollektion.

DESIGN SIGN AWARDS

2 DESIGN PLUS



FLAP
2016

LEX ECO
2012

2 GOOD DESIGN



SIX
2018

IO
2017

4 ARCHIPRODUCTS DESIGN AWARDS



MINIMAL TRACK
2020

ART
2019

TOP
2018

POINTER
2017

4 EUROPEAN PRODUCT DESIGN AWARD



MINIMAL TRACK
2020

RHINO
2020

TOP
2019

POP UP
2018

3 FX AWARD



MINIMAL TRACK
2020

ART
2019

PLUS
2019

1 PREMIO BIENAL IBEROAMERICANA DE DISEÑO



ZEN
2014

1 SBID AWARDS



RHINO
2020

1 BOY AWARD



BLACK FOSTER
2019

8 IF DESIGN AWARD



RHINO
2020

BLACK FOSTER
2019

SHOT LIGHT
2017

IO
2017

FLAP
2016

SALT
2015

SLIMGOT
2014

ZEN
2014

9 RED DOT DESIGN AWARD



UP
2021

ALASKA
2021

MINIMAL TRACK
2020 Innovation

MINIMAL TRACK
2020

ART
2019

DRUM
2016

SWAP
2015

LARK-111
2014

SLIMGOT
2014

7 A'DESIGN AWARD



FLAP
2016

DRUM
2016

SPIN
2015

THOR
2015

SKY
2015

DROP
2015

ZEN
2014

9 DELTA AWARDS



ART
2020

MINIMAL TRACK
2020

POINTER
2018

SHOT LIGHT
2018 Selección

IO
2016

AURAE
2014 Selección

STRAM
2014 Selección

ZEN
2013 Selección

LEX ECO
2012 Selección

7 GERMAN DESIGN AWARD



SIX
2019

THOR
2016 Nominee

SPIN
2016 Nominee

SALT
2016 Nominee

SWAP
2016 Nominee

LARK-111
2016 Nominee

SLIMGOT
2016 Nominee

5 ICONIC AWARDS



SHOT LIGHT
2017

PUCK
2017

OLYMPIA
2017 Selection

THOR
2016

SPIN
2016

4 PREMIOS ADCV



PLUS
2019

ART
2019

IO
2017

FLAP
2017

THE
INVISIBLE
BLACK

THE INVISIBLE BLACK

NEW PRODUCTS & UPDATES

BLACK FOSTER

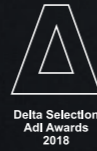

ART



red dot design award
winner 2019

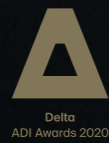

SHOT LIGHT





Power Electronics, Valencia (Spain) | Design: Francesc Rifé Studio | Photography: Héctor Rubio - Images Positive

Gracias a un reflector específicamente diseñado, los rayos de luz no bañan la luminaria y se encauzan directamente al exterior sin tocar la pantalla. Por ello, el efecto 'The Invisible Black' hace que, encendida o apagada, la luminaria conserve siempre la misma apariencia. El origen de la luz no se aprecia desde prácticamente ninguna posición natural del observador, el deslumbramiento se elimina y el confort visual es máximo.

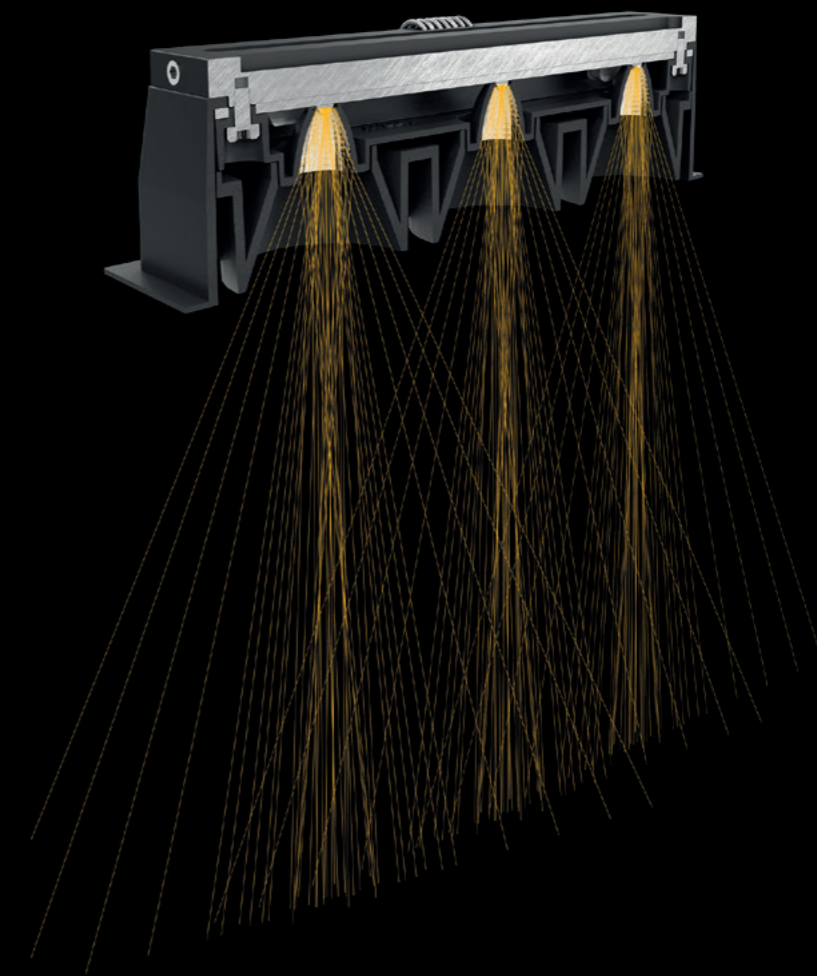

Thanks to a specifically designed reflector, light rays do not bathe the light fitting and are channelled directly to the outside without touching the screen. For this reason, the 'The Invisible Black' effect ensures that, switched on or off, the light fitting always retains the same appearance. The origin of the light is not seen from practically any natural position of the observer, glare is eliminated and visual comfort is maximum.

Grâce à un réflecteur spécialement conçu, les rayons lumineux ne baignent pas le luminaire et sont dirigés directement vers l'extérieur sans effleurer l'abat-jour. C'est pourquoi l'effet « The Invisible Black » permet au luminaire, allumé ou éteint, de conserver toujours la même apparence. La source de lumière est pratiquement imperceptible quelle que soit la position naturelle de l'observateur, l'éblouissement est inexistant et le confort visuel est au plus haut degré.

Grazie ad un riflettore appositamente studiato, i raggi luminosi non irradiano la lampada e vengono convogliati direttamente verso l'esterno senza toccare lo schermo. Per questo l'effetto "The Invisible Black" fa sì che, accesa o spenta, la lampada mantenga sempre lo stesso aspetto. L'origine della luce non si apprezza praticamente da nessuna posizione naturale dell'osservatore, l'abbagliamento è eliminato e il comfort visivo è massimo.

Dank eines speziell entwickelten Reflektors streifen die Lichtstrahlen nicht die Leuchte und werden direkt nach außen geleitet, ohne den Lampenschirm zu berühren. Deshalb sorgt der "The Invisible Black"-Effekt dafür, dass die Leuchte immer gleich aussieht, egal ob sie ein- oder ausgeschaltet ist. Die Lichtquelle ist aus nahezu jeder natürlichen Position des Betrachters nicht sichtbar, Blendung wird vermieden und der Sehkomfort wird maximiert.

BLACK FOSTER MICRO

Black Foster Micro es una proeza de ingeniería que traslada el aclamado efecto 'The Invisible Black' a una luminaria hiper-reducida. Un nuevo producto a la vanguardia de la familia 'The Invisible Black'.

Black Foster Micro is an engineering feat that brings the acclaimed 'The Invisible Black' effect to a hyper-reduced light fitting. A new product at the forefront of the 'The Invisible Black' family.

Black Foster Micro est une prouesse de l'ingénierie qui transmet le célèbre effet « The Invisible Black » à un luminaire extrêmement réduit. Un nouveau produit avant-gardiste de la famille « The Invisible Black ».

Black Foster Micro è un'impresa ingegneristica che trasferisce l'acclamato effetto "The Invisible Black" in una lampada iper-ridotta. Un nuovo prodotto all'avanguardia della famiglia "The Invisible Black".

Black Foster Micro ist eine technische Meisterleistung, die den gefeierten "The Invisible Black"-Effekt in einer hyper-reduzierten Leuchte umsetzt. Ein neues Produkt an der Spitze der "The Invisible Black"-Familie.

BLACK FOSTER
REAL SIZE



BLACK FOSTER MICRO
REAL SIZE





Architecture: Gallardo Llopis Arquitectos | Building Company: BFM Aedificatoria | Photography: Germán Cabo - Fotografía de arquitectura

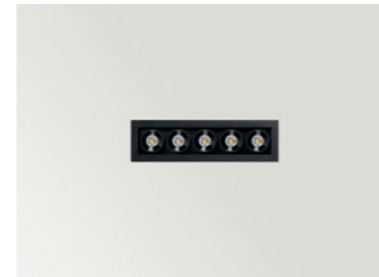

		P	CCT	I	Flux	LOR
BLACK FOSTER MICRO	A414-20- Ⓞ -0- N 	7W	2700K	500mA	775Lm	87%
Recessed 5	A414-20- Ⓞ -1- N 	7W	3000K	500mA	800Lm	87%

LED | 220-240 V~ | CE | IP20 | CRI>90 | L90B10 >60.000h



Ⓞ OPTIONS*

1	No DIM
2	DIM DALI
3	DIM PUSH

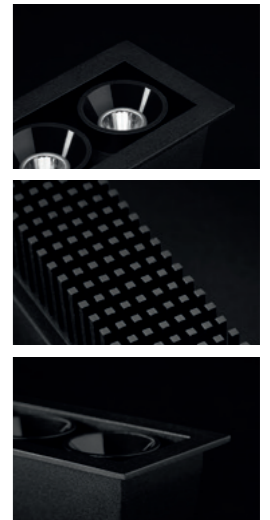
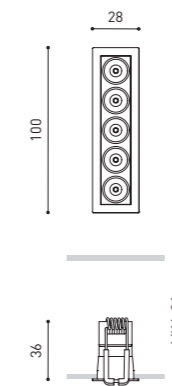

Pending

COLOUR | N ■ | MATERIAL | PC | AL | ABS+PC |

» 120

» PLEASE CONSULT

BLACK FOSTER

NOW 19° SPOT VERSION



House in Santa Barbara, Valencia | Spain | Architecture: Victor García Martínez - Arquitecto | Photography: Hilke Sievers

Black Foster está ahora disponible con una apertura del haz de sólo 19°, para aplicaciones 'spot' con proyección de luz más concentrada.

Black Foster is now available with a beam opening of only 19°, for 'spot' applications with more concentrated light projection.

Black Foster est désormais disponible avec une ouverture du faisceau de 19° seulement, pour des applications « spot » avec une projection de lumière plus ciblée.

Black Foster è ora disponibile con un'apertura del fascio di soli 19°, per applicazioni "spot" con proiezione di luce più concentrata.

Black Foster ist nun mit einem Ausstrahlwinkel von nur 19° erhältlich, für Spotanwendungen mit konzentrierterer Lichtprojektion.

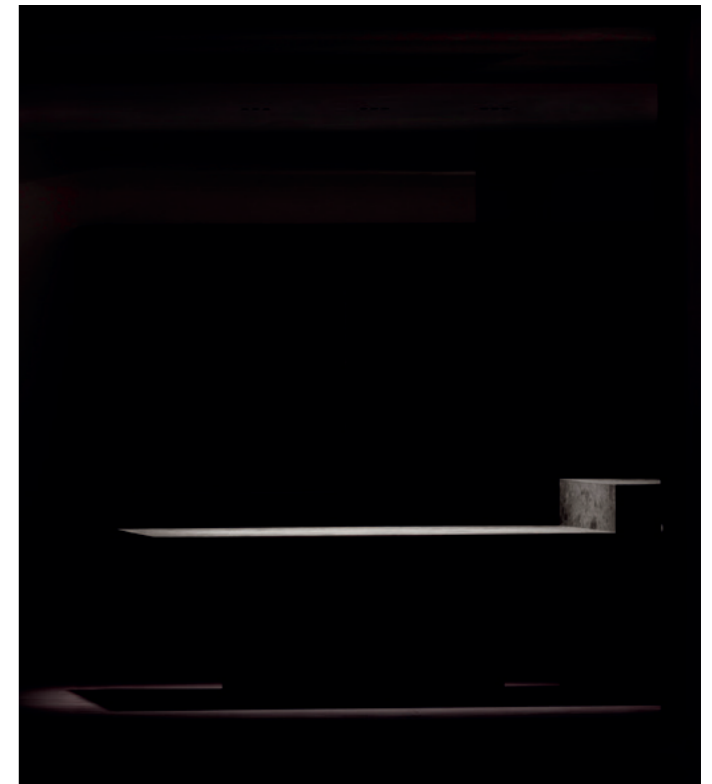
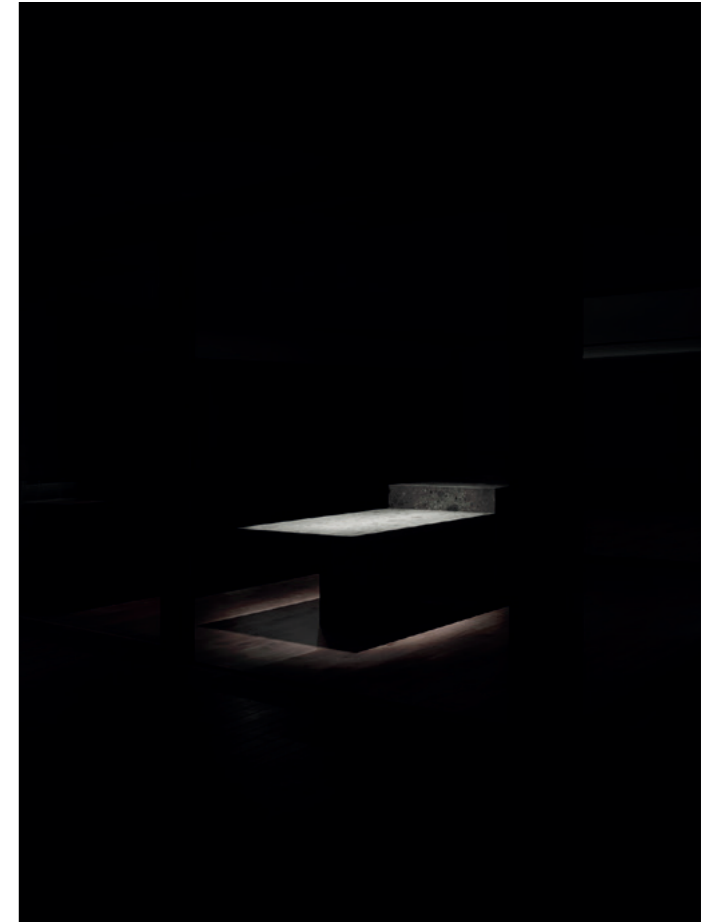

Black Foster Recessed CODE Generator Example

Reference from *The 2019 Collection*

A319 1X 10 N

NEW BEAM

0: 38°

1: 19°

SHOT LIGHT

NOW IP54



Casa Hervás | Architecture: Antonio Alarriba Arquitecto | Photography: Diego Opazo Fotografía

Cuando el entorno de aplicación está expuesto a agua y humedad, Shot Light ofrece ahora una versión de alta estanqueidad IP54.

When the application environment is exposed to water and humidity, Shot Light now offers a version with high IP54 watertightness.

Lorsque l'environnement de l'application est exposé à l'eau et à l'humidité, Shot Light propose à présent une version IP54 hautement étanche.

Quando l'ambiente di applicazione è esposto ad acqua e umidità, Shot Light offre ora una versione con elevata tenuta IP54.

Für den Fall, dass die Anwendungsumgebung Wasser und Feuchtigkeit ausgesetzt ist, bietet Shot Light jetzt eine hochgradig wasserdichte IP54-Version.



New Shot Light IP
CODE Generator Example - Shot Light

Reference from *The 2019 Collection*

A268 0X 20 N

NEW IP
1: IP20
2: IP54

SHOT LIGHT M

MORE POWERFUL

Nueva potencia 3: más flujo luminoso.

New power 3: more light output.

Nouvelle puissance 3 : plus de flux lumineux.

Nuova potenza 3: maggiore resa luminosa.

Neue Leistung 3: mehr Lichtstrom.



Power Electronics, Valencia (Spain) | Design: Francesc Rifé Studio | Photography: Héctor Rubio - Images Positive



		P	CCT	I	Flux	LOR
SHOT LIGHT M 3	A297-03-10- N W NMG WMG	10,3W	2700K	300mA	1230Lm	86%
	A297-03-11- N W NMG WMG	10,3W	3000K	300mA	1280Lm	86%
	A297-03-12- N W NMG WMG	10,3W	4000K	300mA	1300Lm	86%
	A297-03-30- N W NMG WMG	10,3W	2700K	300mA	1230Lm	86%
	A297-03-31- N W NMG WMG	10,3W	3000K	300mA	1280Lm	86%
DALI PUSH*	A297-03-32- N W NMG WMG	10,3W	4000K	300mA	1300Lm	86%

LED | 220-240 V~ | 01 CE | IP20 | CRI>90 | L80B10 >60.000h | MacAdam Step 2 | CONNEX | INCL | Ø75 | UGR <19 | 38°

		P	CCT	I	Flux	LOR
SHOT LIGHT M 3 Trimless	A298-03-10- N W NMG	10,3W	2700K	300mA	1230Lm	86%
	A298-03-11- N W NMG	10,3W	3000K	300mA	1280Lm	86%
	A298-03-12- N W NMG	10,3W	4000K	300mA	1300Lm	86%
	A298-03-30- N W NMG	10,3W	2700K	300mA	1230Lm	86%
	A298-03-31- N W NMG	10,3W	3000K	300mA	1280Lm	86%
DALI PUSH*	A298-03-32- N W NMG	10,3W	4000K	300mA	1300Lm	86%

LED | 220-240 V~ | 01 CE | IP20 | CRI>90 | L80B10 >60.000h | MacAdam Step 2 | EXCL** | CONNEX | INCL | Ø85 | UGR <19 | 38°

ACCESSORIES

SHOT LIGHT M High Chromatic LED

NOT SOLD SEPARATELY | AFFECTS THE LIGHTING PARAMETERS



SHOT LIGHT M Trimless Accessory** A298-00-00

** MANDATORY FOR INSTALLATION

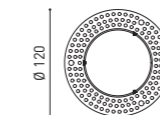

SHOT LIGHT M

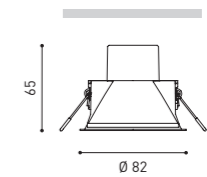
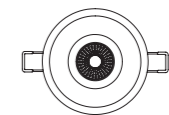

SHOT LIGHT M TRIMLESS

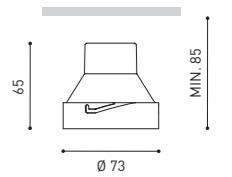
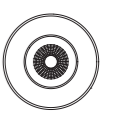

COLOUR | N ■ | W □ | NMG ■■ | WMG □□ | MATERIAL | AL | ABS+PC | RAL ⓘ » 120

* OTHER DIM OPTIONS PLEASE CONSULT

Bluetooth & DALI » PLEASE CONSULT

SHOT LIGHT M

ASYMMETRIC

Nuevo modelo asimétrico, con efecto 'The Invisible Black'.

New asymmetrical model, with 'The Invisible Black' effect.

Nouveau modèle asymétrique, avec effet « The Invisible Black ».

Nuovo modello asimmetrico, con effetto "The Invisible Black".

Neues asymmetrisches Modell mit "The Invisible Black"-Effekt.



		P	CCT	I	Flux	LOR
SHOT LIGHT M 1 Asymmetric	A297-11-10- N W	5W	2700K	150mA	675Lm	83%
	A297-11-11- N W	5W	3000K	150mA	700Lm	83%
	A297-11-12- N W	5W	4000K	150mA	710Lm	83%
SHOT LIGHT M 2 Asymmetric	A297-12-10- N W	6,5W	2700K	200mA	910Lm	83%
	A297-12-11- N W	6,5W	3000K	200mA	940Lm	83%
	A297-12-12- N W	6,5W	4000K	200mA	960Lm	83%
SHOT LIGHT M 3 Asymmetric	A297-13-10- N W	10,3W	2700K	300mA	1230Lm	83%
	A297-13-11- N W	10,3W	3000K	300mA	1280Lm	83%
	A297-13-12- N W	10,3W	4000K	300mA	1300Lm	83%
	A297-13-30- N W	10,3W	2700K	300mA	1230Lm	83%
	A297-13-31- N W	10,3W	3000K	300mA	1280Lm	83%
	A297-13-32- N W	10,3W	4000K	300mA	1300Lm	83%

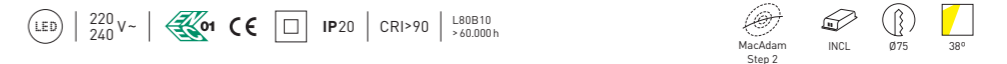

		P	CCT	I	Flux	LOR
SHOT LIGHT M 1 Asymmetric Trimless	A298-11-10- N W	5W	2700K	150mA	675Lm	83%
	A298-11-11- N W	5W	3000K	150mA	700Lm	83%
	A298-11-12- N W	5W	4000K	150mA	710Lm	83%
SHOT LIGHT M 2 Asymmetric Trimless	A298-12-10- N W	6,5W	2700K	200mA	910Lm	83%
	A298-12-11- N W	6,5W	3000K	200mA	940Lm	83%
	A298-12-12- N W	6,5W	4000K	200mA	960Lm	83%
SHOT LIGHT M 3 Asymmetric Trimless	A298-13-10- N W	10,3W	2700K	300mA	1230Lm	83%
	A298-13-11- N W	10,3W	3000K	300mA	1280Lm	83%
	A298-13-12- N W	10,3W	4000K	300mA	1300Lm	83%
	A298-13-30- N W	10,3W	2700K	300mA	1230Lm	83%
	A298-13-31- N W	10,3W	3000K	300mA	1280Lm	83%
	A298-13-32- N W	10,3W	4000K	300mA	1300Lm	83%

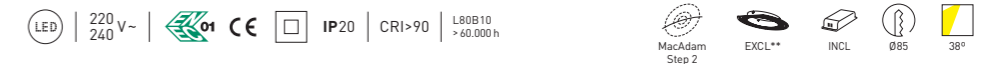

ACCESSORIES

SHOT LIGHT M High Chromatic LED

NOT SOLD SEPARATELY | AFFECTS THE LIGHTING PARAMETERS



SHOT LIGHT M Trimless Accessory** A298-10-00

** MANDATORY FOR INSTALLATION

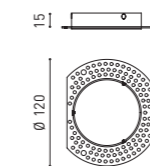

SHOT LIGHT M ASYMMETRIC

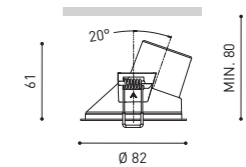
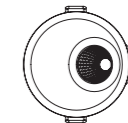

SHOT LIGHT M ASYMMETRIC TRIMLESS

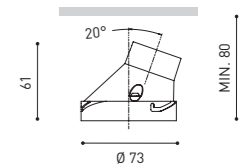
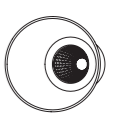

COLOUR | N ■ | W □ |

MATERIAL | AL | ABS+PC |

RAL ⓘ » 120

* OTHER DIM OPTIONS PLEASE CONSULT

» PLEASE CONSULT

SHOT LIGHT M

SURFACE



'The Invisible Black', ahora en una nueva luminaria para superficie.

'The Invisible Black', now in a new surface-mounted light fitting.

« The Invisible Black », désormais dans un nouveau luminaire plafonnier.

"The Invisible Black", ora in una nuova lampada da superficie.

"The Invisible Black" jetzt in einer neuen Anbauleuchte.



		CCT	Beam	LOR
SHOT LIGHT M	A396-00-10- WT NT MG MC NTMG WTW	2700K	38°	86%
Surface	A396-00-11- WT NT MG MC NTMG WTW	3000K	38°	86%
	A396-00-12- WT NT MG MC NTMG WTW	4000K	38°	86%

LED | CE | III | IP20 | CRI>90 | L80B10 >60.000h



DRIVER OPTIONS*	P	I	CCT	Flux
On/Off 0434-00-36	4,5W	140mA	2700K	660Lm
			3000K	690Lm
			4000K	700Lm
0434-00-37	6,5W	200mA	2700K	910Lm
			3000K	940Lm
			4000K	960Lm
0434-00-39	12,4W	350mA	2700K	1470Lm
			3000K	1530Lm
			4000K	1550Lm
0434-00-79	12,4W	350mA	2700K	1470Lm
			3000K	1530Lm
			4000K	1550Lm



DRIVER MUST BE PLACED ON REMOTE

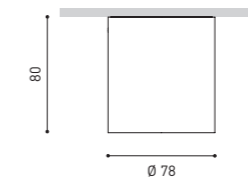

FINISHING**	Body	Lampshade
WT	WT □	N ■
NT	NT ■	N ■
MG	MG ■	N ■
MC	MC ■	N ■
NTMG	NT ■	MG ■
WTW	WT □	W □

COLOUR | WT □ | NT ■ | MG ■ | MC ■ | NTMG ■ | WTW □ | MATERIAL | AL | PC | RAL ⓘ » 120

** OTHER FINISHING COMBINATIONS PLEASE CONSULT

ALASKA FAMILY

Alaska, la joya esférica de luz. La reinterpretación moderna, desde la tecnología y el diseño, de la clásica bombilla de filamento. Una esfera mágica de vidrio macizo que posee un atractivo magnético e inexplicable.

Alaska, the spherical jewel of light. The modern reinterpretation, from technology and design, of the classic filament light bulb. A magical solid glass sphere that has an inexplicable and magnetic appeal.

Alaska, le bijou sphérique de la lumière. Design et technologie dans la réinterprétation moderne de l'ampoule à filament traditionnelle. Une sphère magique en verre massif qui possède un charme magnétique et inexplicable.

Alaska, il gioiello sferico di luce. La rivisitazione in chiave moderna, tra tecnologia e design, della classica lampadina a filamento. Una sfera magica di vetro pieno che ha un fascino inspiegabile e magnetico.

Alaska, das sphärische Juwel des Lichts. Die moderne Neuinterpretation der klassischen Glühlampe in Sachen Technik und Design. Eine massive Glaskugel, die eine magnetische und unerklärliche Anziehungskraft besitzt.



reddot winner 2021
lighting design



Design: Pepe Cabrera Arquitectura | Photography: Adrián Mora Maroto

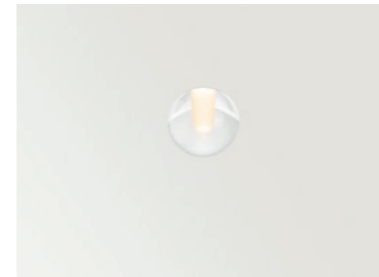

		P	CCT	Flux	LOR
ALASKA Trimless	A401-00-00- N	4,5W	2700K	475Lm	30%
	A401-00-01- N	4,5W	3000K	500Lm	30%

| | | IP20 | CRI>90 | L80B10 >60.000h

DRIVER OPTIONS*		P	I	
On/Off	0434-00-42	4,5W	500mA	1 to 4 Alaska Trimless
	0434-00-44	4,5W	500mA	1 to 4 Alaska Trimless

DRIVER MUST BE PLACED ON REMOTE

ACCESSORY

Alaska Trimless Accessory**	A401-10-00
-----------------------------	------------

MANDATORY FOR INSTALLATION



ALASKA TRIMLESS

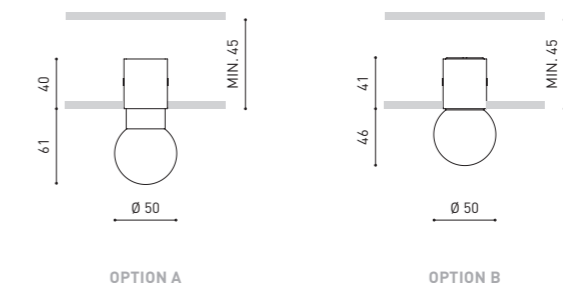

COLOUR | N ■ | MATERIAL | AL | OPTICAL GLASS |

» 120

» PLEASE CONSULT



Architecture: Gallardo Llopis Arquitectos | Building Company: BFM Aedificatoria | Photography: Germán Cabo - Fotografía de arquitectura



		P	CCT	I	Flux	LOR
ALASKA BIG	A426-00- 0-0- N	9,3W	2700K	550mA	1130Lm	37%
Trimless	A426-00- 0-1- N	9,3W	3000K	550mA	1200Lm	37%

LED | 220-240 V~ | CE | IP20 | CRI>90 | L90B10 >60.000h



00 OPTIONS*

1	No DIM
2	DIM DALI
3	DIM PUSH

ACCESSORY

ALASKA BIG Trimless Accessory** A426-10-00

MANDATORY FOR INSTALLATION



ALASKA BIG TRIMLESS

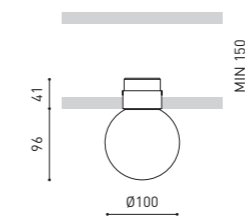

COLOUR | N ■ | MATERIAL | AL | OPTICAL GLASS |

* OTHER K & DIM OPTIONS PLEASE CONSULT

» 120

» PLEASE CONSULT



Architecture: Gallardo Lupis Arquitectos | Building Company: BFM Aedificatoria | Photography: Germán Cabo - Fotografía de arquitectura



		P	CCT	I	Flux	LOR
ALASKA	A425- 00-0-10- N BG	4,5W	2700K	500mA	475Lm	30%
	A425- 00-0-11- N BG	4,5W	3000K	500mA	500Lm	30%
	A425- 00-0-20- N BG	4,5W	2700K	500mA	475Lm	30%
	 A425- 00-0-21- N BG	4,5W	3000K	500mA	500Lm	30%

LED | 220-240 V~ | CE | IP20 | CRI>90 | L80B10 >60.000h



00 CORD LENGTH - L

0	2 m
2	5 m

Other length please consult

FINISHING*	Lamp	Base
	N ■ NT ■	■
	BG ■ NT ■	■

OPTIONAL ACCESSORY

Cord Accessory

0223-00-00- | N |

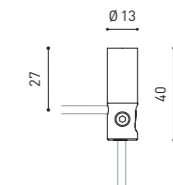

ALASKA SUSPENSION

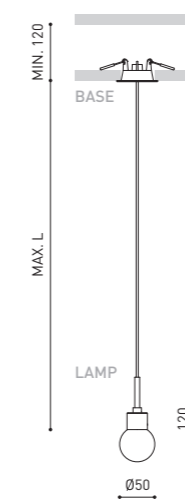

ALASKA + CORD ACCESSORY

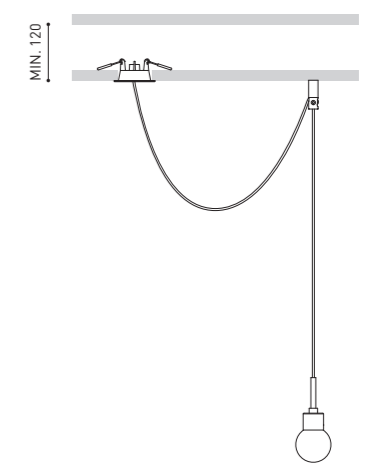

COLOUR | N ■ | NT ■ | BG ■

MATERIAL | AL | OPTICAL GLASS

RAL ⓘ » 120

OTHER K & DIM OPTIONS PLEASE CONSULT | * OTHER FINISHING COMBINATIONS PLEASE CONSULT

» PLEASE CONSULT



		P	CCT	I	Flux	LOR
ALASKA BIG	A428- ☉ -0-10- N BG	9,3W	2700K	550mA	1130Lm	37%
	A428- ☉ -0-11- N BG	9,3W	3000K	550mA	1200Lm	37%
	A428- ☉ -0-20- N BG	9,3W	2700K	550mA	1130Lm	37%
	 A428- ☉ -0-21- N BG	9,3W	3000K	550mA	1200Lm	37%

LED | 220-240 V~ | CE | IP20 | CRI>90 | L90B10 >60.000h



☉ CORD LENGTH - L1 + L2

1	3 m
2	5 m

Other length please consult

OPTIONAL ACCESSORIES

Cord Accessory 0223-00-00- | N |

Included 1 unit x lamp

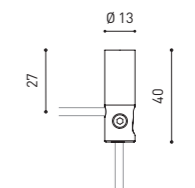

Cord Accessory One Plane 0224-00-00- | N |

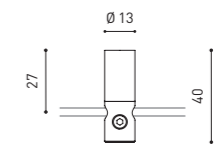

ALASKA BIG

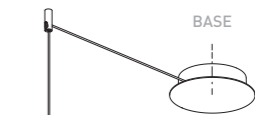
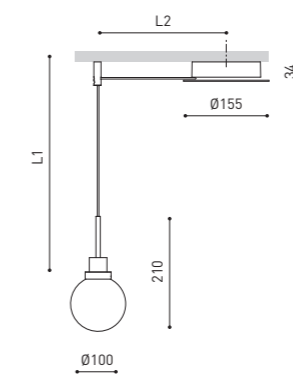

FINISHING*	Lamp	Base
N	■	NT ■
BG	■	NT ■

COLOUR | N ■ | NT ■ | BG ■

MATERIAL | AL | OPTICAL GLASS |

RAL ⓘ » 120

OTHER K & DIM OPTIONS PLEASE CONSULT | * OTHER FINISHING COMBINATIONS PLEASE CONSULT

» PLEASE CONSULT





FANCY SHAPE

Fancy Shape es una colección de productos que permite al arquitecto configurar y distribuir las luminarias en el espacio con total libertad, dibujando trazados y composiciones desde una discreta base de superficie. Con Fancy Shape, el diseño de los puntos de luz es tan versátil como la necesidad del proyecto.

Fancy Shape is a collection of products that allows the architect to configure and distribute the light fittings in the space with total freedom, drawing layouts and compositions from a discreet surface base. With Fancy Shape, the design of the light points is as versatile as the requirements of the project.

Fancy Shape est une collection de produits qui permet à l'architecte de configurer et de répartir les luminaires dans l'espace en toute liberté, en dessinant des lignes et des compositions à partir d'une base de surface discrète. Avec Fancy Shape, le design des sources de lumière est aussi polyvalent que le besoin du projet.

Fancy Shape è una collezione di prodotti che permette di configurare e distribuire le lampade nello spazio in totale libertà, disegnando tracciati e composizioni da una base di superficie discreta. Con Fancy Shape, il design dei punti luce è versatile quanto le esigenze del progetto.

Fancy Shape ist eine Produktkollektion, die es dem Architekten ermöglicht, die Leuchten mit völliger Freiheit im Raum zu konfigurieren und zu verteilen, indem er Layouts und Kompositionen von einer diskreten Aufputzbasis aus zeichnet. Bei Fancy Shape ist das Design der Lichtpunkte so vielseitig wie der Bedarf des Projekts.



MANDATORY FOR INSTALLATION

FANCY SHAPE BASE 2 500mA 1 to 2 Lamps

A417-01-11- | WT | NT |
 DALI A417-01-12- | WT | NT |

2 Equidistant Fixing Points



FANCY SHAPE BASE 6 500mA 3 to 6 Lamps

A417-01-31- | WT | NT |
 DALI A417-01-32- | WT | NT |

6 Equidistant Fixing Points

FANCY SHAPE BASE 12 500mA 7 to 12 Lamps

A417-01-51- | WT | NT |
 DALI A417-01-52- | WT | NT |

12 Equidistant Fixing Points

220 V~ | CE | IP20 | INCL



		P	CCT	I	Flux	LOR
ALASKA	A418- 00-00- N BG	4,5W	2700K	500mA	475Lm	30%
Fancy Shape	A418- 00-01- N BG	4,5W	3000K	500mA	500Lm	30%

CE | IP20 | CRI>90 | L80B10 >60.000h

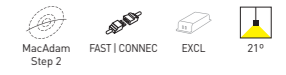

00 CORD LENGTH - L1 + L2

0	2 m
2	5 m

Other length please consult

OPTIONAL ACCESSORIES
Cord Accessory 0223-00-00- | N |
 Included 1 unit x lamp

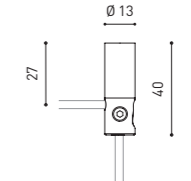

Cord Accessory One Plane 0224-00-00- | N |

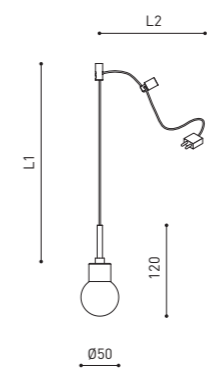
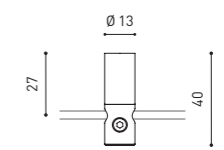

ALASKA Fancy Shape
Application example 2 Lamps

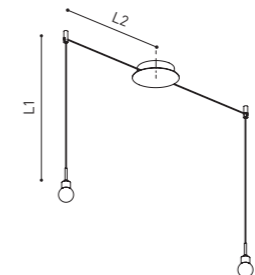

ALASKA Fancy Shape
Application example 6 Lamps

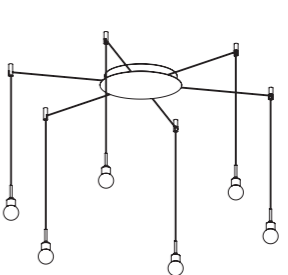

ALASKA Fancy Shape
Application example 12 Lamps

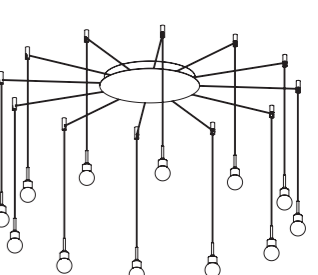

COLOUR | N ■ | BG ■ | WT □ | NT ■ | MATERIAL | AL | OPTICAL GLASS | RAL ⓘ » 120
 OTHER K & DIM OPTIONS PLEASE CONSULT | OTHER FINISHING COMBINATIONS PLEASE CONSULT ⓘ » PLEASE CONSULT



Architecture: H20 + Studio G6SV | Photography: Thibaut Voisin - Photographe



MANDATORY FOR INSTALLATION

FANCY SHAPE BASE 2 550mA 1 to 2 Lamps

A417-02-11- | WT | NT |

DALI A417-02-12- | WT | NT |

2 Equidistant Fixing Points



FANCY SHAPE BASE 3 550mA 3 Lamps

A417-02-21- | WT | NT |

DALI A417-02-22- | WT | NT |

6 Equidistant Fixing Points

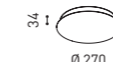

FANCY SHAPE BASE 6 550mA 4 to 6 Lamps

A417-02-31- | WT | NT |

DALI A417-02-32- | WT | NT |

12 Equidistant Fixing Points

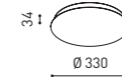

220 V~ | CE | IP20 | INCL



WT

NT

		P	CCT	I	Flux	LOR
ALASKA BIG	A419- 00-00- N BG	9,3W	2700K	550mA	1130Lm	37%
Fancy Shape	A419- 00-01- N BG	9,3W	3000K	550mA	1200Lm	37%

CE | IP20 | CRI>90 | L90B10 >60.000h



00 CORD LENGTH - L1 + L2

1	3 m
2	5 m

Other length please consult

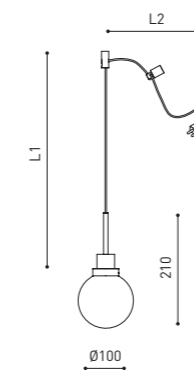

OPTIONAL ACCESSORIES

Cord Accessory 0223-00-00- | N |

Included 1 unit x lamp

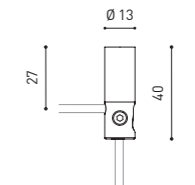

Cord Accessory One Plane 0224-00-00- | N |

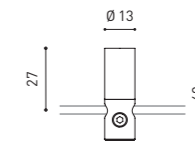

ALASKA BIG Fancy Shape Application example 2 Lamps

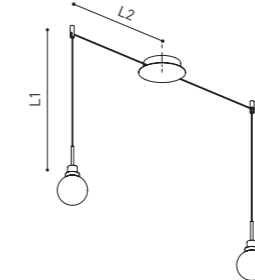

ALASKA BIG Fancy Shape Application example 3 Lamps

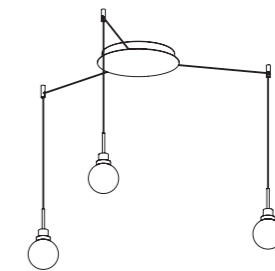

ALASKA BIG Fancy Shape Application example 6 Lamps

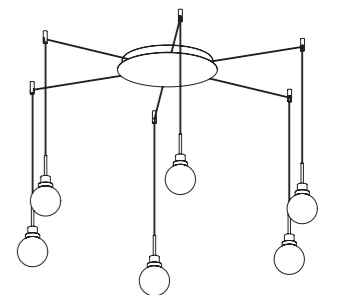

COLOUR | N ■ | BG ■ | WT □ | NT ■ | MATERIAL | AL | OPTICAL GLASS | RAL ⓘ » 120

OTHER K & DIM OPTIONS PLEASE CONSULT | OTHER FINISHING COMBINATIONS PLEASE CONSULT

» PLEASE CONSULT



Architecture: Ambau Taller d'Arquitectes | Photography: Germán Cabo - Fotografía de arquitectura



MANDATORY FOR INSTALLATION

FANCY SHAPE BASE 2 700mA 1 to 2 Lamps

A417-03-11- | WT | NT |

DALI A417-03-12- | WT | NT |

2 Equidistant Fixing Points



FANCY SHAPE BASE 6 700mA 3 to 6 Lamps

A417-03-21- | WT | NT |

DALI A417-03-22- | WT | NT |

6 Equidistant Fixing Points



FANCY SHAPE BASE 12 700mA 7 to 12 Lamps

A417-03-31- | WT | NT |

DALI A417-03-32- | WT | NT |

12 Equidistant Fixing Points



220 V~ | CE | IP20 | INCL



		P	CCT	Beam	I	Flux	LOR
SPIN	A420- -0-00- NT MC MG	6,5W	2700K	24°	700mA	600Lm	86%
Fancy Shape	A420- -0-01- NT MC MG	6,5W	3000K	24°	700mA	630Lm	86%
	A420- -0-10- NT MC MG	6,5W	2700K	40°	700mA	600Lm	84%
	A420- -0-11- NT MC MG	6,5W	3000K	40°	700mA	630Lm	84%

CE | IP20 | CRI>90 | L80B10 >60.000h



CORD LENGTH - L1 + L2

0	2 m
1	3 m
2	5 m

Other length please consult

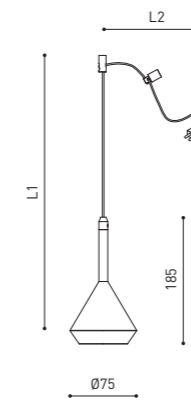

OPTIONAL ACCESSORIES

Cord Accessory 0223-00-00- | N |

Included 1 unit x lamp

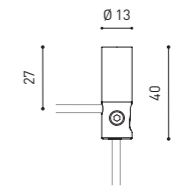

Cord Accessory One Plane 0224-00-00- | N |

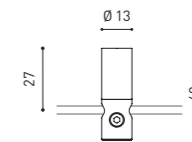

SPIN Fancy Shape
Application example 2 Lamps

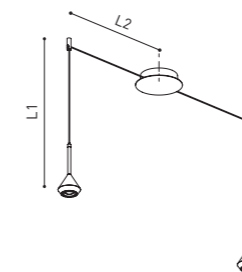

SPIN Fancy Shape
Application example 6 Lamps

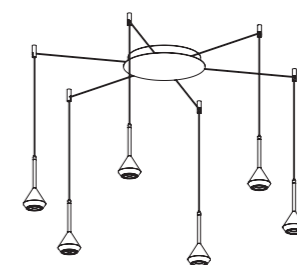

SPIN Fancy Shape
Application example 12 Lamps

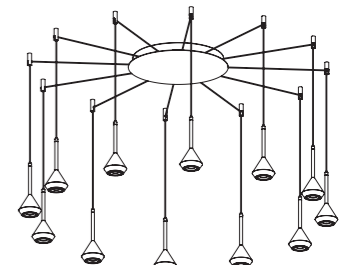

COLOUR | WT □ | NT ■ | MC ■ | MG ■ | N ■ | MATERIAL | AL | PMMA | RAL ⓘ » 120

OTHER K & DIM OPTIONS PLEASE CONSULT | OTHER FINISHING COMBINATIONS PLEASE CONSULT

» PLEASE CONSULT





Architecture: Ambau Taller d'Arquitectes | Photography: Germán Cabo - Fotografía de arquitectura



MANDATORY FOR INSTALLATION

FANCY SHAPE BASE 2 700mA 1 to 2 Lamps

A417-03-11- | WT | NT |

DALI A417-03-12- | WT | NT |

2 Equidistant Fixing Points



FANCY SHAPE BASE 6 700mA 3 to 6 Lamps

A417-03-21- | WT | NT |

DALI A417-03-22- | WT | NT |

6 Equidistant Fixing Points

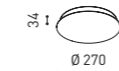

FANCY SHAPE BASE 12 700mA 7 to 12 Lamps

A417-03-31- | WT | NT |

DALI A417-03-32- | WT | NT |

12 Equidistant Fixing Points

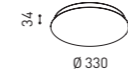

220 V~ | CE | IP20 | INCL



		P	CCT	Beam	I	Flux	LOR
HOLLY Fancy Shape	A421- 00-00- NT MC MG	2,1W	2700K	19°	700mA	190Lm	90%
	A421- 00-01- NT MC MG	2,1W	3000K	19°	700mA	210Lm	90%
	A421- 00-10- NT MC MG	2,1W	2700K	38°	700mA	190Lm	92%
	A421- 00-11- NT MC MG	2,1W	3000K	38°	700mA	210Lm	92%

CE | IP20 | CRI>90 | L80B10 >60.000h



CORD LENGTH - L1 + L2

0	2 m
1	3 m
2	5 m

Other length please consult

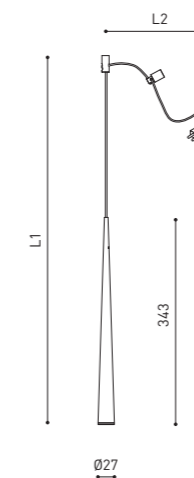

OPTIONAL ACCESSORIES

Cord Accessory 0223-00-00- | N |

Included 1 unit x lamp

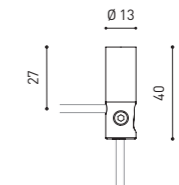

Cord Accessory One Plane 0224-00-00- | N |

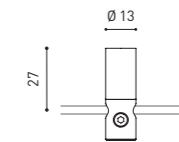

HOLLY Fancy Shape
Application example 2 Lamps

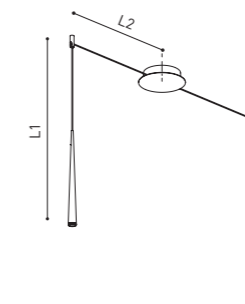

HOLLY Fancy Shape
Application example 6 Lamps

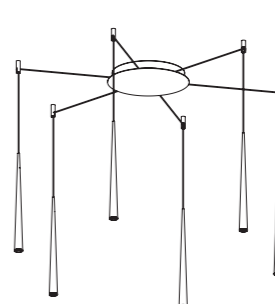

HOLLY Fancy Shape
Application example 12 Lamps

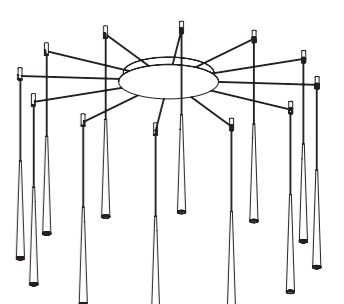

COLOUR | WT □ | NT ■ | MC ■ | MG ■ | N ■ | MATERIAL | AL | ABS | RAL ⓘ » 120

OTHER K & DIM OPTIONS PLEASE CONSULT | OTHER FINISHING COMBINATIONS PLEASE CONSULT

» PLEASE CONSULT





Architecture: H20 + Studio G6SV | Photography: Thibaut Voisin - Photographe



MANDATORY FOR INSTALLATION

FANCY SHAPE BASE 2 500mA 1 to 2 Lamps

A417-01-11- | WT | NT |

DALI A417-01-12- | WT | NT |

2 Equidistant Fixing Points



FANCY SHAPE BASE 5 500mA 3 to 5 Lamps

A417-01-21- | WT | NT |

FANCY SHAPE BASE 6 500mA 3 to 6 Lamps

DALI A417-01-32- | WT | NT |

6 Equidistant Fixing Points

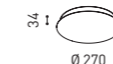

FANCY SHAPE BASE 10 500mA 6 to 10 Lamps

A417-01-41- | WT | NT |

FANCY SHAPE BASE 12 500mA 7 to 12 Lamps

DALI A417-01-52- | WT | NT |

12 Equidistant Fixing Points

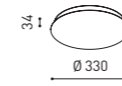

220 V~ | IP20 | INCL



		P	CCT	Beam	I	Flux	LOR
STICK Fancy Shape	A42- ○ - ○ -0-10- WT NT MG	5,6W	2700K	22°	500mA	530Lm	84%
	A42- ○ - ○ -0-11- WT NT MG	5,6W	3000K	22°	500mA	600Lm	84%
	A42- ○ - ○ -0-20- WT NT MG	5,6W	2700K	37°	500mA	530Lm	82%
	A42- ○ - ○ -0-21- WT NT MG	5,6W	3000K	37°	500mA	600Lm	82%
	A42- ○ - ○ -0-30- WT NT MG	5,6W	2700K	46°	500mA	530Lm	81%
	A42- ○ - ○ -0-31- WT NT MG	5,6W	3000K	46°	500mA	600Lm	81%

IP20 | CRI>90 | L80B10 >60.000h



○	STICK LENGTH	
2	STICK 22	220 mm
3	STICK 44	440 mm
4	STICK 66	660 mm

⊙	CORD LENGTH - L1 + L2	
0	2 m	
2	5 m	

Other length please consult

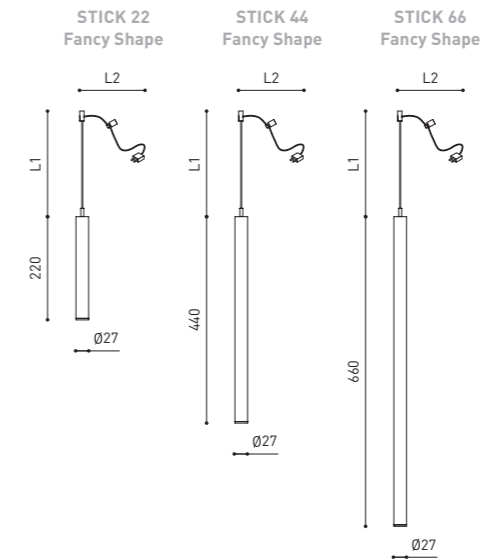

OPTIONAL ACCESSORIES

Cord Accessory 0223-00-00- | N |
Included 1 unit x lamp

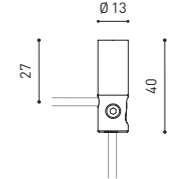

Cord Accessory One Plane 0224-00-00- | N |

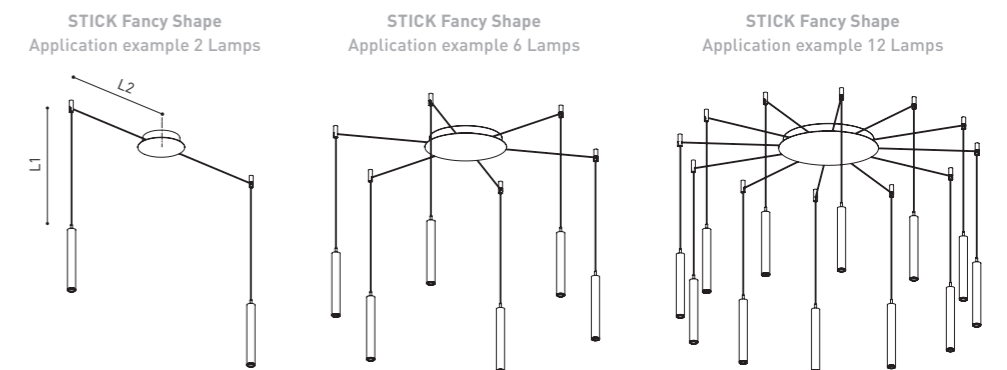
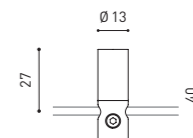

COLOUR | WT | NT | MG | N | MATERIAL | AL | ABS+PC | RAL » 120

OTHER K & DIM OPTIONS PLEASE CONSULT | OTHER FINISHING COMBINATIONS PLEASE CONSULT

» PLEASE CONSULT



Architecture: Gallardo Llopis Arquitectos | Building Company: BFM Aedificatoria | Photography: Germán Cabo - Fotografía de arquitectura



MANDATORY FOR INSTALLATION

FANCY SHAPE BASE 2 700mA 1 to 2 Lamps

A417-03-11- | WT | NT |

DALI A417-03-12- | WT | NT |

2 Equidistant Fixing Points



FANCY SHAPE BASE 6 700mA 3 to 6 Lamps

A417-03-21- | WT | NT |

DALI A417-03-22- | WT | NT |

6 Equidistant Fixing Points

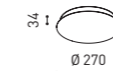

FANCY SHAPE BASE 12 700mA 7 to 12 Lamps

A417-03-31- | WT | NT |

DALI A417-03-32- | WT | NT |

12 Equidistant Fixing Points

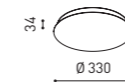

220 V~ | IP20 | INCL



		P	CCT	Beam	I	Flux	LOR
TOP Fancy Shape	A427- -0-10- NT	6,5W	2700K	20°	700mA	610Lm	92%
	A427- -0-11- NT	6,5W	3000K	20°	700mA	640Lm	92%
	A427- -0-12- NT	6,5W	4000K	20°	700mA	655Lm	92%
	A427- -0-20- NT	6,5W	2700K	30°	700mA	610Lm	89%
	A427- -0-21- NT	6,5W	3000K	30°	700mA	640Lm	89%
	A427- -0-22- NT	6,5W	4000K	30°	700mA	655Lm	89%
	A427- -0-30- NT	6,5W	2700K	56°	700mA	610Lm	86%
	A427- -0-31- NT	6,5W	3000K	56°	700mA	640Lm	86%
	A427- -0-32- NT	6,5W	4000K	56°	700mA	655Lm	86%

IP20 | CRI>90 | L80B10 >60.000h



CORD LENGTH - L

0	2 m
2	5 m

Other length please consult

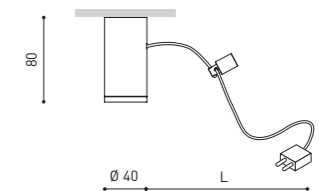

OPTIONAL ACCESSORIES

TOP Beam Mixer Diffuser* 0805-01-00



NOT SOLD SEPARATELY

TOP Anti-glare Louver* 0807-00-00 | NT |



NOT SOLD SEPARATELY

Cord Accessory 0223-00-00- | N |

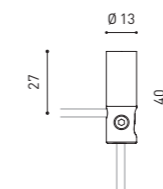

Cord Accessory One Plane 0224-00-00- | N |

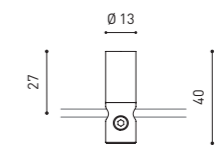

TOP Fancy Shape
Application example 2 Lamps

TOP Fancy Shape
Application example 4 Lamps

TOP Fancy Shape
Application example 10 Lamps

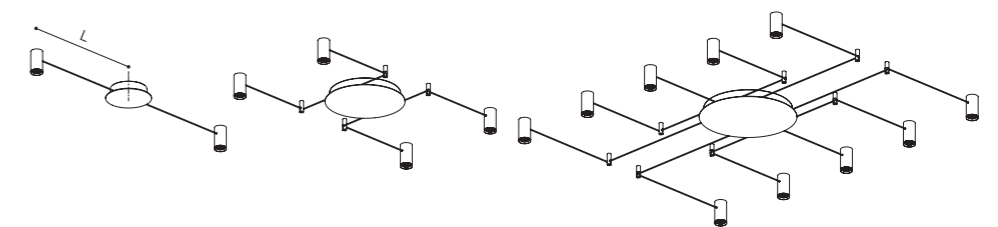

COLOUR | NT ■ | WT □ | N ■ | MATERIAL | AL | ABS+PC |

RAL » 120

* ACCESSORIES AFFECT THE LIGHTING PARAMETERS

» PLEASE CONSULT

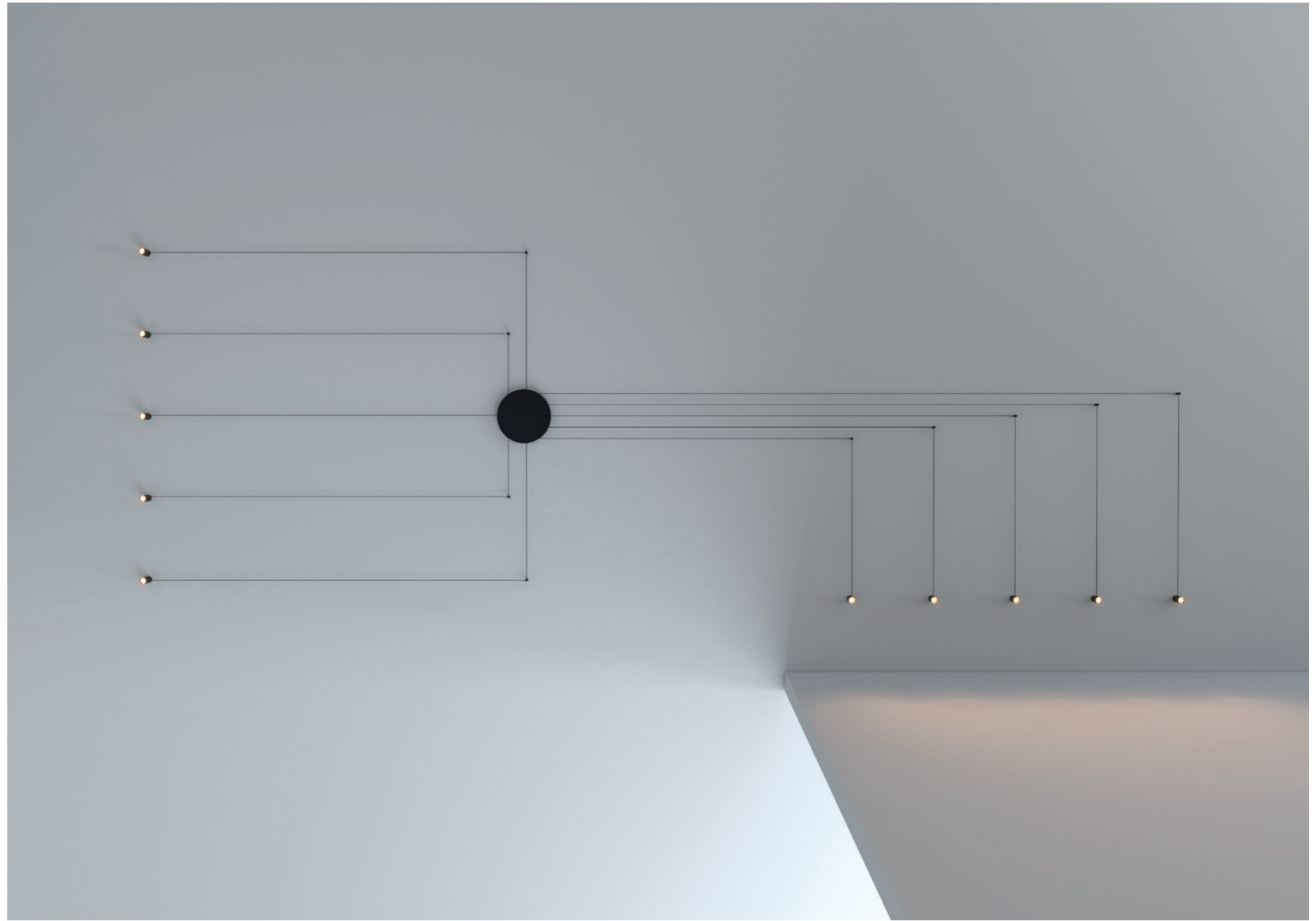



UP

Up es un pie de salón, una escultura racional y sobria que transmite armonía y serenidad visual. Su luz, proyectada verticalmente, baña el plano del techo y, como consecuencia, el ambiente se ilumina con una confortable luz indirecta.

Up is a floor lamp, a rational and sober sculpture that conveys visual harmony and serenity. Its light, projected vertically, bathes the ceiling plane and, as a consequence, the environment is illuminated with a comfortable indirect light.

Up est un lampadaire de salon, une sculpture rationnelle et sobre qui transmet harmonie et sérénité visuelle. Sa lumière, projetée verticalement, baigne le plafond et, par conséquent, la pièce est illuminée grâce à un éclairage indirect confortable.

Up è una lampada da terra, una scultura razionale e sobria che trasmette armonia e serenità visiva. La sua luce, proiettata verticalmente, irradia il piano del soffitto e, di conseguenza, l'ambiente viene illuminato con una confortevole luce indiretta.

Up ist eine Stehleuchte, eine rationale und schlichte Skulptur, die Harmonie und optische Ruhe vermittelt. Ihr vertikal projiziertes Licht scheint auf die Zimmerdecke und beleuchtet so die Umgebung mit einem angenehmen indirekten Licht.



reddot winner 2021
lighting design





		P	CCT	I	Flux	LOR
UP	A402-00-00- WT NT	31W	2700K	930mA	3850Lm	76%
	A402-00-01- WT NT	31W	3000K	930mA	4000Lm	76%

LED | CE | IP20 | CRI>90 | L80B10 >60.000h

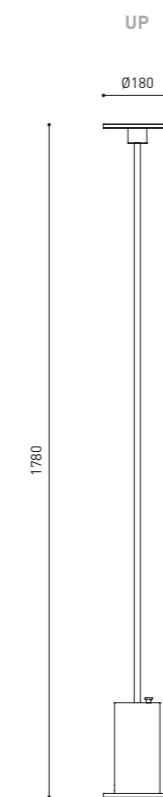

COLOUR | WT | NT |

MATERIAL | AL | FE |

RAL » 120





Vicarbe showroom, Valencia (Spain) | Photography: Mayte Plera





La Salita, Valencia (Spain) | Interior design: Mediterranean Nomad | Photography: Héctor Rubio - Images Positive





MINIMAL TRACK

NOW SUSPENSION

Una finísima línea cruza el espacio en levitación: es el nuevo Minimal Track Suspension. El vanguardista y miniaturizado sistema de carril de Arkoslight, ahora flota en el aire con unos tensores casi invisibles.

A very fine line crosses the space in levitation: it is the new Minimal Track Suspension. Arkoslight's state-of-the-art miniaturised rail system now floats in the air with almost invisible turnbuckles.

Une ligne très fine traverse l'espace en lévitation : c'est le nouveau Minimal Track Suspension. Le système de rail d'Arkoslight, avant-gardiste et miniaturisé, flotte à présent dans l'air avec des tendeurs quasiment invisibles.

Una linea sottilissima attraversa lo spazio in levitazione: è la nuova Minimal Track Suspension. Il sistema a binari miniaturizzato all'avanguardia di Arkoslight ora galleggia a mezz'aria con tensori quasi invisibili.

Eine hauchdünne Linie durchquert den Raum im Schwebezustand: die neue Minimal Track Suspension. Das hochmoderne, miniaturisierte Schienensystem von Arkoslight schwebt jetzt mit fast unsichtbaren Spannelementen in der Luft.



reddot winner 2020
innovative product



reddot winner 2020
lighting design



Bronze Delta
ADI Awards 2020



24V SYSTEM

MINIMAL TRACK SUSPENSION



Architecture: Rubén Muedra - Estudio de Arquitectura | Photography: Adrián Mora Maroto

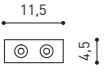
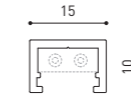
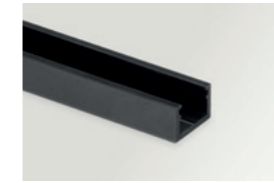

MINIMAL TRACK 24V Suspension

Profile 2m

A384-02-00- | N |

Profile 2m Initial feed kit

A400-02-10- | N |

Profile 2m Middle feed kit*

A400-02-20- | N |

* Unidirectional Middle Feed.



MINIMAL TRACK 24V Suspension Corner 90°

A400-00-03- | N |

Cable Length = 85mm.

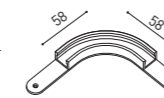

MINIMAL TRACK 24V Suspension

Rubber Cable n x 1m

A400-00-01- | N |

n = Total Length of System.

24V | Max. 4A | CE | III

MINIMAL TRACK 24V Suspension Straight Joiner

A400-00-02- | N |

MINIMAL TRACK 24V Suspension Kit

A400-02-04- | N |

MINIMAL TRACK 24V Suspension End Caps

A400-00-05- | N |

Two End Caps Included

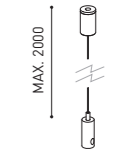
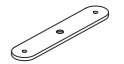

			P	V	D [A x B x C]
MINIMAL TRACK 24V Suspension	ON/OFF	A400-00-06- NT	40W	24V	280 x 30 x 36mm
	Power Supply Box	A400-00-07- NT	100W	24V	280 x 30 x 36mm
Included ON/OFF 24Vdc Power Supply					
MINIMAL TRACK 24V	ON/OFF	0434-01-37	60W	24V	180 x 52 x 30mm
	Remote Power Supply	0433-10-22	100W	24V	295 x 43 x 30mm

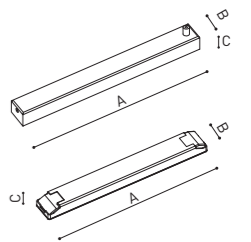

DROP VOLTAGE TABLE

POWER [W]	CABLE SECTION [mm²]	CABLE LENGTH (m)			
		<5	<10	<20	<30
40	0,75	30	30	30	30
	1,5	30	30	30	30
60	0,75	30	30	20	10
	1,5	30	30	30	20
100	0,75	20	10	X	X
	1,5	20	20	10	X

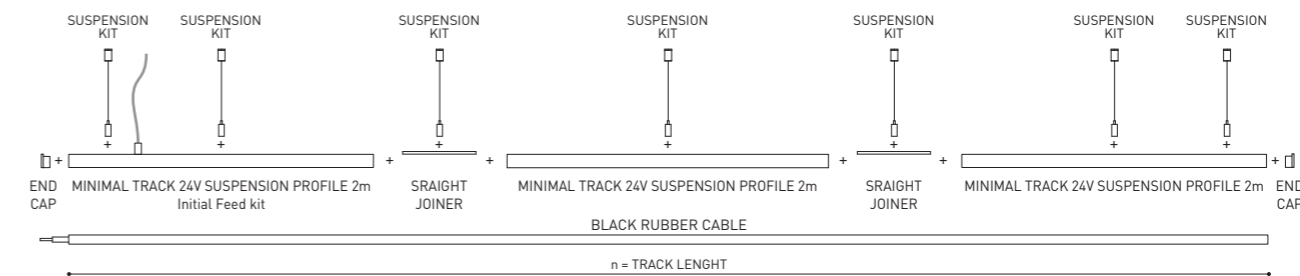
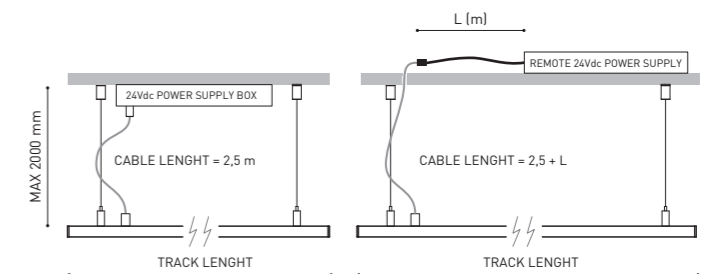

COLOUR | N ■ | NT ■ |

RAL ⓘ » 000

DIM OPTIONS PLEASE CONSULT





WALPOLE'S LEGACY

Horace Walpole's last years were lightened by the companionship of his neighbours Mary and Agnes Berry. After his death in 1797, Mary edited Walpole's complete works, including the first publication of some of his letters. His political memoirs and journals, a major source for future historians, were sealed at Walpole's request until 1810.

Strawberry Hill passed to Walpole's cousin's daughter, Anne Damer, and then to his great niece, Elizabeth Waldegrave, in whose family it remained until 1883. In 1842, the contents were dispersed in one of the most famous auctions of the century, and Walpole's name was added to the list of illustrious collectors, as he had always wished.

In the 20th century, the American scholar Wilmath Sheldon Lewis devoted his life to researching Walpole and his times and collecting his letters, books and objects. His collection is now in the Lewis Walpole Library, Yale University. Walpole's villa is being restored by the Strawberry Hill Trust and will open to the public this year.

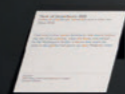

FIT 27

NEW 24V VERSION
FOR MINIMAL TRACK



		P	CCT	BEAM	I	Flux	LOR
FIT 27 24V	A399-00-10- WT NT G	4,5W	2700K	22°	400mA	440Lm	84%
	A399-00-11- WT NT G	4,5W	3000K	22°	400mA	475Lm	84%
	A399-00-20- WT NT G	4,5W	2700K	37°	400mA	440Lm	82%
	A399-00-21- WT NT G	4,5W	3000K	37°	400mA	475Lm	82%
	A399-00-30- WT NT G	4,5W	2700K	46°	400mA	440Lm	81%
	A399-00-31- WT NT G	4,5W	3000K	46°	400mA	475Lm	81%

LED | 24 V | CE | III | IP20 | CRI>90 | L80B10 >60.000h

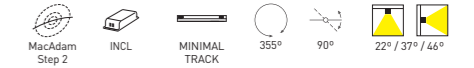

FIT 27 24V

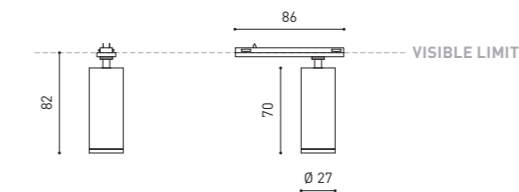

COLOUR | WT □ | NT ■ | G ■ | MATERIAL | AL | PC |

RAL ⓘ » 120

LINE MICRO

NEW 24V VERSION FOR MINIMAL TRACK



Photography: BISimages architectural photography



		P	CCT	I	Flux	LOR
LINE Micro 250 24V	A395-00-00- N	2W	2700K	400mA	330Lm	52%
	A395-00-01- N	2W	3000K	400mA	340Lm	52%
LINE Micro 500 24V	A395-10-00- N	5W	2700K	400mA	820Lm	52%
	A395-10-01- N	5W	3000K	400mA	840Lm	52%
LINE Micro 1000 24V	A395-20-00- N	9W	2700K	700mA	1430Lm	52%
	A395-20-01- N	9W	3000K	700mA	1500Lm	52%

LED | 24 V | CE | III | IP20 | CRI>90 | L80B10 >60.000h

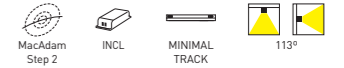

LINE MICRO 250 24V

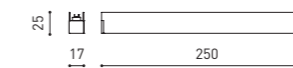

LINE MICRO 500 24V

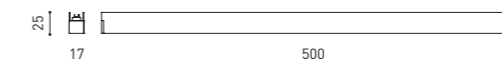

LINE MICRO 1000 24V

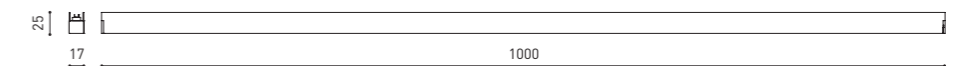

COLOUR | N ■ | MATERIAL | AL | PC

RAL ⓘ » 120

STEP

NEW SIZES S & XS

Dos nuevas tallas en miniatura para Step. La luminaria de función señalética, apta para exterior y zonas de tráfico peatonal.

Two new miniature sizes for Step. The light fitting with a signalling function, suitable for outdoors and pedestrian areas.

Deux nouvelles tailles en miniature pour Step. Le luminaire à fonction signalétique, convenant pour l'extérieur et aux zones de circulation piétonnes.

Due nuove misure in miniatura per Step. La lampada con funzione di segnalazione, adatta per esterni e in zone pedonali.

Zwei neue Miniaturgrößen für Step. Die Leuchte mit Signalfunktion, geeignet für den Außenbereich und für Fußgänger.



					P	CCT	I	Flux	LOR
STEP S	A392-00-00-	NX	W	N	1W	2700K	350mA	100Lm	10%
OUTDOOR	A392-00-01-	NX	W	N	1W	3000K	350mA	120Lm	10%
	A392-00-02-	NX	W	N	1W	4000K	350mA	130Lm	10%



DRIVER OPTIONS*	P	I	
0434-00-39	1W	350mA	1 to 12 Steps S

NO DIM | IP20*

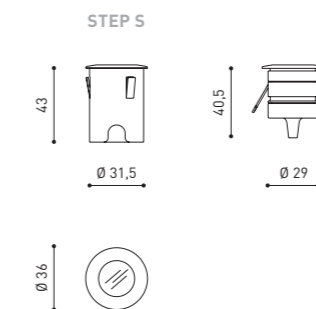

COLOUR | NX ■ | W □ | N ■ | MATERIAL | INOX AISI 340 | AL | PMMA

RAL ⓘ » 120

* HIGHER IP & DIM DRIVERS PLEASE CONSULT

» PLEASE CONSULT



Photography: Héctor Rubio - Images Positive

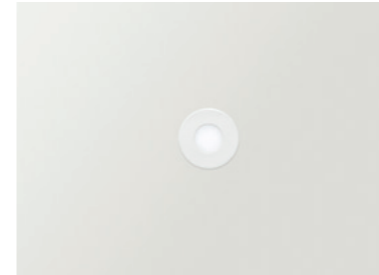

					P	CCT	I	Flux	LOR
STEP XS	A393-00-00-	NX	W	N	1W	2700K	350mA	100Lm	7%
OUTDOOR	A393-00-01-	NX	W	N	1W	3000K	350mA	120Lm	7%
	A393-00-02-	NX	W	N	1W	4000K	350mA	130Lm	7%

IP65 | **IK10** | CRI>90 | L80B10 >60.000h

DRIVER OPTIONS*	P	I	
0434-00-39	1W	350mA	1 to 12 Steps XS

| **IP20***

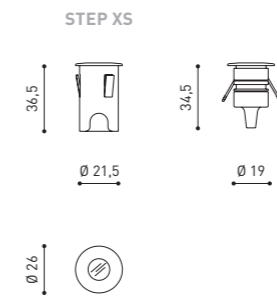

COLOUR | **NX** ■ | **W** □ | **N** ■ | MATERIAL | INOX AISI 340 | AL | PMMA |

RAL » 120

* HIGHER IP & DIM DRIVERS PLEASE CONSULT

» PLEASE CONSULT

WIRE TRIMLESS

ACCESSORIES

Los *Wire Trimless Accessories* reducen el peso visual de la instalación y generan una estética extremadamente minimalista. Los cables nacen desde el material en el techo como parte de la estructura. Este detalle genera una disposición mucho más pura y esencial, especialmente, en composiciones de varias unidades.

Wire Trimless Accessories reduce the visual weight of the installation and create an extremely minimalist aesthetic. The cables originate from the material in the ceiling as part of the structure. This detail creates a much purer and more essential arrangement, especially in multi-unit compositions.

Les *Wire Trimless Accessories* réduisent le poids visuel de l'installation et créent une esthétique extrêmement minimaliste. Les câbles sortent du matériau du plafond comme faisant partie de la structure. Ce détail offre une disposition beaucoup plus épurée et essentielle, en particulier dans des compositions de plusieurs unités.

I *Wire Trimless Accessories* riducono il peso visivo dell'installazione e creano un'estetica estremamente minimalista. I cavi provengono dal materiale del tetto come parte della struttura. Questo dettaglio crea una disposizione molto più pura ed essenziale, soprattutto nelle composizioni multi-unità.

Die *Wire Trimless Accessories* reduzieren das optische Gewicht der Installation und schaffen eine extrem minimalistische Ästhetik. Die Kabel entspringen als Teil der Struktur aus dem Material an der Decke. Dieses Detail schafft eine viel reinere und wesentlichere Aufteilung, besonders in Verbindung mit mehreren Einheiten.

WITH ACCESSORY

WITHOUT ACCESSORY



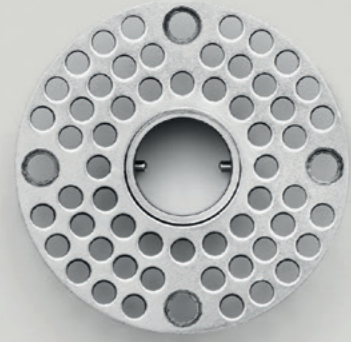

- (A) Mains Trimless
- (B) Mains Thick Trimless
- (C) Coaxial Trimless
- (D) Unipolar Trimless
- (E) Steel Cable Trimless
- (F) Steel Cable Regulator Trimless

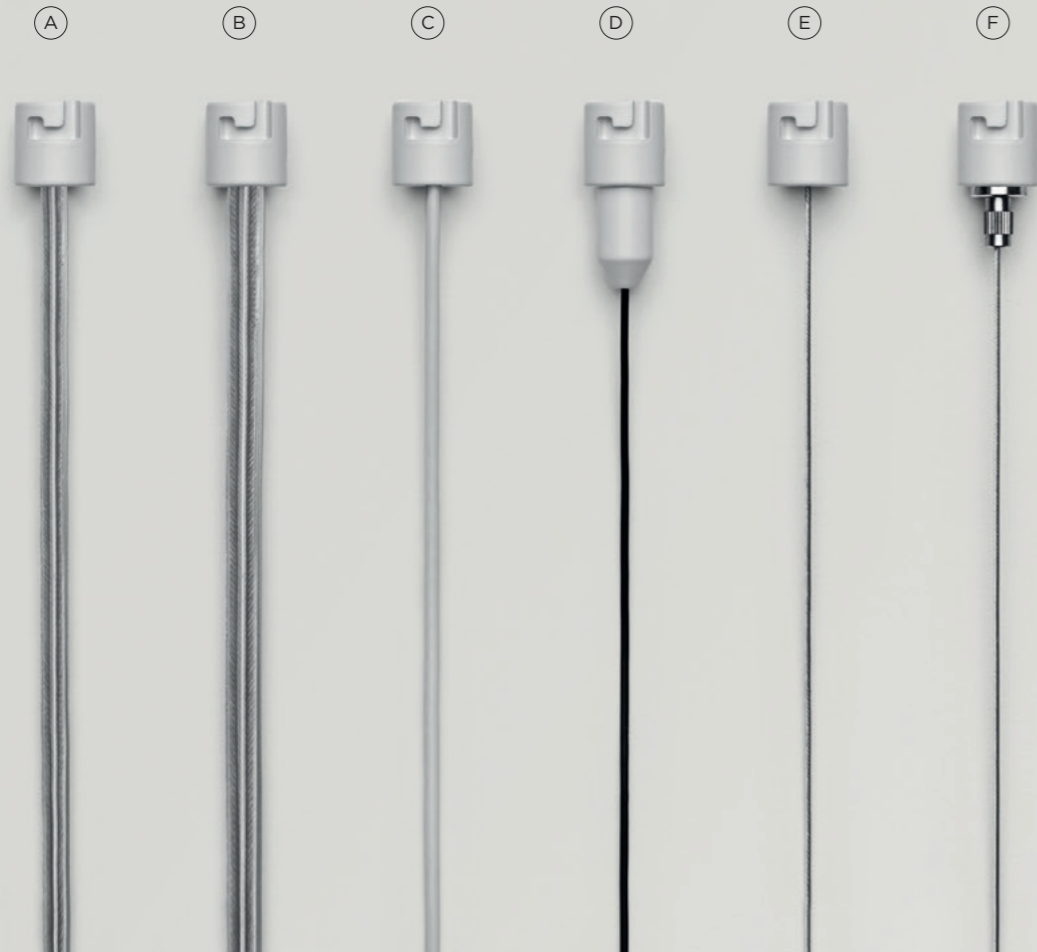

AVAILABLE FOR:



SALT



SCOPE



SALT MINI



TRACK 48V SUSPENSION



BLACK FOSTER SUSPENSION



HOLLY

SPIN

STICK

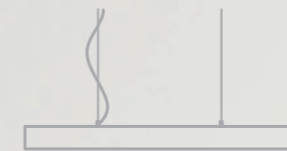

FIFTY SUSPENSION

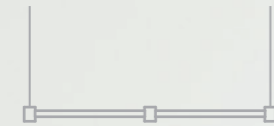

ART



DRUM SUSPENSION



MINIMAL TRACK



BRIGIT



SLIMGOT

STICK

Stick es una luminaria, concebida para iluminación de acento, que subraya la verticalidad del espacio donde se aplica. La liviana flotabilidad de una pieza de estética tan ligera es uno de sus mayores atractivos. Aplicaciones de suspensión, Track 48V, Minimal Track y Fancy Shape.

Stick is a light fitting, designed for accent lighting, which underlines the verticality of the space where it is applied. The light buoyancy of such a light aesthetic piece is one of its greatest attractions. Suspension applications, Track 48V, Minimal Track and Fancy Shape.

Stick est un luminaire conçu pour un éclairage ciblé, qui souligne la verticalité de l'espace où il est installé. La légère flottabilité d'une pièce à l'esthétique si délicate est l'un de ses plus grands atouts. Applications en suspension, Track 48V, Minimal Track et Fancy Shape.

Stick è una lampada concepita per l'illuminazione d'accento, che sottolinea la verticalità dello spazio in cui viene applicata. La leggera galleggiabilità di un oggetto di design così leggero è una delle sue maggiori attrazioni. Applicazioni a sospensione, Track 48V, Minimal Track e Fancy Shape.

Stick ist eine Leuchte, die für die Akzentbeleuchtung entworfen wurde und die Vertikalität des Raumes unterstreicht, in dem sie eingesetzt wird. Die leichte Beschwingtheit einer solch leichten, ästhetischen Leuchte ist einer ihrer größten Reize. Anwendung für Pendelabhängung, Track 48V, Minimal Track und Fancy Shape.





		P	CCT	Beam	I	Flux	LOR
STICK	A40-○-⊙-⊙-10- WT NT MG	5,6W	2700K	22°	500mA	530Lm	84%
	A40-○-⊙-⊙-11- WT NT MG	5,6W	3000K	22°	500mA	600Lm	84%
	A40-○-⊙-⊙-20- WT NT MG	5,6W	2700K	37°	500mA	530Lm	82%
	A40-○-⊙-⊙-21- WT NT MG	5,6W	3000K	37°	500mA	600Lm	82%
	A40-○-⊙-⊙-30- WT NT MG	5,6W	2700K	46°	500mA	530Lm	81%
	A40-○-⊙-⊙-31- WT NT MG	5,6W	3000K	46°	500mA	600Lm	81%

LED | 220 V- | 240 | CE | IP20 | CRI>90 | L80B10 >60.000h | MacAdam Step 2 | OPTIONS* | INCL | Ø50 | 22° / 37° / 46°

○	STICK LENGTH	⊙	CORD LENGTH-L	⊙	OPTIONS*
4	STICK 22 220 mm	0	2 m	1	No DIM
5	STICK 44 440 mm	2	5 m	2	DIM DALI
6	STICK 66 660 mm				

OPTIONAL ACCESSORY

Cord Accessory

0223-00-00- | N |

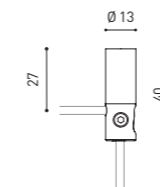

WIRE TRIMLESS ACCESSORY

COAXIAL TRIMLESS

A023-00-03- | W | N |

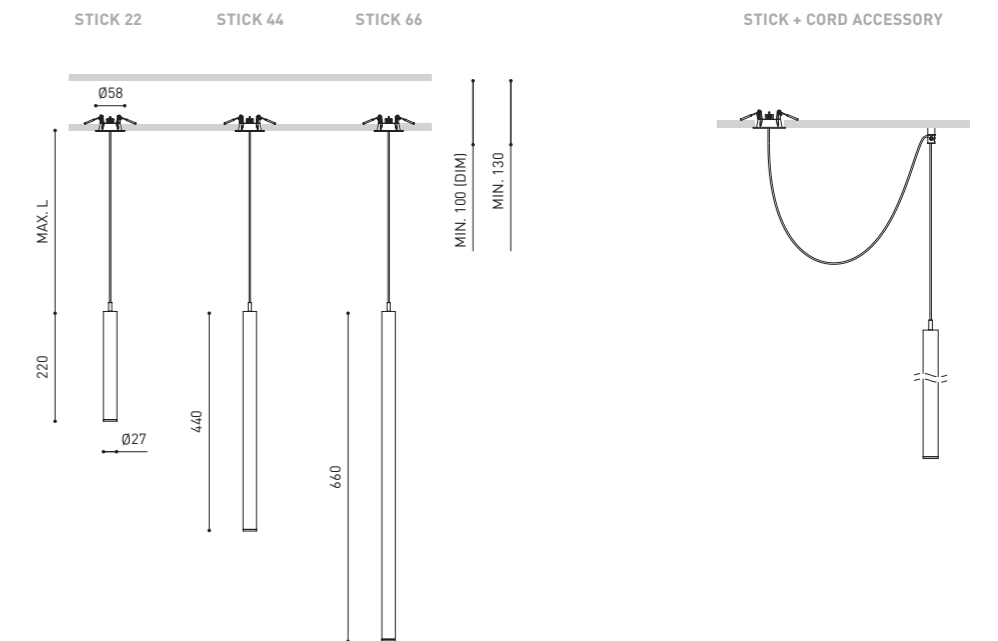
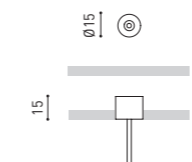

COLOUR | WT □ | NT ■ | MG ■ | N ■ | MATERIAL | AL | ABS+PC | RAL ⓘ » 120

» PLEASE CONSULT



Building Company: BFM Aedificatoria | Photography: Germán Cabo - Fotografía de arquitectura



				P	CCT	Beam	I	Flux	LOR	
STICK 22 24V	A410-01-10-	WT	NT	MG	4,5W	2700K	22°	400mA	440Lm	84%
	A410-01-11-	WT	NT	MG	4,5W	3000K	22°	400mA	475Lm	84%
	A410-01-20-	WT	NT	MG	4,5W	2700K	37°	400mA	440Lm	82%
	A410-01-21-	WT	NT	MG	4,5W	3000K	37°	400mA	475Lm	82%
	A410-01-30-	WT	NT	MG	4,5W	2700K	46°	400mA	440Lm	81%
	A410-01-31-	WT	NT	MG	4,5W	3000K	46°	400mA	475Lm	81%

LED | 24 V | CE | III | IP20 | CRI>90 | L80B10 >60.000h

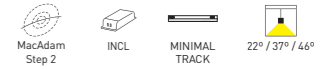

OPTIONAL ACCESSORY

Cord Accessory

0223-00-00- | N |

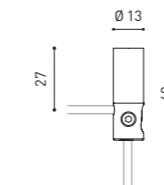

STICK 22 24V

STICK 22 24V + CORD ACCESSORY

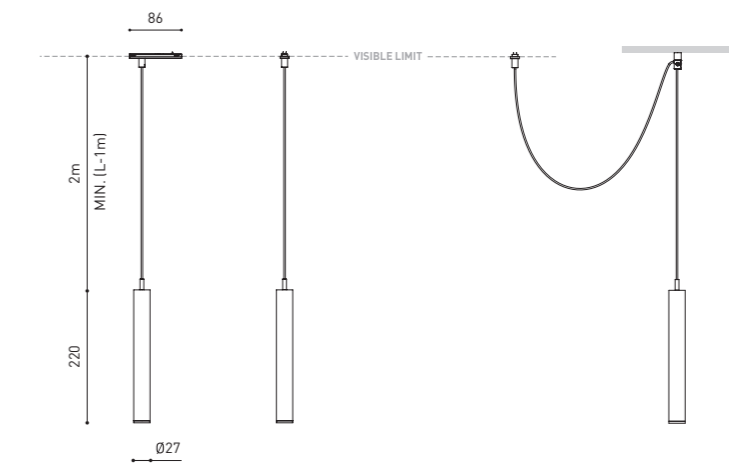

COLOUR | WT □ | NT ■ | MG ■ | N ■

MATERIAL | AL | ABS+PC

RAL ⓘ » 120

» PLEASE CONSULT



Building Company: BFM Aedificatoria | Photography: Germán Cabo - Fotografía de arquitectura



STICK 48V		P	CCT	Beam	I	Flux	LOR
A40-○-○-○-10-	WT NT MG WTW NTW MGW	5,6W	2700K	22°	500mA	530Lm	84%
A40-○-○-○-11-	WT NT MG WTW NTW MGW	5,6W	3000K	22°	500mA	600Lm	84%
A40-○-○-○-20-	WT NT MG WTW NTW MGW	5,6W	2700K	37°	500mA	530Lm	82%
A40-○-○-○-21-	WT NT MG WTW NTW MGW	5,6W	3000K	37°	500mA	600Lm	82%
A40-○-○-○-30-	WT NT MG WTW NTW MGW	5,6W	2700K	46°	500mA	530Lm	81%
A40-○-○-○-31-	WT NT MG WTW NTW MGW	5,6W	3000K	46°	500mA	600Lm	81%

LED | 48V | CE | IP20 | CRI>90 | L80B10 > 60.000h

MacAdam Step 2 | OPTIONS* | INCL | TRACK 48V | 22° / 37° / 46°

○	STICK LENGTH	⊖	CORD LENGTH-L	⊖	OPTIONS*
7	STICK 22 220 mm	0	2 m	1	No DIM
8	STICK 44 440 mm	2	5 m	2	DIM DALI
9	STICK 66 660 mm				

OPTIONAL ACCESSORY

Cord Accessory

0223-00-00- | N |

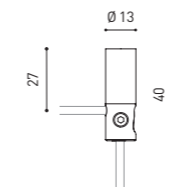

FINISHING	Lamp	Adaptor
WT	WT □ N ■	
NT	NT ■ N ■	
MG	MG ■ N ■	
WTW	WT □ W □	
NTW	NT ■ W □	
MGW	MG ■ W □	

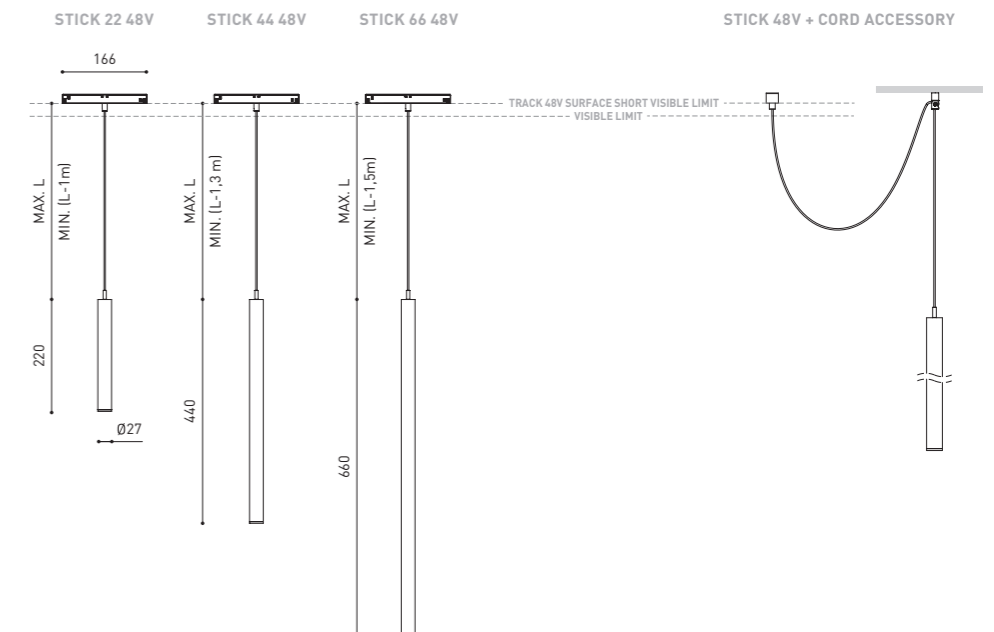

COLOUR | WT □ | NT ■ | MG ■ | N ■ | MATERIAL | AL | ABS+PC | RAL ⓘ » 120

» PLEASE CONSULT

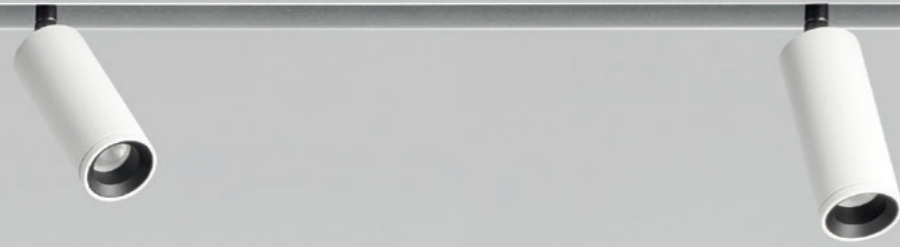

48V WHITE

El sistema de carril de bajo voltaje Track 48V se ofrece ahora en terminación de color blanco. Todos los productos se han desarrollado en versión específica para combinar con este nuevo acabado.

The Track 48V low voltage rail system is now offered in a white finish. All the products have been developed in a specific version to combine with this new finish.

Le système de rail à faible tension Track 48V est désormais proposé en blanc. Tous les produits ont été conçus en version spécifique pour être combinés avec cette nouvelle finition.

Il sistema di binari a bassa tensione Track 48V è ora disponibile in una finitura bianca. Tutti i prodotti sono stati sviluppati in una versione specifica da abbinare a questa nuova finitura.

Das Niederspannungsschienensystem Track 48V ist jetzt in weißer Ausführung erhältlich. Alle Produkte wurden in einer speziellen Version entwickelt, die zu dieser neuen Ausführung passt.



Track 48V White Colour CODE Generator Example

Reference from *The 2019 Collection*

A338 11 00 X

COLOUR OPTIONS
NT: Textured Black
WT: Textured White

FIT 48V CODE Generator Example

Reference from *The 2019 Collection*

A346 01 10 X

COLOUR OPTIONS
WT Lamp: Textured White | Adaptor: Black
NT Lamp: Textured Black | Adaptor: Black
G Lamp: Gold | Adaptor: Black
WTW Lamp: Textured White | Adaptor: White
NTW Lamp: Textured Black | Adaptor: White
GW Lamp: Gold | Adaptor: White

FIT

NOW IN GOLD FINISHING

Fit está disponible en un nuevo acabado dorado. Su cuerpo cilíndrico en oro aporta mayor calidad percibida y transmite solidez, lujo, calidez y confort. Disponible en Fit 24V, Fit 48V, Fit Recessed y Black Foster Fit 35.

Fit is available in a new gold finish. Its cylindrical gold body provides higher perceived quality and transmits solidity, luxury, warmth and comfort. Available in Fit 24V, Fit 48V, Fit Recessed and Black Foster Fit 35.

Fit est disponible dans une nouvelle finition dorée. Son corps cylindrique en or offre une sensation de plus haute qualité et transmet solidité, luxe, chaleur et confort. Disponible sur Fit 24V, Fit 48V, Fit Recessed et Black Foster Fit 35.

Fit è disponibile in una nuova finitura dorata. Il suo corpo cilindrico in oro offre la percezione di alta qualità e trasmette solidità, lusso, calore e comfort. Disponibile in Fit 24V, Fit 48V, Fit Recessed e Black Foster Fit 35.

Fit ist in einer neuen goldenen Ausführung erhältlich. Ihr zylindrischer Körper in Gold sorgt für mehr Qualität, die man spürt, und vermittelt ein Gefühl von Widerstandsfähigkeit, Luxus, Wärme und Komfort. Erhältlich in den Ausführungen Fit 24V, Fit 48V, Fit Recessed und Black Foster Fit 35.

New Colour

CODE Generator Example - FIT 20 24V

Reference from *The 2019 Collection*

A386 00 10 X

COLOUR OPTIONS

WT: Textured White

NT: Textured Black

G: Gold



OTHER UPDATES & NOVELTIES



DIALux

Arkoslight es *Premium Partner* en DIALux para apoyar a los profesionales en los proyectos lumínicos.

Arkoslight is a *Premium Partner* in DIALux to support professionals in lighting projects.

Arkoslight est *Premium Partner* à DIALux pour soutenir les professionnels dans des projets d'éclairage.

Arkoslight è *Premium Partner* di DIALux per supportare i professionisti nei progetti di illuminazione.

Arkoslight ist *Premium-Partner* von DIALux, um die Experten bei Ihren Beleuchtungsprojekten zu unterstützen.

DIALux
PREMIUM PARTNER

Art & Spin 3 Surface

Art y Spin 3 Surface están ahora disponibles en versión con base de superficie para techos donde no se puede empotrar.

Art and Spin 3 Surface are now available in a version with a surface base for ceilings where it cannot be recessed.

Art et Spin 3 Surface sont désormais disponibles dans la version avec une base de surface pour les plafonds où il n'est pas possible d'encaster.

Art e Spin 3 Surface sono ora disponibili nella versione con base a superficie per soffitti dove non può essere incassata.

Art und Spin 3 Surface sind jetzt auch in einer Aufbauversion für Decken erhältlich, in denen ein Einbau nicht möglich ist.



REC Double Double

Ahora, Rec Double desvincula su emisión de luz superior e inferior con encendidos y sistemas de regulación independientes.

Now, Rec Double decouples its upper and lower light emission with independent lighting control and dimming systems.

Désormais, Rec Double dissocie son émission de lumière supérieure et inférieure avec des systèmes d'éclairage et de régulation indépendants.

Ora, Rec Double separa la sua emissione di luce superiore e inferiore con sistemi di accensione e regolazione indipendenti.

Rec Double entkoppelt nun seinen oberen und unteren Lichtaustritt mit unabhängigen Einschalt und Dimmsystemen.



Fifty Corner

Fifty Custom permite ahora ejecutar giros en esquinas a 90° para una mayor libertad compositiva de este sistema personalizable de perfilería.

Fifty Custom now allows you to make 90° corner turns for greater compositional freedom from this customizable grid system.

Fifty Custom permet à présent d'effectuer des rotations dans des angles à 90° pour une plus grande liberté dans la composition de ce système au profilé personnalisable.

Fifty Custom ora ti consente di effettuare curve di 90° per una maggiore libertà compositiva da questo sistema personalizzabile di profili.

Fifty Custom ermöglicht nun 90°-Eckumlenkungen für mehr gestalterische Freiheit bei diesem anpassbaren Profilsystem.



INDEX

FULL PRODUCT COLLECTION

Encuentre el volumen donde se halla la información de su producto.

Find the volume where your product information is located.

Retrouvez le catalogue où se trouvent les informations.

Trova il volume in cui si trovano le informazioni sul prodotto.

Finden Sie die Ausgabe, in dem sich Ihre Produktinformationen befinden.

NEWS 2021 · COLLECTION UPDATE

2021

NEWS 2020 · COLLECTION UPDATE

2020

THE 2019 COLLECTION

2019

CEILING RECESSED



BLACK FOSTER MICRO

2021



BLACK FOSTER

2019 · 2020 · 2021



SHOT LIGHT

2019 · 2020 · 2021



SWAP

2019 · 2020



POINTER

2019



LEX ECO

2019 · 2020



ALASKA TRIMLESS

2021



PUCK RECESSED

2019 · 2020



DUOMO

2019



OLYMPIA

2019



DEEP

2019 · 2020



DROP

2019 · 2020



STRAM

2019 · 2020



FOX

2019 · 2020



MIX

2019 · 2020



NEOX

2019



OFFICE

2019



MADISON

2019



QUAD

2019



FIFTY

2019



ESSENTIALS

2019



POP UP

2019



HIDDEN

2019



TWIST

2019



ORBITAL

2019



WELLIT

2020



HUBBLE

2019



SIX RECESSED

2019



FIT RECESSED

2019 · 2021



PLUS RECESSED

2019

TRACKLIGHTS

MINIMAL TRACK

					
ALASKA 24V 2020	SIX XS 24V 2020	PLUS MICRO 24V 2020	IO MICRO 24V 2020	LINE MICRO 24V 2021	TOP MICRO 24V 2020
					
FIT 24V 2020 · 2021	STICK 22 24V 2021				



TRACK 48V

					
SIX 48V 2019 · 2020 · 2021	FIT 48V 2019 · 2020 · 2021	PLUS 48V 2019 · 2020 · 2021	IO 48V 2019 · 2020 · 2021	ZEN TUBE 48V 2019 · 2020 · 2021	TOP 48V 2019 · 2020 · 2021
					
LINE 48V 2019 · 2020 · 2021	STICK 48V 2021	HOLLY 48V 2019 · 2020 · 2021	SPIN 48V 2019 · 2020 · 2021		

TRACK 1L

		
IO 2019	PLUS MINI 1L 2019	FIT 65 1L 2020

TRACK 3L

					
SIX 2019	FIT 2019	PLUS 2019	ZEN 2019	ZEN TUBE 2019	THOR 2020 · 2021



SURFACE

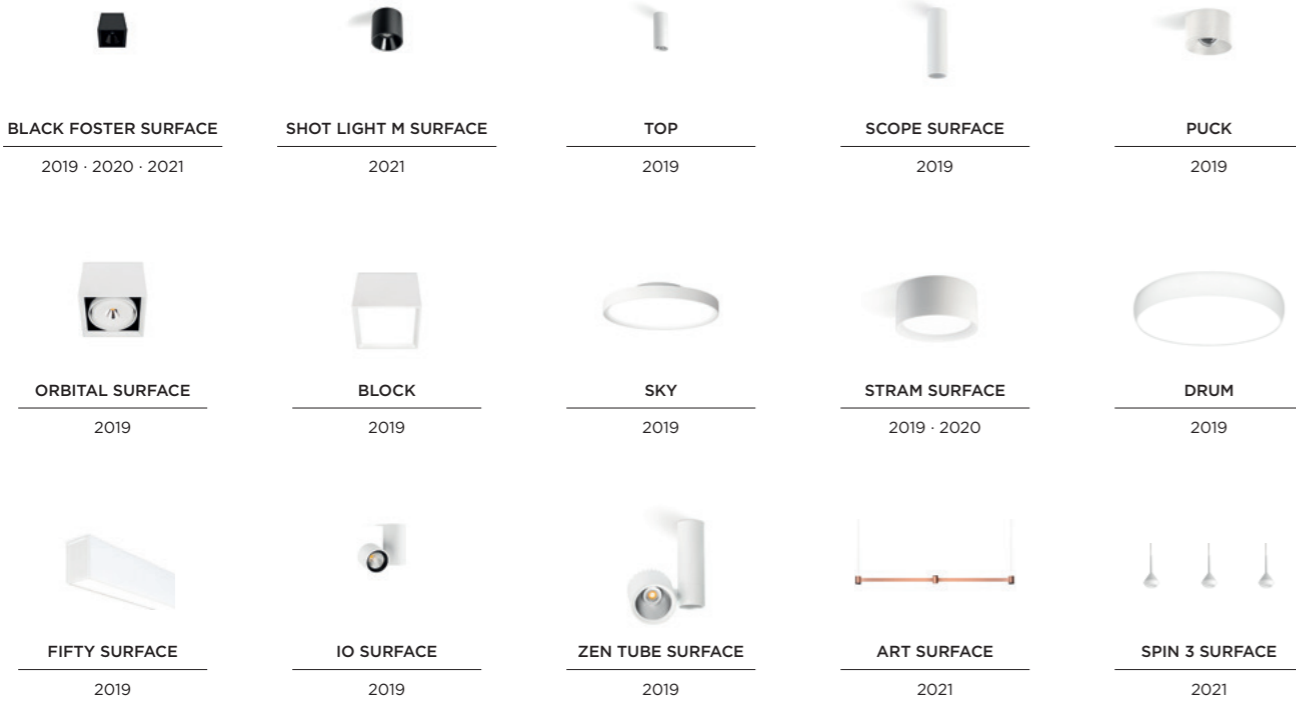

SUSPENSION



CUSTOM SYSTEMS

FANCY SHAPE



OTHER CUSTOM SYSTEMS





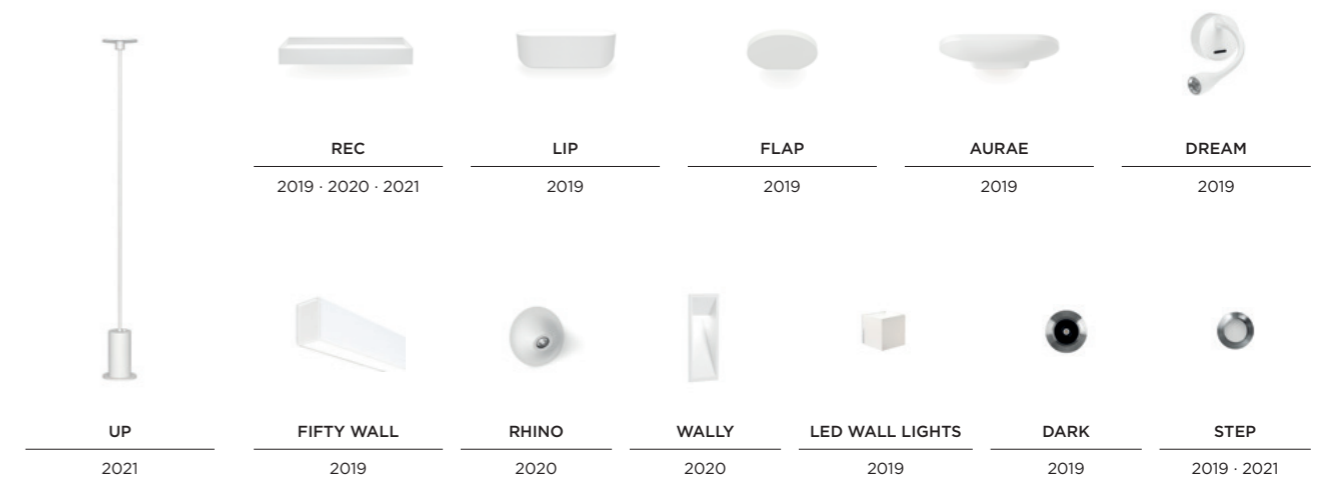











WALL & FLOOR



LARK & ACCESSORIES



Colours

	B White		N Matt black		WTMG Textured white - Metallized Gold
	WT Textured white		BG Brushed Gold		WMG White - Metallized Gold
	W Matt white		BC Brushed Copper		NMG Matt black - Metallized Gold
	WN White - Black		NX Stainless steel		NTMG Textured black - Metallized Gold
	NT Textured black		G Gold		R Red

ALASKA

- N = Colour in the mass looks alike RAL 9005
- N = Anodised, bath colour, looks alike RAL 9005
- N = RAL 9005
- BG = RAL not available. Electrolytic bath

ART

- WT = RAL 9016
- NT = RAL 9005
- BC = RAL not available.
Paint of metallic nanoparticles
- BG = RAL not available.
Paint of metallic nanoparticles

BLACK FOSTER

- N = RAL 9005
- NMG = RAL not available. Metallic finish
- NT = RAL 9005
- NTMG = RAL not available. Metallic finish
- WMG = RAL not available. Metallic finish
- WN = Colour in the mass looks alike RAL 9016 & RAL 9005
- WT = RAL 9016
- WTMG = RAL not available. Metallic finish

FANCY SHAPE

- WT = RAL 9016
- NT = RAL 9005

FIFTY

- WT = RAL 9016
- NT = RAL 9005

FIT

- WT = RAL 9016
- NT = RAL 9005
- G = RAL not available.
Paint of metallic nanoparticles

HOLLY

- WT = RAL 9016
- NT = RAL 9005
- MC = RAL not available. Electrolytic bath
- MG = RAL not available. Electrolytic bath

LINE MICRO 24V

- N = Anodised, bath colour, looks alike RAL 9005

MINIMAL TRACK

- N = RAL 9005
- NT = RAL 9005

REC

- WT = RAL 9016
- NT = RAL 9005

SHOT LIGHT

- N = Colour in the mass looks alike RAL 9005
- R = RAL 2004
- G = RAL 1036
- Z = RAL 9006
- WN = Colour in the mass looks alike RAL 9016 & Colour in the mass looks alike RAL 9005
- W = Colour in the mass looks alike RAL 9016
- NMG = RAL not available. Metallic finish
- WMG = RAL not available. Metallic finish

SPIN

- WT = RAL 9016
- NT = RAL 9005
- MC = RAL not available. Electrolytic bath
- MG = RAL not available. Electrolytic bath

STEP

- NX = RAL not available. Stainless steel.
- W = RAL 9016
- N = RAL 9005

STICK

- WT = RAL 9016
- NT = RAL 9005
- MG = RAL not available. Electrolytic bath

TOP

- WT = RAL 9016
- NT = RAL 9005

TRACK 48V

- WT = RAL 9016
- N = RAL 9005

UP

- WT = RAL 9016
- NT = RAL 9005

Los valores de iluminación indicados para cada código de referencia corresponden a los resultados obtenidos en los ensayos realizados sobre el primer color mencionado de la lista.

The lighting values indicated for each ref. code correspond to the results obtained from the tests carried out on the first mentioned colour of the list.

Les valeurs d'éclairage indiquées pour chaque code de référence correspondent aux résultats obtenus lors des essais réalisés sur la première couleur indiquée dans la liste.

I valori di illuminazione indicati per ogni codice di riferimento corrispondono ai risultati ottenuti nelle prove realizzate sul primo colore menzionato nell'elenco.

Die für jeden Artikelcode angegebenen Beleuchtungswerte entsprechen den Ergebnissen, die anhand der ersten in der Aufstellung enthaltenen Farbe ermittelt wurden.

ARKOSLIGHT®

Calle N · Pol. Ind. EL OLIVERAL
46394 Ribarroja del Turia · Valencia (Spain)
Tel. +34 961 667 207 · Fax +34 961 667 054
info@arkoslight.com · www.arkoslight.com
France: +33 182 885 200 · Italia: +39 02 9475 0007
Deutschland: +49 22 182 829 313



