

ITA  
ENG  
FRA

N° 41

Ola / Art / Ross / Flo / Kobo 2022  
Pik / Tok / **Flag** / Line / Still 2023  
Tag / Noa / Ago / Inc / Cnc  
**Rnc** / Tnc / **Pop** / Downlight  
**Kura** / **Dodo** / **Tape** / Koi  
Trend / Fix / Pin / Stile Next  
Pipeline / Stile / Airy / Nova  
Class / Green / Excell / Luce  
Nido / Tartaruga

AGGIORNAMENTO  
PREZZI AGOSTO 2022

PRICE LIST UPDATE  
AUGUST 2022

MISE À JOUR LISTE  
DES PRIX AOÛT 2022

CATA  
LOGO  
OPER  
ATIVO

Lights for everyday life. **LOMBARDO**



# INDEX

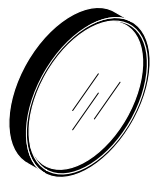

**ola**

p. 24

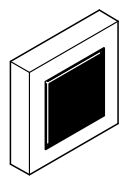

**art**

p. 32



**ross**

p. 42

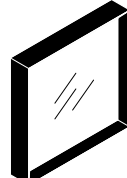

**flo**

p. 50

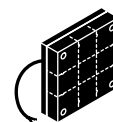

**kobo 110**

p. 66



**pik**

p. 78



**tok**

p. 90

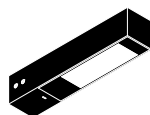

**flag**

p. 110

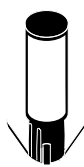

**line**

p. 128



**kit line post**

p. 138



**still**

p. 144



**tag**

p. 146



**kit tag**

p. 156



**noa**

p. 172



**ago**

p. 188



**ago top**

p. 200



**ago applique**

p. 204



**ago bollard**

p. 208



**inc**

p. 218



**cnc**

p. 224



**rnc**

p. 262

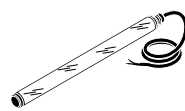

**tnc**

p. 272



**Pop**

p. 280

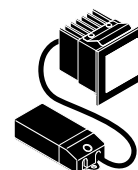

**downlight**

p. 294

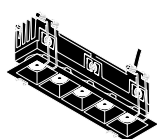

**Kura**

p. 298

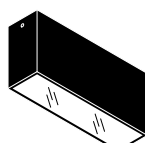

**Kura Top**

p. 306

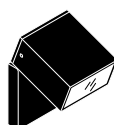

**Kura Reg**

p. 312

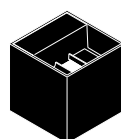

**Dodo**

p. 316

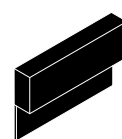

**Tape**

p. 326

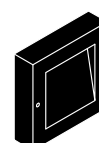

**koi**

p. 338

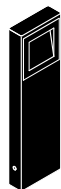

**koi post**

p. 344

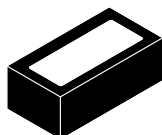

**trend**

p. 350

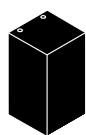

**trend 60**

p. 360



**trend 60 post**

p. 368

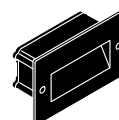

**fix**

p. 372



**pin**

p. 378

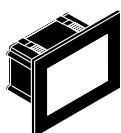

**stile next**

p. 388



**kit stile next post**

p. 408

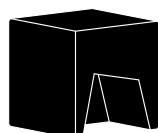

**cemento style**

p. 414



**pipeline**

p. 416

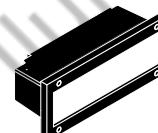

**stile**

p. 418



**airy**

p. 420



**nova / class**

p. 428



**green**

p. 434



**excell**

p. 436



**luce**

p. 437



**nido**

p. 440



**tartaruga**

p. 442

**Sensori** Motion sensor - Détecteur de présence p. 445

**Morsettiere e SPD** Terminal blocks - Borniers  
Surge protector devices - Dispositif anti surtension p. 448

**Ricerca alfanumerica per codice** A-Z search by code  
Recherche alpha-numérique par référence p. 454















**Rete commerciale** Sales network - Réseau commercial p. 480

**Note generali** General note - Notes générales p. 482



**Condizioni di garanzia** Terms of guarantee - Conditions de garantie p. 484

# INDICAZIONI PER LA CONSULTAZIONE











## Verniciatura *Painting - Peinture*

 Bianco RAL 9003 White RAL 9003 Blanc RAL 9003	 Bianco RAL 9010 White RAL 9010 Blanc RAL 9010	 Nero verniciato Black painted Noir peint	 Grigio High Tech RAL 9006 Grey High Tech RAL 9006 Gris High Tech RAL 9006	 Grigio antracite RAL 7021 Grey anthracite RAL 7021 Gris anthracite RAL 7021	 Dark Grey RAL 7021 Dark Grey RAL 7021 Gris Foncé RAL 7021
 Rame verniciato Copper Cuivre peint	 Grigio Antracite RAL 7021 - Oro Grey anthracite RAL 7021 - Gold Gris anthracite RAL 7021 - Gold	 Bianco - Gold White - Gold Blanc - Gold	 Grigio High Tech RAL 9006 - Giallo RAL 1016 Grey High Tech RAL 9006 - Yellow RAL 1016 Gris High Tech RAL 9006 - Jaune RAL 1016	 Bianco - Nero verniciato White - Black painted Blanc - Noir peint	 Bianco RAL 9010 - Rame White RAL 9010 - Copper Blanc RAL 9010 - Cuivre peint
 Bianco - Rame White - Copper Blanc - Cuivre	 Bianco - Silver White - Silver Blanc - Silver				

## Colore proprio del materiale *Colour of the material (moulded) - Appareils en polycarbonate teints dans la masse*

 Bianco da stampaggio White Blanc moulé	 Nero da stampaggio Black Noir moulé
--	--







## Effetti speciali *Special effects - Effets spéciaux*

 Inox Spazzolato Brushed grey Inox brossé	 Inox satinato Satin grey Inox satiné	 Inox Lucido Polished stainless steel Inox brillant	 Corten	 Cemento grigio Concrete, grey Ciment, gris
 Acciaio Inox Elettrolucidato Stainless steel electropolished Acier inoxydable électropoli	 Alluminio Anodizzato Verde Anodized Alluminium Green Aluminium anodisé Vert	 Alluminio Anodizzato Nero Anodized Alluminium Black Aluminium anodisé Noir	 Alluminio Anodizzato Marrone Anodized Alluminium Brown Aluminium anodisé Marron	 Alluminio Anodizzato Grigio Anodized Alluminium Grey Aluminium anodisé Gris

## Serigrafia *Serigraphy - Sérigraphie*

 Serigrafia Nera Black serigraphy Sérigraphie noir	 Serigrafia Corten Corten serigraphy Sérigraphie Corten	 Serigrafia Grigio High Tech Grey High Tech Serigraphy Sérigraphie Gris High Tech	 Neutro Neutral Neutre
---	---	---	--

## Materiale diffusore *Diffuser Material - Type de diffuseur*

DIFF.	DIFF.	DIFF.	DIFF.	DIFF.	DIFF.
					
POLICARBONATO Polycarbonate Polycarbonate	PMMA	VETRO SERIGRAFATO Serigraphed glass Verre sérigraphié	VETRO SATINATO Frosted glass Verre effet satiné	VETRO ACIDATO Etched glass Verre acide	VETRO TRASPARENTE Transparent glass Verre transparent



## Iconografia Iconography - Iconographie

<p> <b>Alimentatore integrato</b> Integrated driver Alimentation intégrée</p> <p> <b>Alimentatore incluso da remoto</b> Remote driver included Alimentation déportée incluse</p> <p> <b>Alimentatore escluso</b> Driver not included Alimentation non incluse</p>	<p> INCLUDED</p> <p>Rilevatore di presenza incluso Motion sensor included Détecteur inclus</p>	<p> NOT INC.</p> <p>Predisposto per rilevatore di presenza/crepuscolare Suitable for motion sensor/Day and night sensor Conforme pour détecteur de présence/ Crépusculaire</p>	<p> SA - Rete più emergenza 3h Maintained emergency 3h Fonctionnement continu 3h</p>	<p> Funzione corridoio Corridor function Fonction corridor</p>	<p> Accensioni separate Double switching Allumage séparé</p>	<p> Sensore crepuscolare Day night sensor Détecteur crépusculaire</p>
---	--	--	--	--	--	---

## KIT

Composto da più codici prodotto  
Consisting of more than one product code  
Composé de plusieurs codes produits



Versione HONEYCOMB  
HONEYCOMB version  
Version HONEYCOMB

## DALI

Versione a led con alimentatore integrato DALI  
Led versions with integral ballast DALI  
LED avec alimentation intégrée DALI

## PUSH

Versione a led con alimentatore integrato PUSH  
Led versions with integral ballast PUSH  
LED avec alimentation intégrée PUSH

## 1-10V

Versione a led con alimentatore integrato 1...10V  
Led versions with integral ballast 1...10V  
LED avec alimentation intégrée 1...10V

## Classe di isolamento

Class

- Class I
- Class II
- Class III

## Colore LED

colour of led - couleur led

### \* Led colour

- 4000K
- 3000K, Im -5%
- 2700K, Im -5%
- Blue

**Completa il codice** sostituendo al quadrato rosso la lettera o il numero corrispondente alla temperatura colore scelta.

**Complete the code** by replacing the red box with the letter or number corresponding to the selected colour temperature.

**Compléter le code** en remplaçant le carré rouge par la lettre ou le numéro correspondant à la sélection de température couleur.

### \* Optic

**Completa il codice** sostituendo al quadrato grigio la lettera corrispondente al modello di ottica scelta.

**Complete the code** by replacing the grey box with the letter corresponding to the selected optic model.

**Compléter le code** en remplaçant le carré gris par la lettre correspondante au modèle de lentille choisie.

## Direzione fascio di luce

Light Beam - Angle d'éclairage

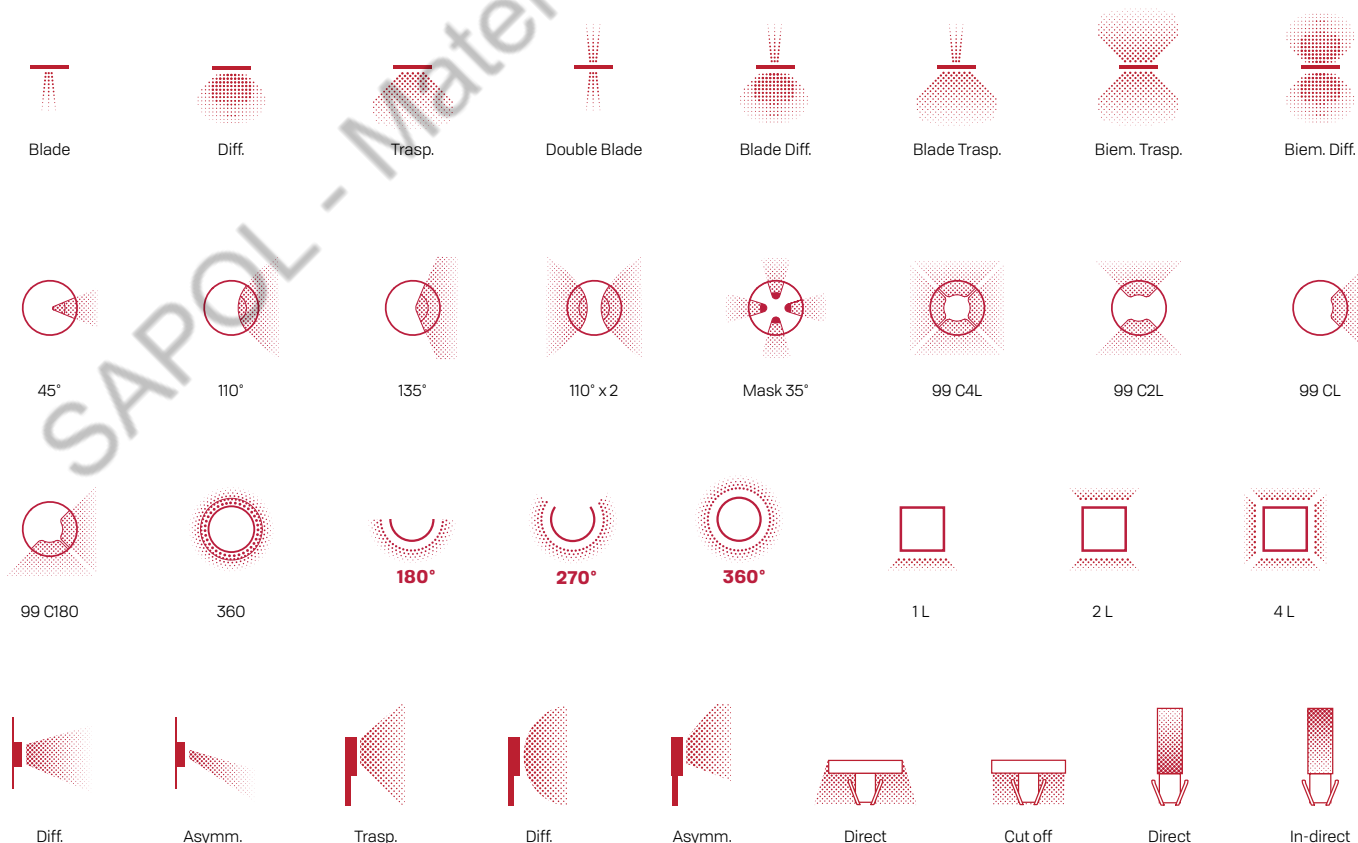

# INDICAZIONI PER LA CONSULTAZIONE

Guidance for consultation  
Mode de lecture

**Informazioni aggiuntive**  
Additional information  
Information complémentaires

**Materiali**  
Material  
Type de diffuseur

**Disegno dimensionale**  
Dimensional drawing  
Dessin dimensionnel

**Nome versione**  
Product name  
Appellation produit

**Simbologia tecnica**  
Technical symbols  
Symbologie technique

**Tipologie di lampade utilizzabili**  
Types of lamps that can be used  
Typologie des lampes utilisées

**Caratteristiche riferite ai prodotti della singola tabella**  
Features referring to the products of the single table  
Caracteristiques des produits de chaque tableau

**Iconografia delle info principali**  
Main info iconography  
Iconographie des principales informations

## Trend

**Trend 220**

**IP 66 IK 10 20J xx9 CE UK CR**

LED	W	LM	REAL LM	COL.	CODE * *	CODE * *	€	* OPTIC	* LED COLOUR
18	2450	1470 - 2250	⊕ ⊕ 220-240 V	[Color swatches]	LL490000	LL490004	174,00	S 8°	N 4000K
					LL490001	LL490005	174,00	M 10°	S 3000K, lm -5%
					LL490002	LL490006	174,00	L 30°	R 2700K, lm -5%
					LL490003	LL490007	174,00		
15	1900	1170 - 1875	⊕ ⊕ 220-240 V	[Color swatches]	LL4911	LL4917	148,00		
					LL491G	LL494G	148,00		
					LL491E	LL494E	148,00		
					LL491K	LL494K	148,00		
8	860	743	⊕ ⊕ 220-240 V	[Color swatches]	LL4931	LL4941	217,50		
					LL493G	LL494G	217,50		
					LL493E	LL494E	217,50		
					LL493K	LL494K	217,50		
<b>LAMP</b>		<b>ATT.</b>	<b>LAMP MAX</b>	<b>CFL</b>					
		E27	1x20	⊕	LB49121	LB49421	116,00		
					LB4912G	LB4942G	116,00		
					LB4912E	LB4942E	116,00		
					LB4912K	LB4942K	116,00		

Versione Monoemissione. Lampade dim. max: E27 128 mm Ø 48 mm.      Unidirectional version. Lamp max. dim.: E27 128 mm Ø 48 mm.      Version unidirectionnelle. Lampes dim. max: E27 128 mm Ø 48 mm.

**DIFF. POLIGLASS**      **DIFF. TRASP.**

**Trend Up&Down 220**

**IP 66 IK 10 20J xx9 CE UK CR**

LED	W	LM	REAL LM	COL.	CODE * *	CODE * *	€	* OPTIC	* LED COLOUR
24	3600	2160 - 3310	⊕ ⊕ 220-240 V	[Color swatches]	LL490008	LL490012	226,50	S 8°	N 4000K
					LL490009	LL490013	226,50	M 10°	S 3000K, lm -5%
					LL490010	LL490014	226,50	L 30°	R 2700K, lm -5%
					LL490011	LL490015	226,50		
15	2200	1260 - 2060	⊕ ⊕ 220-240 V	[Color swatches]	LL4921	LL4951	183,50		
					LL492G	LL495G	183,50		
					LL492E	LL495E	183,50		
					LL492K	LL495K	183,50		
11	1400	1078	⊕ ⊕ 220-240 V	[Color swatches]	LL4961	LL4961	299,50		
					LL496G	LL496G	299,50		
					LL496E	LL496E	299,50		
					LL496K	LL496K	299,50		
<b>LAMP</b>		<b>ATT.</b>	<b>LAMP MAX</b>	<b>CFL</b>					
		E27	1x20	⊕	LB49221	LB49521	116,00		
					LB4922G	LB4952G	116,00		
					LB4922E	LB4952E	116,00		
					LB4922K	LB4952K	116,00		

Versione Biemissione. Lampade dim. max: E27 128 mm Ø 48 mm.      Bidirectional version. Lamp max. dim.: E27 128 mm Ø 48 mm.      Version bidirectionnelle. Lampes dim. max: E27 128 mm Ø 48 mm.

**DIFF. POLIGLASS**      **DIFF. TRASP.**

**Finishing**

<ul style="list-style-type: none"> <li>□ Bianco RAL 9010</li> <li>□ Bianco RAL 9003</li> <li>□ Bianco RAL 9002</li> <li>□ Grigio High Tech RAL 9006</li> <li>□ Grey High Tech RAL 9008</li> <li>□ Grey High Tech RAL 9009</li> </ul>	<ul style="list-style-type: none"> <li>■ Grigio antracite RAL 7021</li> <li>■ Grey antracite RAL 7021</li> <li>■ Grigio antracite RAL 7021</li> <li>■ Corten</li> <li>■ Corten</li> <li>■ Corten</li> </ul>
--	---

**Alimentatore integrato**  
Integrated driver  
Alimentation intégrée

**\* Optic**

Completa il codice sostituendo al quadrato grigio la lettera corrispondente al modello di ottica scelta.

Complete the code by replacing the grey box with the letter corresponding to the selected optic model.

Compléter le code en remplaçant le carré gris par la lettre correspondante au modèle de lentille choisie.

**Per il medesimo prodotto i codici variano in funzione del colore**  
For the same product, the codes vary according to the colour  
Pour le même produit les références varient en fonction de la couleur



# Morsettiere e SPD

**Caratteristiche**  
Features  
Caractéristiques

**Disegno dimensionale**  
Dimensional drawing  
Dessin dimensionnel

## Morsettiere Terminal blocks - Borniers

**Nome accessorio**  
Accessory name  
Nom accessoire

### Morsettiere coassiale



Morsettiere coassiale a 3 poli, IP68, per cavo ø 7/12 mm.

Coaxial Terminal block  
Coaxial 3-pole terminal block,  
IP68, for cable diameter 7/12 mm.

Bornier coassiale  
Bornier coaxiale à 3 pôles, IP68  
pour câble diam. 7/12 mm

CODE	€
LB11293	16,00



### Morsettiere lineare a 3 vie



Morsettiere lineare a 3 vie a 3 poli, IP68, per cavo ø 7/13,5 mm.

3 way linear terminal block  
3-way 3-pole linear terminal block,  
IP68, for cable ø 7/13,5 mm.

Bornier linéaire 3 voies  
Bornier linéaire 3 voies à 3 pôles,  
IP68, pour câble diam. 7/13,5 mm

CODE	€
LB11294	25,50

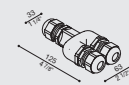

**Immagine rappresentativa**  
Image  
Image représentative

## Scaricatori di sovratensione Surge protector devices - Dispositif anti surtension

### Scaricatore di sovratensione SPD



Scaricatore di sovratensione di tipo II e tipo III.  
Tensione di funzionamento 120/320 VAC 50/60Hz.  
Tensione massima di scarica 10kV e corrente di scarica massima 10kAmp, grado di protezione IP67.  
Idoneo per installazioni a monte dell'apparecchio ed in serie rispetto al corpo illuminante.  
Tempi medi di intervento 8/20µs.  
Dotato di indicatore Led di funzionamento, a led spento il dispositivo deve essere sostituito.

Surge protector device type I and type III.  
Operating voltage 120/320 VAC 50/60Hz. Maximum voltage surge 10kV and maximum discharge current 10kAmp, protection grade IP67. Suitable for installation in series connection and before the lighting luminaire. Response time 8/20µs. Equipped with power indicator led, if the led is off the device must be replaced.

Dispositif anti surtension type II et III.  
Tension d'opération 120/320 VAC 50/60Hz. Tension de décharge maximal de 10kV et courant de décharge maximal de 10kAmp. Degré de protection IP67. Apprôprié pour installations en amont de l'alimentation et en série du dispositif d'éclairage. Temps de réponse 8/20µs. Équipé d'un indicateur de fonctionnement Led. Avec la Led éteinte, l'appareil doit être remplacé.

CODE	€
LB11298	25,00

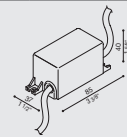

### Scaricatore di sovratensione SPD



Scaricatore di sovratensione di tipo II.  
Tensione di funzionamento 240 VAC 50/60Hz.  
Tensione massima di scarica 10kV e corrente di scarica massima 20kAmp, grado di protezione IP67.  
Idoneo per installazioni a monte dell'apparecchio ed in parallelo rispetto al corpo illuminante.  
Tempi medi di intervento <25ns.  
Dotato di indicatore Led di funzionamento, a led spento il dispositivo deve essere sostituito il componente non è idoneo ad installazione su impianti privi di messa a terra.

Surge protector device type II.  
Operating voltage 240 VAC 50/60Hz. Maximum voltage surge 10kV and maximum discharge current 20kAmp, protection grade IP67. Suitable for installation in parallel connection and before the lighting luminaire. Response time <25ns. Equipped with power indicator led, if the led is off the device must be replaced. The device is not suitable for installation without ground.

Dispositif anti surtension type II.  
Dispositif anti surtension type II.  
Tension d'opération 240 VAC 50/60Hz. Tension de décharge maximal de 10kV et courant de décharge maximal de 20kAmp. Degré de protection IP67. Apprôprié pour installations en amont de l'alimentation et en parallèle du dispositif d'éclairage. Temps de réponse <25ns. Équipé d'un indicateur de fonctionnement Led. Avec la led éteinte, l'appareil doit être remplacé. Non adapté à installation sans mise à la terre.

CODE	€
LB11299	30,00

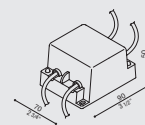

# POP



SAPOL - Material Eléctrico e Iluminación

NEW

p. 280



# KURA



p. 298



# KURA TOP

NEW

p. 306



# KURA REG

NEW

p. 312

# DODO

SAPOL - Mate

NEW

p. 316



# TAPE



NEW

p. 326

# FLAG 200



NEW

p. 110

# RNC SLIM

SAPOL - Material Eléctrico e Iluminação



# ACCESSORI TNC



NEW

p. 275



# AFFIDABILITÀ DINAMISMO SEMPLICITÀ

## ESPLORARE PER CONTINUARE A CRESCERE: UN PERCORSO CHE CI AFFASCINA DA SEMPRE.

Il progetto è uno dei momenti di maggior fascino nella vita di ognuno, e il suo compimento è qualcosa di unico, l'anello di congiunzione fra l'immaginazione e la realtà. All'interno di LOMBARDO si configura un laboratorio progettuale che apre nuove strade. Innovazione e design entrano a far parte del DNA aziendale, utilizzando ora risorse interne, ora contributi esterni, per sfruttare contaminazioni positive. A dare anima a questo lavoro è l'intuizione dei designers, capaci di integrare tecnologie della luce in forme e materiali inconsueti, ma sempre tecnicamente appropriati. Infine c'è uno stile, lo stile di un prodotto intelligente e allo stesso tempo easy, il cui valore è percepito direttamente, quasi istintivamente da chi lo "incontra".





LOMBARDO



50<sup>o</sup>  
1969-2019







**RELIABILITY**  
**DYNAMISM**  
**SIMPLICITY**

**ENG EXPLORE TO KEEP GROWING: A PATH THAT HAS ALWAYS**

**FASCINATED US.** The project is one of the most fascinating moments in everyone's life and its completion is something unique, the link between the imagination and the reality. Inside LOMBARDO the design laboratory opens new paths. Innovation and design become part of the company DNA, both using internal resources and external contributions, to exploit positive contaminations. What brings this work into life is the intuition of the designers, who able to integrate light technologies in unusual shapes and materials, but always technically appropriate. Finally, there is a style, an intelligent and easy product one, whose value is perceived directly and almost instinctively by those who "meet" it.

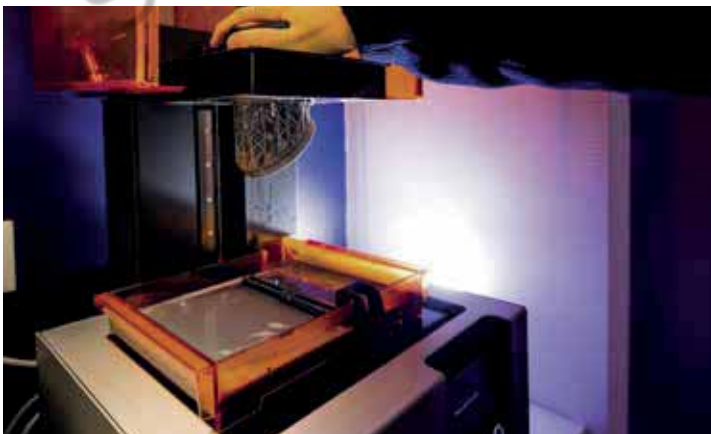







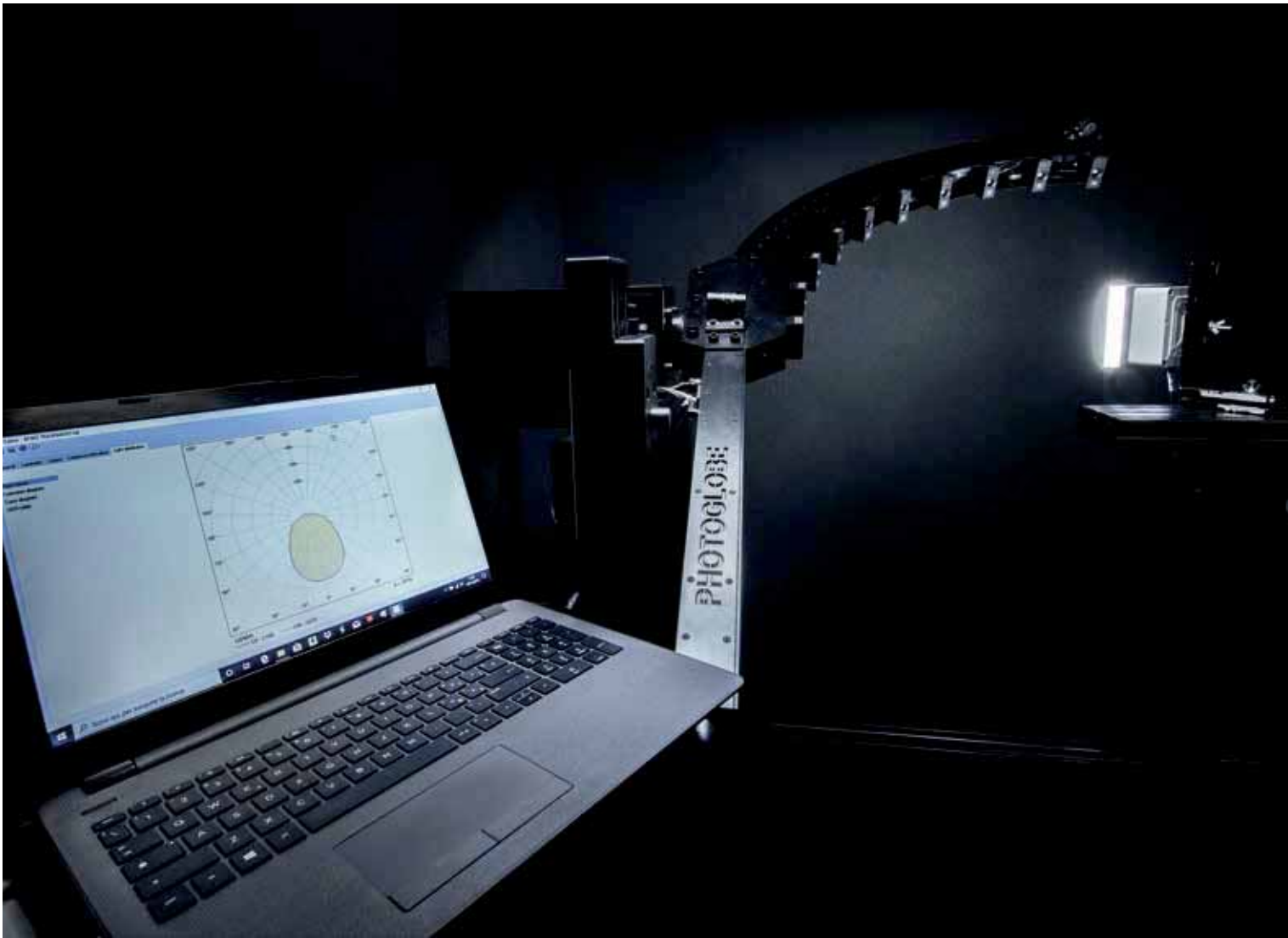



## FIABILITÉ DYNAMISME SIMPLICITÉ

**FRA EXPLORER POUR CONTINUER À GRANDIR: UN CHEMIN QUI NOUS A TOUJOURS FASCINÉS.** Projeter est l'un des moments les plus fascinants de la vie et son accomplissement est quelque chose d'unique, une bague de conjonction entre l'imagination et la réalité. LOMBARDO abrite un laboratoire de design qui ouvre de nouvelles rues. L'innovation et le design font partie de l'ADN de l'entreprise, grâce à ses ressources internes et à des contributions externes, pour exploiter les idées et les influences positives. Ce qui donne une âme au travail de Lombardo, c'est l'intuition des concepteurs, capables d'intégrer les technologies de la lumière dans des formes et des matériaux inhabituels, mais toujours techniquement appropriés. Enfin, il y a un style, celui d'un produit intelligent et en même temps easy, dont la valeur est perçue directement, presque instinctivement par ceux qui le "rencontrent".



# Ola

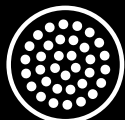

LED



indoor



outdoor





Adatto anche ad uso esterno.

Base in policarbonato, ottenuta da stampaggio ad iniezione proprio.

Diffusore in PMMA antiurto tripla stabilizzazione ai raggi UV, ad alto spessore con finitura PoliGLASS, ottenuto da stampaggio ad iniezione proprio.

Guarnizioni in silicone per il mantenimento del grado IP66.

Sistema di chiusura tramite grani, con cava esagonale ch.2.

Kit di fissaggio per il mantenimento del grado IP incluso.

LED a tensione di rete, dimmerabile a taglio di fase.

**LED 4000K (N), 3000K (3) o 2700K (2). Nessun rischio fotobiologico, RG0 gruppo di rischio esente (EN62471).**

**ENG** Also suitable for outdoor use.

Polycarbonate base, injection moulded in-house.

Very thick shockproof PMMA diffuser with triple UV stabilisation and PolyGLASS finish, injection moulded in-house.

Silicone gaskets to maintain IP66 rating.

Closing system by means of hex socket set screws size 2 mm.

Securing kit included to maintain IP rating.

LED AC direct, phase cut dimmable.

**LED 4000K (N), 3000K (3) or 2700K (2). No risk of photobiological damage, RG0 group (EN62471).**

**FRA** Également adapté à l'usage à l'extérieur.

Base en polycarbonate, s'obtient du moulage à injection propre.

Diffuseur en PMMA antichocs triple stabilisation aux rayons UV, très épais avec finition PoliGLASS, s'obtient du moulage à injection propre.

Joints en silicone pour maintenir le degré IP66.

Fermeture vis à six pans creux ch.2.

Kit de fixation pour le maintien du degré IP inclus.

LED AC direct 220-240V, dimmable coupure de phase.

**LED 4000K (N), 3000K (3) ou 2700K (2) (blanche chaud). Pas de risque photobiologique, RG0 groupe (EN62471).**

**Ola 330**



**Ola 330 Color**



**Outdoor  
e waterproof**



**Ola 500**



**Ola 500 Color**











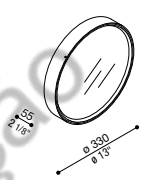

**Dimmerabile**  
Dimmable  
Dimmable

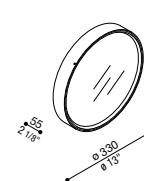

**Anni di garanzia  
sul circuito LED**  
Years warranty on LED circuit  
Ans de garantie sur la source LED







# Ola

<b>Ola 330</b>				DIFF. POLIGLASS		
IP 66 IK 08 5J xx7 CE UK CA						
<b>LED</b>	W	LM	REAL LM	COL.	CODE *	
	20	2500	1200	 AC DIRECT	 LL144000□	75,50
						N 4000K 3 3000K, lm -5% 2 2700K, lm -5%

<b>Ola 330 Color</b>				DIFF. POLIGLASS		
IP 66 IK 08 5J xx7 CE UK CA						
<b>LED</b>	W	LM	REAL LM	COL.	CODE *	
	20	2500	1200	 AC DIRECT	 LL14400G□ 91,50  LL14400E□ 91,50  LL14400K□ 91,50  LL14400U□ 91,50  LL14400Y□ 91,50  LL14400Z□ 91,50	N 4000K 3 3000K, lm -5% 2 2700K, lm -5%



## Finishing

	Bianco RAL 9010 White RAL 9010 Blanc RAL 9010		Bianco RAL 9010 - Rame White RAL 9010 - Copper Blanc RAL 9010 - Cuivre peint
	Grigio High Tech RAL 9006 Grey High Tech RAL 9006 Gris High Tech RAL 9006		Grigio High Tech RAL 9006 - Giallo RAL 1016 Grey High Tech RAL 9006 - Yellow RAL 1016 Gris High Tech RAL 9006 - Jaune RAL 1016
	Grigio antracite RAL 7021 Grey anthracite RAL 7021 Gris anthracite RAL 7021		Grigio Antracite RAL 7021 - Oro Grey anthracite RAL 7021 - Gold Gris anthracite RAL 7021 - Gold
	Corten Corten Corten		



<b>Ola 500</b>				<b>DIFF. POLIGLASS</b>											
<b>IP 66 IK 08 5J xx7</b>		<b>CE UK CA</b>													
<b>LED</b>	<b>W</b>	<b>LM</b>	<b>REAL LM</b>	<b>COL.</b>	<b>CODE *</b>	<b>€</b>	<b>* LED COLOUR</b>								
	42	5500	2139	<input type="checkbox"/> <input checked="" type="checkbox"/>	<b>AC DIRECT</b>	<input type="checkbox"/>	<b>LL144010</b>	<b>138,00</b>	<table border="0"> <tr><td><b>N</b></td><td>4000K</td></tr> <tr><td><b>3</b></td><td>3000K, lm -5%</td></tr> <tr><td><b>2</b></td><td>2700K, lm -5%</td></tr> </table>	<b>N</b>	4000K	<b>3</b>	3000K, lm -5%	<b>2</b>	2700K, lm -5%
<b>N</b>	4000K														
<b>3</b>	3000K, lm -5%														
<b>2</b>	2700K, lm -5%														

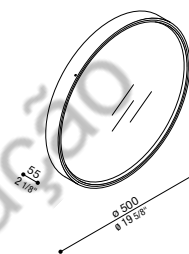

<b>Ola 500 Color</b>				<b>DIFF. POLIGLASS</b>									
<b>IP 66 IK 08 5J xx7</b>		<b>CE UK CA</b>											
<b>LED</b>	<b>W</b>	<b>LM</b>	<b>REAL LM</b>	<b>COL.</b>	<b>CODE *</b>	<b>€</b>	<b>* LED COLOUR</b>						
	42	5500	2139	<input type="checkbox"/> <input checked="" type="checkbox"/>	<b>AC DIRECT</b>		<table border="0"> <tr><td><b>N</b></td><td>4000K</td></tr> <tr><td><b>3</b></td><td>3000K, lm -5%</td></tr> <tr><td><b>2</b></td><td>2700K, lm -5%</td></tr> </table>	<b>N</b>	4000K	<b>3</b>	3000K, lm -5%	<b>2</b>	2700K, lm -5%
<b>N</b>	4000K												
<b>3</b>	3000K, lm -5%												
<b>2</b>	2700K, lm -5%												
				<input type="checkbox"/>	<b>LL14401G</b>	<b>161,00</b>	<b>N</b> 4000K						
				<input type="checkbox"/>	<b>LL14401E</b>	<b>161,00</b>	<b>3</b> 3000K, lm -5%						
				<input type="checkbox"/>	<b>LL14401K</b>	<b>161,00</b>	<b>2</b> 2700K, lm -5%						
				<input type="checkbox"/>	<b>LL14401U</b>	<b>161,00</b>							
				<input type="checkbox"/>	<b>LL14401Y</b>	<b>161,00</b>							
				<input type="checkbox"/>	<b>LL14401Z</b>	<b>161,00</b>							

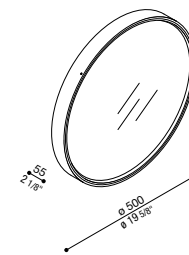

**\* Led colour**

- N** 4000K
- 3** 3000K, lm -5%
- 2** 2700K, lm -5%

**Completa il codice**  
sostituendo al quadrato rosso la lettera o il numero corrispondente alla temperatura colore scelta.

**Complete the code**  
by replacing the red box with the letter or number corresponding to the selected colour temperature.

**Compléter le code**  
en remplaçant le carré rouge par la lettre ou le numéro correspondant à la sélection de température couleur.

**✓ Alimentatore integrato**  
Integrated driver  
Alimentation intégrée



Colori disponibili.  
Available colours.  
Couleurs disponibles.







# Ola

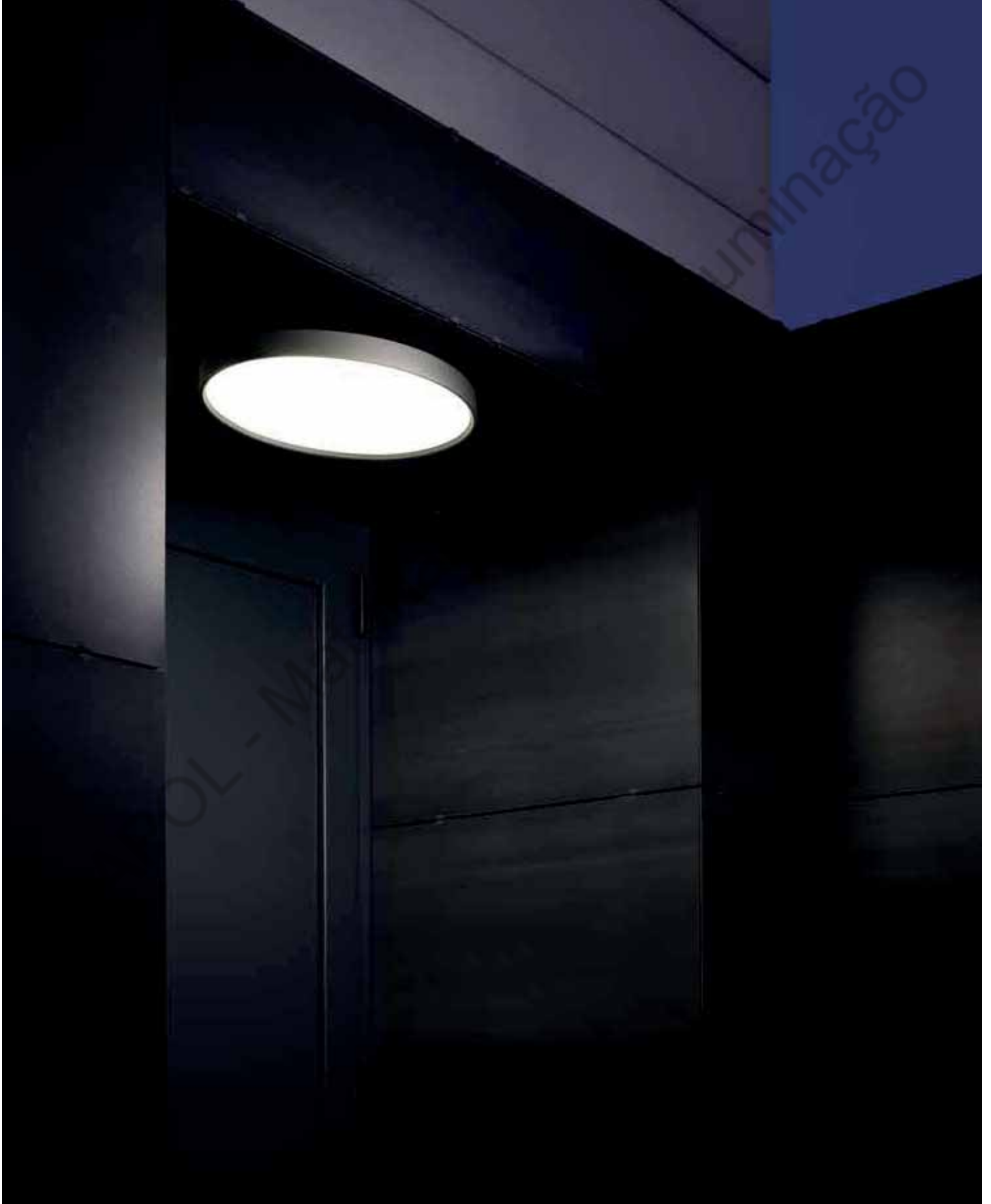



# Art

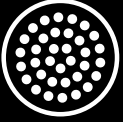

LED



indoor



outdoor



Adatto anche ad uso esterno.

Driver 220 - 240V integrato e moduli Led di ultima generazione. Base in policarbonato bianco, ottenuta da stampaggio ad iniezione proprio. Diffusore in Policarbonato tripla stabilizzazione ai raggi UV, ad alto spessore con finitura PoliGLASS, ottenuto da stampaggio ad iniezione proprio. Guarnizioni in silicone per il mantenimento del grado IP66.

Apertura e chiusura a scatto senza viti. Predisposto per viti di sicurezza.

Kit di fissaggio per il mantenimento del grado IP incluso.

**LED 4000K (N), 3000K (3) o 2700K (2). Alimentazione diretta 220-240V.**

**Nessun rischio fotobiologico, RGO gruppo di rischio esente (EN62471).**

**ENG** Also suitable for outdoor use. Integrated 220 - 240V ballast and latest generation Led modules. White polycarbonate base, injection moulded in-house. Very thick polycarbonate diffuser with triple UV stabilisation and PolyGLASS finish, injection moulded in-house. Silicone gaskets to maintain IP66 rating. Snaps open and closed without screws. Provision for safety screws. Securing kit included to maintain IP rating. **LED 4000K (N), 3000K (3) or 2700K (2). Integral ballast 220-240V. No risk of photobiological damage, RGO group (EN62471).**

**FRA** Également adapté à l'usage à l'extérieur. Driver 220 - 240V intégré et modules Led de dernière génération. Base en polycarbonate blanc, s'obtient du moulage à injection propre. Diffuseur en Polycarbonate triple stabilisation aux rayons UV, très épais avec finition PoliGLASS, s'obtient du moulage à injection propre. Joints en silicone pour maintenir le degré IP66. Ouverture et fermeture à déclic sans vis. Prévu pour vis de sécurité. Kit de fixation pour le maintien du degré IP inclus. **LED 4000K (N), 3000K (3) ou 2700K (2) (blanche chaud). Alimentation intégrée 220-240. Pas de risque photobiologique, RGO groupe (EN62471).**



**Outdoor  
e waterproof**



**Alimentazione diretta**

Direct power supply  
Alimentation directe



**Anni di garanzia  
sul circuito LED**

Years warranty on LED circuit  
Ans de garantie sur la source LED

**Art 100**

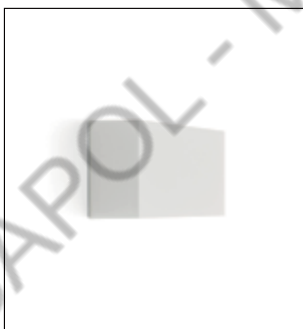

**Art 100 Top**



**Art 100 Code**



**Art 100 Crop**



**Art 250**



**Art 250 Mask**











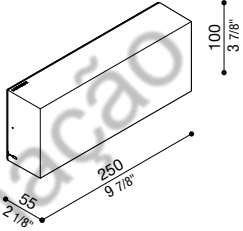

**Art 250 Code**











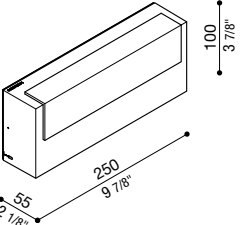



































**Art 250 Bamboo**



# Art

<b>Art 100</b>				<b>DIFF. POLIGLASS</b>				
<b>IP 66 IK 10 20J xx9</b>  								
LED	W	LM	REAL LM	COL.	CODE *		€ * LED COLOUR	
	10	1100	802	  220-240 V		<b>LL116000</b> 	<b>58,00</b>	 4000K  3000K, lm -5%  2700K, lm -5%

<b>Art 100 Top</b>				<b>DIFF. POLIGLASS</b>				
<b>IP 66 IK 10 20J xx9</b>  								
LED	W	LM	REAL LM	COL.	CODE *		€ * LED COLOUR	
	10	1100	484	  220-240 V		<b>LL116001</b> 	<b>67,50</b>	 4000K  3000K, lm -5%  2700K, lm -5%
					<b>LL116002</b> 	<b>67,50</b>		
					<b>LL116003</b> 	<b>67,50</b>		
					<b>LL116004</b> 	<b>67,50</b>		
					<b>LL116005</b> 	<b>67,50</b>		
	10	1100	484	  220-240 V  INCLUDED		<b>LS116001</b> 	<b>88,50</b>	
					<b>LS116002</b> 	<b>88,50</b>		
					<b>LS116003</b> 	<b>88,50</b>		
					<b>LS116004</b> 	<b>88,50</b>		
					<b>LS116005</b> 	<b>88,50</b>		
	10	1100	484	  220-240 V  		<b>LL116017</b> 	<b>88,50</b>	
					<b>LL116018</b> 	<b>88,50</b>		
					<b>LL116019</b> 	<b>88,50</b>		
					<b>LL116020</b> 	<b>88,50</b>		
					<b>LL116021</b> 	<b>88,50</b>		

Cover decorativa stampata in policarbonato, ottenuta da stampaggio ad iniezione proprio.

Decorative cover moulded in polycarbonate, injection moulded in-house.

Cover décorative moulée en polycarbonate, s'obtient du moulage à injection propre.



**Art 100 Code**

DIFF. POLIGLASS

IP 66 IK 10 20J xx9  $\text{CE}$   $\frac{\text{UK}}{\text{CA}}$

LED	W	LM	REAL LM	COL.	CODE *	€	* LED COLOUR
	10	1100	484	220-240 V	LN116001	101,50	4000K
					LN116002	101,50	3000K, Im -5%
					LN116003	101,50	2700K, Im -5%
					LN116004	101,50	
					LN116005	101,50	

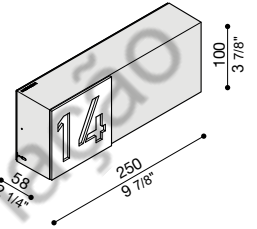

Versione speciale con cover decorativa stampata in PMMA. SPECIFICARE IN FASE D'ORDINE IL NUMERO DESIDERATO.

Special version with decorative cover moulded in PMMA. SPECIFY THE NUMBER REQUIRED WHEN ORDERING.

Version spéciale avec couverture décorative moulée en PMMA. SPECIFIER LE NUMÉRO DÉSIRÉ AU MOMENT DE LA COMMANDE.

**Art 100 Crop**

DIFF. POLIGLASS

IP 66 IK 10 20J xx9  $\text{CE}$   $\frac{\text{UK}}{\text{CA}}$

LED	W	LM	REAL LM	COL.	CODE *	€	* LED COLOUR
	10	1100	484	220-240 V	LL116006	92,50	4000K
					LL116007	92,50	3000K, Im -5%
					LL116008	92,50	2700K, Im -5%
					LL116009	92,50	
					LL116010	92,50	

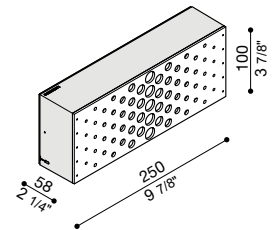

Versione speciale con cover decorativa stampata in policarbonato, ottenuta da stampaggio ad iniezione proprio.

Special version with decorative cover moulded in polycarbonate, injection moulded in-house.

Version spéciale avec couverture décorative moulée en polycarbonate, s'obtient du moulage à injection propre.

**Finishing**

Bianco da stampaggio White Blanc moulé	Grigio antracite RAL 7021 Grey anthracite RAL 7021 Gris anthracite RAL 7021
Nero da stampaggio Black Noir moulé	Corten Corten Corten
Grigio High Tech RAL 9006 Grey High Tech RAL 9006 Gris High Tech RAL 9006	

**\* Led colour**

- 4000K
- 3000K, Im -5%
- 2700K, Im -5%

**Completa il codice**  
sostituendo al quadrato rosso la lettera o il numero corrispondente alla temperatura colore scelta.

**Complete the code**  
by replacing the red box with the letter or number corresponding to the selected colour temperature.

**Compléter le code**  
en remplaçant le carré rouge par la lettre ou le numéro correspondant à la sélection de température couleur.

**Alimentatore integrato**  
Integrated driver  
Alimentation intégrée

# Art

## Art 250

DIFF.  
POLIGLASS

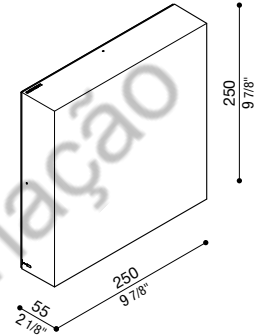

IP66 IK10 20J xx9 CE UK CA

LED	W	LM	REAL LM	COL.	CODE *	€	* LED COLOUR		
	20	2200	1656		220-240 V		LL116100	83,00	<ul style="list-style-type: none"> <li> 4000K</li> <li> 3000K, lm -5%</li> <li> 2700K, lm -5%</li> </ul>

## Art 250 Mask

DIFF.  
POLIGLASS

Disponibile versione DALI e dimmerabile.  
Available DALI and dimmable version.  
Version DALI et dimmable disponible.

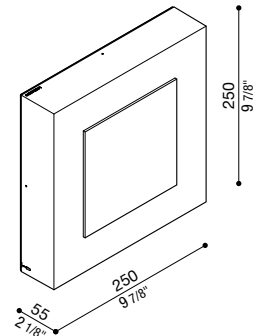

IP66 IK10 20J xx9 CE UK CA

LED	W	LM	REAL LM	COL.	CODE *	€	* LED COLOUR		
17	2040	1296			220-240 V		LL116101	102,50	<ul style="list-style-type: none"> <li> 4000K</li> <li> 3000K, lm -5%</li> <li> 2700K, lm -5%</li> </ul>
							LL116102	102,50	
							LL116103	102,50	
							LL116104	102,50	
							LL116105	102,50	
17	2040	1296			220-240 V		LS116101	121,50	
							LS116102	121,50	
							LS116103	121,50	
							LS116104	121,50	
							LS116105	121,50	
20	2040	1296			220-240 V		LL116106	237,50	
							LL116107	237,50	
							LL116108	237,50	
							LL116109	237,50	
							LL116110	237,50	
17	2040	1296			220-240 V		LL116117	121,50	
							LL116118	121,50	
							LL116119	121,50	
							LL116120	121,50	
							LL116121	121,50	

Cover decorativa stampata in policarbonato, ottenuta da stampaggio ad iniezione proprio.

Decorative cover moulded in polycarbonate, injection moulded in-house.

Cover décorative moulée en polycarbonate, s'obtient du moulage à injection propre.





**Art 250 Code**

DIFF. POLIGLASS

IP 66 IK 10 20J xx9 CE UK CRA

LED	W	LM	REAL LM	COL.	CODE *	€	* LED COLOUR
	17	2040			LN116101□	133,50	N 4000K
					LN116102□	133,50	3 3000K, lm -5%
					LN116103□	133,50	2 2700K, lm -5%
					LN116104□	133,50	
					LN116105□	133,50	

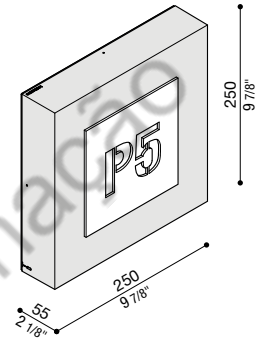

Versione speciale con cover decorativa stampata in PMMA. SPECIFICARE IN FASE D'ORDINE IL NUMERO DESIDERATO.

Special version with decorative cover moulded in PMMA. SPECIFY THE NUMBER REQUIRED WHEN ORDERING.

Version spéciale avec couverture décorative moulée en PMMA. SPECIFIER LE NUMÉRO DÉSIRÉ AU MOMENT DE LA COMMANDE.

**Art 250 Bamboo**

DIFF. POLIGLASS

IP 66 IK 10 20J xx9 CE UK CRA

LED	W	LM	REAL LM	COL.	CODE *	€	* LED COLOUR
	17	2040	1296		BL116101□	127,50	N 4000K
					BL116102□	127,50	3 3000K, lm -5%
					BL116103□	127,50	2 2700K, lm -5%
					BL116104□	127,50	
					BL116105□	127,50	

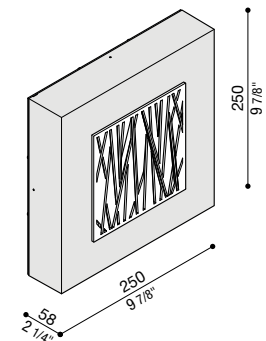

Versione speciale con cover decorativa stampata in policarbonato, ottenuta da stampaggio ad iniezione proprio.

Special version with decorative cover moulded in polycarbonate, injection moulded in-house.

Version spéciale avec couverture décorative moulée en polycarbonate, s'obtient du moulage à injection propre.

**Finishing**

	Bianco da stampaggio White Blanc moulé		Grigio antracite RAL 7021 Grey anthracite RAL 7021 Gris anthracite RAL 7021
	Nero da stampaggio Black Noir moulé		Corten Corten Corten
	Grigio High Tech RAL 9006 Grey High Tech RAL 9006 Gris High Tech RAL 9006		

**\* Led colour**

- N 4000K
- 3 3000K, lm -5%
- 2 2700K, lm -5%

**Completa il codice** sostituendo al quadrato rosso la lettera o il numero corrispondente alla temperatura colore scelta.

**Complete the code** by replacing the red box with the letter or number corresponding to the selected colour temperature.

**Compléter le code** en remplaçant le carré rouge par la lettre ou le numéro correspondant à la sélection de température couleur.

**✓ Alimentatore integrato**  
Integrated driver  
Alimentation intégrée

# Art



Disponibile in diverse colorazioni.  
Available in different colours.  
Disponibile en différentes couleurs.

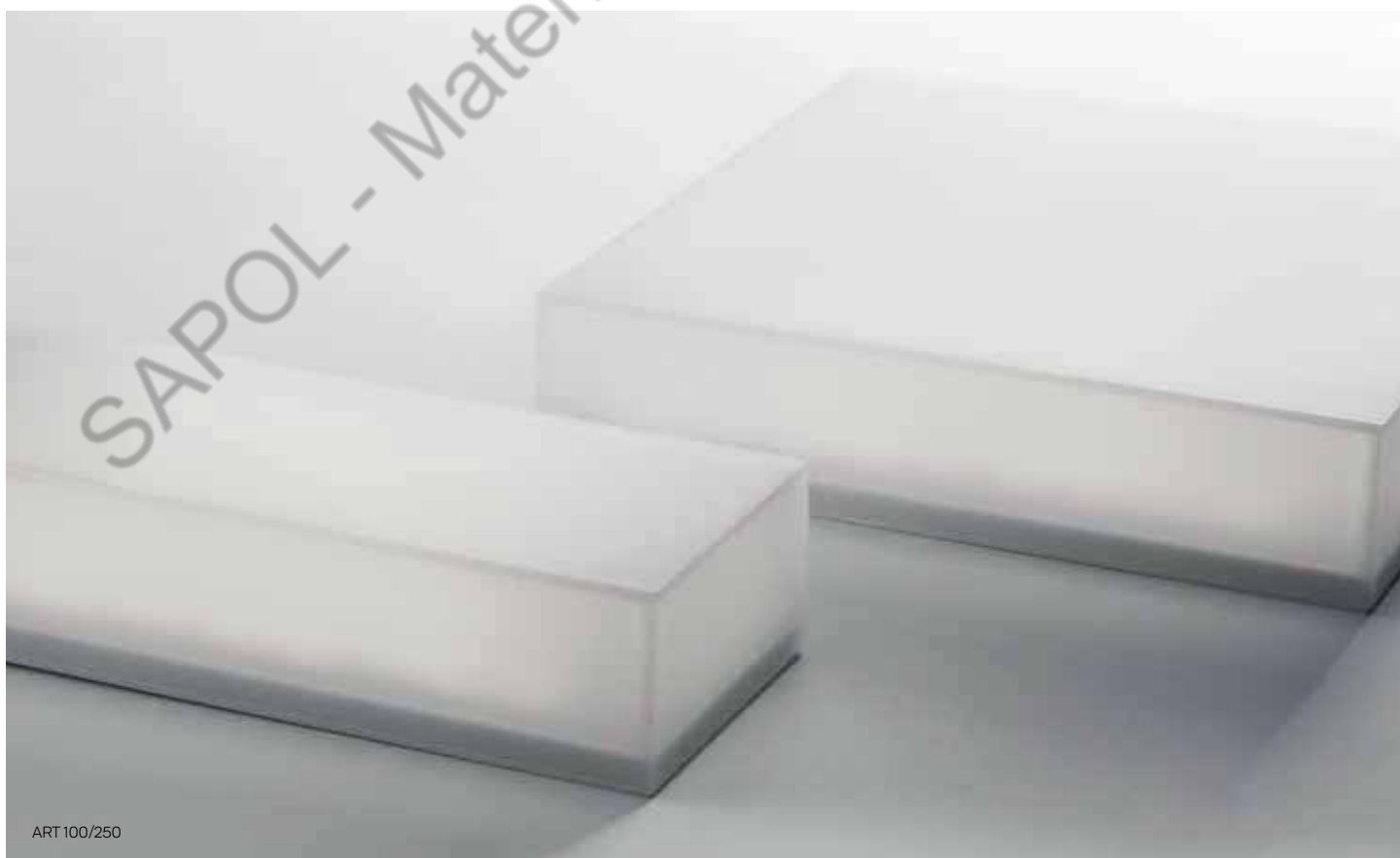



ART 100 Crop



ART 100 Code

# Art



ART 100 top black



ART 250 Mask



ART 250



# Ross



LED



indoor



outdoor



Adatto anche ad uso esterno.

Driver 220 - 240V integrato e moduli Led di ultima generazione.

Base in policarbonato, ottenuta da stampaggio ad iniezione proprio.

Diffusore in Policarbonato tripla stabilizzazione ai raggi UV, ad alto spessore con finitura PoliGLASS, ottenuto da stampaggio ad iniezione proprio.

Guarnizioni in silicone per il mantenimento del grado IP66.

Sistema di chiusura tramite grani, con cava esagonale ch.2.

Kit di fissaggio per il mantenimento del grado IP incluso.

**LED 4000K (N), 3000K (3) o 2700K (2). Alimentazione diretta 220-240V.**

**Nessun rischio fotobiologico, RGO gruppo di rischio esente (EN62471).**

**ENG** Also suitable for outdoor use. Integrated 220 - 240V ballast and latest generation Led modules. Polycarbonate base, injection moulded in-house. Very thick polycarbonate diffuser with triple UV stabilisation and PolyGLASS finish, injection moulded in-house.

Silicone gaskets to maintain IP66 rating.

Closing system by means of hex socket set screws size 2 mm.

Securing kit included to maintain IP rating.

**LED 4000K (N), 3000K (3) or 2700K (2). Integral ballast 220-240V.**

**No risk of photobiological damage, RGO group (EN62471).**

**FRA** Egalement adapté à l'usage à l'extérieur.

Driver 220 - 240V intégré et modules Led de dernière génération.

Base en polycarbonate, s'obtient du moulage à injection propre.

Diffuseur en Polycarbonate triple stabilisation aux rayons UV, très épais avec finition PoliGLASS, s'obtient du moulage à injection propre.

Joints en silicone pour maintenir le degré IP66.

Fermeture vis à six pans creux ch.2

Kit de fixation pour le maintien du degré IP inclus.

**LED 4000K (N), 3000K (3) ou 2700K (2) (blanche chaud).**

**Alimentation intégrée 220-240. Pas de risque photobiologique, RGO groupe (EN62471).**

**Ross 280**



**Ross 330**



**Outdoor  
e waterproof**



**Alimentazione diretta**

Direct power supply  
Alimentation directe

**Ross 280 Emerg.**



**Ross 330 Emerg.**



**Anni di garanzia  
sul circuito LED**

Years warranty on LED circuit  
Ans de garantie sur la source LED

# Ross

## Ross 280

DIFF.  
POLIGLASS

IP66 IK 10 20J xx9 CE UK CA

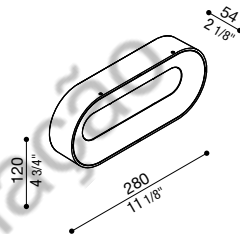

LED	W	LM	REAL LM	COL.	CODE *	€	* LED COLOUR
13	1560	895	220-240 V	[ ] [x] [ ] [x]	LL124000 [ ]	75,50	N 4000K 3 3000K, lm -5% 2 2700K, lm -5%
					LL124001 [ ]	75,50	
					LL124002 [ ]	75,50	
					LL124003 [ ]	75,50	
					LL124004 [ ]	75,50	
13	1560	895	220-240 V [ ] [x] INCLUDED	[ ] [x] [ ] [x]	LL124005 [ ]	99,00	
					LL124006 [ ]	99,00	
					LL124007 [ ]	99,00	
					LL124008 [ ]	99,00	
					LL124009 [ ]	99,00	
9	1080	583	220-240 V [ ] [x] 3h	[ ] [x] [ ] [x]	LL124025 [ ]	203,00	
					LL124026 [ ]	203,00	
					LL124027 [ ]	203,00	
					LL124028 [ ]	203,00	
					LL124029 [ ]	203,00	
13	1560	895	220-240 V [ ] [x] [ ] [x]	[ ] [x] [ ] [x]	LL124030 [ ]	99,00	
					LL124031 [ ]	99,00	
					LL124032 [ ]	99,00	
					LL124033 [ ]	99,00	
					LL124034 [ ]	99,00	

## Ross 330

DIFF.  
POLIGLASS

Disponibile versione DALI e dimmerabile.  
Available DALI and dimmable version.  
Version DALI et dimmable disponible.

IP66 IK 10 20J xx9 CE UK CA

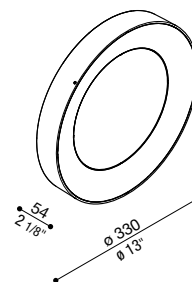

LED	W	LM	REAL LM	COL.	CODE *	€	* LED COLOUR
25	3000	1842	220-240 V	[ ] [x] [ ] [x]	LL124010 [ ]	100,00	N 4000K 3 3000K, lm -5% 2 2700K, lm -5%
					LL124011 [ ]	100,00	
					LL124012 [ ]	100,00	
					LL124013 [ ]	100,00	
					LL124014 [ ]	100,00	
25	3000	1842	220-240 V [ ] [x] INCLUDED	[ ] [x] [ ] [x]	LL124015 [ ]	124,50	
					LL124016 [ ]	124,50	
					LL124017 [ ]	124,50	
					LL124018 [ ]	124,50	
					LL124019 [ ]	124,50	
25	3000	1842	220-240 V [ ] [x] 3h	[ ] [x] [ ] [x]	LL124020 [ ]	230,50	
					LL124021 [ ]	230,50	
					LL124022 [ ]	230,50	
					LL124023 [ ]	230,50	
					LL124024 [ ]	230,50	
25	3000	1842	220-240 V [ ] [x] [ ] [x]	[ ] [x] [ ] [x]	LL124035 [ ]	124,50	
					LL124036 [ ]	124,50	
					LL124037 [ ]	124,50	
					LL124038 [ ]	124,50	
					LL124039 [ ]	124,50	
25	3000	1842	220-240 V [ ] [x] [ ] [x]	[ ] [x] [ ] [x]	LL124060 [ ]	153,00	
					LL124061 [ ]	153,00	
					LL124062 [ ]	153,00	
					LL124063 [ ]	153,00	
					LL124064 [ ]	153,00	





### Ross 280 Emerg.

DIFF. POLIGLASS

IP66 IK 10 20J xx9 CE UK CA

LED	W	LM	REAL LM	COL.	CODE *	€	* LED COLOUR
9	1080	+ LED 5W em.3H - 66lm			LL124068□	219,00	N 4000K
					LL124069□	219,00	3 3000K, lm -5%
					LL124070□	219,00	2 2700K, lm -5%
					LL124071□	219,00	
					LL124072□	219,00	

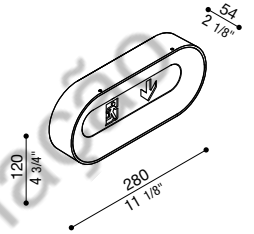

Versione fornita con kit adesivi con segnaletica di emergenza.

Version supplied with sticker kit with emergency signs.

Version fournie avec un kit d'adhésifs avec des signes de secours.

### Ross 330 Emerg.

DIFF. POLIGLASS

IP66 IK 10 20J xx9 CE UK CA

LED	W	LM	REAL LM	COL.	CODE *	€	* LED COLOUR
25	3000	+ LED 5W em.3H - 144lm			LL124073□	254,00	N 4000K
					LL124074□	254,00	3 3000K, lm -5%
					LL124075□	254,00	2 2700K, lm -5%
					LL124076□	254,00	
					LL124077□	254,00	

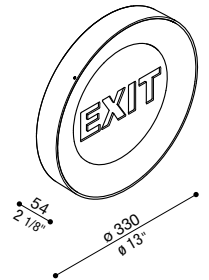

Versione fornita con kit adesivi con segnaletica di emergenza.

Version supplied with sticker kit with emergency signs.

Version fournie avec un kit d'adhésifs avec des signes de secours.

Versione fornita con kit adesivi con segnaletica di emergenza.

Version supplied with sticker kit with emergency signs.

Version fournie avec un kit d'adhésifs avec des signes de secours.



#### Finishing

	Bianco da stampaggio White Blanc moulé		Grigio antracite RAL 7021 Grey anthracite RAL 7021 Gris anthracite RAL 7021
	Nero da stampaggio Black Noir moulé		Corten Corten Corten
	Grigio High Tech RAL 9006 Grey High Tech RAL 9006 Gris High Tech RAL 9006		

#### \* Led colour

- N 4000K
- 3 3000K, lm -5%
- 2 2700K, lm -5%

**Completa il codice** sostituendo al quadrato rosso la lettera o il numero corrispondente alla temperatura colore scelta.

**Complete the code** by replacing the red box with the letter or number corresponding to the selected colour temperature.

**Compléter le code** en remplaçant le carré rouge par la lettre ou le numéro correspondant à la sélection de température couleur.

**Alimentatore integrato**  
Integrated driver  
Alimentation intégrée

# Ross



Colori disponibili.  
Available colours.  
Couleurs disponibles.



## Disponibile versione corridor function.

Funzione a risparmio energetico che permette di configurare un profilo di illuminazione su due livelli. Il prodotto funziona costantemente ad un'intensità luminosa ridotta, raggiungendo la massima efficienza al passaggio, tramite un sensore di prossimità.

## Available version corridor function.

Energy saving function that allows 2 different levels of lighting configuration. The product constantly works at a reduced intensity and thanks to a movement detector, luminous intensity is automatically increased at passage.

## Disponibile versione corridor function.

Fonction d'économie d'énergie qui vous permet de configurer un profil d'éclairage sur deux niveaux. Le produit fonctionne constamment à une intensité lumineuse réduite, atteignant une efficacité maximale au passage, grâce à un détecteur de proximité.



Funzionamento luce continua  
(rete+emergenza 3h) - SA

Maintained emergency 3h.

Fonctionnement continu 3h.



Ross 330  
Ross 280



# Ross





Ross 280

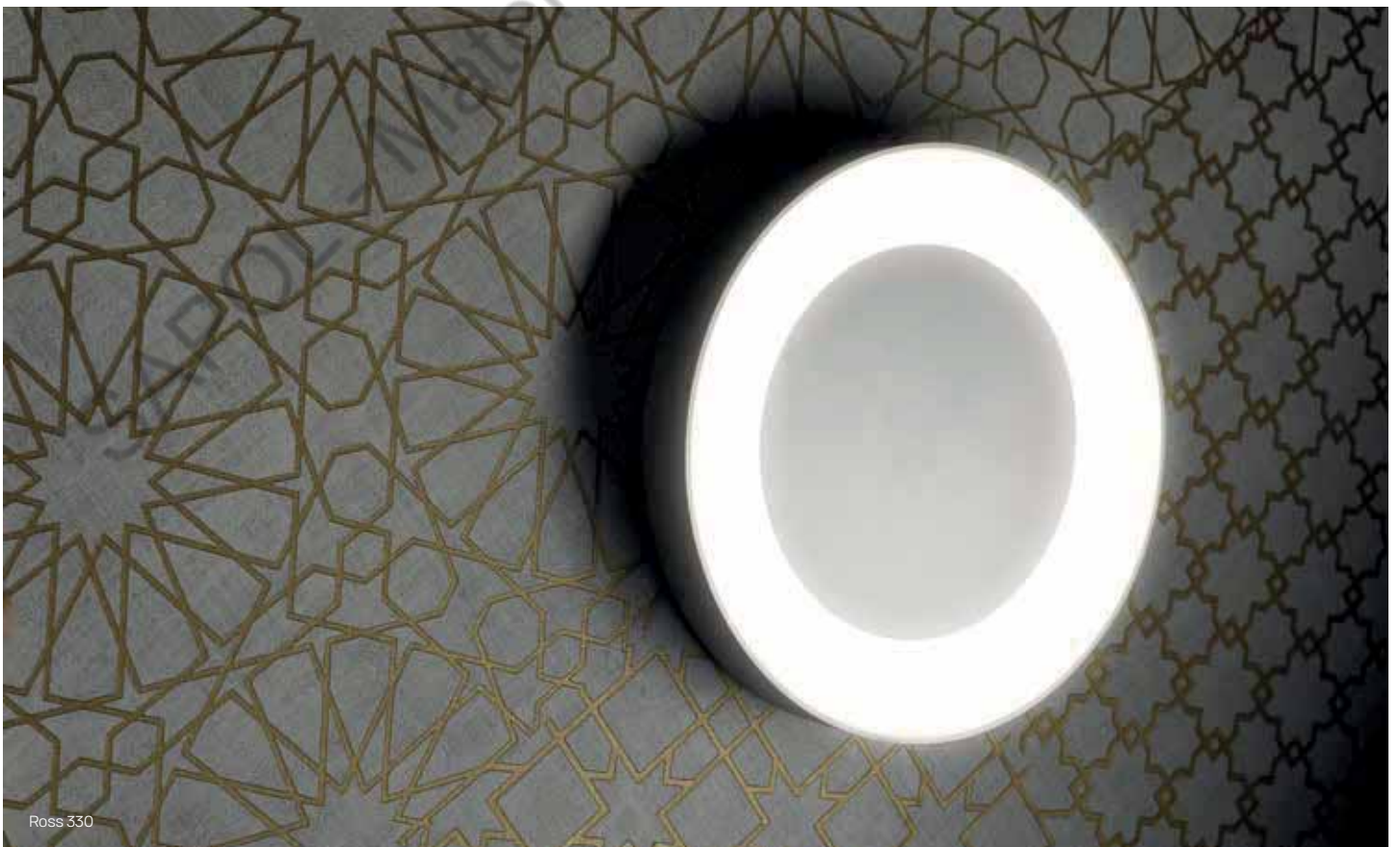

Ross 330



# Flo



LED

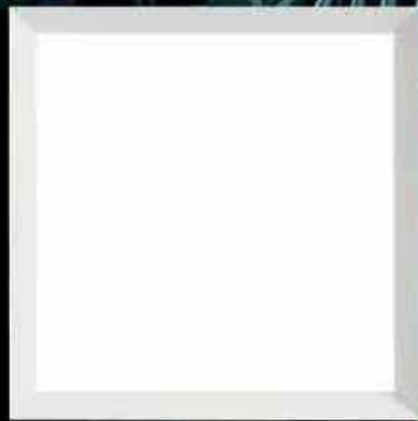
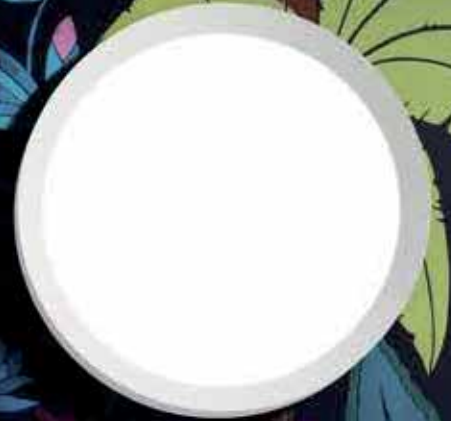
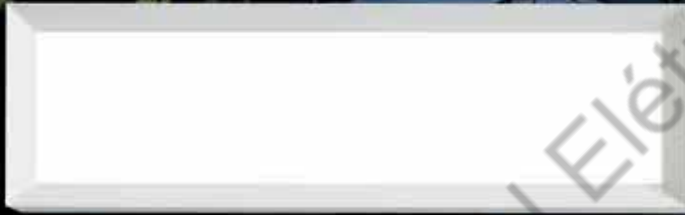

indoor



Adatto per l'installazione a parete e soffitto. Plafone a singola emissione per applicazione indoor.  
 Driver 220-240V integrato. Corpo in alluminio estruso, verniciato con resine di poliestere stabilizzate ai raggi UV.  
 Diffusore in policarbonato opale antigraffio stabilizzato ai raggi UV. Pannello LGP in PMMA per la diffusione omogenea della luce. Bulloneria in acciaio zincato.  
 Fissaggio tramite staffa in acciaio zincato e perni per molle a scatto.  
 Completo di kit di sicurezza per il montaggio.  
**LED 4000K (N), 3000 K (3) e 2700 (2). Alimentazione diretta 220-240V.**  
**Nessun rischio fotobiologico, RGO gruppo di rischio esente (EN62471).**

**ENG** Suitable for wall and ceiling installation. Single emission lighting fixture for indoor application. Integrated 220-240V driver. Extruded aluminum body painted with UV stabilized polyester resins. Scratch-resistant opal polycarbonate diffuser stabilized to UV rays. PMMA LGP panel for homogeneous light diffusion. Galvanized steel screws. Fixing by bracket made of galvanized steel and pins for snap springs. with installation safety kit.  
**LED 4000K (N), 3000K (3) or 2700K (2). Integral ballast 220-240V. No risk of photobiological damage, RGO group (EN 2471).**

**FRA** Également adapté pour l'installation au mur et au plafond. Luminaire à émission unique adaptée à l'application intérieure. Driver 220-240V intégré. Corps en aluminium extrudé, peint avec des résines en polyester stabilisées aux rayons UV. Diffuseur en polycarbonate opalin anti-rayures stabilisé aux rayons UV. Panneau LGP en PMMA pour une diffusion homogène de la lumière. Visserie en acier galvanisé. Fixation au moyen d'un support en acier galvanisé et de goupilles pour ressorts à déclic. Fourni avec un kit de sécurité pour le montage.  
**LED 4000K (N), 3000K (3) ou 2700K (2) (blanche chaud). LED Direct 220-240V. Pas de risque photobiologique, RGO groupe (EN62471).**



**Flo Q 150**

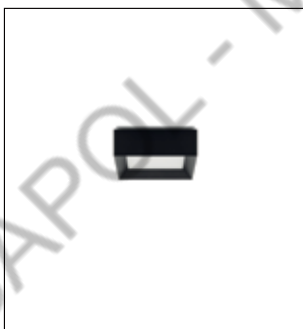

**Flo Q 300**



**Flo Q 500**



**Alimentazione diretta**  
 Direct power supply  
 Alimentation directe



**Dimmerabile**  
 Dimmable  
 Dimmable

**Flo T 300**



**Flo T 500**



**Flo R**

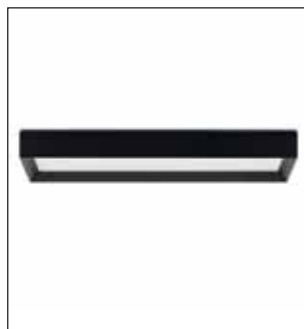

**Anni di garanzia sul circuito LED**  
 Years warranty on LED circuit  
 Ans de garantie sur la source LED

# Flo

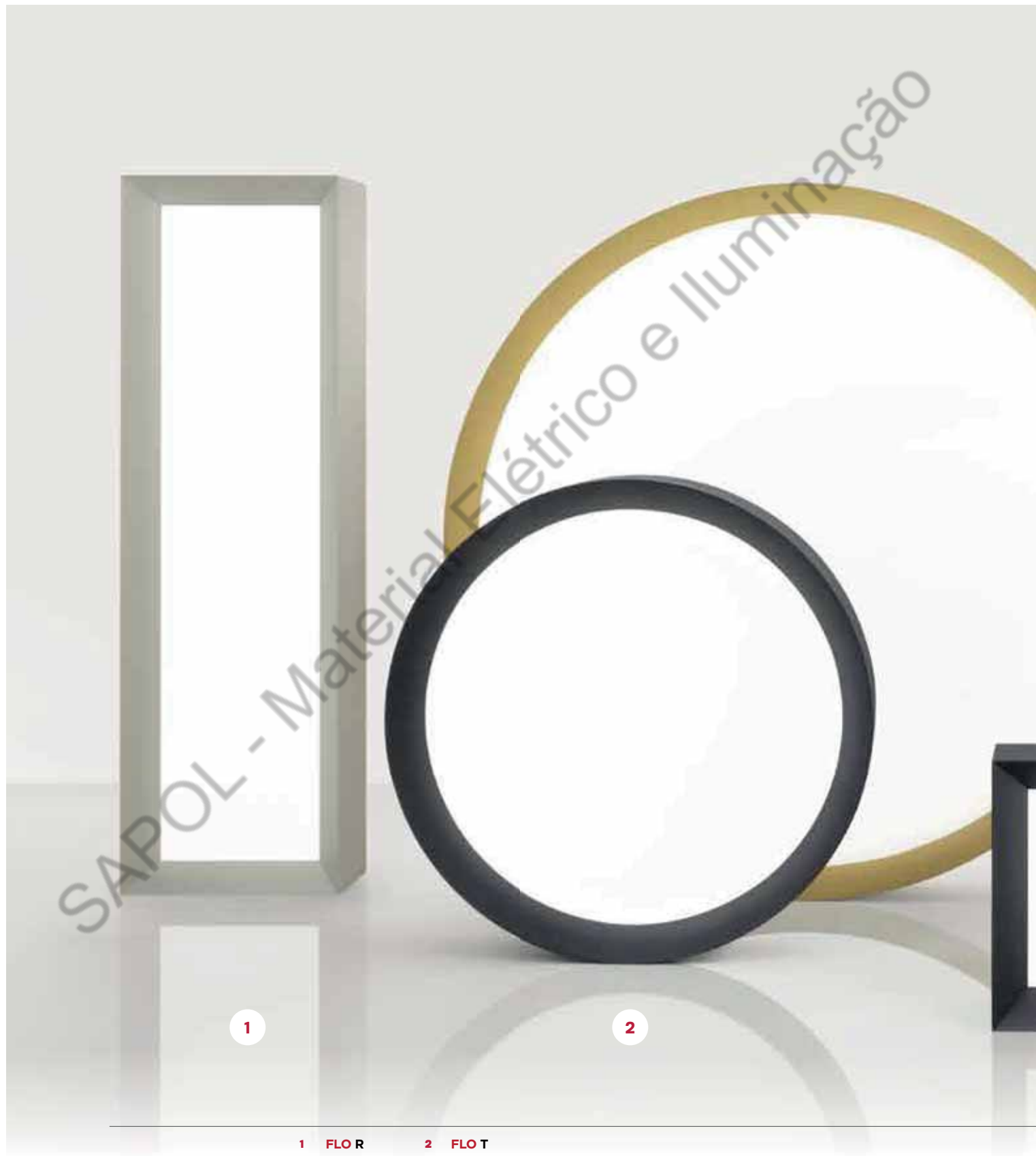

1

2

1 FLO R

2 FLO T





# Flo

## Flo Q 150

DIFF.  
OPAL.

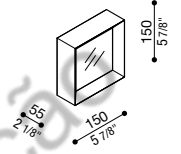

IP 20 IK 06 1J xx3 C  $\text{\textcircled{UK}}$   $\text{\textcircled{CA}}$

LED	W	LM	REAL LM		COL.	CODE *	€	* LED COLOUR
10	900	481	220-240 V	☐	LL134000	91,50	N 4000K 3 3000K, lm -5% 2 2700K, lm -5%	
					LL134001	91,50		
					LL134002	91,50		
					LL134003	91,50		
10	900	481	220-240 V DALI PUSH	☐	LM134000	172,50		
					LM134001	172,50		
					LM134002	172,50		
					LM134003	172,50		
10	900	481	220-240 V 1-10V	☐	LD134000	172,50		
					LD134001	172,50		
					LD134002	172,50		
					LD134003	172,50		

## Flo R

DIFF.  
OPAL.

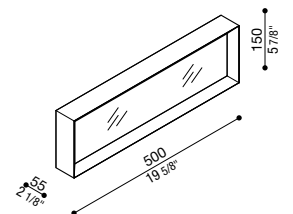

IP 20 IK 06 1J xx3 C  $\text{\textcircled{UK}}$   $\text{\textcircled{CA}}$

LED	W	LM	REAL LM		COL.	CODE *	€	* LED COLOUR
39	4200	2184	220-240 V	☐	LL134012	172,50	N 4000K 3 3000K, lm -5% 2 2700K, lm -5%	
					LL134013	172,50		
					LL134014	172,50		
					LL134015	172,50		
39	4200	2184	220-240 V DALI	☐	LM134012	254,00		
					LM134013	254,00		
					LM134014	254,00		
					LM134015	254,00		
39	4200	2184	220-240 V 1-10V PUSH	☐	LD134012	254,00		
					LD134013	254,00		
					LD134014	254,00		
					LD134015	254,00		
39 + LED 7W em.3H - 152lm	4200	2184	220-240 V 	☐	LE134012	254,00		
					LE134013	254,00		
					LE134014	254,00		
					LE134015	254,00		



### Flo Q 300

DIFF. OPAL.

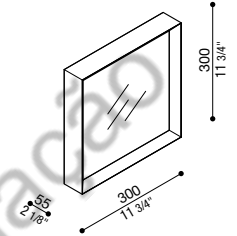

IP 20 IK 06 1J xx3 ( UK CRA

LED	W	LM	REAL LM	COL.	CODE *	€	* LED COLOUR
30	2800	2169	⊕ ✓ 220-240 V	[Color swatches]	LL134004□	149,00	[N] 4000K [3] 3000K, lm -5% [2] 2700K, lm -5%
					LL134005□	149,00	
					LL134006□	149,00	
					LL134007□	149,00	
30	2800	2169	⊕ ✓ 220-240 V DALI	[Color swatches]	LM134004□	219,00	
					LM134005□	219,00	
					LM134006□	219,00	
					LM134007□	219,00	
30	2800	2169	⊕ ✓ 220-240 V 1-10V PUSH	[Color swatches]	LD134004□	219,00	
					LD134005□	219,00	
					LD134006□	219,00	
					LD134007□	219,00	
30 + LED 7W em.3H - 152lm	2800	2169	⊕ ✓ 220-240 V	[Color swatches]	LE134004□	230,50	
					LE134005□	230,50	
					LE134006□	230,50	
					LE134007□	230,50	

### Flo Q 500

DIFF. OPAL.

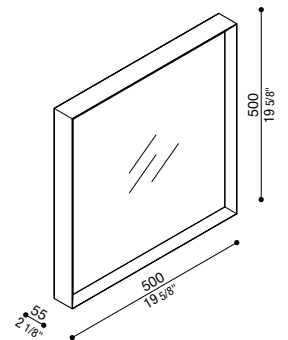

IP 20 IK 06 1J xx3 ( UK CRA

LED	W	LM	REAL LM	COL.	CODE *	€	* LED COLOUR
39	4200	3247	⊕ ✓ 220-240 V	[Color swatches]	LL134008□	254,00	[N] 4000K [3] 3000K, lm -5% [2] 2700K, lm -5%
					LL134009□	254,00	
					LL134010□	254,00	
					LL134011□	254,00	
39	4200	3247	⊕ ✓ 220-240 V 1-10V PUSH DALI	[Color swatches]	LD134008□	334,50	
					LD134009□	334,50	
					LD134010□	334,50	
					LD134011□	334,50	
39 + LED 7W em.3H - 223lm	4200	3247	⊕ ✓ 220-240 V	[Color swatches]	LE134008□	334,50	
					LE134009□	334,50	
					LE134010□	334,50	
					LE134011□	334,50	

**Finishing**

Bianco RAL 9003 White RAL 9003 Blanc RAL 9003	Dark Grey RAL 7021 Dark Grey RAL 7021 Gris Foncé RAL 7021
Light Grey RAL 7044 Light Grey RAL 7044 Gris Pale RAL 7044	Gold Gold Gold

**\* Led colour**

- [N] 4000K
- [3] 3000K, lm -5%
- [2] 2700K, lm -5%

**Completa il codice**  
sostituendo al quadrato rosso la lettera o il numero corrispondente alla temperatura colore scelta.

**Complete the code**  
by replacing the red box with the letter or number corresponding to the selected colour temperature.

**Compléter le code**  
en remplaçant le carré rouge par la lettre ou le numéro correspondant à la sélection de température couleur.

**Alimentatore integrato**  
Integrated driver  
Alimentation intégrée

# Flo

## Flo T 300

DIFF.  
OPAL.

IP 20 IK 06 1J xx3 (UK CA)

LED	W	LM	REAL LM	COL.	CODE *	€	* LED COLOUR
30	2800	2136	220-240 V	LL134016	149,00	N 4000K 3 3000K, lm -5% 2 2700K, lm -5%	
				LL134017	149,00		
				LL134018	149,00		
				LL134019	149,00		
30	2800	2136	220-240 V DALI	LM134016	219,00		
				LM134017	219,00		
				LM134018	219,00		
				LM134019	219,00		
30	2800	2136	220-240 V 1-10V PUSH	LD134016	219,00		
				LD134017	219,00		
				LD134018	219,00		
				LD134019	219,00		
30	2800	2136	220-240 V 	LE134016	230,50		
				LE134017	230,50		
				LE134018	230,50		
				LE134019	230,50		

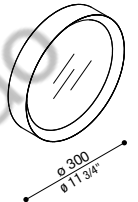

## Flo T 500



DIFF.  
OPAL.

IP 20 IK 06 1J xx3 (UK CA)

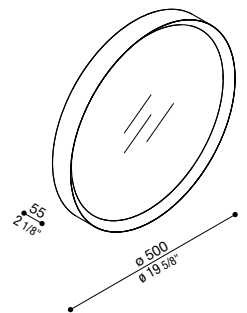
LED	W	LM	REAL LM	COL.	CODE *	€	* LED COLOUR
45	4200	3517	220-240 V	LL134020	254,00	N 4000K 3 3000K, lm -5% 2 2700K, lm -5%	
				LL134021	254,00		
				LL134022	254,00		
				LL134023	254,00		
45	4200	3517	220-240 V 1-10V PUSH DALI	LD134020	334,50		
				LD134021	334,50		
				LD134022	334,50		
				LD134023	334,50		
45	4200	3517	220-240 V 	LE134020	334,50		
				LE134021	334,50		
				LE134022	334,50		
				LE134023	334,50		



### Finishing

	Bianco RAL 9003 White RAL 9003 Blanc RAL 9003		Dark Grey RAL 7021 Dark Grey RAL 7021 Gris Foncé RAL 7021
	Light Grey RAL 7044 Light Grey RAL 7044 Gris Pale RAL 7044		Gold Gold Gold

### \* Led colour

- N 4000K
- 3 3000K, lm -5%
- 2 2700K, lm -5%

**Completa il codice**  
sostituendo al quadrato rosso la lettera o il numero corrispondente alla temperatura colore scelta.

**Complete the code**  
by replacing the red box with the letter or number corresponding to the selected colour temperature.

**Compléter le code**  
en remplaçant le carré rouge par la lettre ou le numéro correspondant à la sélection de température couleur.

### ✓ Alimentatore integrato

Integrated driver  
Alimentation intégrée



# Flo



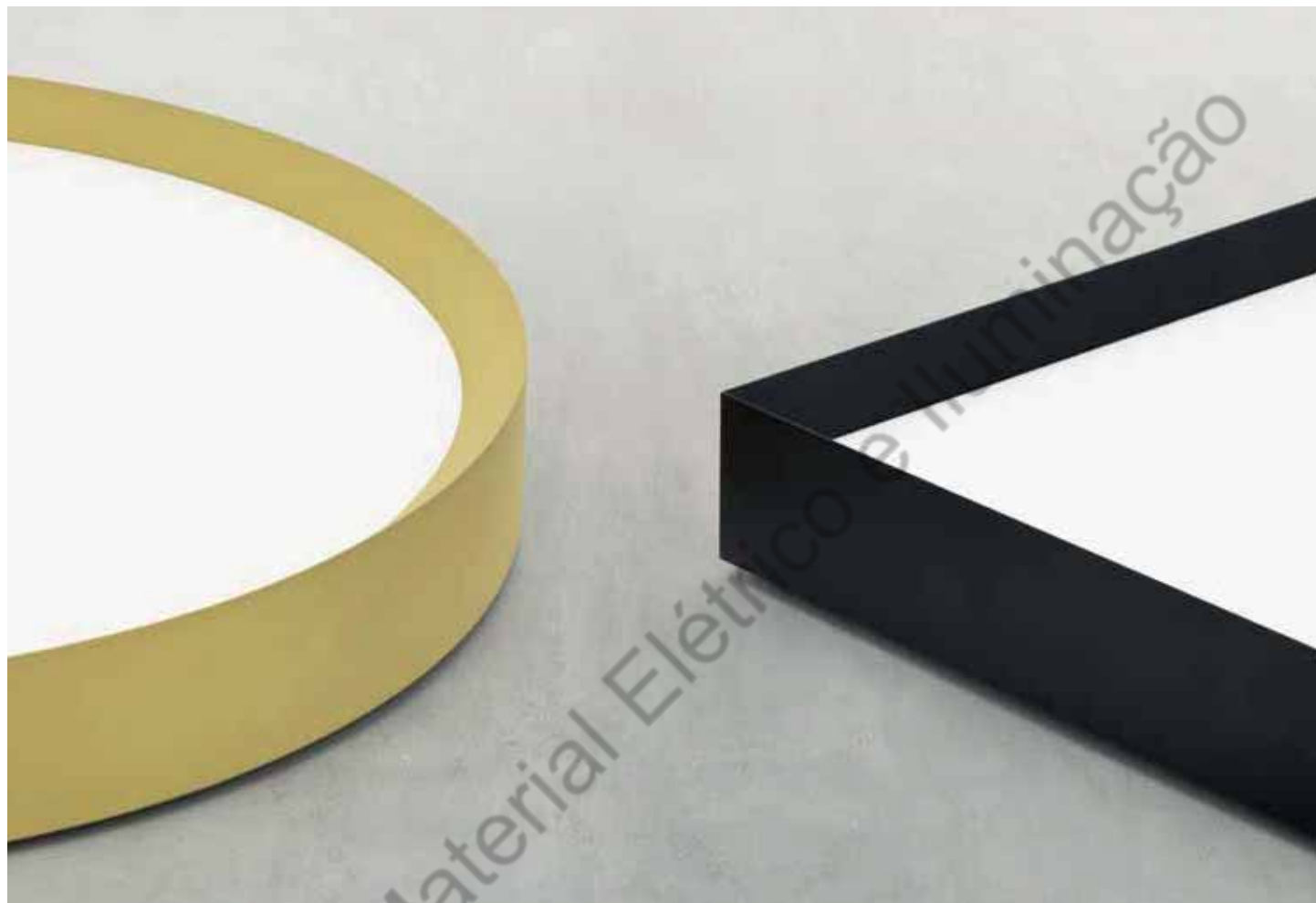

Versioni disponibili.  
Available versions.  
Versions disponibles.



# Flo



FLO Q150



FLO R



FLOT 300



FLOT 500



FLOT 500

# Flo



FLO Q 300



FLO Q 500



FLO Q 300



# Flo







# Kobo 110

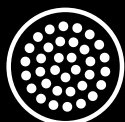

LED



indoor



outdoor

**ACCESSORI**

Accessories / Accessoires

Pag. 71



Adatto anche ad uso esterno.

Base in policarbonato ottenuta da stampaggio ad iniezione proprio. Diffusore in Policarbonato tripla stabilizzazione ai raggi UV, ad alto spessore, ottenuto da stampaggio ad iniezione proprio.

Guarnizioni in silicone per il mantenimento del grado IP66.

Apparecchio inaccessibile fornito con 0,15 m di cavo di alimentazione H05RN-F pre – cablato.

Bulloneria in acciaio inox A4.

**LED 4000K (N), 3000K (3) o 2700K (2). LED a tensione di rete. Nessun rischio fotobiologico, RG0 gruppo di rischio esente (EN62471).**

**ENG** Suitable for indoor and outdoor use. Polycarbonate base, injection moulded in-house. Very thick polycarbonate diffuser with triple UV stabilisation, injection moulded in-house.

Silicone gaskets to maintain IP66 rating. Inaccessible device, provided with 0.15 m of prewired power cable H05RN-F. A4 stainless steel screws. **LED 4000K (N), 3000K (3) or 2700K (2). LED AC direct. No risk of photobiological damage, RG0 group (EN62471).**

**FRA** Également adapté pour l'usage à l'extérieur. Base en polycarbonate, s'obtient du moulage à injection propre. Diffuseur en Polycarbonate triple stabilisation aux rayons UV, très épais, s'obtient du moulage à injection propre. Joints en silicone pour maintenir le degré IP66. Appareil fourni avec 0.15 m de câble d'alimentation H05RN-F-pré-câblé. Visserie en acier inox type A4.

**LED 4000K (N), 3000K (3) ou 2700K (2) (blanche chaud). LED Direct 220-240V. Pas de risque photobiologique, RG0 groupe (EN62471).**

**Kobo 110**



**Kobo 110 BK**



**Outdoor  
e waterproof**



**Kobo 110 Code**



**Pre-cablato**  
Pre-wired  
Pré-câblé



**Anni di garanzia  
sul circuito LED**  
Years warranty on LED circuit  
Ans de garantie sur la source LED

# Kobo 110



**1 KOBO 110 POLIGLASS**  
+ BOX DERIVAZIONE  
KOBO

**2 KOBO 110 BK**

**3 KOBO 110**  
SEMI-  
TRASPARENTE



4

5

4 **KOBO 110 CODE**

5 **KOBO 110 BK**  
+ CASSETTA  
DERIVAZIONE STAGNA  
100x100x50

# Kobo 110

<b>Kobo 110</b>		<b>DIFF. POLIGLASS</b>		<b>DIFF. SEMITRASP.</b>								
<b>IP 66 IK 08 5J xx7</b>												
<b>LED</b>	<b>W</b>	<b>LM</b>	<b>REAL LM</b>	<b>COL.</b>	<b>CODE *</b>	<b>€ * LED COLOUR</b>						
	8	1000	570-700		LL130000□	46,00						
					LL130001□	<table border="1"> <tr><td>N</td><td>4000K</td></tr> <tr><td>3</td><td>3000K, lm -5%</td></tr> <tr><td>2</td><td>2700K, lm -5%</td></tr> </table>	N	4000K	3	3000K, lm -5%	2	2700K, lm -5%
N	4000K											
3	3000K, lm -5%											
2	2700K, lm -5%											

<b>Kobo 110 BK</b>		<b>DIFF. SEMITRASP.</b>										
<b>IP 66 IK 08 5J xx7</b>												
<b>LED</b>	<b>W</b>	<b>LM</b>	<b>REAL LM</b>	<b>COL.</b>	<b>CODE *</b>	<b>€ * LED COLOUR</b>						
	8	1000	130		LL130002□	52,50						
						<table border="1"> <tr><td>N</td><td>4000K</td></tr> <tr><td>3</td><td>3000K, lm -5%</td></tr> <tr><td>2</td><td>2700K, lm -5%</td></tr> </table>	N	4000K	3	3000K, lm -5%	2	2700K, lm -5%
N	4000K											
3	3000K, lm -5%											
2	2700K, lm -5%											

Diffusore Fumè.

Diffuser Fumè.

Diffuseur Fumè.

<b>Kobo 110 Code</b>		<b>DIFF. POLIGLASS</b>				
<b>IP 66 IK 08 5J xx7</b>						
<b>LED</b>	<b>W</b>	<b>LM</b>	<b>REAL LM</b>	<b>COL.</b>	<b>CODE *</b>	<b>€ * LED COLOUR</b>
	8	1000				
					LL130004□	76,00
					LL130005□	76,00
					LL130006□	76,00
					LL130007□	76,00
					LL130008□	76,00

Versione speciale con cover personalizzata in PMMA.  
SPECIFICARE IN FASE D'ORDINE LA PERSONALIZZAZIONE  
RICHIESTA.

Special version with decorative cover moulded in PMMA.  
SPECIFY THE CUSTOMIZATION REQUIRED WHEN ORDERING.

Version spéciale avec Couverture décorative moulée en  
PMMA  
SPÉCIFIER LA PERSONNALISATION DÉSIRÉE AU MOMENT DE  
LA COMMANDE.

## Finishing

	Nero da stampaggio Black Noir moulé
	Grigio High Tech RAL 9006 Grey High Tech RAL 9006 Gris High Tech RAL 9006
	Grigio antracite RAL 7021 Grey anthracite RAL 7021 Gris anthracite RAL 7021

	Corten Corten Corten
	Rame Copper Cuivre

## \* Led colour

N	4000K
3	3000K, lm -5%
2	2700K, lm -5%

**Completa il codice**  
sostituendo al quadrato rosso la lettera o il numero corrispondente alla temperatura colore scelta.

**Complete the code**  
by replacing the red box with the letter or number corresponding to the selected colour temperature.

**Compléter le code**  
en remplaçant le carré rouge par la lettre ou le numéro correspondant à la sélection de température couleur.

## ✔ Alimentatore integrato

Integrated driver  
Alimentation intégrée



**ACCESSORI**

Accessories / Accessoires

**Box derivazione Kobo**

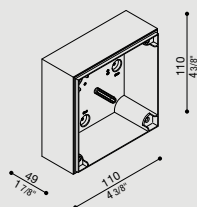

Box di derivazione per montaggio a parete (non per incasso).  
 Predisposto per installazione su scatole standard 502 e 503.  
 Corpo in policarbonato completo di dima di foratura per ingresso tubo standard  $\varnothing$ 16-20 mm.

**Junction box Kobo**  
 Junction box for wall mounting (not recess).  
 Suitable for installation on standard boxes 502 and 503.  
 Polycarbonate body complete with drilling template for standard tube  $\varnothing$ 16-20 mm.

**Boîte de dérivation Kobo**  
 Boîte de dérivation pour montage en saïlle (pas à encastrer).  
 Convient pour l'installation sur des boîtes standards 502 et 503.  
 Corps en polycarbonate complet avec gabarit de perçage pour entrée de tube standard  $\varnothing$ 16-20 mm.

COL.	CODE	€
	LB1300001	14,00
	LB1300002	14,00
	LB1300003	14,00
	LB1300004	14,00
	LB1300005	14,00

**Sensore di Movimento**

Utilizzo in remoto  
 For remote use  
 Utilisation à distance

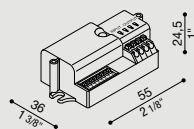

Kit di montaggio per sensore di movimento crepuscolare.

**Motion sensor**  
 Mounting kit for motion sensor.

**Détecteur de présence**  
 Kit de montage pour détecteur de mouvement crépusculaire.

COL.	CODE	€
	LB11295	48,00

**Morsettiere**  
 Terminal blocks



**Scaricatori SPD**  
 Surge protector devices



Pag. 448



Box disponibile in diverse colorazioni.  
 Box available in different colours.  
 Box disponible en différentes couleurs.



# Kobo 110

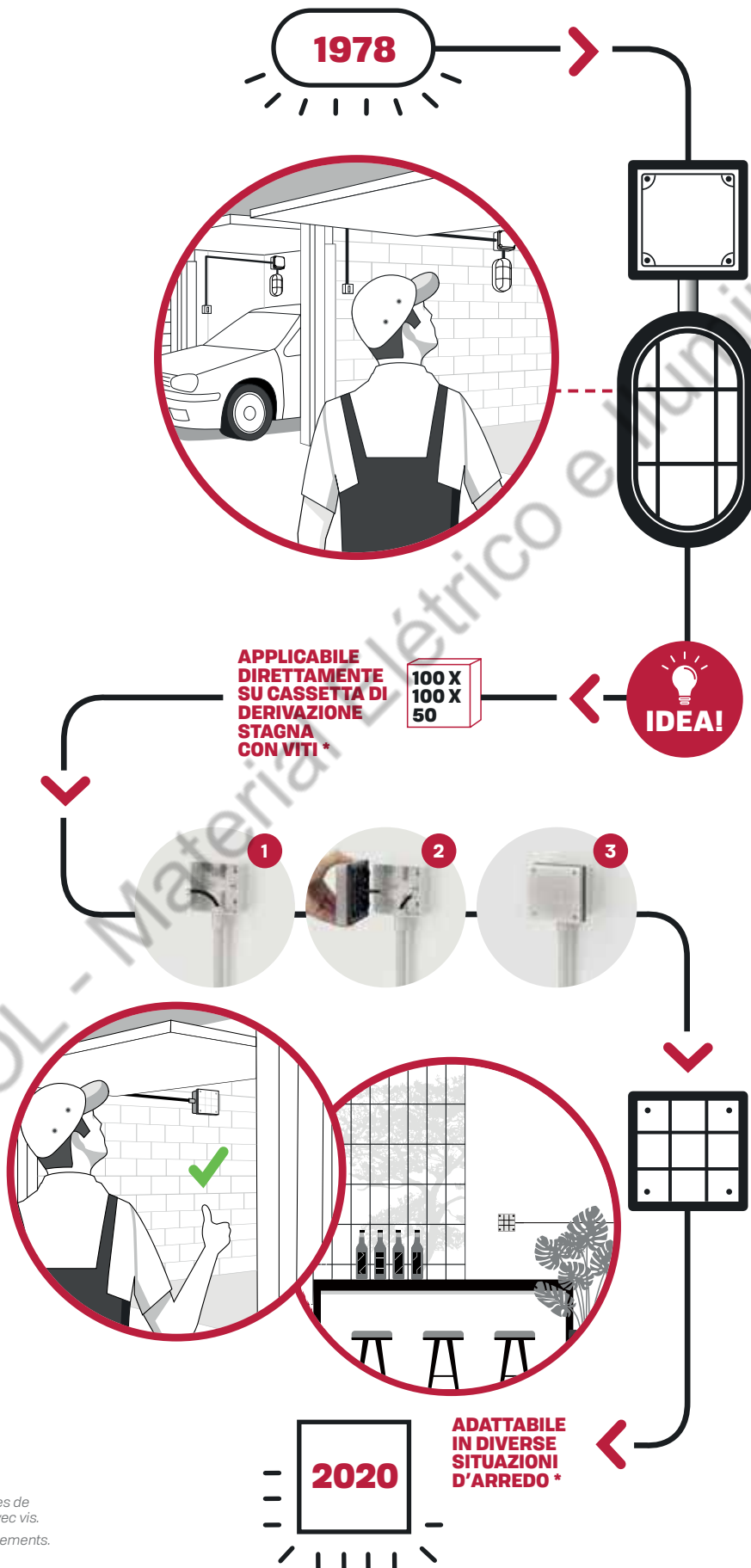

\* Suitable for standard 100x100x50 junction boxes with screws.  
Suitable for several settings.

\* Adaptable directement sur les boîtes de dérivation étanches 100x100x50 avec vis.  
Adaptable dans différents environnements.



Guarnizione per il mantenimento del grado di protezione dell'impianto.

Gasket that maintains the protection degree of the installation.

Joint d'étanchéité pour maintenir le degré de protection du circuit.

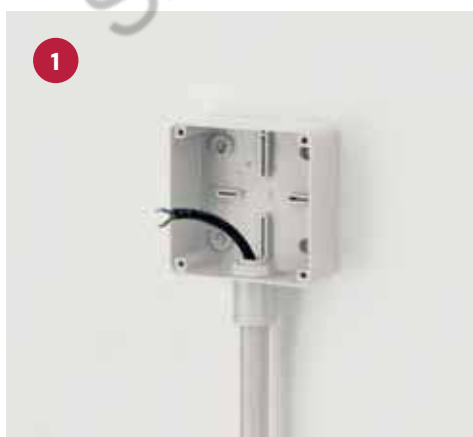

# Kobo 110





Kobo 110 Code



Kobo 110



Kobo 110 BK

# Kobo 110







Kobo 110 BK

# Pik

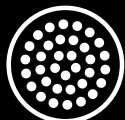

LED

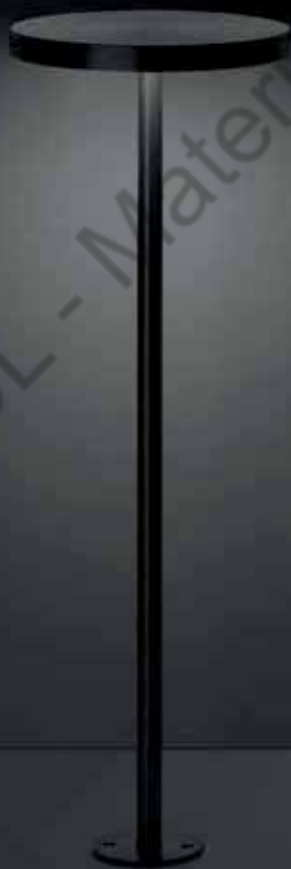

outdoor

**ACCESSORI**

Accessories / Accessoires

Pag. 84



Adatto per l'installazione a terra e parete.

Corpo e palo in alluminio anodizzato EN-6026; elevata resistenza all'ossidazione grazie al trattamento di anodizzazione. Diffusore in policarbonato ottico con finitura PoliGLASS, tramite stampaggio ad iniezione. Guarnizioni in silicone.

**PIK:** Apparecchio inaccessibile, fornito con 2m di cavo di alimentazione H05RN-F pre-cablato.

**PIK WALL:** Apparecchio inaccessibile, fornito con 0,2m di cavo di alimentazione H05RN-F pre-cablato.

Bulloneria in acciaio inox A4. Disponibile versione LED a tensione di rete. Disponibile versione 24V.

**LED 4000K (N), 3000K (3) o 2700K (2). LED a tensione di rete. Nessun rischio fotobiologico; RG0 gruppo di rischio esente (EN62471).**

**ENG** Suitable for floor and wall installation. Body and pole in EN-6026 anodized aluminium; high resistance to oxidation thanks to the anodizing treatment. Optical polycarbonate diffuser with PoliGLASS finish, obtained by injection moulding. Silicone gaskets.

**PIK:** inaccessible fixture, supplied with 2m of pre-wired H05RN-F power cable.

**PIK WALL:** inaccessible fixture, supplied with 0,2m of pre-wired H05RN-F power cable. Stainless steel A4 bolts. Available LED AC direct.

Available 24V version.

**LED 4000K (N), 3000K (3) or 2700K (2). LED AC Direct. No risk of photobiological damage; RG0 risk group (EN62471).**

**FRA** Convient pour une installation au sol et en saillie.

Corps et poteau en aluminium anodisé EN-6026; haute résistance à l'oxydation grâce au traitement d'anodisation.

Diffuseur en polycarbonate optique avec finition PoliGLASS, obtenu au moyen d'un moulage à injection. Joints en silicone.

**PIK:** Appareil câblé en usine, fourni précâblé avec 2 m de câble d'alimentation H05RN-F.

**PIK WALL:** Appareil câblé en usine, fourni précâblé avec 0,2 m de câble d'alimentation H05RN-F. Visserie en acier inox type A4. Disponible en LED AC direct 220-240V. Disponible en version 24V.

**LED 4000K (N), 3000K (3) ou 2700K (2). Led direct 220-240V. Pas de risque photobiologique; RG0 groupe (EN62471).**

**Pik 80 H 250**



**Pik 80 H 500**



**Pik 160 H 250**



**Pik 160 H 500**



**Pik 80 Wall**



**Pik 160 Wall**



**Outdoor e waterproof**



**Anodizzazione**  
Anodisation  
Anodisation



**Pre-cablato**  
Pre-wired  
Pré-câblé



**Anni di garanzia sul circuito LED**  
Years warranty on LED circuit  
Ans de garantie sur la source LED

# Pik



1 PIK 160 H 500

2 PIK 80 H 500



3 PIK 160 H 250

4 PIK 80 H 250

5 PIK WALL



# Pik

## Pik 80 H 250

DIFF.  
POLIGLASS

IP 65 IK 08 5J xx7  $\text{CE}$   $\frac{\text{UK}}{\text{CA}}$

LED	W	LM	REAL LM	COL.	CODE *	€	* LED COLOUR
4,5	520	245	AC DIRECT		LL135000	150,50	N 4000K 3 3000K, lm -5% 2 2700K, lm -5%
					LL135001	150,50	
					LL135002	150,50	
					LL135003	150,50	
4,5	520	245	24V		LT135000	157,50	
					LT135001	157,50	
					LT135002	157,50	
					LT135003	157,50	

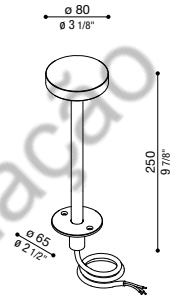

## Pik 80 H 500

DIFF.  
POLIGLASS

IP 65 IK 08 5J xx7  $\text{CE}$   $\frac{\text{UK}}{\text{CA}}$

LED	W	LM	REAL LM	COL.	CODE *	€	* LED COLOUR
4,5	520	245	AC DIRECT		LL135004	185,50	N 4000K 3 3000K, lm -5% 2 2700K, lm -5%
					LL135005	185,50	
					LL135006	185,50	
					LL135007	185,50	
4,5	520	245	24V		LT135004	193,00	
					LT135005	193,00	
					LT135006	193,00	
					LT135007	193,00	

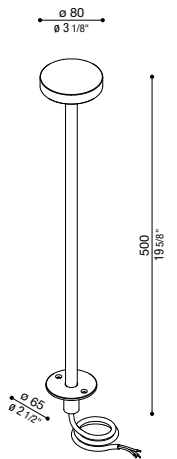

## Pik 160 H 250

DIFF.  
POLIGLASS

IP 65 IK 08 5J xx7  $\text{CE}$   $\frac{\text{UK}}{\text{CA}}$

LED	W	LM	REAL LM	COL.	CODE *	€	* LED COLOUR
9	1035	780	AC DIRECT		LL135100	209,00	N 4000K 3 3000K, lm -5% 2 2700K, lm -5%
					LL135101	209,00	
					LL135102	209,00	
					LL135103	209,00	
9	1035	780	24V		LT135100	216,50	
					LT135101	216,50	
					LT135102	216,50	
					LT135103	216,50	

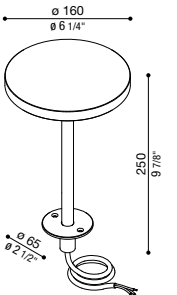



**Pik 160 H 500**

DIFF. POLIGLASS

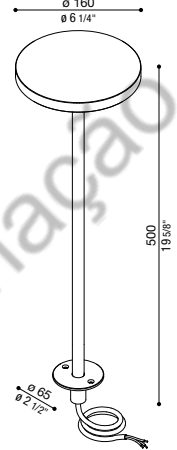

IP 65 IK 08 5J xx7 CE UK CA

LED	W	LM	REAL LM	COL.	CODE *	€	* LED COLOUR
9	1035	780	AC DIRECT	LL135104	244,50	N 4000K 3 3000K, Im -5% 2 2700K, Im -5%	
				LL135105	244,50		
				LL135106	244,50		
				LL135107	244,50		
9	1035	780	24V	LT135104	251,00		
				LT135105	251,00		
				LT135106	251,00		
				LT135107	251,00		

**Pik 80 Wall**

DIFF. POLIGLASS

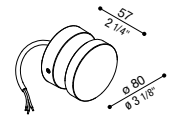

IP 65 IK 08 5J xx7 CE UK CA

LED	W	LM	REAL LM	COL.	CODE *	€	* LED COLOUR
4,5	520	245	AC DIRECT	LL135016	139,00	N 4000K 3 3000K, Im -5% 2 2700K, Im -5%	
				LL135017	139,00		
				LL135018	139,00		
				LL135019	139,00		

Fornito con rosone per il fissaggio.  
Compreso di connettori gel rapidi IP68 per il cablaggio.

Supplied with mounting base.  
Including quick gel connectors IP68 for wiring.

Livré avec support de fixation.  
Compris des connecteurs gel rapides IP 68 pour le câblage.

**Pik 160 Wall**

DIFF. POLIGLASS

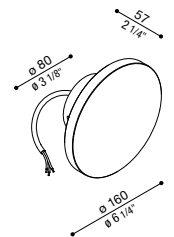

IP 65 IK 08 5J xx7 CE UK CA

LED	W	LM	REAL LM	COL.	CODE *	€	* LED COLOUR
9	1035	780	AC DIRECT	LL135116	197,00	N 4000K 3 3000K, Im -5% 2 2700K, Im -5%	
				LL135117	197,00		
				LL135118	197,00		
				LL135119	197,00		

Fornito con rosone per il fissaggio.  
Compreso di connettori gel rapidi IP 68 per il cablaggio.

Supplied with mounting base.  
Including quick gel connectors IP 68 for wiring.

Livré avec support de fixation.  
Compris des connecteurs gel rapides IP68 pour le câblage.

**Finishing**

Alluminio Anodizzato Grigio Grey Anodized Aluminium Aluminium anodisé Gris	Alluminio Anodizzato Verde Green Anodized Aluminium Aluminium anodisé Vert
Alluminio Anodizzato Nero Black Anodized Aluminium Aluminium anodisé Noir	Alluminio Anodizzato Marrone Brown Anodized Aluminium Aluminium anodisé Marron

**\* Led colour**

- N 4000K
- 3 3000K, Im -5%
- 2 2700K, Im -5%

**Completa il codice**  
sostituendo al quadrato rosso la lettera o il numero corrispondente alla temperatura colore scelta.

**Complete the code**  
by replacing the red box with the letter or number corresponding to the selected colour temperature.

**Compléter le code**  
en remplaçant le carré rouge par la lettre ou le numéro correspondant à la sélection de température couleur.

**✓ Alimentatore integrato**

Integrated driver  
Alimentation intégrée

**✗ Alimentatore escluso**

Driver not included  
Alimentation non incluse

## ACCESSORI

Accessories / Accessoires

### Braccetto Pik

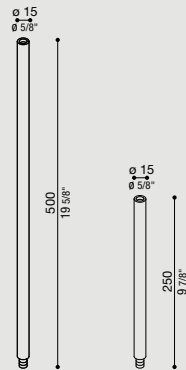

Possibilità di installazione Pik su braccetto altezza: 250 mm e 500 mm. Palo in estruso di alluminio. Elevata resistenza all'ossidazione grazie al trattamento di anodizzazione. Altezza massima 1500 mm.

#### Bracket Pik

For Pik installation on bracket, height: 250 mm and 500 mm. Designed for ground installation. Post made of extruded aluminum. Highly resistant to oxidation due to the anodizing treatment. Maximum height 1500mm.

#### Bras Pik

Possibilità d'installazione Pik sur bras, hauteur: 250 mm – 500 mm. Prévu pour installation au sol. Poteau en aluminium extrudé. Excellente résistance à l'oxydation grâce au traitement d'anodisation. Hauteur maximum 1500mm.

Braccetto Pik H 250 - Bracket Pik - Bras Pik

COL.	CODE	€
	LB1350001	34,00
	LB1350002	34,00
	LB1350003	34,00
	LB1350004	34,00

Braccetto Pik H 500 - Bracket Pik - Bras Pik

COL.	CODE	€
	LB1350005	69,00
	LB1350006	69,00
	LB1350007	69,00
	LB1350008	69,00

### Armatura da incasso CNC25

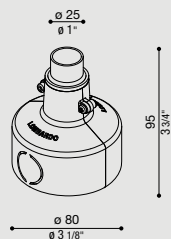

Armatura da incasso in termoplastico.

Thermoplastic recess box CNC25  
Thermoplastic recess box.

Armature à encastrer CNC25  
Armature à encastrer en matériau thermoplastique.

COL.	CODE	€
	LB1190001	5,80

### Cavo H05RN-F CNC 3x1



Cavo H05RN-F in Neoprene, sezione 3x1. Adatto ad uso esterno.

Cable type H05RN-F 3x1  
Cable type H05RN-F in Neoprene, section 3X1. Suitable for outdoor use.

Câble H05RN-F 3x1  
Câble H05RN-F en Néoprène, section 3X1. Également adapté à l'usage à l'extérieur.

5 m	10 m	15 m	20 m																
<table border="1"> <thead> <tr> <th>CODE</th> <th>€</th> </tr> </thead> <tbody> <tr> <td>LB1070054</td> <td>17,50</td> </tr> </tbody> </table>	CODE	€	LB1070054	17,50	<table border="1"> <thead> <tr> <th>CODE</th> <th>€</th> </tr> </thead> <tbody> <tr> <td>LB1070055</td> <td>31,00</td> </tr> </tbody> </table>	CODE	€	LB1070055	31,00	<table border="1"> <thead> <tr> <th>CODE</th> <th>€</th> </tr> </thead> <tbody> <tr> <td>LB1070056</td> <td>46,00</td> </tr> </tbody> </table>	CODE	€	LB1070056	46,00	<table border="1"> <thead> <tr> <th>CODE</th> <th>€</th> </tr> </thead> <tbody> <tr> <td>LB1070057</td> <td>59,50</td> </tr> </tbody> </table>	CODE	€	LB1070057	59,50
CODE	€																		
LB1070054	17,50																		
CODE	€																		
LB1070055	31,00																		
CODE	€																		
LB1070056	46,00																		
CODE	€																		
LB1070057	59,50																		

### Accessorio giardino

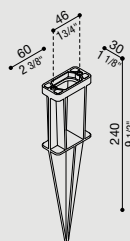

Accessorio da giardino realizzato in materiale termoplastico. Adatto per uso esterno, idoneo per installazione a terra.

Garden accessory  
Thermoplastic garden accessory. Suitable for outdoor use and ground application.

Accessoire de jardin  
Accessoire de jardin en matériau thermoplastique. Également adapté à l'usage à l'extérieur. Convient pour une utilisation au sol.

COL.	CODE	€
	LB1150035	11,50

### Morsettiera coassiale

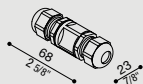

Morsettiera coassiale a 3 poli, IP68, per cavo  $\varnothing$  7/12 mm.

Coaxial Terminal block  
Coaxial 3-pole terminal block, IP68, for cable diameter 7/12 mm.

Bornier coaxial  
Bornier coaxial à 3 pôles, IP68, pour câble diam. 7/12 mm

COL.	CODE	€
	LB11293	16,00

### Morsettiera lineare a 3 vie

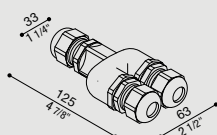

Morsettiera lineare a 3 vie a 3 poli, IP68, per cavo  $\varnothing$  7/13,5 mm.

3 way linear terminal block  
3-way 3-pole linear terminal block, IP68, for cable  $\varnothing$  7/13.5 mm.

Bornier linéaire 3 voies  
Bornier linéaire 3 voies à 3 pôles, IP68, pour câble diam. 7/13,5 mm

COL.	CODE	€
	LB11294	25,50

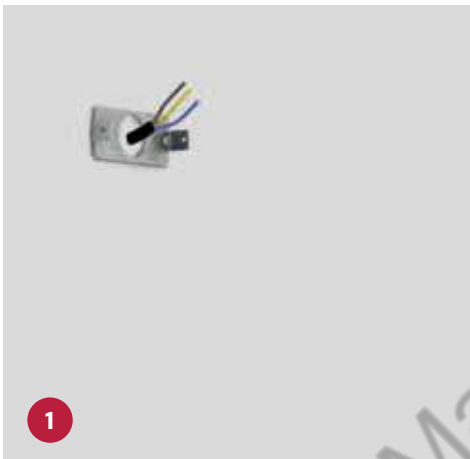

# Pik





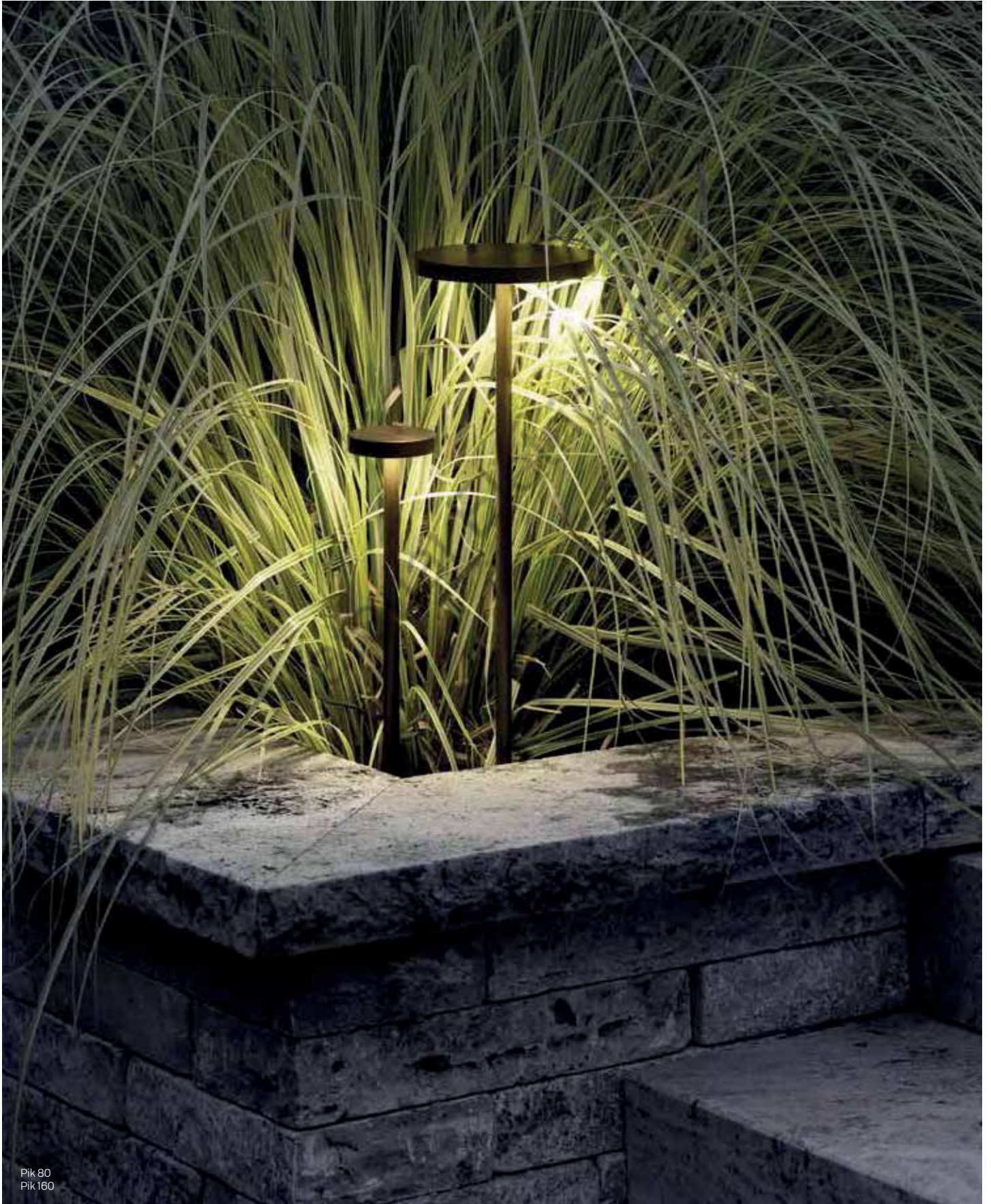

Pik 80  
Pik 160



# Pik

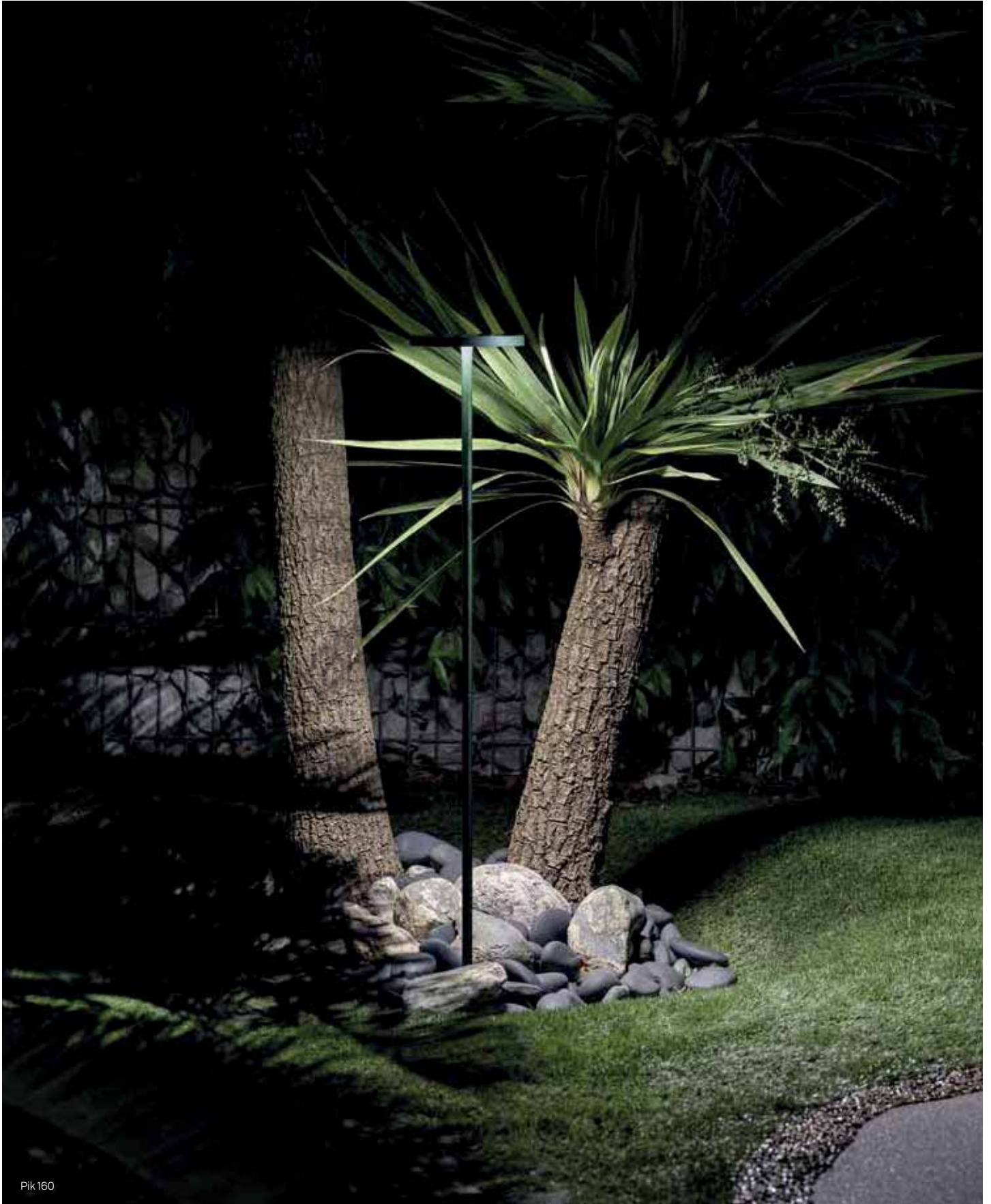



Pik 80



Pik 80 wall



Pik 80 wall

Iluminação

# Tok

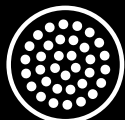

LED



outdoor

**ACCESSORI**

Accessories / Accessoires

Pag. 102



Adatto ad uso esterno.

Corpo e testa in alluminio; elevata resistenza all'ossidazione grazie al trattamento di cataforesi, e alla verniciatura con resine poliestere stabilizzata ai raggi UV.

Completo di staffa di fissaggio in tecnopolimero. Predisposto per installazione rapida su palo Ø 60 standard.

Tirafondi e minuteria per ancoraggio del palo al terreno incluso.

Diffusore in PMMA trasparente antigraffio stabilizzato ai raggi UV.

Bulloneria in acciaio A4.

Fornito con 1m di cavo H05RN-F pre-cablato.

**LED 4000K (N), 3000K (3) o 2700K (2). Alimentazione diretta 220 - 240V. Nessun rischio fotobiologico, RGO gruppo di rischio esente (EN62471).**

**ENG** Also suitable for outdoor use.

Aluminum body and top; highly resistant to oxidation thanks to cataphoresis treatment and to the UV stabilized polyester resin painting. Equipped with thermoplastic fixing bracket. Fitted for quick installation on standard Ø 60 post.

Fixing bolts and small metal parts to secure the base to the ground.

Diffuser made of transparent scratch-resistant UV stabilized PMMA.

A4 stainless steel bolts.

Provided with 1m of prewired cable H05RN-F.

**LED 4000K (N), 3000K (3) or 2700K (2). Integrated driver 220-240V.**

**No risk of photobiological damage, RGO group (EN62471).**

**FRA** Également adapté à l'usage à l'extérieur.

Corps et couverture en aluminium, haute résistance à l'oxydation grâce au traitement de cataphorèse et vernissage avec des résines polyester stabilisées aux UV.

Fourni avec étrier de fixation en technopolymère. Prédisposé pour

l'installation rapide sur poteaux standards Ø 60.

Tire-fond et visserie pour l'ancrage du poteaux au sol.

Diffuseur réalisé en PMMA transparent et anti-rayures.

Visserie en acier inox type A4.

Fourni avec 1 m de câble d'alimentation H05RN-F précâblé.

**LED 4000K (N), 3000K (3) ou 2700K (2) (blanche chaud). Alimentation intégrée 220-240. Pas de risque photobiologique, RGO groupe (EN62471).**



**Outdoor  
e waterproof**



**Alimentazione diretta**

Direct power supply  
Alimentation directe



**Cataforesi**

Cataphoresis  
Cataphorèse



**Pre-cablato**

Pre-wired  
Pré-câblé



**Anni di garanzia  
sul circuito LED**

Years warranty on LED circuit  
Ans de garantie sur la source LED



# Tok

**Tok H150**



**Tok H400**



**Tok H700**



**Tok H1000**



**Tok C 270 H150**



**Tok C 270 H400**



**Tok C 270 H700**



**Tok C 270 H1000**



**Tok C H150**



**Tok C H400**



**Tok C H700**



**Tok C H1000**



**Tok**



**Tok C 270**



**Tok C**



**Tok Q H150**



**Tok Q H400**



**Tok Q H700**



**Tok Q H1000**



**Tok QL H150**

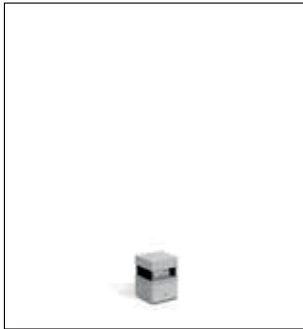

**Tok QL H400**



**Tok QL H700**



**Tok QL H1000**



**Tok Q2L H150**

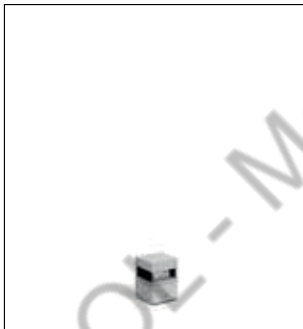

**Tok Q2L H400**



**Tok Q2L H700**



**Tok Q2L H1000**











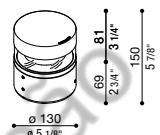

**Tok Q**

**Tok QL**

**Tok Q2L**











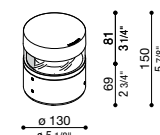

# Tok

<b>Tok H150</b>		 360°		DIFF. TRASP.			
<b>IP66 IK10 20J xx9</b> 							
LED	W	LM	REAL LM	COL.	CODE *	€	* LED COLOUR
	14	1860	650	  220-240 V		<b>LL128024</b> 	<b>184,00</b>  4000K
						<b>LL128003</b> 	<b>184,00</b>  3000K, lm -5%
						<b>LL128004</b> 	<b>184,00</b>  2700K, lm -5%
						<b>LL128005</b> 	<b>184,00</b>

Emissione luminosa 360°.

Light beam 360°.









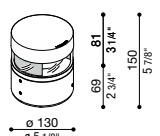

Angle d'éclairage 360°.

<b>Tok C 270 H150</b>		  270°		DIFF. TRASP.			
<b>IP66 IK10 20J xx9</b> 							
LED	W	LM	REAL LM	COL.	CODE *	€	* LED COLOUR
	9	930	240	  220-240 V		<b>LL128060</b> 	<b>184,00</b>  4000K
						<b>LL128061</b> 	<b>184,00</b>  3000K, lm -5%
						<b>LL128062</b> 	<b>184,00</b>  2700K, lm -5%
						<b>LL128063</b> 	<b>184,00</b>

Emissione luminosa 270°.

Light beam 270°.

Angle d'éclairage 270°.



<b>Tok C H150</b>		 180°		DIFF. TRASP.			
<b>IP66 IK10 20J xx9</b> 							
LED	W	LM	REAL LM	COL.	CODE *	€	* LED COLOUR
	8	930	200	  220-240 V		<b>LL128023</b> 	<b>184,00</b>  4000K
						<b>LL128000</b> 	<b>184,00</b>  3000K, lm -5%
						<b>LL128001</b> 	<b>184,00</b>  2700K, lm -5%
						<b>LL128002</b> 	<b>184,00</b>

Emissione luminosa 180°.

Light beam 180°.

Angle d'éclairage 180°.

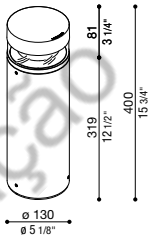





<b>Tok H400</b>				DIFF. TRASP.					
<b>IP66 IK10 20J xx9</b>		CE UK CR							
LED	W	LM	REAL LM	COL.	CODE *	€	* LED COLOUR		
	14	1860	650		LL128032□	195,50	N 4000K		
					LL128009□	195,50	3 3000K, lm -5%		
					LL128010□	195,50	2 2700K, lm -5%		
					LL128011□	195,50			

Emissione luminosa 360°.

Light beam 360°.

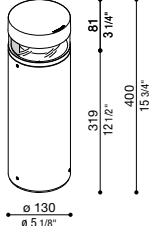

Angle d'éclairage 360°.

<b>Tok C 270 H400</b>		 		DIFF. TRASP.					
<b>IP66 IK10 20J xx9</b>		CE UK CR							
LED	W	LM	REAL LM	COL.	CODE *	€	* LED COLOUR		
	9	930	240		LL128064□	195,50	N 4000K		
					LL128065□	195,50	3 3000K, lm -5%		
					LL128066□	195,50	2 2700K, lm -5%		
					LL128067□	195,50			

Emissione luminosa 270°.

Light beam 270°.

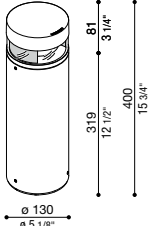
Angle d'éclairage 270°.

<b>Tok C H400</b>				DIFF. TRASP.					
<b>IP66 IK10 20J xx9</b>		CE UK CR							
LED	W	LM	REAL LM	COL.	CODE *	€	* LED COLOUR		
	8	930	200		LL128033□	195,50	N 4000K		
					LL128006□	195,50	3 3000K, lm -5%		
					LL128007□	195,50	2 2700K, lm -5%		
					LL128008□	195,50			

Emissione luminosa 180°.

Light beam 180°.

Angle d'éclairage 180°.

**Finishing**

	Bianco RAL 9010 White RAL 9010 Blanc RAL 9010		Grigio antracite RAL 7021 Grey anthracite RAL 7021 Gris anthracite RAL 7021
	Grigio High Tech RAL 9006 Grey High Tech RAL 9006 Gris High Tech RAL 9006		Corten Corten Corten

**\* Led colour**

- N 4000K
- 3 3000K, lm -5%
- 2 2700K, lm -5%

**Completa il codice**  
sostituendo al quadrato rosso la lettera o il numero corrispondente alla temperatura colore scelta.

**Complete the code**  
by replacing the red box with the letter or number corresponding to the selected colour temperature.

**Compléter le code**  
en remplaçant le carré rouge par la lettre ou le numéro correspondant à la sélection de température couleur.

**Alimentatore integrato**  
Integrated driver  
Alimentation intégrée

# Tok

## Tok H700



DIFF.  
TRASP.

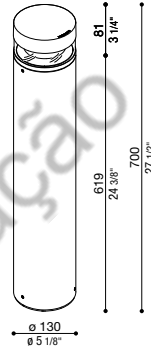

IP 66 IK 10 20J xx9 CE UK  
CA

LED	W	LM	REAL LM	COL.	CODE *	€	* LED COLOUR
	14	1860	650		LL128018□	230,50	N 4000K
					LL128015□	230,50	3 3000K, Im -5%
					LL128016□	230,50	2 2700K, Im -5%
					LL128017□	230,50	

Emissione luminosa 360°.

Light beam 360°.

Angle d'éclairage 360°.

## Tok C 270 H700



DIFF.  
TRASP.

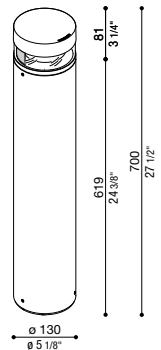

IP 66 IK 10 20J xx9 CE UK  
CA

LED	W	LM	REAL LM	COL.	CODE *	€	* LED COLOUR
	8	930			LL128068□	230,50	N 4000K
					LL128069□	230,50	3 3000K, Im -5%
					LL128070□	230,50	2 2700K, Im -5%
					LL128071□	230,50	

Emissione luminosa 270°.

Light beam 270°.

Angle d'éclairage 270°.

## Tok C H700



DIFF.  
TRASP.

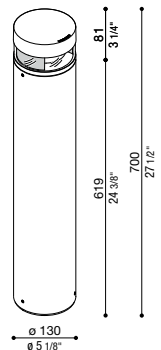

IP 66 IK 10 20J xx9 CE UK  
CA

LED	W	LM	REAL LM	COL.	CODE *	€	* LED COLOUR
	8	930	200		LL128020□	230,50	N 4000K
					LL128012□	230,50	3 3000K, Im -5%
					LL128013□	230,50	2 2700K, Im -5%
					LL128014□	230,50	

Emissione luminosa 180°.

Light beam 180°.

Angle d'éclairage 180°.

### Finishing

	Bianco RAL 9010 White RAL 9010 Blanc RAL 9010		Grigio antracite RAL 7021 Grey anthracite RAL 7021 Gris anthracite RAL 7021
	Grigio High Tech RAL 9006 Grey High Tech RAL 9006 Gris High Tech RAL 9006		Corten Corten Corten

### \* Led colour

- N 4000K
- 3 3000K, Im -5%
- 2 2700K, Im -5%

**Completa il codice**  
sostituendo al quadrato rosso la lettera o il numero corrispondente alla temperatura colore scelta.

**Complete the code**  
by replacing the red box with the letter or number corresponding to the selected colour temperature.

**Compléter le code**  
en remplaçant le carré rouge par la lettre ou le numéro correspondant à la sélection de température couleur.

**Alimentatore integrato**  
Integrated driver  
Alimentation intégrée



**Tok H1000**



DIFF. TRASP.

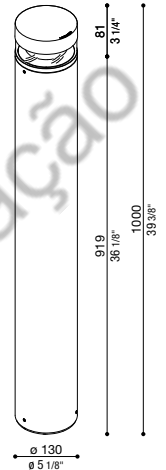

**IP 66 IK 10 20J xx9**

LED	W	LM	REAL LM	COL.	CODE *	€	* LED COLOUR
	14	1860	650	220-240 V	LL128051	265,00	4000K
					LL128052	265,00	3000K, lm -5%
					LL128053	265,00	2700K, lm -5%
					LL128054	265,00	

Emissione luminosa 360°.

Light beam 360°.

Angle d'éclairage 360°.

**Tok C 270 H1000**



DIFF. TRASP.

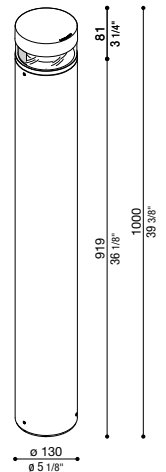

**IP 66 IK 10 20J xx9**

LED	W	LM	REAL LM	COL.	CODE *	€	* LED COLOUR
	9	930	240	220-240 V	LL128072	265,00	4000K
					LL128073	265,00	3000K, lm -5%
					LL128074	265,00	2700K, lm -5%
					LL128075	265,00	

Emissione luminosa 270°.

Light beam 270°.

Angle d'éclairage 270°.

**Tok C H1000**



DIFF. TRASP.

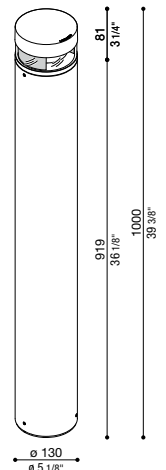

**IP 66 IK 10 20J xx9**

LED	W	LM	REAL LM	COL.	CODE *	€	* LED COLOUR
	8	930	200	220-240 V	LL128047	265,00	4000K
					LL128048	265,00	3000K, lm -5%
					LL128049	265,00	2700K, lm -5%
					LL128050	265,00	

Emissione luminosa 180°.

Light beam 180°.

Angle d'éclairage 180°.



# Tok

## Tok Q H150



DIFF.  
TRASP.

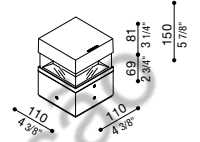

IP 66 IK 10 20J xx9 CE UK CR

LED	W	LM	REAL LM	COL.	CODE *	€	* LED COLOUR
14	1920	630	⊕ ✓ 220-240 V		LL12810W□	191,50	N 4000K
					LL12810G□	191,50	3 3000K, lm -5%
					LL12810E□	191,50	2 2700K, lm -5%
					LL12810K□	191,50	

Emissione luminosa 360°.

Light beam 360°.

Angle d'éclairage 360°.

## Tok QL H150



DIFF.  
TRASP.

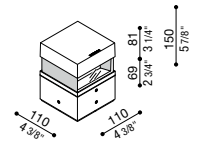

IP 66 IK 10 20J xx9 CE UK CR

LED	W	LM	REAL LM	COL.	CODE *	€	* LED COLOUR
5	480	140	⊕ ✓ 220-240 V		LL12811W□	191,50	N 4000K
					LL12811G□	191,50	3 3000K, lm -5%
					LL12811E□	191,50	2 2700K, lm -5%
					LL12811K□	191,50	

Versione Monoemissione.

Unidirectional version.

Version unidirectionnelle.

## Tok Q2L H150



DIFF.  
TRASP.

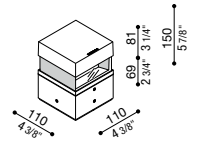

IP 66 IK 10 20J xx9 CE UK CR

LED	W	LM	REAL LM	COL.	CODE *	€	* LED COLOUR
8	960	180	⊕ ✓ 220-240 V		LL12812W□	191,50	N 4000K
					LL12812G□	191,50	3 3000K, lm -5%
					LL12812E□	191,50	2 2700K, lm -5%
					LL12812K□	191,50	

Versione Biemissione.

Bidirectional version.

Version bidirectionnelle.



**Tok Q H400**



DIFF. TRASP.

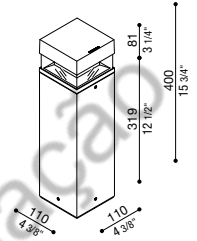

**IP 66 IK 10 20J xx9**

LED	W	LM	REAL LM	COL.	CODE *	€	* LED COLOUR
	14	1920	630		LL12813W□	203,00	N 4000K
					LL12813G□	203,00	3 3000K, Im -5%
					LL12813E□	203,00	2 2700K, Im -5%
					LL12813K□	203,00	

Emissione luminosa 360°.

Light beam 360°.

Angle d'éclairage 360°.

**Tok QL H400**



DIFF. TRASP.

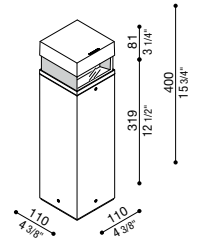

**IP 66 IK 10 20J xx9**

LED	W	LM	REAL LM	COL.	CODE *	€	* LED COLOUR
	5	480	140		LL12814W□	203,00	N 4000K
					LL12814G□	203,00	3 3000K, Im -5%
					LL12814E□	203,00	2 2700K, Im -5%
					LL12814K□	203,00	

Versione Monoemissione.

Unidirectional version.

Version unidirectionnelle.

**Tok Q2L H400**



DIFF. TRASP.

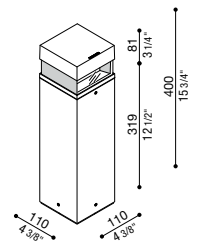

**IP 66 IK 10 20J xx9**

LED	W	LM	REAL LM	COL.	CODE *	€	* LED COLOUR
	8	960	180		LL12815W□	203,00	N 4000K
					LL12815G□	203,00	3 3000K, Im -5%
					LL12815E□	203,00	2 2700K, Im -5%
					LL12815K□	203,00	

Versione Biemissione.

Bidirectional version.

Version bidirectionnelle.

**Finishing**

	Bianco RAL 9010 White RAL 9010 Blanc RAL 9010		Grigio antracite RAL 7021 Grey anthracite RAL 7021 Gris anthracite RAL 7021
	Grigio High Tech RAL 9006 Grey High Tech RAL 9006 Gris High Tech RAL 9006		Corten Corten Corten

**\* Led colour**

- N 4000K
- 3 3000K, Im -5%
- 2 2700K, Im -5%

**Completa il codice**  
sostituendo al quadrato rosso la lettera o il numero corrispondente alla temperatura colore scelta.

**Complete the code**  
by replacing the red box with the letter or number corresponding to the selected colour temperature.

**Compléter le code**  
en remplaçant le carré rouge par la lettre ou le numéro correspondant à la sélection de température couleur.

**✓ Alimentatore integrato**  
Integrated driver  
Alimentation intégrée

# Tok

## Tok Q H700



DIFF.  
TRASP.

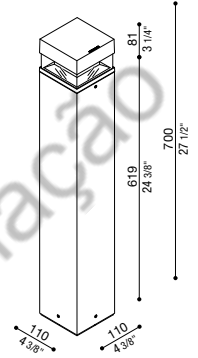

IP 66 IK 10 20J xx9 CE UK  
CA

LED	W	LM	REAL LM	COL.	CODE *	€	* LED COLOUR
	14	1920	630		LL12816W□	237,50	N 4000K
					LL12816G□	237,50	3 3000K, lm -5%
					LL12816E□	237,50	2 2700K, lm -5%
					LL12816K□	237,50	

Emissione luminosa 360°.

Light beam 360°.

Angle d'éclairage 360°.

## Tok QL H700



DIFF.  
TRASP.

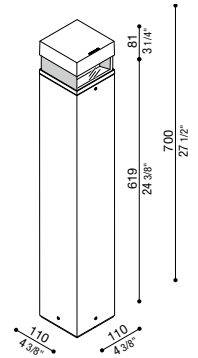

IP 66 IK 10 20J xx9 CE UK  
CA

LED	W	LM	REAL LM	COL.	CODE *	€	* LED COLOUR
	5	480	140		LL12817W□	237,50	N 4000K
					LL12817G□	237,50	3 3000K, lm -5%
					LL12817E□	237,50	2 2700K, lm -5%
					LL12817K□	237,50	

Versione Monoemissione.

Unidirectional version.

Version unidirectionnelle.

## Tok Q2L H700



DIFF.  
TRASP.

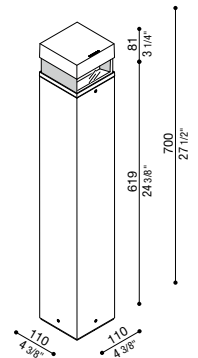

IP 66 IK 10 20J xx9 CE UK  
CA

LED	W	LM	REAL LM	COL.	CODE *	€	* LED COLOUR
	8	960	180		LL12818W□	237,50	N 4000K
					LL12818G□	237,50	3 3000K, lm -5%
					LL12818E□	237,50	2 2700K, lm -5%
					LL12818K□	237,50	

Versione Biemissione.

Bidirectional version.

Version bidirectionnelle.

### Finishing

	Bianco RAL 9010 White RAL 9010 Blanc RAL 9010		Grigio antracite RAL 7021 Grey anthracite RAL 7021 Gris anthracite RAL 7021
	Grigio High Tech RAL 9006 Grey High Tech RAL 9006 Gris High Tech RAL 9006		Corten Corten Corten

### \* Led colour

- N 4000K
- 3 3000K, lm -5%
- 2 2700K, lm -5%

**Completa il codice**  
sostituendo al quadrato rosso la lettera o il numero corrispondente alla temperatura colore scelta.

**Complete the code**  
by replacing the red box with the letter or number corresponding to the selected colour temperature.

**Compléter le code**  
en remplaçant le carré rouge par la lettre ou le numéro correspondant à la sélection de température couleur.

### ✓ Alimentatore integrato

Integrated driver  
Alimentation intégrée



**Tok Q H1000**



DIFF. TRASP.

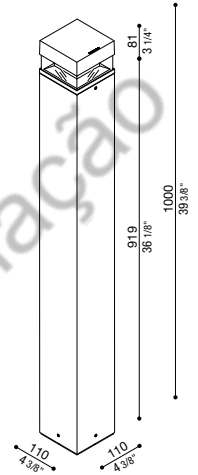

**IP66 IK 10 20J xx9 CE UK CA**

LED	W	LM	REAL LM	COL.	CODE *	€	* LED COLOUR
	14	1920	630	⊕	LL12819W□	272,50	N 4000K
				⊕	LL12819G□	272,50	3 3000K, lm -5%
				⊕	LL12819E□	272,50	2 2700K, lm -5%
				⊕	LL12819K□	272,50	

Emissione luminosa 360°.

Light beam 360°.

Angle d'éclairage 360°.

**Tok QL H1000**



DIFF. TRASP.

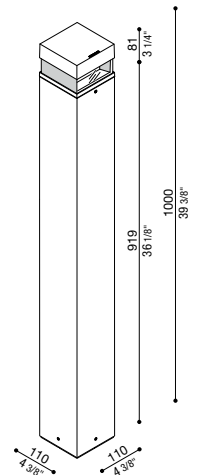

**IP66 IK 10 20J xx9 CE UK CA**

LED	W	LM	REAL LM	COL.	CODE *	€	* LED COLOUR
	5	480	140	⊕	LL12820W□	272,50	N 4000K
				⊕	LL12820G□	272,50	3 3000K, lm -5%
				⊕	LL12820E□	272,50	2 2700K, lm -5%
				⊕	LL12820K□	272,50	

Versione Monoemissione.

Unidirectional version.

Version unidirectionnelle.

**Tok Q2L H1000**



DIFF. TRASP.

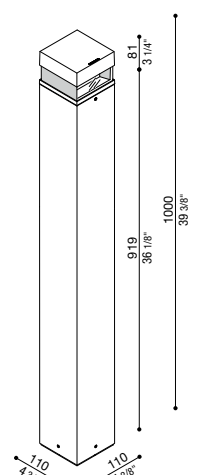

**IP66 IK 10 20J xx9 CE UK CA**

LED	W	LM	REAL LM	COL.	CODE *	€	* LED COLOUR
	8	960	180	⊕	LL12821W□	272,50	N 4000K
				⊕	LL12821G□	272,50	3 3000K, lm -5%
				⊕	LL12821E□	272,50	2 2700K, lm -5%
				⊕	LL12821K□	272,50	

Versione Biemissione.

Bidirectional version.

Version bidirectionnelle.

## ACCESSORI

Accessories / Accessoires

### Staffa Tok in acciaio

Tok steel fixing base

Base de fixation en acier pour Tok

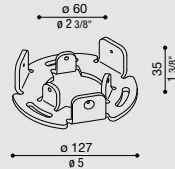

COL.	CODE	€
	<b>LB1280003</b>	<b>51,00</b>

### Staffa Tok Q in acciaio

Tok Q steel fixing base

Base de fixation en acier pour Tok Q

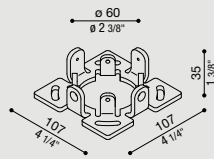

COL.	CODE	€
	<b>LB1280004</b>	<b>57,00</b>

### Morsettiere coassiale

Morsettiere coassiale a 3 poli, IP68, per cavo  $\varnothing$  7/12 mm.

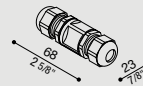

**Coaxial Terminal block**  
Coaxial 3-pole terminal block,  
IP68, for cable diameter 7/12 mm.

**Bornier coaxial**  
Bornier coaxial à 3 pôles, IP68,  
pour câble diam. 7/12 mm

COL.	CODE	€
	<b>LB11293</b>	<b>16,00</b>

### Morsettiere lineare a 3 vie

Morsettiere lineare a 3 vie a 3 poli, IP68, per cavo  $\varnothing$  7/13,5 mm.

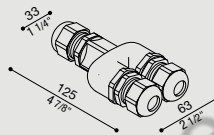

**3 way linear terminal block**  
3-way 3-pole linear terminal block,  
IP68, for cable  $\varnothing$  7/13,5 mm.

**Bornier linéaire 3 voies**  
Bornier linéaire 3 voies à 3 pôles,  
IP68, pour câble diam. 7/13,5 mm

COL.	CODE	€
	<b>LB11294</b>	<b>25,50</b>

SAPOL - Materiali Elettrici e Illuminazione



Predisposto per installazione su palo da Ø60 mm standard.  
 Suitable for installation on standard post Ø60 mm.  
 Prêdisposé pour l'installation sur Poteau standard Ø60 mm.



TOK

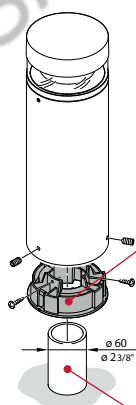

Base di fissaggio compresa.  
 Fixing base included.  
 Base de fixation incluse.

Palo da Ø60 mm standard  
 Ø60 mm standard post.  
 Standard Poteau Ø60 mm.

TOK Q

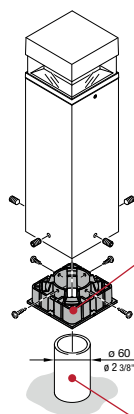

Base di fissaggio compresa.  
 Fixing base included.  
 Base de fixation incluse.

Palo da Ø60 mm standard  
 Ø60 mm standard post.  
 Standard Poteau Ø60 mm.



# Tok

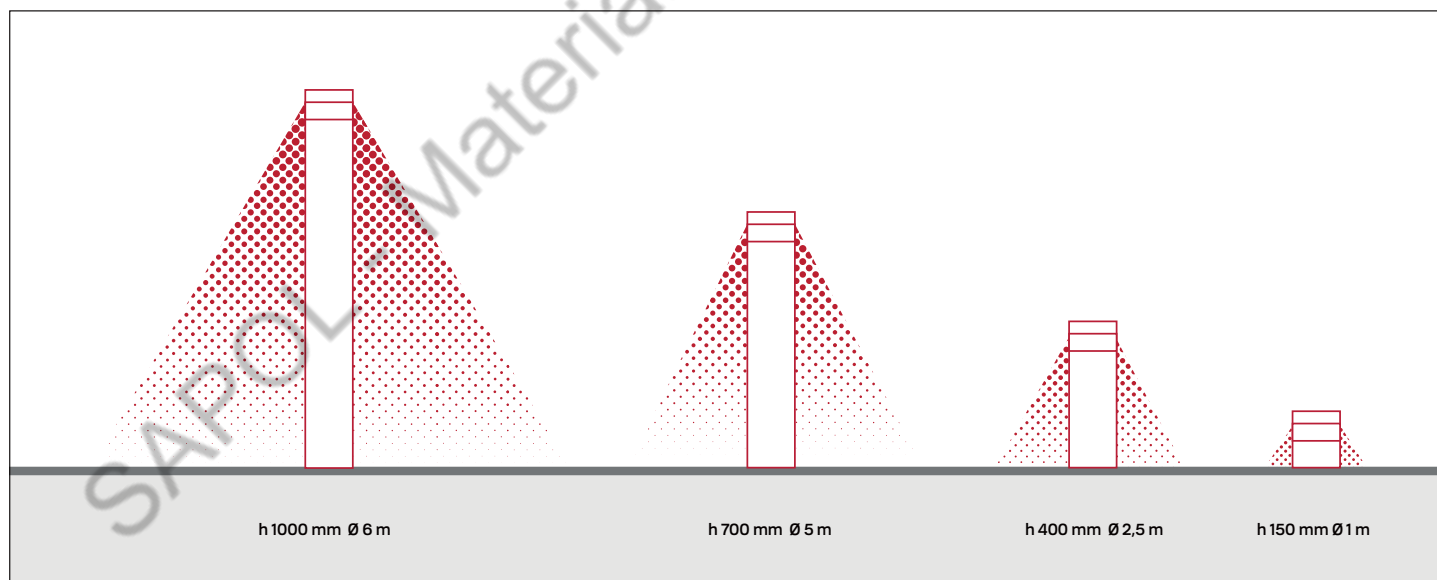
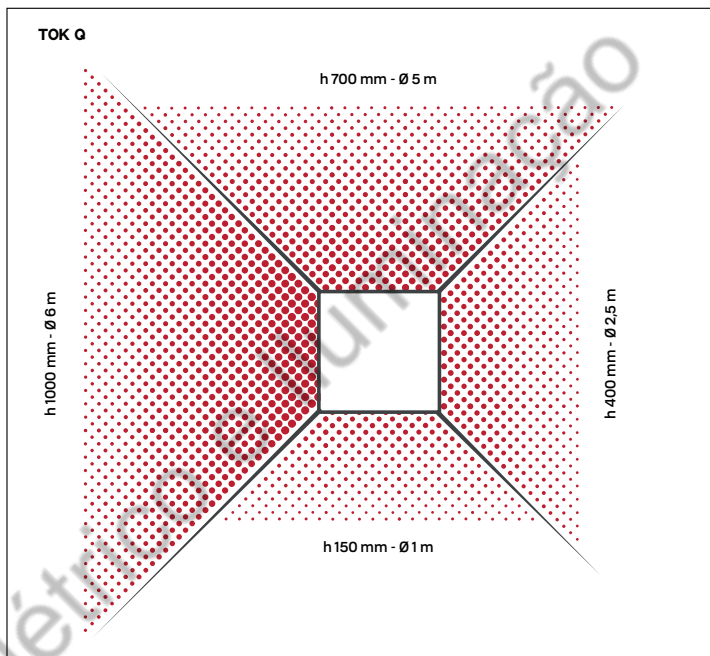
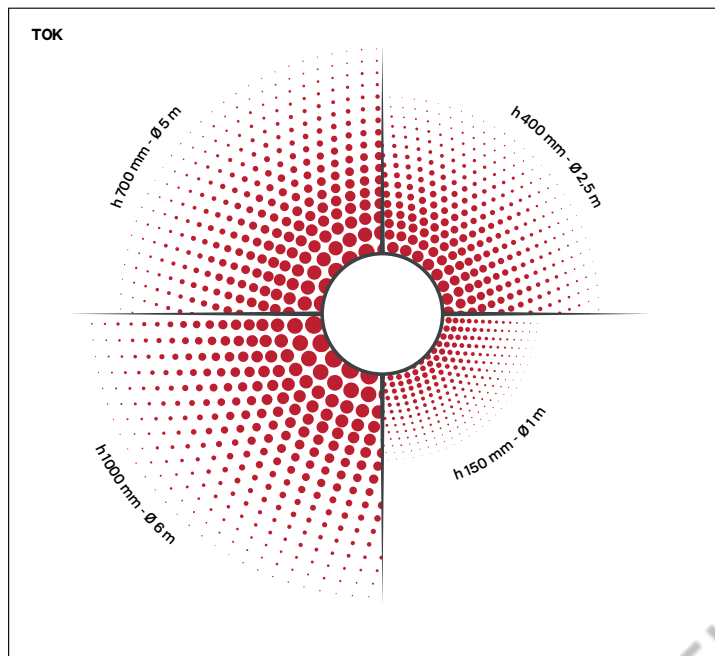

Scogliendo diverse altezze,  
varia l'area illuminata.

*By choosing different heights,  
the lit area changes.*

*En choisissant des hauteurs  
différentes, la zone éclairée  
change.*



Colori disponibili.  
Available colours.  
Couleurs disponibles.

H150

H400

H700

H1000



# Tok



Tok C 270 H150



Tok C 270 H150





Tok H150

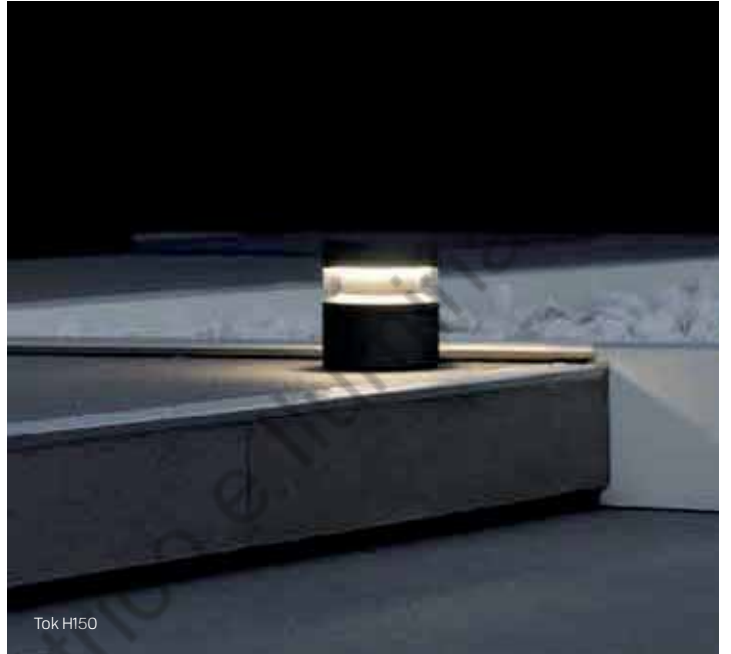

Tok H150



Tok H400

# Tok



Tok Q H150



Tok Q H150





Tok Q H400



Tok Q H700



# Flag

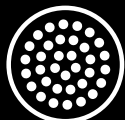

LED



outdoor

**ACCESSORI**

Accessories / Accessoires

Pag. 118



Corpo in alluminio pressofuso; elevata resistenza all'ossidazione grazie al trattamento di cataforesi e alla verniciatura con resine poliestere stabilizzata ai raggi UV. Diffusore in vetro temprato e serigrafato. Guarnizioni in silicone. Riflettore in alluminio anodizzato. Bulloneria in acciaio inox A4. Prodotto inaccessibile fornito con connettore rapido presa-spina IP68 con barriera anti condensa.

**LED 4000K (N), 3000K (3) o 2700K (2). Nessun rischio fotobiologico, RGO gruppo di rischio esente (EN62471).**

**ENG** Die-cast aluminium body; high resistance to oxidation thanks to cataphoresis treatment and UV-stabilised polyester resin coating. Screen-printed tempered glass diffuser. Silicone gaskets. Anodized aluminium reflector. A4 stainless steel nuts and bolts.

Inaccessible device supplied with quick connector plug-socket IP68 with anti-condensation barrier.

LED 4000K (N), 3000K (3) or 2700K (2). No photobiological risk, RGO risk group (EN62471).

**FRA** Corps en aluminium inéjecté; haute résistance à l'oxydation grâce au traitement de cataphorèse et à la peinture avec des résines polyester stabilisées contre les rayons UV. Diffuseur en verre trempé et sérigraphié. Joints en silicone. Réflecteur en aluminium anodisé. Boulons A4 en acier inoxydable. Produit câblé en usine fourni avec un connecteur rapide fiche-douille IP68 avec barrière anti-condensation.

LED 4000K (N), 3000K (3) ou 2700K (2). Pas de risque photobiologique, groupe de risque RGO exempt (EN62471).

**Flag 330**



**Flag 330 Post**



**Flag 330 Reg**



**Flag 330 Zero**



**Flag 200**



**Flag 200 Post**



**Flag 200 Reg**



**Flag 200 Bollard**



**Outdoor  
e waterproof**



**Alimentazione diretta**  
Direct power supply  
Alimentation directe



**Dimmerabile**  
Dimmable  
Dimmable



**Cataforesi**  
Cataphoresis  
Cataphorèse



**Anni di garanzia  
sul circuito LED**  
Years warranty on LED circuit  
Ans de garantie sur la source LED

# Flag



1 FLAG 330 POST  
FLAG 200 POST  
+ PALO STILL

2 FLAG 200 BOLLARD

3 FLAG 330  
+ PALO FLAG

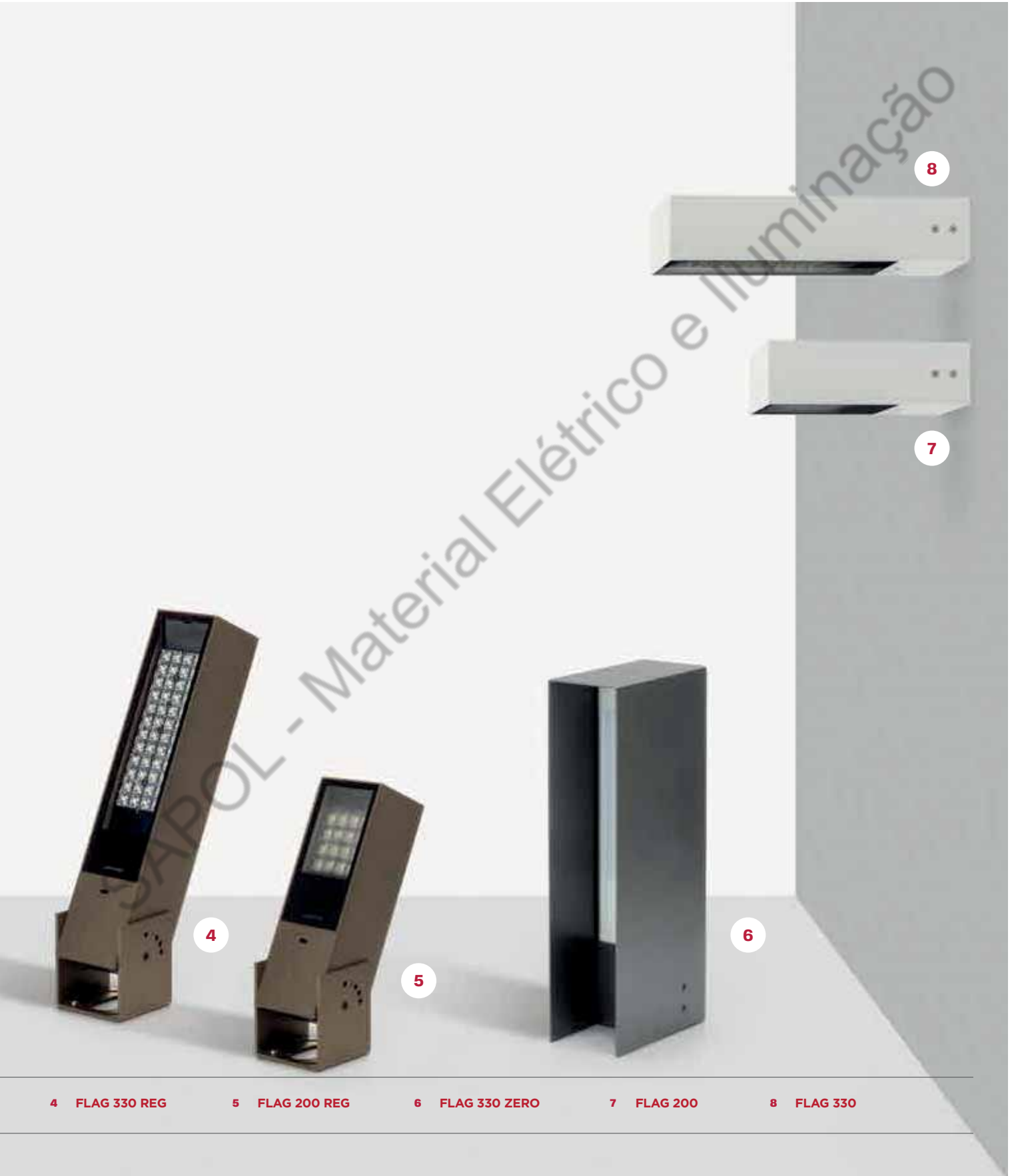

4 FLAG 330 REG

5 FLAG 200 REG

6 FLAG 330 ZERO

7 FLAG 200

8 FLAG 330

# Flag

## Flag 330

DIFF.  
VETRO

IP66 IK 07 2J xx5 CE UK  
CA

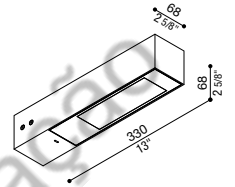

LED	W	LM	REAL LM	COL.	CODE **	€	* OPTIC	* LED COLOUR
19	2850	Max1980	☑️ 220-240 V	[ ]	LL14000W [ ]	172,50	S Spot-25° W Wide A Asymm. D Diff.	N 4000K 3 3000K, Im -5% 2 2700K, Im -5%
					LL14000G [ ]	172,50		
					LL14000E [ ]	172,50		
					LL14000K [ ]	172,50		
19	2850	Max1980	☑️ 220-240 V DALI	[ ]	LM14000W [ ]	230,50	S Spot-25° W Wide A Asymm. D Diff.	N 4000K 3 3000K, Im -5% 2 2700K, Im -5%
					LM14000G [ ]	230,50		
					LM14000E [ ]	230,50		
					LM14000K [ ]	230,50		
19	2850	Max1980	❌ 24V	[ ]	LT14000W [ ]	207,50	S Spot-25° W Wide A Asymm. D Diff.	N 4000K 3 3000K, Im -5% 2 2700K, Im -5%
					LT14000G [ ]	207,50		
					LT14000E [ ]	207,50		
					LT14000K [ ]	207,50		

## Flag 330 Post

DIFF.  
VETRO

IP66 IK 07 2J xx5 CE UK  
CA

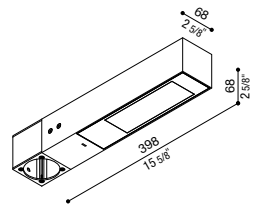

LED	W	LM	REAL LM	COL.	CODE **	€	* OPTIC	* LED COLOUR
19	2850	Max1980	☑️ 220-240 V	[ ]	LL14030W [ ]	203,00	S Spot-25° W Wide A Asymm. D Diff.	N 4000K 3 3000K, Im -5% 2 2700K, Im -5%
					LL14030G [ ]	203,00		
					LL14030E [ ]	203,00		
					LL14030K [ ]	203,00		
19	2850	Max1980	☑️ 220-240 V DALI	[ ]	LM14030W [ ]	260,50	S Spot-25° W Wide A Asymm. D Diff.	N 4000K 3 3000K, Im -5% 2 2700K, Im -5%
					LM14030G [ ]	260,50		
					LM14030E [ ]	260,50		
					LM14030K [ ]	260,50		
19	2850	Max1980	❌ 24V	[ ]	LT14030W [ ]	237,50	S Spot-25° W Wide A Asymm. D Diff.	N 4000K 3 3000K, Im -5% 2 2700K, Im -5%
					LT14030G [ ]	237,50		
					LT14030E [ ]	237,50		
					LT14030K [ ]	237,50		

Fornito con adattatore per installazione su palo standard Ø60mm.

Supplied with adapter for installation on a standard Ø60 mm post.

Fourni avec adaptateur pour installation sur poteau standard Ø60 mm.

### Finishing

	Bianco RAL 9010 White RAL 9010 Blanc RAL 9010		Grigio antracite RAL 7021 Grey anthracite RAL 7021 Gris anthracite RAL 7021
	Grigio High Tech RAL 9006 Grey High Tech RAL 9006 Gris High Tech RAL 9006		Corten Corten Corten

### \* Led colour

- N 4000K
- 3 3000K, Im -5%
- 2 2700K, Im -5%

**Completa il codice**  
sostituendo al quadrato rosso la lettera o il numero corrispondente alla temperatura colore scelta.

**Complete the code**  
by replacing the red box with the letter or number corresponding to the selected colour temperature.

**Compléter le code**  
en remplaçant le carré rouge par la lettre ou le numéro correspondant à la sélection de température couleur.

- ☑️ **Alimentatore integrato**  
Integrated driver  
Alimentation intégrée
- ❌ **Alimentatore escluso**  
Driver not included  
Alimentation non incluse





### Flag 330 Reg

DIFF. VETRO

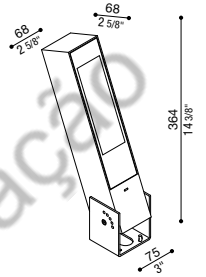

IP66 IK 07 2J xx5 CE UK CA

LED	W	LM	REAL LM	COL.	CODE **	€	* OPTIC	* LED COLOUR
19	2850	Max1980	☑️ 220-240 V	LL14010W□	184,00	S Spot-25° W Wide A Asymm. D Diff.	N 4000K 3 3000K, Im -5% 2 2700K, Im -5%	
				LL14010G□	184,00			
				LL14010E□	184,00			
				LL14010K□	184,00			
19	2850	Max1980	☑️ 220-240 V DALI	LM14010W□	242,00			
				LM14010G□	242,00			
				LM14010E□	242,00			
				LM14010K□	242,00			
19	2850	Max1980	❌ 24V	LT14010W□	219,00			
				LT14010G□	219,00			
				LT14010E□	219,00			
				LT14010K□	219,00			

Fornito con staffa a 5 step di regolazione in alluminio verniciato.

Supplied with 5-step adjustment bracket in painted aluminium.

Fourni avec un support de réglage en 5 étapes en aluminium peint.

### Flag 330 Zero

DIFF. OPAL

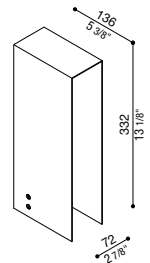

IP66 IK 07 2J xx5 CE UK CA

LED	W	LM	REAL LM	COL.	CODE *	€	* LED COLOUR
6,7	1000	180	☑️ 220-240 V	LL14020W□	195,50	N 4000K 3 3000K, Im -5% 2 2700K, Im -5%	
				LL14020G□	195,50		
				LL14020E□	195,50		
				LL14020K□	195,50		

Fornito con sistema antiabbagliamento in alluminio verniciato.

Supplied with painted aluminium anti-glare system.

Fourni avec un système anti-éblouissement en aluminium peint.

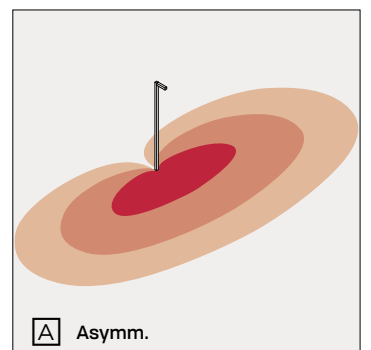
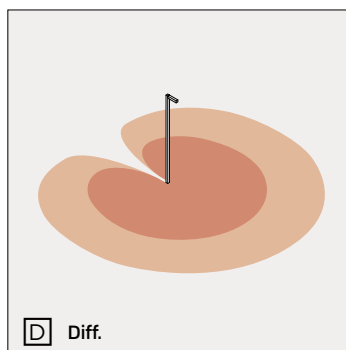
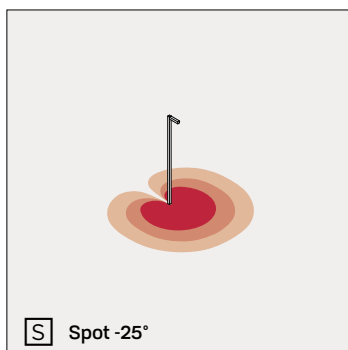
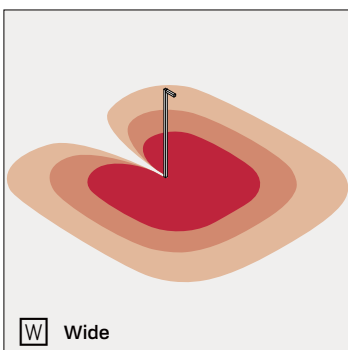

# Flag

## Flag 200

NEW

DIFF.  
VETRO

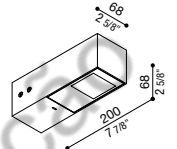

IP66 IK 07 2J xx5 CE UK CA

LED	W	LM	REAL LM	COL.	CODE **	€	* OPTIC	* LED COLOUR
10	1350	855	220-240 V	[ ] [x]	LL14001W [ ] [ ]	136,00	S Spot-25° W Wide A Asymm. D Diff.	N 4000K 3 3000K, lm -5% 2 2700K, lm -5%
					LL14001G [ ] [ ]	136,00		
					LL14001E [ ] [ ]	136,00		
					LL14001K [ ] [ ]	136,00		
10	1350	855	220-240 V DALI	[ ] [x]	LM14001W [ ] [ ]	210,00		
					LM14001G [ ] [ ]	210,00		
					LM14001E [ ] [ ]	210,00		
					LM14001K [ ] [ ]	210,00		
10	1350	855	24V	[ ] [x]	LT14001W [ ] [ ]	155,00		
					LT14001G [ ] [ ]	155,00		
					LT14001E [ ] [ ]	155,00		
					LT14001K [ ] [ ]	155,00		

## Flag 200 Post

NEW

DIFF.  
VETRO

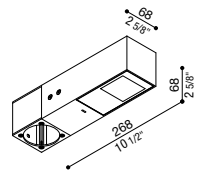

IP66 IK 07 2J xx5 CE UK CA

LED	W	LM	REAL LM	COL.	CODE **	€	* OPTIC	* LED COLOUR
10	1350	855	220-240 V	[ ] [x]	LL14031W [ ] [ ]	167,50	S Spot-25° W Wide A Asymm. D Diff.	N 4000K 3 3000K, lm -5% 2 2700K, lm -5%
					LL14031G [ ] [ ]	167,50		
					LL14031E [ ] [ ]	167,50		
					LL14031K [ ] [ ]	167,50		
10	1350	855	220-240 V DALI	[ ] [x]	LM14031W [ ] [ ]	241,50		
					LM14031G [ ] [ ]	241,50		
					LM14031E [ ] [ ]	241,50		
					LM14031K [ ] [ ]	241,50		
10	1350	855	24V	[ ] [x]	LT14031W [ ] [ ]	186,50		
					LT14031G [ ] [ ]	186,50		
					LT14031E [ ] [ ]	186,50		
					LT14031K [ ] [ ]	186,50		

Fornito con adattatore per installazione su palo standard Ø60mm.

Supplied with adapter for installation on a standard Ø60 mm post.

Fourni avec adaptateur pour installation sur poteau standard Ø60 mm.



### Flag 200 Reg



DIFF. VETRO

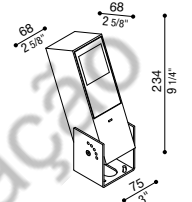

IP66 IK 07 2J xx5 CE UK CA

LED	W	LM	REAL LM	COL.	CODE **	€	* OPTIC	* LED COLOUR
10	1350	855	220-240 V	LL14011W	146,00	S Spot-25° W Wide A Asymm. D Diff.	N 4000K 3 3000K, Im -5% 2 2700K, Im -5%	
				LL14011G	146,00			
				LL14011E	146,00			
				LL14011K	146,00			
10	1350	855	220-240 V DALI	LM14011W	220,00			
				LM14011G	220,00			
				LM14011E	220,00			
				LM14011K	220,00			
10	1350	855	24V	LT14011W	165,00			
				LT14011G	165,00			
				LT14011E	165,00			
				LT14011K	165,00			

Fornito con staffa a 5 step di regolazione in alluminio verniciato.

Supplied with 5-step adjustment bracket in painted aluminium.

Fourni avec un support de réglage en 5 étapes en aluminium peint.

### Flag 200 Bollard



DIFF. VETRO

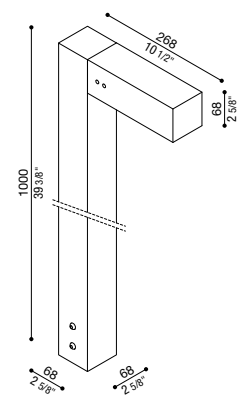

IP66 IK 07 2J xx5 CE UK CA

LED	W	LM	REAL LM	COL.	CODE **	€	* OPTIC	* LED COLOUR
10	1350	855	220-240 V	LL14021W	226,00	S Spot-25° W Wide A Asymm. D Diff.	N 4000K 3 3000K, Im -5% 2 2700K, Im -5%	
				LL14021G	226,00			
				LL14021E	226,00			
				LL14021K	226,00			
10	1350	855	220-240 V DALI	LM14021W	300,00			
				LM14021G	300,00			
				LM14021E	300,00			
				LM14021K	300,00			
10	1350	855	24V	LT14021W	245,00			
				LT14021G	245,00			
				LT14021E	245,00			
				LT14021K	245,00			

Palo H1000 e staffa di fissaggio inclusi.

H1000 pole and fixing base included.

Poteau H1000 et base de fixation inclus.

#### Finishing

	Bianco RAL 9010 White RAL 9010 Blanc RAL 9010		Grigio antracite RAL 7021 Grey anthracite RAL 7021 Gris anthracite RAL 7021
	Grigio High Tech RAL 9006 Grey High Tech RAL 9006 Gris High Tech RAL 9006		Corten Corten Corten

#### \* Led colour

- N 4000K
- 3 3000K, Im -5%
- 2 2700K, Im -5%

**Completa il codice** sostituendo al quadrato rosso la lettera o il numero corrispondente alla temperatura colore scelta.

**Complete the code** by replacing the red box with the letter or number corresponding to the selected colour temperature.

**Compléter le code** en remplaçant le carré rouge par la lettre ou le numéro correspondant à la sélection de température couleur.

#### ✓ Alimentatore integrato

Integrated driver

Alimentation intégrée

#### ✗ Alimentatore escluso

Driver not included

Alimentation non incluse

# Flag

## ACCESSORI

Accessories / Accessoires

### Adattatore palo Still Ø 60 Flag

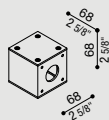

Adattatore per installazione Flag su palo standard Ø60 mm in alluminio verniciato.

**Flag adapter for Still Post Ø 60**  
Flag adapter for installation on a standard Ø60 mm post.

**Adaptateur poteau Still Ø60 Flag**  
Adaptateur pour installation Flag sur poteau standard Ø60 mm.

COL.	CODE	€
	LB140000W	33,00
	LB140000G	33,00
	LB140000E	33,00
	LB140000K	33,00

### Palo Flag

Palo in alluminio estruso verniciato H 4000 mm e H 3000 mm (interrato H 500) completo di coperchi amovibili. Predisposto per l'installazione di 1 o 2 Flag.

#### Flag Post

Painted extruded aluminium pole H 4000 mm and H 3000 mm (underground H 500) complete with removable covers. Suitable for the installation of 1 or 2 Flag.

#### Flag Poteau

Poteau en aluminium extrudé peint H 4000 mm et H 3000 mm. Convient pour l'installation de 1 ou 2 Flag.

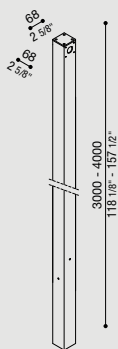

#### H 3000 mm

COL.	CODE	€
	LB140001W	348,50
	LB140001G	348,50
	LB140001E	348,50
	LB140001K	348,50

#### H 4000 mm

COL.	CODE	€
	LB140002W	421,00
	LB140002G	421,00
	LB140002E	421,00
	LB140002K	421,00



### Palo Flag con staffa

Palo in alluminio estruso verniciato H 4000 mm e H 3000 mm con staffa di fissaggio a terra in acciaio completo di coperchi amovibili (da asportare nel caso si applichino apparecchi). Predisposto per l'installazione di 1 o 2 Flag.

#### Flag Post with fixing base

Painted extruded aluminium pole H 4000 mm and H 3000 mm with fixing base complete with removable covers (to be removed to accommodate the light fixtures). Suitable for the installation of 1 or 2 Flag.

#### Flag poteau avec base de fixation

Poteau en aluminium extrudé peint H 4000 mm et H 3000 mm avec base de fixation et couvercles amovibles (à retirer pour appliquer les appareils). Convient pour l'installation de 1 ou 2 Flag.

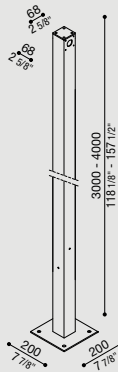

Palo Flag con staffa H3000

COL.	CODE	€
	LB1400K1W	504,50
	LB1400K1G	504,50
	LB1400K1E	504,50
	LB1400K1K	504,50

Palo Flag con staffa H4000

COL.	CODE	€
	LB1400K2W	577,00
	LB1400K2G	577,00
	LB1400K2E	577,00
	LB1400K2K	577,00

### Still

Palo diametro 60 mm in Bayblend senza basamento. Possibilità di installazione con o senza basamento. Anima interno palo in acciaio zincato per altezze da 2000 mm.

#### Still

60 mm Bayblend pole without base. Possibility of installation with or without base. Galvanized steel inner pole from H 2000 mm.

#### Still

Poteau de 60 mm en Bayblend sans socle. Possibilité d'installation avec ou sans socle. Noyau interne en acier galvanisé pour poteau à partir de h. 2000 mm.

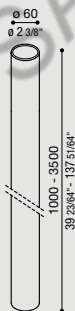

#### H 160 mm

COL.	CODE	€
	LB11033	10,50
	LB1103G	34,50
	LB1103E	34,50
	LB1103K	34,50
	LB11031	34,50

#### H 1000 mm

COL.	CODE	€
	LB1100012	13,00
	LB110001G	42,50
	LB110001E	42,50
	LB110001K	42,50
	LB110001W	42,50

#### H 2000 mm

COL.	CODE	€
	LB1100032	36,50
	LB110003G	92,00
	LB110003E	92,00
	LB110003K	92,00
	LB1100031	92,00

#### H 3000 mm

COL.	CODE	€
	LB1100052	52,00
	LB110005G	135,00
	LB110005E	135,00
	LB110005K	135,00
	LB1100051	135,00

#### H 500 mm

COL.	CODE	€
	LB11112	12,00
	LB1111G	38,50
	LB1111E	38,50
	LB1111K	38,50
	LB11111	38,50

#### H 1500 mm

COL.	CODE	€
	LB1100022	20,00
	LB110002G	63,50
	LB110002E	63,50
	LB110002K	63,50
	LB1100021	63,50

#### H 2500 mm

COL.	CODE	€
	LB1100042	47,00
	LB110004G	114,00
	LB110004E	114,00
	LB110004K	114,00
	LB1100041	114,00

#### H 3500 mm

COL.	CODE	€
	LB1100062	62,50
	LB110006G	156,50
	LB110006E	156,50
	LB110006K	156,50
	LB1100061	156,50



Predisposto per installazione su palo da Ø60 mm standard.  
 Suitable for installation on standard post Ø60 mm.  
 Prédéposé pour l'installation sur Poteau standard Ø60 mm.

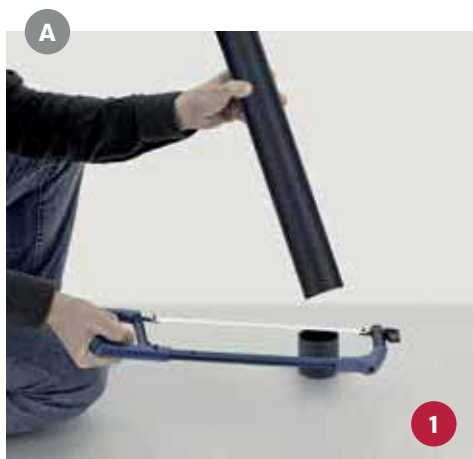

Montaggio con supporto standard.  
 Mounting with standard support.  
 Montage avec support standard.

Disponibile adattatore per installazione su palo Ø60 standard.  
 Adapter for installation on standard Ø60 pole available.  
 Adaptateur disponible pour installation sur poteau standard Ø60.



Montaggio con supporto regolabile.  
 Mounting with adjustable bracket.  
 Montage avec support réglable.







Fasci luminosi su palo Flag da 3 metri.  
Light beams on 3-metre Flag pole.  
Faisceaux lumineux sur un poteau Flag de 3 mètres.

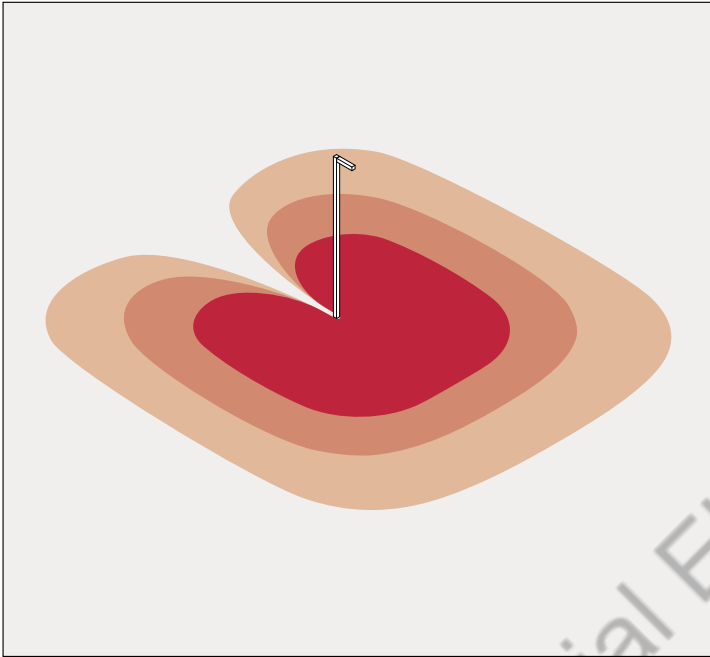

**W** Wide

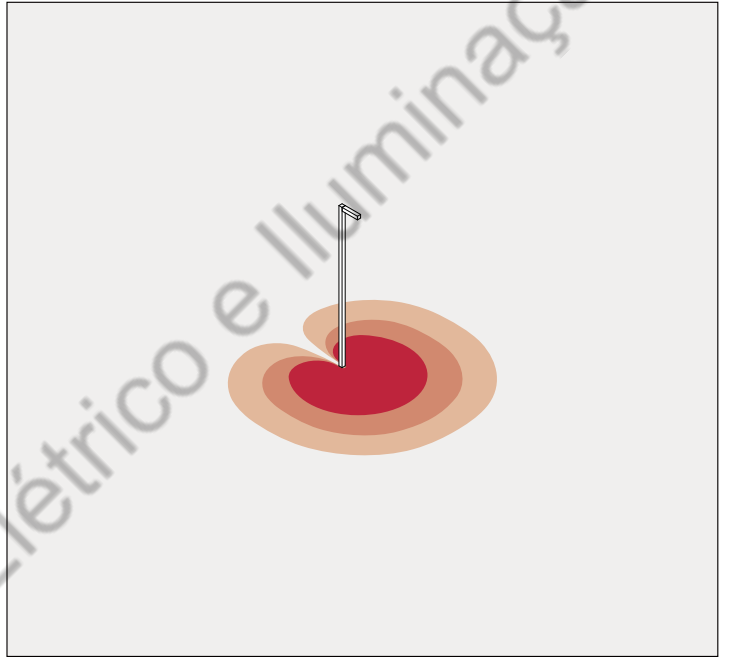

**S** Spot -25°

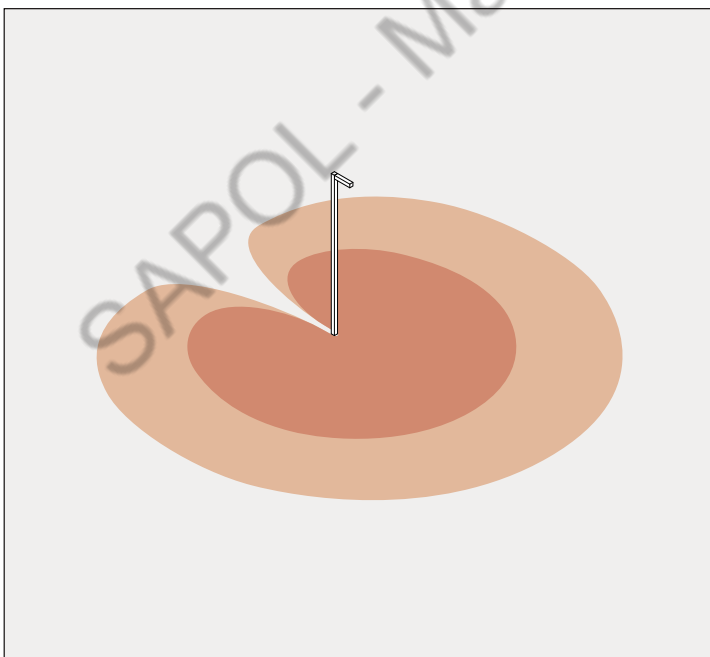

**D** Diff.

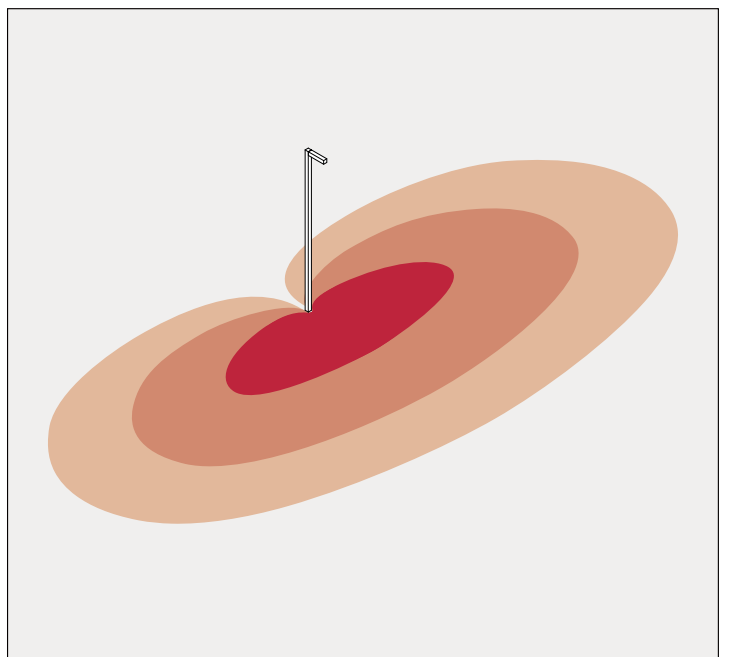

**A** Asymm.

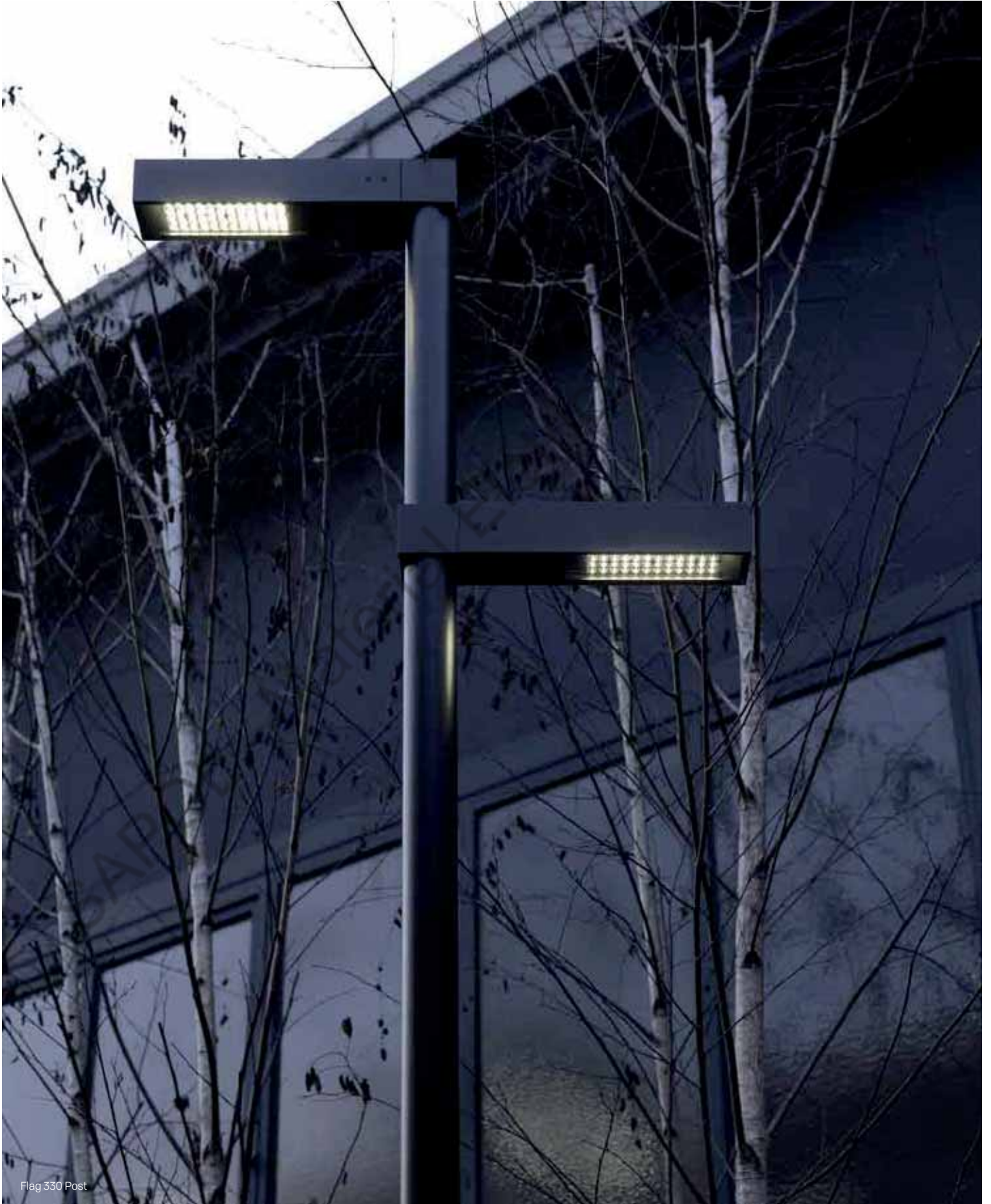

Flag 330 Post

# Flag





Flag 330



Flag 330



# Flag

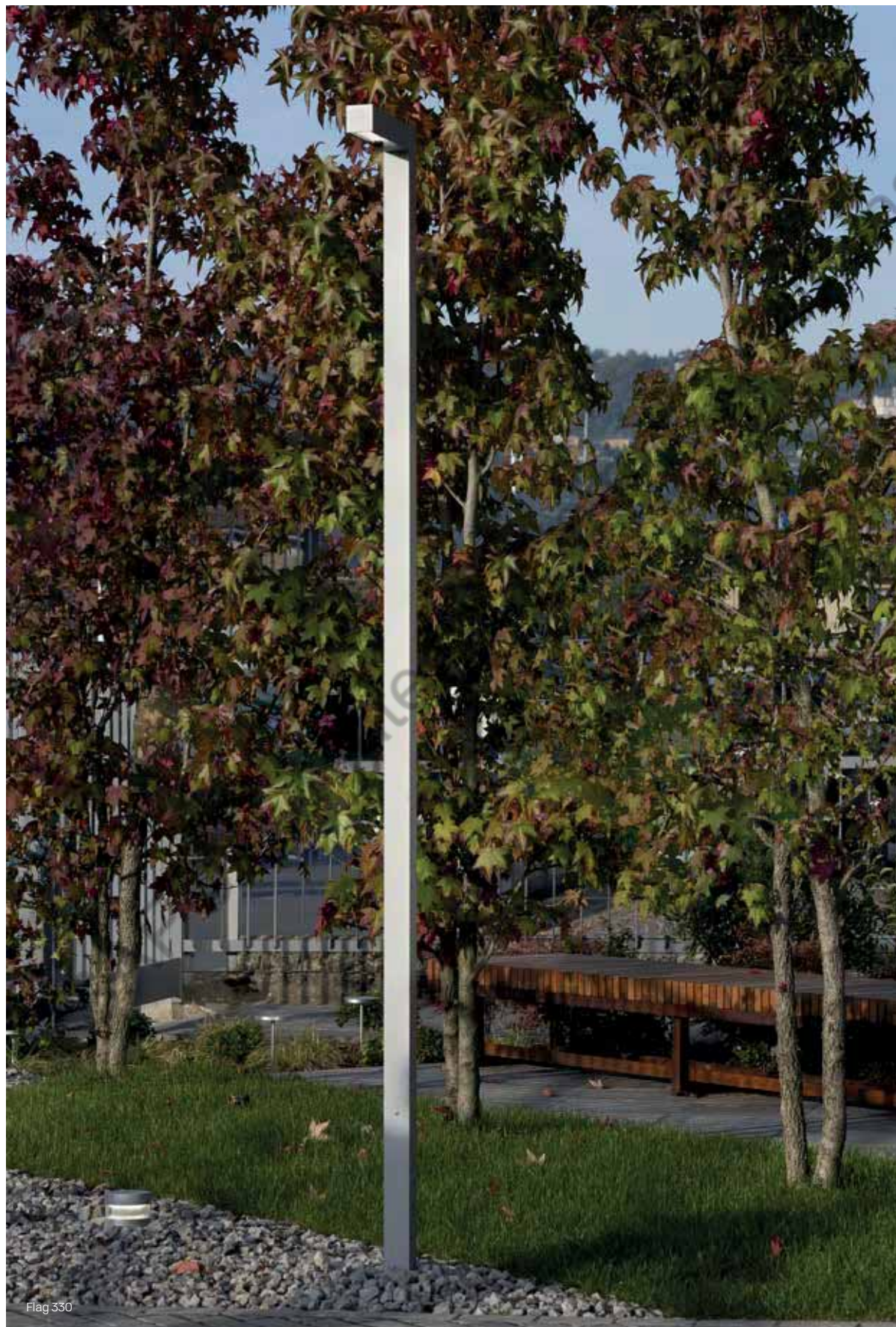



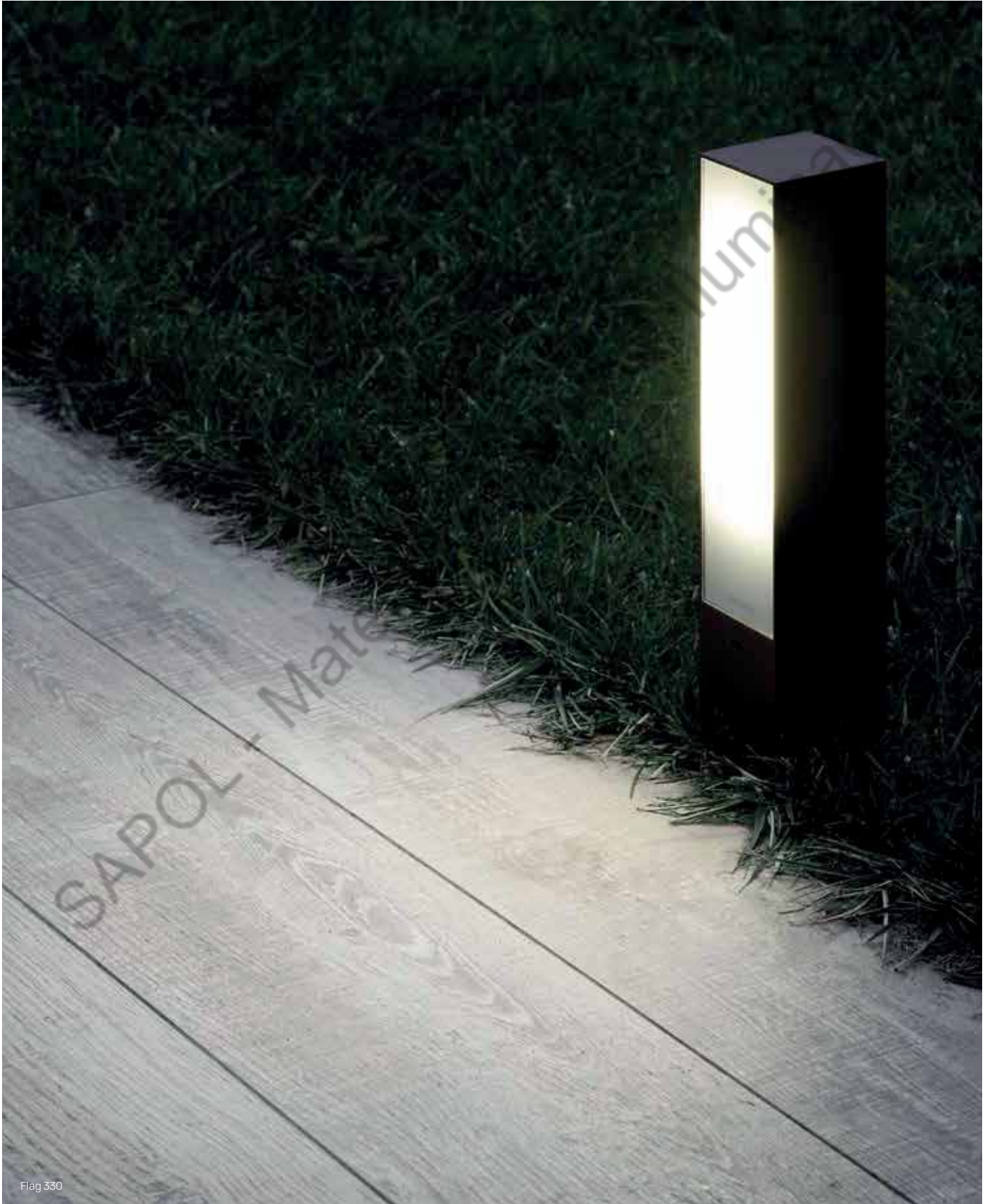

Flag 330

# Flag



Flag 330 Reg



Flag 330 Zero



Flag 200



Flag 200 Bollard



Flag 200 Bollard



# Line

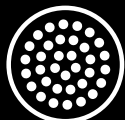

LED



outdoor

**ACCESSORI**

Accessories / Accessoires

Pag. 132



Adatto ad uso esterno.

Driver 220 - 240V integrato e Led di ultima generazione con potenze fino a 11W.

LINE, LINE DOWN e LINE 220 corpo e coperchio in alluminio primario pressofuso. Elevata resistenza all'ossidazione grazie al trattamento di passivazione a base di zirconio e alla verniciatura con resine poliestere stabilizzata ai raggi UV.

LINE 330 base e tappo in Policarbonato nero, ottenuto da stampaggio ad iniezione. Diffusore in Policarbonato ottico ad alto spessore con finitura PoliGLASS, tramite stampaggio ad iniezione proprio e successive rifiniture manuali.

Guarnizioni in silicone per il mantenimento del grado IP66. Bulloneria in acciaio inox A4. Predisposto per installazione rapida in pali Ø60 standard, tramite molle in acciaio inox ad espansione. Predisposizione per viti di sicurezza.

**LED 4000K (N), 3000K (3) o 2700K (2). Alimentazione diretta 220-240V.**

**Nessun rischio fotobiologico, RGO gruppo di rischio esente (EN62471).**

**ENG** Suitable for indoor and outdoor use.

Integrated driver 220 - 240V and the latest generation of Led with ratings of up to 11W.

LINE, LINE DOWN e LINE 220 body and cover made of die-cast aluminium primary alloy; highly resistant to oxidization thanks to the zirconium-based passivation treatment and UV stabilized polyester resin coating.

LINE 330 upper black polycarbonate cap, injection moulded in-house.

Diffuser made of very thick optical polycarbonate, poliGLASS finish, injection moulded and subsequent manual finishing.

Silicone gaskets IP66. A4 stainless steel nuts and bolts. Provision for safety screws. Suitable for quick installation in standard posts Ø60 by means of stainless steel springs.

**LED 4000K (N), 3000K (3) or 2700K (2). Integral ballast 220-240V.**

**No risk of photobiological damage, RGO group (EN62471).**

**FRA** Egalement adapté à l'usage à l'extérieur.

Alimentation intégrée 220 - 240V et Led de dernière génération avec puissances jusqu'à 11W. LINE, LINE DOWN e LINE 220 corps et couverture en aluminium primaire injecté; haute résistance à l'oxydation grâce au traitement de passivation à base de zirconium et laquage poudre à base de résines polyester, fixées au rayon UV.

LINE 330 bouchon supérieur en Polycarbonate noir, s'obtient du moulage à injection propre suivi de finitions manuelles. Diffuseur réalisé en polycarbonate, d'une épaisseur optique élevée, effect PoliGLASS, par moulage par injection et finitions manuelles successives.

Jointes en silicone pour maintenir degré IP66. Visserie en acier inox type A4. Prévu pour vis de sécurité. Predisposé pour l'installation rapide sur poteaux standards Ø60 à l'aide de ressorts à lames en inox.

**LED 4000K (N), 3000K (3) ou 2700K (2) (blanche chaud).**

**Alimentation intégrée 220-240. Pas de risque photobiologique, RGO groupe (EN62471).**

**Line**



**Line Down**



**Line 220**



**Line 220 Zero**



**Line 330**



**Outdoor  
e waterproof**



**Alimentazione diretta**

Direct power supply  
Alimentation directe







**Anni di garanzia  
sul circuito LED**

Years warranty on LED circuit  
Ans de garantie sur la source LED

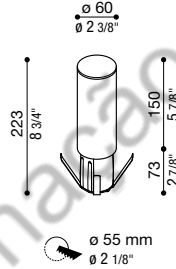





# Line

<b>Line</b>				<b>DIFF. POLIGLASS</b>									
<b>IP 66 IK 08 5J xx7</b> 													
LED	W	LM	REAL LM	COL.	CODE *	€	* LED COLOUR						
	6,5	700	604		LL113000 	104,00	<table border="1"> <tr><td>N</td><td>4000K</td></tr> <tr><td>3</td><td>3000K, lm -5%</td></tr> <tr><td>2</td><td>2700K, lm -5%</td></tr> </table>	N	4000K	3	3000K, lm -5%	2	2700K, lm -5%
N	4000K												
3	3000K, lm -5%												
2	2700K, lm -5%												

Versione a luce diretta.

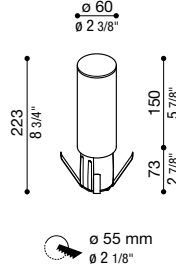
Direct light version.











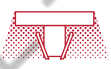
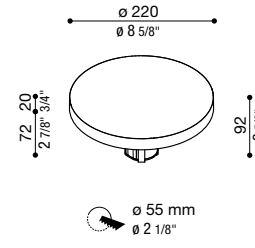



Eclairage directe.

<b>Line Down</b>				<b>DIFF. POLIGLASS</b>									
<b>IP 66 IK 08 5J xx7</b> 													
LED	W	LM	REAL LM	COL.	CODE *	€	* LED COLOUR						
	6	620	431		LL113001 	121,00	<table border="1"> <tr><td>N</td><td>4000K</td></tr> <tr><td>3</td><td>3000K, lm -5%</td></tr> <tr><td>2</td><td>2700K, lm -5%</td></tr> </table>	N	4000K	3	3000K, lm -5%	2	2700K, lm -5%
N	4000K												
3	3000K, lm -5%												
2	2700K, lm -5%												

Versione con sorgente luminosa direzionata verso il basso. Ideale per l'illuminazione di percorsi e camminamenti ed in contesti che necessitano un ridotto valore di abbagliamento.

Version with a light source directed downwards. Ideal for illuminating paths and walkways and in locations that require a reduced amount of glare.

Faisceau dirigé vers le bas ; idéal en balisage pour éclairer les chemins ou allées et éviter les éblouissements.

<b>Line 220</b>				<b>DIFF. POLIGLASS</b>																
<b>IP 66 IK 08 5J xx7</b> 																				
LED	W	LM	REAL LM	COL.	CODE *	€	* LED COLOUR													
	11	1350	910		<table border="1"> <tr><td>LL113100 </td><td>116,00</td></tr> <tr><td>LL113101 </td><td>116,00</td></tr> <tr><td>LL113102 </td><td>116,00</td></tr> <tr><td>LL113103 </td><td>116,00</td></tr> </table>	LL113100 	116,00	LL113101 	116,00	LL113102 	116,00	LL113103 	116,00	<table border="1"> <tr><td>N</td><td>4000K</td></tr> <tr><td>3</td><td>3000K, lm -5%</td></tr> <tr><td>2</td><td>2700K, lm -5%</td></tr> </table>	N	4000K	3	3000K, lm -5%	2	2700K, lm -5%
LL113100 	116,00																			
LL113101 	116,00																			
LL113102 	116,00																			
LL113103 	116,00																			
N	4000K																			
3	3000K, lm -5%																			
2	2700K, lm -5%																			

Tappo superiore in Policarbonato nero, ottenuto da stampaggio ad iniezione. Diffusore in Policarbonato tripla stabilizzazione ai raggi UV, ad alto spessore con finitura poliGLASS, ottenuto da stampaggio. Versione con sorgente luminosa direzionata verso il basso. Ideale per l'illuminazione di percorsi e camminamenti ed in contesti che necessitano di un ridotto valore di abbagliamento.

Upper black polycarbonate cap, injection moulded in-house with subsequent manual finishing. Very thick polycarbonate diffuser, injection moulded in-house with subsequent manual finishing with triple UV stabilization and polyGLASS finish. Version with lighting source directed downwards. Ideal for lighting paths and walkways in settings requiring reduced glare.

Bouchon supérieur en Polycarbonate noir, s'obtient du moulage à injection propre suivi de finitions manuelles. Diffusor en Polycarbonate triple stabilisation aux rayons UV, très épais avec finition poliGLASS, s'obtient du moulage à injection propre suivi de finitions manuelles. Version avec source lumineuse dirigée vers le bas. Adapté à l'éclairage de parcours et passages dans un contexte demandant un éblouissement faible.



## Line 220 Zero



DIFF. POLIGLASS

IP 66 IK 08 5J xx7 CE UK CRA

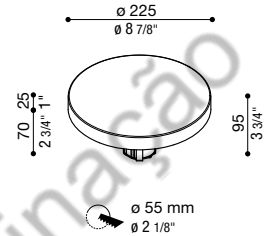

LED	W	LM	REAL LM	COL.	CODE *	€	* LED COLOUR
11	1350	632	⊕ 220-240 V	Black	LL113112□	163,00	N 4000K
				Grey	LL113113□	163,00	3 3000K, Im -5%
				Dark Grey	LL113114□	163,00	2 2700K, Im -5%
				Brown	LL113115□	163,00	

Apparecchio cut-off conforme alle più restrittive norme regionali contro l'inquinamento luminoso.

CUT-OFF version anti-light pollution.

Version CUT-OFF anti pollution lumineuse.

## Line 330



DIFF. POLIGLASS

IP 66 IK 10 20J xx9 CE UK CRA

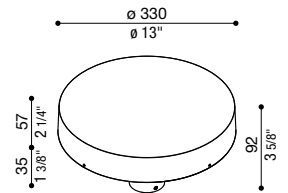

LED	W	LM	REAL LM	COL.	CODE *	€	* LED COLOUR
25	3000	2144	⊕ 220-240 V	Black	LL113200□	183,50	N 4000K
				Grey	LL113201□	183,50	3 3000K, Im -5%
				Dark Grey	LL113202□	183,50	2 2700K, Im -5%
				Brown	LL113203□	183,50	
25	3000	2144	⊕ 220-240 V	Black	LL113205□	232,50	
				Grey	LL113206□	232,50	
				Dark Grey	LL113207□	232,50	
				Brown	LL113208□	232,50	

Tappo superiore in Policarbonato nero, ottenuto da stampaggio ad iniezione. Diffusore in Policarbonato tripla stabilizzazione ai raggi UV, ad alto spessore con finitura poliGLASS, ottenuto da stampaggio. Versione con sorgente luminosa direzionata verso il basso. Installazione su palo tramite viti autofilettanti. Fornito con 1 m di cavo di alimentazione H05RN-F pre-cablato.

Upper black polycarbonate cap, injection moulded in-house with subsequent manual finishing. Very thick polycarbonate diffuser, injection moulded in-house with subsequent manual finishing with triple UV stabilization and polyGLASS finish. Version with lighting source directed downwards. Installed on post by means of self tapping screw. Provided with 1m of prewired power cable H05RN-F.

Bouchon supérieur en Polycarbonate noir, s'obtient du moulage à injection propre suivi de finitions manuelles. Diffuseur en Polycarbonate triple stabilisation aux rayons UV, très épais avec finition poliGLASS, s'obtient du moulage à injection propre suivi de finitions manuelles. Version avec source lumineuse dirigée vers le bas. Installation sur poteau avec vis autoperceuses. Fourni avec 1m de câble d'alimentation H05RN-F pré-cablé.



### Disponibile versione corridor function.

Funzione a risparmio energetico che permette di configurare un profilo di illuminazione su due livelli. Il prodotto funziona costantemente ad un'intensità luminosa ridotta, raggiungendo la massima efficienza al passaggio, tramite un sensore di prossimità.

### Available version corridor function.

Energy saving function that allows 2 different levels of lighting configuration. The product constantly works at a reduced intensity and thanks to a movement detector, luminous intensity is automatically increased at passage.

### Disponibile version corridor function.

Fonction d'économie d'énergie qui vous permet de configurer un profil d'éclairage sur deux niveaux. Le produit fonctionne constamment à une intensité lumineuse réduite, atteignant une efficacité maximale au passage, grâce à un détecteur de proximité.

### Finishing

	Nero da stampaggio Black Noir moulé		Grigio antracite RAL 7021 Grey anthracite RAL 7021 Gris anthracite RAL 7021
	Grigio High Tech RAL 9006 Grey High Tech RAL 9006 Gris High Tech RAL 9006		Corten Corten Corten

### \* Led colour

	4000K
	3000K, Im -5%
	2700K, Im -5%

**Completa il codice** sostituendo al quadrato rosso la lettera o il numero corrispondente alla temperatura colore scelta.

**Complete the code** by replacing the red box with the letter or number corresponding to the selected colour temperature.

**Compléter le code** en remplaçant le carré rouge par la lettre ou le numéro correspondant à la sélection de température couleur.

### Alimentatore integrato

Integrated driver

Alimentation intégrée

# Line

## ACCESSORI

Accessories / Accessoires

### Basamento Palo Still Ø170 mm



Basamento in nylon-fibra di vetro per palo diametro 60 mm.

**Base Ø170 mm for Still post**  
Base in fibreglass-nylon for post diameter 60 mm.

**Socle Ø170 mm pour poteau Still**  
Socles en fibre de verre - nylon pour poteau diam.60 mm

COL.	CODE	€
	LB11812	22,00
	LB1181G	34,00
	LB1181E	34,00
	LB1181K	34,00
	LB11811	34,00

### Piastra base a scomparsa palo Still

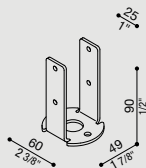

Soluzione alternativa al tradizionale interramento o al basamento palo still mediante staffa di fissaggio a scomparsa. Consiste nell'inserire il palo still sulla staffa preforata da 3mm, realizzata in ferro zincato a caldo per immersione. Accessorio non idoneo per pali still superiori a h. 1500.

**Retractable plate base**  
Alternative solution to the usual burial or to the post base using a retractable fixing bracket. The post is inserted in the 3mm pre-drilled bracket made of hot-dip zinc-coated metal. Accessory not suitable for posts higher than 1500mm.

**Plaque de base rétractable**  
Solution alternative à l'enfouissement traditionnel ou mise en place moyennant un étrier de fixation rétractable du pieu post. Insérer le poteau Still sur l'étrier pré-percé de 3 mm, réalisé en fer galvanisé à chaud par immersion. Accessoire ne convenant pas à des poteaux Still de plus de 1500mm de haut.

COL.	CODE	€
	LB1130006	14,00

### Dima e kit di fissaggio Palo Still

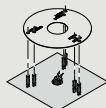

Dima, tirafondi e minuteria per ancoraggio del basamento al terreno.

**Template and fixing kit Still Post diam. 60 mm.**  
Template, fixing bolts and small metal parts to secure the base to the ground.

**Gabarit, tire-fond et visserie pour poteau Still**  
Gabarit, tire-fond et visserie pour l'ancrage du socle au sol.

COL.	CODE	€
	LB11254	13,00

### Box Line

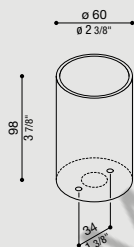

Box per montaggio sporgente a parete, soffitto e pavimento (non per incasso). Corpo in policarbonato ad alto spessore, completo di kit di fissaggio tramite tasselli ad espansione Ø6 mm. Idoneo per tutti i modelli LINE

**Box Line**  
Box for surface wall mounting, ceiling mounting and ground mounting (not recessed). Body made of polycarbonate, high thickness, complete with fixing kit by means of anchor screws Ø6 mm. Suitable for fitting all models Line.

**Box Line**  
Box de montage au mur en saillie, au plafond et au sol (pas à encastrement). Corps en polycarbonate très épais, complet de kit de fixation par chevilles à expansion Ø6 mm. Convient pour tous les modèles Line.

COL.	CODE	€
	LB11231	22,00
	LB1123G	22,00
	LB1123E	22,00
	LB1123K	22,00

### Cover Line

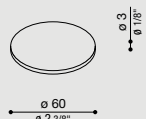

Cover decorativa in Policarbonato, disponibile in diverse colorazioni ed effetti, ricavata da stampaggio ad iniezione. Finitura effetto materico Corten, ottenuta tramite verniciatura. Applicazione della cover senza utensili tramite speciale striscia adesiva.

**Cover Line**  
Polycarbonate decorative cover, injection moulded, available in various colours and designs. Corten painted finish. Application of the cover without tools, by means of a special adhesive strip.

**Cover Line**  
Cover décorative réalisée en polycarbonate et disponible en différents teintes et effets, fabriquée par moulage à injection. Finition effet matière Corten obtenue par vernissage. Application de la cover sans outil à l'aide de bande adhésive spéciale.

COL.	CODE	€
	LB1130001	5,80
	LB1130002	8,30
	LB1130003	8,30
	LB1130004	8,30

### Armatura da incasso Line

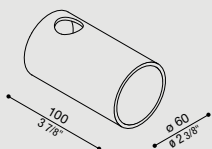

Armatura da incasso, ricavata da palo estruso standard in vetroresina Ø60 mm (misura esterna) lunghezza 100 mm, da posizionare a filo con la superficie di installazione.

**Recess box Line**  
Recess box, made from a standard extruded post in fibreglass Ø60 mm (external dimension), length 100 mm, flush to the installation surface.

**Boîte d'encastrement Line**  
Boîte d'encastrement fabriquée à partir de poteau standard extrudé en fibre de verre Ø60mm (dimension extérieure) longueur 100mm, à placer au ras de la surface de montage.

COL.	CODE	€
	LB11576	10,50



**ACCESSORI**

Accessories / Accessoires

**Cover  
Line 220 Zero**

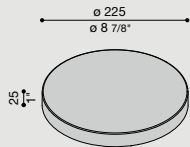

Accessorio CUT-OFF in alluminio; elevata resistenza all'ossidazione grazie al trattamento di passivazione a base di zirconio e alla verniciatura con resine poliestere stabilizzata ai raggi UV. Obbligatoria l'installazione sul modello LINE 220, non compreso.

**Cover Line 220 Zero**  
Alluminium accessory for CUT-OFF version, highly resistant to oxidation thanks to the zirconium based passivation treatment and the UV stabilized polyester resin coating. Model LINE 220 must be mounted (article to be ordered separately).

**Cover Line 220 Zero**  
Accessoire en aluminium pour la version CUT-OFF, haute résistance à l'oxydation grâce au traitement de passivation à base de zirconium et laquage poudre à base de résines polyesters, fixées aux rayons UV. L'installation du modèle LINE 220, non compris, est obligatoire.

COL.	CODE	€
	LB1130011	47,00
	LB1130012	47,00
	LB1130013	47,00
	LB1130014	47,00

**Braccetto  
Line/Line Down**

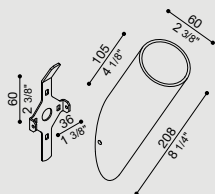

Braccetto diametro 60 mm in Bayblend. Completo di kit di fissaggio a parete. Inclinazione 30°.

**Bracket Line/Line Down**  
Bracket 60 mm. in diameter made of Bayblend. Complete with wall fixing kit. 30° angle.

**Bras Line/Line Down**  
Bras diamètre 60 mm en Bayblend. Kit de fixation murale compris. Inclinaison de 30°.

COL.	CODE	€
	LB1130007	46,00
	LB1130008	46,00
	LB1130009	46,00
	LB1130010	46,00

**Morsettiere**  
Terminal blocks



**Scaricatori SPD**  
Surge protector devices



Pag. 448

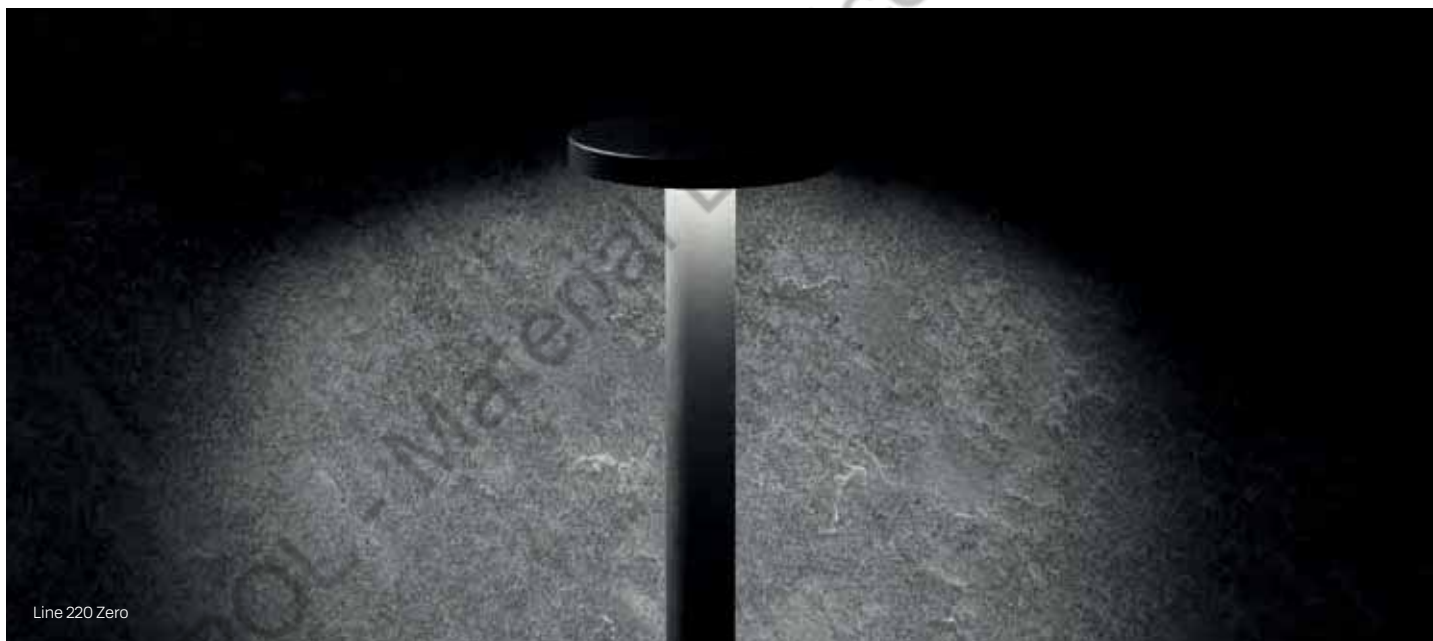

Line 220 Zero



Line

# Line

## ACCESSORI

Accessories / Accessoires

### Still

Palo diametro 60 mm in Bayblend senza basamento. Possibilità di installazione con o senza basamento. Anima interno palo in acciaio zincato per altezze da 2000 mm.

**Still**  
60 mm Bayblend pole without base. Possibility of installation with or without base. Galvanized steel inner pole from H 2000 mm.

**Still**  
Poteau de 60 mm en Bayblend sans socle. Possibilité d'installation avec ou sans socle. Noyau interne en acier galvanisé pour poteau à partir de h. 2000 mm.

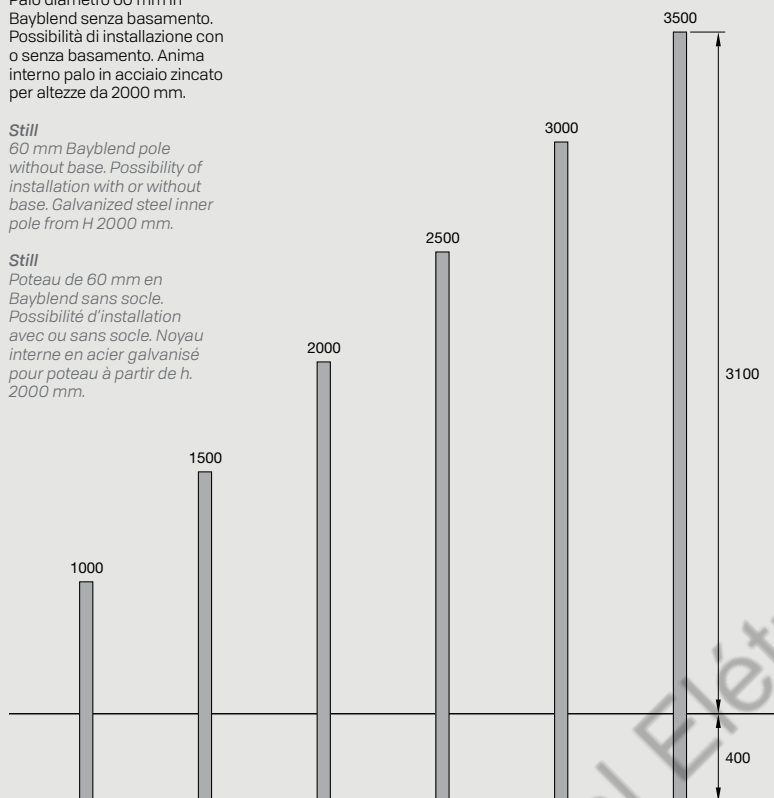

#### H 160 mm

COL.	CODE	€
Black	LB11033	10,50
Grey	LB1103G	34,50
Dark Grey	LB1103E	34,50
Brown	LB1103K	34,50
White	LB11031	34,50

#### H 1500 mm

COL.	CODE	€
Black	LB1100022	20,00
Grey	LB110002G	63,50
Dark Grey	LB110002E	63,50
Brown	LB110002K	63,50
White	LB1100021	63,50

#### H 3000 mm

COL.	CODE	€
Black	LB1100052	52,00
Grey	LB110005G	135,00
Dark Grey	LB110005E	135,00
Brown	LB110005K	135,00
White	LB1100051	135,00

#### H 500 mm

COL.	CODE	€
Black	LB11112	12,00
Grey	LB1111G	38,50
Dark Grey	LB1111E	38,50
Brown	LB1111K	38,50
White	LB11111	38,50

#### H 2000 mm

COL.	CODE	€
Black	LB1100032	36,50
Grey	LB110003G	92,00
Dark Grey	LB110003E	92,00
Brown	LB110003K	92,00
White	LB1100031	92,00

#### H 3500 mm

COL.	CODE	€
Black	LB1100062	62,50
Grey	LB110006G	156,50
Dark Grey	LB110006E	156,50
Brown	LB110006K	156,50
White	LB1100061	156,50

#### H 1000 mm

COL.	CODE	€
Black	LB1100012	13,00
Grey	LB110001G	42,50
Dark Grey	LB110001E	42,50
Brown	LB110001K	42,50
White	LB110001W	42,50

#### H 2500 mm

COL.	CODE	€
Black	LB1100042	47,00
Grey	LB110004G	114,00
Dark Grey	LB110004E	114,00
Brown	LB110004K	114,00
White	LB1100041	114,00

### Tappo Palo Still

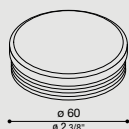

Tappo in polietilene.

Cap for Post Still  
Polyethylene cap.

Couvercle Poteau Still  
Couvercle en polyéthylène.

COL.	CODE	€
Black	LB1100082	10,50
Grey	LB110008G	10,50
Dark Grey	LB110008E	10,50
Brown	LB110008K	10,50
White	LB1100081	10,50

Colori disponibili  
Available colours  
Couleurs disponibles

Nero  
Black  
Noir

Corten

Grigio antracite  
Grey anthracite  
Gris anthracite

Grigio High Tech  
Grey High Tech  
Gris High Tech

Bianco RAL 9010  
White RAL 9010  
Blanc RAL 9010





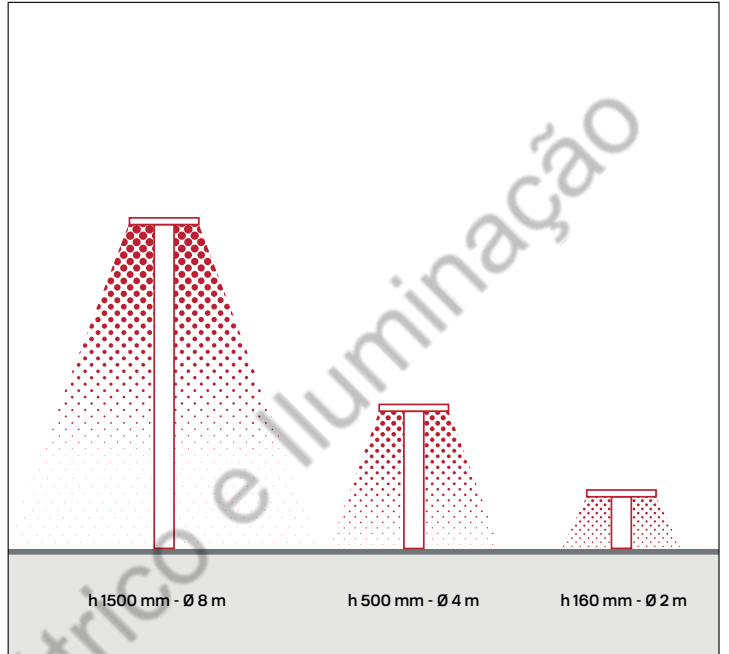
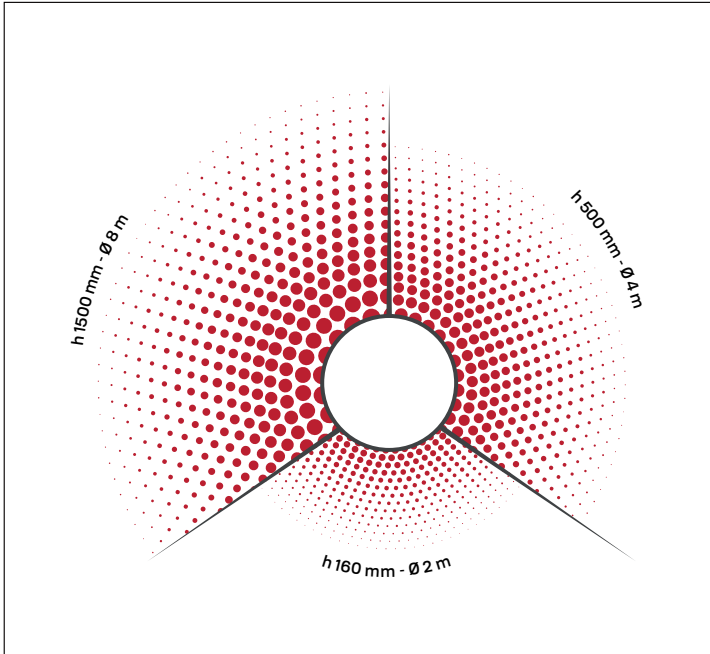

Predisposto per installazione su palo da Ø60 mm standard.  
 Suitable for installation on standard post Ø60 mm.  
 Prédéposé pour l'installation sur Poteau standard Ø60 mm.

# Line





Line 220



Line 330 corridor function



Line 330 corridor function

# Kit Line Post



**Kit-01 / Kit-02 / Kit-03:** Line - adatto anche ad uso esterno. Driver 220 - 240V integrato. Corpo e coperchio in alluminio primario pressofuso. Elevata resistenza all'ossidazione grazie al trattamento di passivazione a base di zirconio e alla verniciatura con resine poliestere stabilizzata ai raggi UV.

Diffusore in Policarbonato ottico ad alto spessore con finitura PoliGLASS, tramite stampaggio ad iniezione proprio e successive rifiniture manuali.

**Kit-04 / Kit-05 / Kit-06:** Line Down - Versione con sorgente luminosa direzionata verso il basso. Ideale per l'illuminazione di percorsi e camminamenti ed in contesti che necessitano un ridotto valore di abbagliamento.

**Kit-07 / Kit-08 / Kit-09:** Line 220 -Tappo superiore in Policarbonato nero, ottenuto da stampaggio ad iniezione.

Guarnizioni in silicone per il mantenimento del grado IP66.

Bulloneria in acciaio inox A4.

Predisposto per installazione rapida in pali Ø60 standard, tramite molle in acciaio inox ad espansione.

Predisposizione per vite di sicurezza.

Cover decorativa in Policarbonato, disponibile in diverse colorazioni ed effetti, ricavato da stampaggio ad iniezione.

Finitura effetto materico Corten, ottenuta tramite verniciatura. Applicazione della cover senza utensili tramite speciale striscia adesiva.

Palo diametro 60 mm, in Bayblend senza basamento, altezza: 1500 mm - 1000 mm - 500 mm.

Piastra base a scomparsa: soluzione alternativa al tradizionale interrimento o al basamento palo still mediante staffa di fissaggio a scomparsa. Consiste nell'inserire il palo still sulla staffa preforata da 3mm, realizzata in ferro zincato a caldo per immersione. Accessorio non idoneo per pali still superiori a h.1500.

**LED 4000K (N), 3000K (3) o 2700K (2). Alimentazione diretta 220-240V. Nessun rischio fotobiologico, RG0 gruppo di rischio esente (EN62471).**



**ENG Kit-01 / Kit-02 / Kit-03:** Line - suitable for indoor and outdoor use. Integrated driver 220 - 240V.

Body and cover made of die-cast aluminium primary alloy; highly resistant to oxidization thanks to the zirconium-based passivation treatment and UV stabilized polyester resin coating.

Diffuser made of very thick optical polycarbonate, poliGLASS finish, injection moulded and subsequent manual finishing.

**Kit-04 / Kit-05 / Kit-06:** Line Down - Version with a light source directed downwards. Ideal for illuminating paths and walkways and in locations that require a reduced amount of glare.

**Kit-07 / Kit-08 / Kit-09:** Line 220 - Upper black polycarbonate cap, injection moulded in-house. Silicone gaskets IP66. A4 stainless steel nuts and bolts. Suitable for quick installation in standard posts Ø60 by means of stainless steel springs. Polycarbonate decorative cover, injection moulded, available in various colours and designs.

Corten painted finish. Application of the cover without tools, by means of a special adhesive strip. 60 mm. diameter POST.

Post made of Bayblend without base, h: 1500 mm - 1000 mm - 500 mm.

Retractable plate base: alternative solution to the usual burial or to the post base using a retractable fixing bracket. The post is inserted in the 3mm pre-drilled bracket made of hot-dip zinc-coated metal.

Accessory not suitable for posts higher than 1500mm.

LED 4000K (N), 3000K (3) or 2700K (2). Integral ballast 220-240V. No risk of photobiological damage, RGO group (EN62471).

**FRA Kit-01 / Kit-02 / Kit-03:** Line – Également adapté à l'usage à l'extérieur. Alimentation intégrée 220 - 240V. Corps et couverture en aluminium primaire injecté; haute résistance à l'oxydation grâce au traitement de passivation à base de zirconium et laquage poudre à base de résines polyesters, fixées au rayon UV. Diffuseur réalisé en polycarbonate, d'une épaisseur optique élevée, effect PoliGLASS, par moulage par injection et finitions manuelles successives.

**Kit-04 / Kit-05 / Kit-06:** Line Down – Faisceau dirigé vers le bas : idéal en balisage pour éclairer les chemins ou allées et éviter les éblouissements.

**Kit-07 / Kit-08 / Kit-09:** Line 220 - Bouchon supérieur en Polycarbonate noir, s'obtient du moulage à injection propre. Joints en silicone pour maintenir degré IP66. Visserie en acier inox type A4. Prédéposé pour l'installation rapide sur poteaux standards Ø60 à l'aide de ressorts à lames en inox. Cover décoratif réalisé en polycarbonate et disponible en différents teintes et effets, fabriqué par moulage à injection. Finition effet matière Corten obtenue par vernissage. Application de la cover sans outil à l'aide de bande adhésive spéciale. Poteau dia 60 mm. Poteau en bayblend, sans socle, 1500 mm - 1000 mm - 500 mm. Solution alternative à l'enfouissement traditionnel ou mise en place moyennant un étrier de fixation rétractable du poteau still. Insérer le poteau post sur l'étrier pré-percé de 3 mm, réalisé en fer galvanisé à chaud par immersion. Accessoire ne convenant pas à des poteaux still de plus de 1500mm de haut.

LED 4000K (N), 3000K (3) ou 2700K (2) (blanche chaud). Alimentation intégrée 220-240. Pas de risque photobiologique, RGO groupe (EN62471).

**Kit-01 Line Post H500**



**Kit-02 Line Post H1000**



**Kit-03 Line Post H1500**



**Kit-04 Line Down Post H500**



**Kit-05 Line Down Post H1000**



**Kit-06 Line Down Post H1500**



**Kit-07 Line 220 Post H500**



**Kit-08 Line 220 Post H1000**



**Kit-09 Line 220 Post H1500**





# Kit Line Post

## Kit-01 Line Post H500

DIFF.  
POLIGLASS

IP 66 IK 08 5J xx7 CE UK CA

LED	W	LM	REAL LM	COL.	CODE *	€	* LED COLOUR
	6,5	700	604	⊕	LL113002□	135,50	N 4000K
				⊕	LL113003□	165,00	3 3000K, lm -5%
				⊕	LL113004□	165,00	2 2700K, lm -5%
				⊕	LL113005□	165,00	

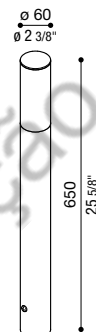

Kit composto dagli attuali codici LL113000N/3/2 + LB1130001/2/3/4 + LB11112/G/E/K + LB1130006.

Kit consisting of the current codes LL113000N/3/2 + LB1130001/2/3/4 + LB11112/G/E/K + LB1130006.

Kit composé des codes actuels LL113000N/3/2 + LB1130001/2/3/4 + LB11112/G/E/K + LB1130006.

## Kit-02 Line Post H1000

DIFF.  
POLIGLASS

IP 66 IK 08 5J xx7 CE UK CA

LED	W	LM	REAL LM	COL.	CODE *	€	* LED COLOUR
	6,5	700	604	⊕	LL113130□	137,00	N 4000K
				⊕	LL113131□	168,50	3 3000K, lm -5%
				⊕	LL113132□	168,50	2 2700K, lm -5%
				⊕	LL113133□	168,50	

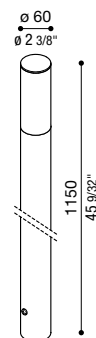

Kit composto dagli attuali codici LL113000N/3/2 + LB1130001/2/3/4 + LB1100012/G/E/K + LB1130006.

Kit consisting of the current codes LL113000N/3/2 + LB1130001/2/3/4 + LB1100012/G/E/K + LB1130006.

Kit composé des codes actuels LL113000N/3/2 + LB1130001/2/3/4 + LB1100012/G/E/K + LB1130006.

## Kit-03 Line Post H1500

DIFF.  
POLIGLASS

IP 66 IK 08 5J xx7 CE UK CA

LED	W	LM	REAL LM	COL.	CODE *	€	* LED COLOUR
	6,5	700	604	⊕	LL113006□	143,50	N 4000K
				⊕	LL113007□	190,00	3 3000K, lm -5%
				⊕	LL113008□	190,00	2 2700K, lm -5%
				⊕	LL113009□	190,00	

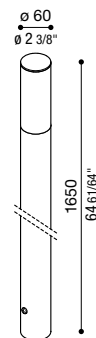

Kit composto dagli attuali codici LL113000N/3/2 + LB1130001/2/3/4 + LB1100022/G/E/K + LB1130006.

Kit consisting of the current codes LL113000N/3/2 + LB1130001/2/3/4 + LB1100022/G/E/K + LB1130006.

Kit composé des codes actuels LL113000N/3/2 + LB1130001/2/3/4 + LB1100022/G/E/K + LB1130006.



### Kit-04 Line Down Post H500

DIFF. POLIGLASS



IP 66 IK 08 5J xx7 CE UK CA

LED	W	LM	REAL LM	COL.	CODE *	€	* LED COLOUR
6	620	431	220-240 V	Black	LL113010	153,00	N 4000K
				Grey	LL113011	182,00	3 3000K, lm -5%
				Dark Grey	LL113012	182,00	2 2700K, lm -5%
				Brown	LL113013	182,00	

Kit composto dagli attuali codici LL113001N/3/2 + LB1130001/2/3/4 + LB11112/G/E/K + LB1130006

Kit consisting of the current codes LL113001N/3/2 + LB1130001/2/3/4 + LB11112/G/E/K + LB1130006

Kit composé des codes actuels LL113001N/3/2 + LB1130001/2/3/4 + LB11112/G/E/K + LB1130006

### Kit-05 Line Down Post H1000

DIFF. POLIGLASS

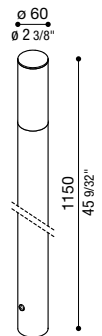

IP 66 IK 08 5J xx7 CE UK CA

LED	W	LM	REAL LM	COL.	CODE *	€	* LED COLOUR
6	620	604	220-240 V	Black	LL113134	154,00	N 4000K
				Grey	LL113135	185,50	3 3000K, lm -5%
				Dark Grey	LL113136	185,50	2 2700K, lm -5%
				Brown	LL113137	185,50	

Kit composto dagli attuali codici LL113001N/3/2 + LB1130001/2/3/4 + LB1100012/G/E/K + LB1130006

Kit consisting of the current codes LL113001N/3/2 + LB1130001/2/3/4 + LB1100012/G/E/K + LB1130006

Kit composé des codes actuels LL113001N/3/2 + LB1130001/2/3/4 + LB1100012/G/E/K + LB1130006

### Kit-06 Line Down Post H1500

DIFF. POLIGLASS

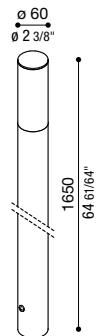

IP 66 IK 08 5J xx7 CE UK CA

LED	W	LM	REAL LM	COL.	CODE *	€	* LED COLOUR
6	620	431	220-240 V	Black	LL113014	160,00	N 4000K
				Grey	LL113015	207,00	3 3000K, lm -5%
				Dark Grey	LL113016	207,00	2 2700K, lm -5%
				Brown	LL113017	207,00	

Kit composto dagli attuali codici LL113001N/3/2 + LB1130001/2/3/4 + LB1100022/G/E/K + LB1130006

Kit consisting of the current codes LL113001N/3/2 + LB1130001/2/3/4 + LB1100022/G/E/K + LB1130006

Kit composé des codes actuels LL113001N/3/2 + LB1130001/2/3/4 + LB1100022/G/E/K + LB1130006

#### Finishing

Nero da stampaggio Black Noir moulé	Grigio antracite RAL 7021 Grey anthracite RAL 7021 Gris anthracite RAL 7021
Grigio High Tech RAL 9006 Grey High Tech RAL 9006 Gris High Tech RAL 9006	Corten Corten Corten

#### \* Led colour

- N 4000K
- 3 3000K, lm -5%
- 2 2700K, lm -5%

**Completa il codice** sostituendo al quadrato rosso la lettera o il numero corrispondente alla temperatura colore scelta.

**Complete the code** by replacing the red box with the letter or number corresponding to the selected colour temperature.

**Compléter le code** en remplaçant le carré rouge par la lettre ou le numéro correspondant à la sélection de température couleur.

#### ✓ Alimentatore integrato

Integrated driver  
Alimentation intégrée

# Kit Line Post

## Kit-07 Line 220 Post H500

DIFF. POLIGLASS

IP 66 IK 08 5J xx7 CE UK CA

LED	W	LM	REAL LM	COL.	CODE *	€	* LED COLOUR
11	1350	910	220-240 V		LL113104	141,50	N 4000K
					LL113105	168,00	3 3000K, lm -5%
					LL113106	168,00	2 2700K, lm -5%
					LL113107	168,00	

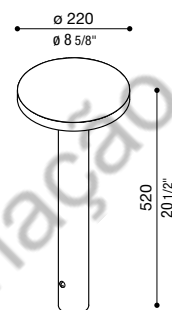

Kit composto dagli attuali codici LL113100N/3/2 + LB11112/G/E/K + LB1130006

Kit consisting of the current codes LL113100N/3/2 + LB11112/G/E/K + LB1130006

Kit composé des codes actuels LL113100N/3/2 + LB11112/G/E/K + LB1130006

## Kit-08 Line 220 Post H1000

DIFF. POLIGLASS

IP 66 IK 08 5J xx7 CE UK CA

LED	W	LM	REAL LM	COL.	CODE *	€	* LED COLOUR
11	1350	910	220-240 V		LL113138	143,00	N 4000K
					LL113139	172,00	3 3000K, lm -5%
					LL113140	172,00	2 2700K, lm -5%
					LL113141	172,00	

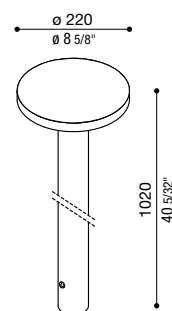

Kit composto dagli attuali codici LL113100N/3/2 + LB1100012/G/E/K + LB1130006

Kit consisting of the current codes LL113100N/3/2 + LB1100012/G/E/K + LB1130006

Kit composé des codes actuels LL113100N/3/2 + LB1100012/G/E/K + LB1130006

## Kit-09 Line 220 Post H1500

DIFF. POLIGLASS

IP 66 IK 08 5J xx7 CE UK CA

LED	W	LM	REAL LM	COL.	CODE *	€	* LED COLOUR
11	1350	910	220-240 V		LL113108	149,00	N 4000K
					LL113109	193,00	3 3000K, lm -5%
					LL113110	193,00	2 2700K, lm -5%
					LL113111	193,00	

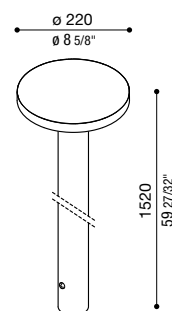





Kit composto dagli attuali codici LL113100N/3/2 + LB1100022/G/E/K + LB1130006

Kit consisting of the current codes LL113100N/3/2 + LB1100022/G/E/K + LB1130006

Kit composé des codes actuels LL113100N/3/2 + LB1100022/G/E/K + LB1130006

### Finishing

 Nero da stampaggio Black Noir moulé	 Grigio antracite RAL 7021 Grey anthracite RAL 7021 Gris anthracite RAL 7021
 Grigio High Tech RAL 9006 Grey High Tech RAL 9006 Gris High Tech RAL 9006	 Corten Corten Corten

### \* Led colour

- N 4000K
- 3 3000K, lm -5%
- 2 2700K, lm -5%

**Completa il codice**  
sostituendo al quadrato rosso la lettera o il numero corrispondente alla temperatura colore scelta.

**Complete the code**  
by replacing the red box with the letter or number corresponding to the selected colour temperature.

**Compléter le code**  
en remplaçant le carré rouge par la lettre ou le numéro correspondant à la sélection de température couleur.

### ✓ Alimentatore integrato Integrated driver Alimentation intégrée



Kit-07 Line 220 Post H500

# Still



Palo diametro 60 mm in Bayblend senza basamento. Possibilità di installazione con o senza basamento. Anima interno palo in acciaio zincato per altezze da 2000 mm.

**Still**  
60 mm Bayblend pole without base. Possibility of installation with or without base. Galvanized steel inner pole from H 2000 mm.

**Still**  
Poteau de 60 mm en Bayblend sans socle. Possibilité d'installation avec ou sans socle. Noyau interne en acier galvanisé pour poteau à partir de h. 2000 mm.

H 160 mm			H 1000 mm			H 2000 mm			H 3000 mm		
COL.	CODE	€	COL.	CODE	€	COL.	CODE	€	COL.	CODE	€
■	LB11033	10,50	■	LB1100012	13,00	■	LB1100032	36,50	■	LB1100052	52,00
■	LB1103G	34,50	■	LB110001G	42,50	■	LB110003G	92,00	■	LB110005G	135,00
■	LB1103E	34,50	■	LB110001E	42,50	■	LB110003E	92,00	■	LB110005E	135,00
■	LB1103K	34,50	■	LB110001K	42,50	■	LB110003K	92,00	■	LB110005K	135,00
■	LB11031	34,50	■	LB110001W	42,50	■	LB1100031	92,00	■	LB1100051	135,00
H 500 mm			H 1500 mm			H 2500 mm			H 3500 mm		
COL.	CODE	€	COL.	CODE	€	COL.	CODE	€	COL.	CODE	€
■	LB11112	12,00	■	LB1100022	20,00	■	LB1100042	47,00	■	LB1100062	62,50
■	LB1111G	38,50	■	LB110002G	63,50	■	LB110004G	114,00	■	LB110006G	156,50
■	LB1111E	38,50	■	LB110002E	63,50	■	LB110004E	114,00	■	LB110006E	156,50
■	LB1111K	38,50	■	LB110002K	63,50	■	LB110004K	114,00	■	LB110006K	156,50
■	LB11111	38,50	■	LB1100021	63,50	■	LB1100041	114,00	■	LB1100061	156,50





Anima interno palo in acciaio zincato per altezze da 2 m.

*Galvanized steel inner pole from H 2 m.*

*Noyau interne en acier galvanisé pour poteau à partir de h. 2 m.*

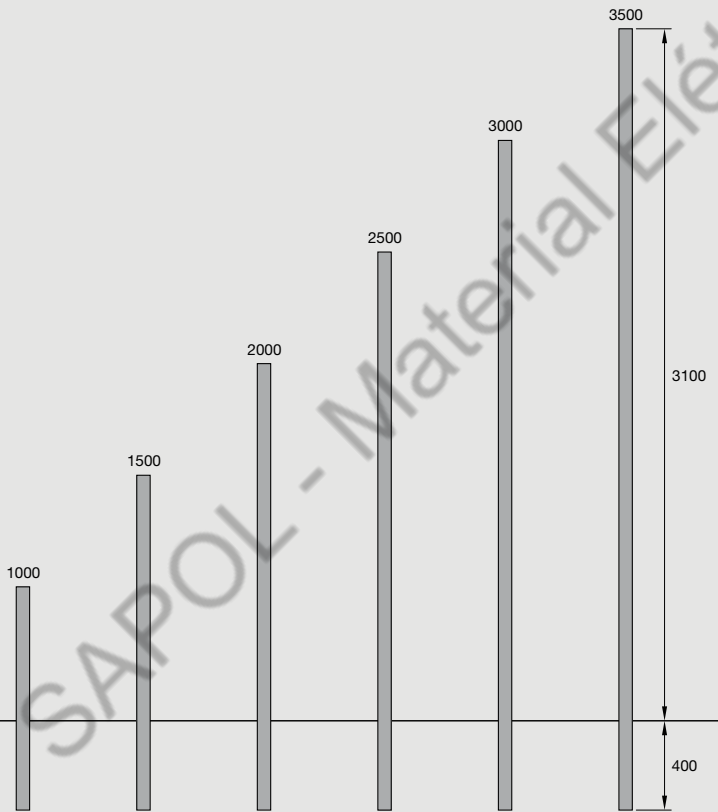

Colori disponibili  
Available colours  
Couleurs disponibles

Nero  
Black  
Noir

Corten

Grigio antracite  
Grey anthracite  
Gris anthracite

Grigio High Tech  
Grey High Tech  
Gris High Tech

Bianco RAL 9010  
White RAL 9010  
Blanc RAL 9010

### Tappo Palo Still

Tappo in polietilene.

*Cap for Post Still  
Polyethylene cap.*

*Couvercle Poteau Still  
Couvercle en polyéthylène.*

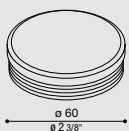

COL.	CODE	€
Black	LB1100082	10,50
Grey	LB110008G	10,50
Dark Grey	LB110008E	10,50
Brown	LB110008K	10,50
White	LB1100081	10,50

# Tag



LED



indoor



outdoor

**ACCESSORI**

Accessories / Accessoires

Pag. 150



Adatto anche ad uso esterno.

Corpo e snodo in alluminio pressofuso; elevata resistenza all'ossidazione grazie al trattamento di passivazione a base di zirconio e alla verniciatura con resine poliestere stabilizzata ai raggi UV. Fornito con 1 m di cavo di alimentazione H05RN-F pre-cablato. Diffusore in vetro temperato e serigrafato. Riflettore in alluminio. Guarnizioni in silicone per mantenimento grado IP66. Bulloneria in acciaio inox A4. Regolazione inclinazione di 180°.

TAG 110 fornito di sacchetto disidratante ad elevata capacità igroscopica.

**LED 4000K (N), 3000K (3) o 2700 (2). Alimentazione diretta 220-240V.**

**ENG** Also suitable for outdoor use.

Die-cast aluminium body and joint; highly resistant to oxidation thanks to the zirconium based passivation treatment and the UV stabilized polyester resin coating. Provided with 1m of prewired power cable H05RN-F. Heat tempered and serigraphed glass diffuser.

Aluminium reflector. Silicone gaskets to maintain IP66 rating.

A4 stainless steel nuts and bolts. 180° angle adjustment.

TAG 110 with highly hygroscopic dehydrating bag.

**LED 4000K (N), 3000K (3) or 2700K (2). Integral ballast 220-240V.**

**FRA** Également adapté à l'usage à l'extérieur.

Corps et articulation en aluminium moulé sous pression; haute résistance à l'oxydation grâce au traitement de passivation à base de zirconium et laquage poudre à base de résines polyesters, fixées aux rayons UV. Fourni avec 1m de câble d'alimentation H05RN-F-pré-cablé. Diffuseur en verre trempé et sérigraphié.

Réflecteur en aluminium. Joints en silicone pour maintenir degré IP66.

Visserie en acier inox type A4. Réglage inclinaison de 180°.

TAG 110 avec sac déshydratant avec capacité hygroscopique.

**LED 4000K (N), 3000K (3) ou 2700K (2) (blanche chaud). Alimentation intégrée 220-240.**

**Tag 110**



**Tag 110 White**



**Outdoor  
e waterproof**



**Alimentazione diretta**  
Direct power supply  
Alimentation directe

**Tag 210**



**Tag 210 White**



**Pre-cablato**  
Pre-wired  
Pré-câblé



**Anni di garanzia  
sul circuito LED**  
Years warranty on LED circuit  
Ans de garantie sur la source LED

**Tag 210 asimmetrico**



**Tag 210 Power**



Interasse fori per fissaggio  
Fixing holes  
Trous de fixation

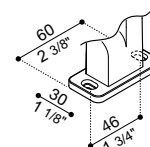

# Tag

## Tag 110



DIFF.  
TRASP.

IP 66 IK 06 1J xx3 CE UK CA

LED	W	LM	REAL LM	COL.	CODE *	€	* LED COLOUR
	10	1200	672	☉	LL115000□	64,50	N 4000K
				☑	LL115001□	64,50	3 3000K, lm -5%
				☑	LL115002□	64,50	2 2700K, lm -5%
				☑	LL115003□	64,50	

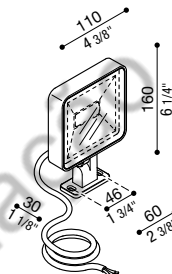

Apparecchio inaccessibile. Nessun rischio fotobiologico, RGO gruppo di rischio esente (EN62471).

Inaccessible device. No risk of photobiological damage, RGO group (EN62471).

Appareil câblé en usine. Pas de risque photobiologique, RGO groupe (EN62471).

## Tag 110 White



DIFF.  
OPAL.

IP 66 IK 06 1J xx3 CE UK CA

LED	W	LM	REAL LM	COL.	CODE *	€	* LED COLOUR
	10	1200	473	☉	LL115004□	64,50	N 4000K
				☑	LL115005□	64,50	3 3000K, lm -5%
				☑	LL115006□	64,50	2 2700K, lm -5%
				☑	LL115007□	64,50	

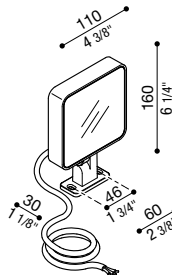

Versione con vetro serigrafato bianco. Apparecchio inaccessibile. Nessun rischio fotobiologico, RGO gruppo di rischio esente (EN62471).

Version with white serigraphed glass. Inaccessible device. No risk of photobiological damage, RGO group (EN62471).

Version avec verre blanc sérigraphié. Appareil câblé en usine. Pas de risque photobiologique, RGO groupe (EN62471).

## Tag 210



DIFF.  
TRASP.

IP 66 IK 06 1J xx3 CE UK CA

LED	W	LM	REAL LM	COL.	CODE *	€	* LED COLOUR
	25	3500	2585	☉	LL115100□	122,50	N 4000K
				☑	LL115101□	122,50	3 3000K, lm -5%
				☑	LL115102□	122,50	2 2700K, lm -5%
				☑	LL115103□	122,50	

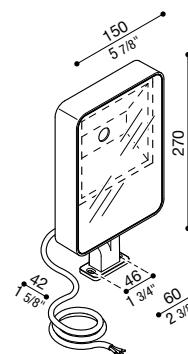

Predisposto per doppio ingresso alimentazione. Nessun rischio fotobiologico nelle normali condizioni di impiego, RG1 gruppo di rischio basso (EN62471).

Prearranged for double power input. No photobiological risk under normal operating conditions, RG1 low risk group (EN62471).

Équipé d'une double entrée alimentation. Aucun risque photobiologique dans des conditions d'utilisation normales, RG1 groupe de risque bas (EN62471).

### Finishing

	Bianco RAL 9010 White RAL 9010 Blanc RAL 9010		Grigio antracite RAL 7021 Grey anthracite RAL 7021 Gris anthracite RAL 7021
	Grigio High Tech RAL 9006 Grey High Tech RAL 9006 Gris High Tech RAL 9006		Corten Corten Corten

☑ Alimentatore integrato  
Integrated driver  
Alimentation intégrée



### Tag 210 White



DIFF. OPAL.

IP 66 IK 06 1J xx3 CE UK CA

LED	W	LM	REAL LM	COL.	CODE *	€	* LED COLOUR
25	3500	1808	220-240 V		LL115108□	122,50	N 4000K
					LL115109□	122,50	3 3000K, Im -5%
					LL115110□	122,50	2 2700K, Im -5%
					LL115111□	122,50	

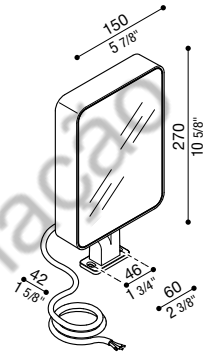

Versione con vetro serigrafato bianco. Predisposto per doppio ingresso alimentazione. Nessun rischio fotobiologico nelle normali condizioni di impiego, RG1 gruppo di rischio basso (EN62471).

Version with white serigraphed glass. Prearranged for double power input. No photobiological risk under normal operating conditions, RG1 low risk group (EN62471).

Version avec verre blanc sérigraphié. Équipé d'une double entrée alimentation. Aucun risque photo biologique dans des conditions d'utilisation normales, RG1 groupe de risque bas (EN62471).

### Tag 210 asimmetrico



DIFF. TRASP.

IP 66 IK 06 1J xx3 CE UK CA

LED	W	LM	REAL LM	COL.	CODE *	€	* LED COLOUR
25	3500	2386	220-240 V		LL115104□	130,50	N 4000K
					LL115105□	130,50	3 3000K, Im -5%
					LL115106□	130,50	2 2700K, Im -5%
					LL115107□	130,50	

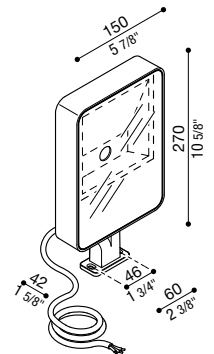

Predisposto per doppio ingresso alimentazione. Nessun rischio fotobiologico nelle normali condizioni di impiego, RG1 gruppo di rischio basso (EN62471).

Prearranged for double power input. No photobiological risk under normal operating conditions, RG1 low risk group (EN62471).

Équipé d'une double entrée alimentation. Aucun risque photo biologique dans des conditions d'utilisation normales, RG1 groupe de risque bas (EN62471).

### Tag 210 Power



DIFF. TRASP.

IP 66 IK 06 1J xx3 CE UK CA

LED	W	LM	REAL LM	COL.	CODE **	€	* OPTIC	* LED COLOUR
35	4500	3120	220-240 V		LL115166□	163,00	S 27°	N 4000K
					LL115167□	163,00	W 90°	3 3000K, Im -5%
					LL115168□	163,00	A Asymm.	2 2700K, Im -5%
					LL115169□	163,00		

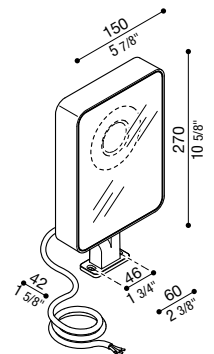

Predisposto per doppio ingresso alimentazione. Nessun rischio fotobiologico nelle normali condizioni di impiego, RG1 gruppo di rischio basso (EN62471).

Prearranged for double power input. No photobiological risk under normal operating conditions, RG1 low risk group (EN62471).

Équipé d'une double entrée alimentation. Aucun risque photo biologique dans des conditions d'utilisation normales, RG1 groupe de risque bas (EN62471).

**\* Led colour** **Completa il codice** **Complete the code** **Compléter le code**  
 [4] 4000K sostituendo al quadrato rosso la lettera o il numero corrispondente alla temperatura colore scelta.  
 [7] 3000K Im -5%  
 [N] 3000K Im -5%  
 by replacing the red box with the letter or number corresponding to the selected colour temperature.  
 en remplaçant le carré rouge par la lettre ou le numéro correspondant à la sélection de température couleur.

**\* Optic** **Completa il codice** **Complete the code** **Compléter le code**  
 □ sostituendo al quadrato grigio la lettera corrispondente al modello di ottica scelta.  
 by replacing the grey box with the letter corresponding to the selected optic model.  
 en remplaçant le carré gris par la lettre correspondante au modèle de lentille choisie.



# Tag

## ACCESSORI

Accessories / Accessoires

### Still

Palo diametro 60 mm in Bayblend senza basamento. Possibilità di installazione con o senza basamento. Anima interno palo in acciaio zincato per altezze da 2000 mm.

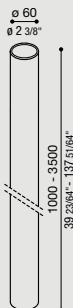

**Still**  
60 mm Bayblend pole without base.  
Possibility of installation with or without base.  
Galvanized steel inner pole from H 2000 mm.

**Still**  
Poteau de 60 mm en Bayblend sans socle.  
Possibilité d'installation avec ou sans socle. Noyau interne en acier galvanisé pour poteau à partir de h. 2000 mm.

H 160 mm			H 1000 mm			H 2000 mm			H 3000 mm		
COL.	CODE	€	COL.	CODE	€	COL.	CODE	€	COL.	CODE	€
	LB11033	10,50		LB1100012	13,00		LB1100032	36,50		LB1100052	52,00
	LB1103G	34,50		LB110001G	42,50		LB110003G	92,00		LB110005G	135,00
	LB1103E	34,50		LB110001E	42,50		LB110003E	92,00		LB110005E	135,00
	LB1103K	34,50		LB110001K	42,50		LB110003K	92,00		LB110005K	135,00
	LB11031	34,50		LB110001W	42,50		LB1100031	92,00		LB1100051	135,00

H 500 mm			H 1500 mm			H 2500 mm			H 3500 mm		
COL.	CODE	€	COL.	CODE	€	COL.	CODE	€	COL.	CODE	€
	LB11112	12,00		LB1100022	20,00		LB1100042	47,00		LB1100062	62,50
	LB1111G	38,50		LB110002G	63,50		LB110004G	114,00		LB110006G	156,50
	LB1111E	38,50		LB110002E	63,50		LB110004E	114,00		LB110006E	156,50
	LB1111K	38,50		LB110002K	63,50		LB110004K	114,00		LB110006K	156,50
	LB11111	38,50		LB1100021	63,50		LB1100041	114,00		LB1100061	156,50

Disponibile colore bianco su richiesta - White version available - Version blanc disponible

### Adattatore Laterale Palo Still Ø 60 Tag

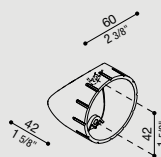

Adattatore in policarbonato nero per installazione laterale Tag 110/ Tag 210 su palo standard Ø 60 mm. Possibilità di regolare la rotazione dell'adattatore a 360°. Da abbinare a "Adattatore Palo Post Ø60 Tag" non incluso.

**Side Adaptor Still Post Ø 60 Tag**  
Adaptor in black polycarbonate for Tag 110/ Tag 210 for side installation on standard post Ø 60mm.  
Adaptor 360° angle adjustment. To be combined with "Adaptor for Post Ø60 Tag" not included.

**Adaptateur Latéral Pour Poteau Still Ø 60 Tag**  
Adaptateur en polycarbonate noir pour installation latérale sur poteau standard Ø60 mm.  
Possibilité de régler la rotation de l'adaptateur à 360°. Produit pour accompagner l'adaptateur "Poteau Post Ø60 Tag", pas inclus.

COL.	CODE	€
	LB1150039	11,50
	LB1150036	11,50
	LB1150037	11,50
	LB1150038	11,50

### Adattatore palo Still Ø 60 Tag

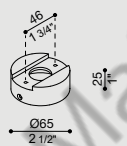

Adattatore per installazione Tag110/210 su palo standard Ø60 mm. Corpo realizzato in alluminio pressofuso con elevata resistenza all'ossidazione, verniciato con resine di poliesteri stabilizzate ai raggi UV. Bulloneria in acciaio inox A4.

**Adaptor for Still Post Ø 60 Tag**  
Adapter for installation Tag 110/210 on a standard post Ø60 mm.  
Die-cast aluminum Body, highly resistant to oxidization, coated with UV-stabilised polyester resins. A4 stainless steel nuts and bolts.

**Adaptateur poteau Still Ø60 Tag**  
Adaptateur pour installation Tag110/210 sur poteau standard Ø60 mm. Corps réalisé en aluminium moulé sous pression avec excellente résistance à l'oxydation, peinture avec résines polyester stabilisées aux rayons UV. Boulonnerie en acier inox A4.

COL.	CODE	€
	LB1150011	11,50
	LB1150012	11,50
	LB1150013	11,50
	LB1150014	11,50

### Adattatore Tag per scatola 503

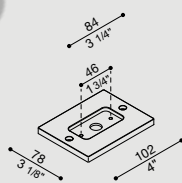

Adattatore per montaggio Tag110 su scatola incasso standard 503. Corpo in alluminio pressofuso; elevata resistenza all'ossidazione grazie al trattamento di passivazione a base di zirconio e alla verniciatura con resine poliesteri stabilizzate ai raggi UV. Bulloneria in acciaio inox A4.

**Adapter for fitting Tag 110 on the standard recess box 503.** Body made of die-cast aluminium; highly resistant to oxidization thanks to the zirconium based passivation process and the coating with UV-stabilised polyester resins. A4 stainless steel nuts and bolts.

**Adaptateur pour montage Tag110 sur boîte encastrement standard 503.** Corps, articulation en aluminium moulé sous pression; excellente résistance à l'oxydation grâce au traitement de passivation à base de zirconium et à la peinture avec résines polyester stabilisées aux rayons UV. Boulonnerie en acier inox A4.

COL.	CODE	€
	LB1150003	17,50
	LB1150004	17,50
	LB1150005	17,50
	LB1150006	17,50

### Morsettiera coassiale

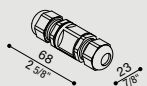

Morsettiera coassiale a 3 poli, IP68, per cavo Ø 7/12 mm.

**Coaxial Terminal block**  
Coaxial 3-pole terminal block, IP68, for cable diameter 7/12 mm.

**Bornier coaxial**  
Bornier coaxial à 3 pôles, IP68, pour câble diam. 7/12 mm

COL.	CODE	€
	LB11293	16,00

### Morsettiera lineare a 3 vie

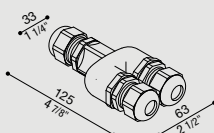

Morsettiera lineare a 3 vie a 3 poli, IP68, per cavo Ø 7/13,5 mm.

**3 way linear terminal block**  
3-way 3-pole linear terminal block, IP68, for cable Ø 7/13.5 mm.

**Bornier linéaire 3 voies**  
Bornier linéaire 3 voies à 3 pôles, IP68, pour câble diam. 7/13,5 mm

COL.	CODE	€
	LB11294	25,50



**ACCESSORI**

Accessories / Accessoires

**Accessorio giardino - Tag**

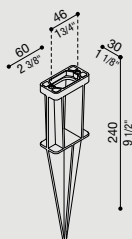

Accessorio da giardino da abbinare a Tag 110/210 realizzato in materiale termoplastico. Adatto per uso esterno, idoneo per installazione a terra.

**Garden accessory**  
Thermoplastic garden accessory for Tag 110/ 210. Suitable for outdoor use and ground application.

**Accessoire de jardin**  
Accessoire de jardin en matériau thermoplastique à associer à Tag 110/ 210. Eglament adapté à l'usage \* extérieur. Convient pour une utilisation au sol.

COL.	CODE	€
	<b>LB1150035</b>	<b>11,50</b>

**Braccetto Tag110/Tag210**

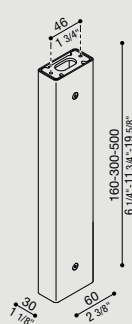

Possibilità di installazione Tag 110/210 su palo, altezza: 500 mm – 300 mm – 160 mm, predisposto per installazione a e parete e soffitto. Palo in estruso di alluminio. Elevata resistenza all'ossidazione grazie al trattamento di passivazione a base di zirconio e alla verniciatura con resine poliestere stabilizzata ai raggi UV. Bulloneria in acciaio inox A4. Completo di kit di fissaggio e cavo tirante in acciaio.

**Bracket Tag110/Tag210**  
Possibility of installation Tag 110/210 on a post, height: 500 mm - 300 mm. - 160 mm, designed for wall or ceiling installation. Post made of extruded aluminium. Highly resistant to oxidization thanks to the zirconium based passivation process and the coating with UV-stabilised polyester resins. A4 stainless steel nuts and bolts. Complete with fastening kit and stainless steel cable.

**Bras Tag110/Tag210**  
Possibilité d'installation Tag 110/210 sur poteau, hauteur : 500 mm - 300 mm - 160 mm, prévu pour installation au mur et au plafond. Poteau en aluminium extrudé. Excellente résistance à l'oxydation grâce au traitement de passivation à base de zirconium et à la peinture avec résines polyester stabilisées aux rayons UV. Boulonnerie en acier inox A4. Kit de fixation et tige en acier compris.

Lunghezza 160 mm - Length 160 mm - Longueur 160 mm  
Lunghezza 300 mm - Length 300 mm - Longueur 300 mm  
Lunghezza 500 mm - Length 500 mm - Longueur 500 mm

COL.	CODE	€	COL.	CODE	€	COL.	CODE	€
	<b>LB1150015</b>	<b>40,50</b>		<b>LB1150019</b>	<b>47,00</b>		<b>LB1150023</b>	<b>52,50</b>
	<b>LB1150016</b>	<b>40,50</b>		<b>LB1150020</b>	<b>47,00</b>		<b>LB1150024</b>	<b>52,50</b>
	<b>LB1150017</b>	<b>40,50</b>		<b>LB1150021</b>	<b>47,00</b>		<b>LB1150025</b>	<b>52,50</b>
	<b>LB1150018</b>	<b>40,50</b>		<b>LB1150022</b>	<b>47,00</b>		<b>LB1150026</b>	<b>52,50</b>

**Box di derivazione Tag110/210**

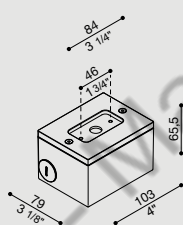

Box di derivazione per montaggio tag110/210 sporgente a parete (non per incasso). Corpo in alluminio pressofuso per il collegamento rapido con tubo rigido 20mm. Elevata resistenza all'ossidazione grazie al trattamento di passivazione a base di zirconio e alla verniciatura con resine poliestere stabilizzata ai raggi UV. Bulloneria in acciaio inox A4.

**Electrical junction box for fitting Tag 110/210** so that it projects from the wall (not flush fitting). Body made of die-cast aluminium for fast connection to the rigid 20 mm. pipe. Highly resistant to oxidization thanks to the zirconium based passivation process and the coating with UV-stabilised polyester resins. A4 stainless steel nuts and bolts.

**Box de dérivation pour montage tag110/210** en saillie sur le mur (ne peut pas être encastré dans le mur). Corps en aluminium moulé sous pression pour le raccord rapide avec tube rigide 20mm. Excellente résistance à l'oxydation grâce au traitement de passivation à base de zirconium et à la peinture avec résine polyester stabilisée aux rayons UV. Boulonnerie en acier inox A4.

COL.	CODE	€
	<b>LB1150007</b>	<b>46,00</b>
	<b>LB1150008</b>	<b>46,00</b>
	<b>LB1150009</b>	<b>46,00</b>
	<b>LB1150010</b>	<b>46,00</b>

**Adattatore albero**

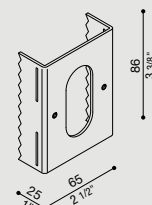

Adattatore per prodotti Ago, Tag e Noa in lamiera zincata per l'installazione su albero. Possibilità di installare più adattatori sullo stesso tronco. Abbinabile all'accessorio cinghia di fissaggio cod. LB1260019 (non inclusa).

**Adapter for tree installation** AGO/TAG/NOA adapter in galvanized plate for tree installation. Possibility to install several adapters on the same trunk. Combined with fixing strap accessory cod. LB1260019 (not included).

**Adaptateur pour les arbres** Adaptateur AGO/TAG/NOA en acier galvanisé pour l'installation sur les arbres. Possibilité d'installer plusieurs adaptateurs sur le même tronc. Peut être combiné avec la ceinture de fixation cod. LB1260019 (pas inclus).

COL.	CODE	€
	<b>LB1260018</b>	<b>17,50</b>

**Cinghia albero**

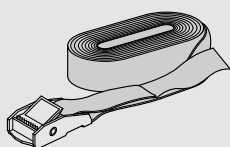

Cinghia albero lunghezza 6000 mm e larghezza 25 mm. Abbinabile all'adattatore albero cod. LB1260018 (non incluso).

**Tree belt** Tree belt 6000 mm length and 25 mm width. Combined with tree adapter cod. LB1260018 (not included).

**Ceinture pour arbre**, hauteur 6000 mm et largeur 25 mm. Peut-être combinée avec l'adaptateur d'arbre cod. LB1260018 (pas inclus).

COL.	CODE	€
	<b>LB1260019</b>	<b>31,00</b>



# Tag



Disponibile in diverse colorazioni.  
Available in different colours.  
Disponibile en différentes couleurs.



Tag 210 Power

**S** 27°

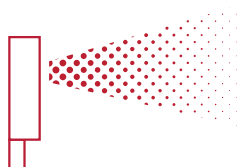

**A** Asimm.

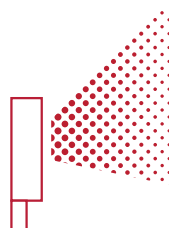

**W** 90°

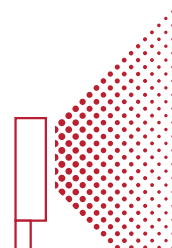



Tag 110/210 white

# Tag







Tag 210

Hippisch Centrum



Tag 210

# Kit Tag





**Outdoor  
e waterproof**



**Alimentazione diretta**

*Direct power supply  
Alimentation directe*



4



5

4 KIT TAG POST

5 KIT TAG GARDEN

# Kit Tag Box



**Kit-01:** composto da Tag 110 + Box di derivazione. Apparecchio inaccessibile, fornito con 1 m di cavo di alimentazione H05RN-F pre-cablato. Nessun rischio fotobiologico, RGO gruppo di rischio esente (EN62471).

**Kit-02:** composto da Tag 210 + Box di derivazione. Predisposto per doppio ingresso alimentazione. Fornito con 1 m di cavo di alimentazione H05RN-F pre-cablato. Nessun rischio fotobiologico nelle normali condizioni di impiego, RG1 gruppo di rischio basso (EN62471).

**Kit-03:** composto da Tag 210 asimmetrico + Box di derivazione. Predisposto per doppio ingresso alimentazione. Fornito con 1 m di cavo di alimentazione H05RN-F pre-cablato. Nessun rischio fotobiologico nelle normali condizioni di impiego, RG1 gruppo di rischio basso (EN62471).

Adatto anche ad uso esterno. Corpo, snodo e box in alluminio pressofuso; elevata resistenza all'ossidazione grazie al trattamento di passivazione a base di zirconio e alla verniciatura con resine poliestere stabilizzata ai raggi UV. Diffusore in vetro temperato e serigrafato. Riflettore in alluminio. Guarnizioni in silicone per mantenimento grado IP66. Bulloneria in acciaio inox A4. Regolazione inclinazione di 180°. **LED 4000K (N), 3000K (3) o 2700K (2). Alimentazione diretta 220-240V.**

**ENG Kit-01:** consisting of Tag 110 + electrical junction box. Inaccessible device, provided with 1m of prewired power cable H05RN-F. No risk of photobiological damage, RGO group (EN62471).

**Kit-02:** consisting of Tag210 + electrical junction box. Prearranged for double power input. Provided with 1m of prewired power cable H05RN-F. No photobiological risk under normal operating conditions, RG1 low risk group (EN62471).

**Kit-03:** consisting of assymetric Tag 210 + electrical junction box. Prearranged for double power input. Provided with 1m of prewired power cable H05RN-F. No photobiological risk under normal operating conditions, RG1 low risk group (EN62471).

Also suitable for outdoor use. Body, joint and box in die-cast aluminium highly resistant to oxidation thanks to the zirconium based passivation treatment and the UV stabilized polyester resin coating. Heat tempered and serigraphed glass diffuser. Aluminium reflector. Silicone gaskets to maintain IP66 rating. A4 stainless steel nuts and bolts. 180° angle adjustment.

**LED 4000K (N), 3000K (3) or 2700K (2). Integral ballast 220-240V.**

**FRA Kit-01 :** composé de Tag 110 + Box de dérivation. Appareil câble de usine, fourni avec 1m de câble d'alimentation H05RN-F-pré-cablé. Pas de risque photobiologique, RGO groupe (EN62471).

**Kit-02 :** composé de Tag 210 + Box de dérivation. Équipé d'une double entrée alimentation. Fourni avec 1m de câble d'alimentation H05RN-F-pré-cablé. Aucun risque photo biologique dans des conditions d'utilisation normales, RG1 groupe de risque bas (EN62471).

**Kit-03 :** composé de Tag 210 asymétrique + Box de dérivation. Équipé d'une double entrée alimentation. Fourni avec 1m de câble d'alimentation H05RN-F-pré-cablé. Aucun risque photo biologique dans des conditions d'utilisation normales, RG1 groupe de risque bas (EN62471). Peut être utilisé à l'extérieur. Corps, articulation et box en aluminium moulé sous pression; haute résistance à l'oxydation grâce au traitement de passivation à base de zirconium et laquage poudre à base de résines polyesters, fixées aux rayons UV. Diffuseur en verre trempé et sérigraphié. Réflecteur en aluminium. Joints en silicone pour maintenir degré IP66. Visserie en acier inox type A4. Réglage inclinaison de 180°.

**LED 4000K (N), 3000K (3) ou 2700K (2) (blanche chaude). Alimentation intégrée 220-240.**



### Kit-01 Tag 110 BOX

DIFF. TRASP.

IP 66 IP20 IK 06 1J xx3 CE UK CFA

LED	W	LM	REAL LM	COL.	CODE *	€	* LED COLOUR
10	1200	672	220-240 V		LL115008□	110,00	N 4000K
					LL115009□	110,00	3 3000K, Im -5%
					LL115010□	110,00	2 2700K, Im -5%
					LL115011□	110,00	

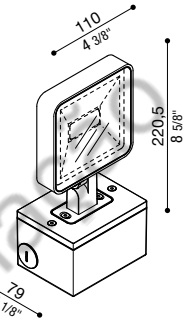

Kit composto dagli attuali codici KIT TAG 110 + LB1150007/8/9/10. Box IP20.

Kit consisting of the current codes KIT TAG 110 + LB1150007/8/9/10. Box IP20.

Kit composé des codes actuels KIT TAG 110 + LB1150007/8/9/10. Box IP20.

### Kit-02 Tag 210 BOX

DIFF. TRASP.

IP 66 IP20 IK 06 1J xx3 CE UK CFA

LED	W	LM	REAL LM	COL.	CODE *	€	* LED COLOUR
25	3500	2585	220-240 V		LL115012□	168,50	N 4000K
					LL115013□	168,50	3 3000K, Im -5%
					LL115014□	168,50	2 2700K, Im -5%
					LL115015□	168,50	

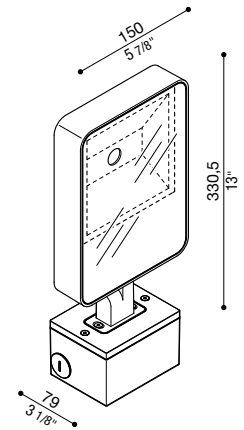

Kit composto dagli attuali codici KIT TAG 210 + LB1150007/8/9/10. Box IP20.

Kit consisting of the current codes KIT TAG 210 + LB1150007/8/9/10. Box IP20.

Kit composé des codes actuels KIT TAG 210 + LB1150007/8/9/10. Box IP20.

### Kit-03 Tag 210 asimmetrico BOX

DIFF. TRASP.

IP 66 IP20 IK 06 1J xx3 CE UK CFA

LED	W	LM	REAL LM	COL.	CODE *	€	* LED COLOUR
25	3500	2386	220-240 V		LL115016□	176,50	N 4000K
					LL115017□	176,50	3 3000K, Im -5%
					LL115018□	176,50	2 2700K, Im -5%
					LL115019□	176,50	

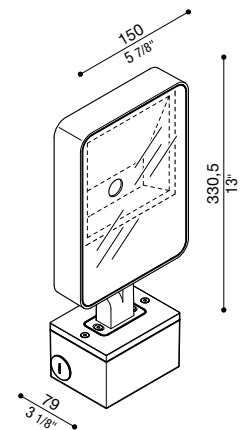

Kit composto dagli attuali codici TAG 210 ASIMMETRICO + LB1150007/8/9/10. Box IP20.

Kit consisting of the current codes TAG 210 ASIMMETRICO + LB1150007/8/9/10. Box IP20.

Kit composé des codes actuels TAG 210 ASIMMETRICO + LB1150007/8/9/10. Box IP20.

#### Finishing

□ Bianco RAL 9010 White RAL 9010 Blanc RAL 9010	■ Grigio antracite RAL 7021 Grey anthracite RAL 7021 Gris anthracite RAL 7021
■ Grigio High Tech RAL 9006 Grey High Tech RAL 9006 Gris High Tech RAL 9006	■ Corten Corten Corten

#### \* Led colour

- 4 4000K
- 7 3000K Im -5%
- N 3000K Im -5%

**Completa il codice**  
sostituendo al quadrato rosso la lettera o il numero corrispondente alla temperatura colore scelta.

**Complete the code**  
by replacing the red box with the letter or number corresponding to the selected colour temperature.

**Compléter le code**  
en remplaçant le carré rouge par la lettre ou le numéro correspondant à la sélection de température couleur.

#### ✓ Alimentatore integrato

Integrated driver  
Alimentation intégrée



# Kit Tag Garden



LED



**Anni di garanzia  
sul circuito LED**

Years warranty on LED circuit  
Ans de garantie sur la source LED



outdoor

**Kit-04:** composto da Tag 110 + Accessorio da giardino. Apparecchio inaccessibile, fornito con 1 m di cavo di alimentazione H05RN-F pre-cablato. Nessun rischio fotobiologico, RG0 gruppo di rischio esente (EN62471).

**Kit-05:** composto da Tag 210 + Accessorio da giardino. Predisposto per doppio ingresso alimentazione. Fornito con 1 m di cavo di alimentazione H05RN-F pre-cablato. Nessun rischio fotobiologico nelle normali condizioni di impiego, RG1 gruppo di rischio basso (EN62471).

**Kit-06:** composto da Tag 210 asimmetrico + Accessorio da giardino. Predisposto per doppio ingresso alimentazione. Fornito con 1 m di cavo di alimentazione H05RN-F pre-cablato. Nessun rischio fotobiologico nelle normali condizioni di impiego, RG1 gruppo di rischio basso (EN62471).

Adatto anche ad uso esterno. Corpo e snodo in alluminio pressofuso; elevata resistenza all'ossidazione grazie al trattamento di passivazione a base di zirconio e alla verniciatura con resine poliestere stabilizzata ai raggi UV. Diffusore in vetro temperato e serigrafato. Riflettore in alluminio. Guarnizioni in silicone per mantenimento grado IP66. Bulloneria in acciaio inox A4. Regolazione inclinazione di 180°. Accessorio da giardino da abbinare a Tag 110/210 realizzato in materiale termoplastico. Adatto per uso esterno, idoneo per installazione a terra. **LED 4000K (N), 3000K (3) o 2700K (2). Alimentazione diretta 220-240V.**

**ENG Kit-04:** consisting of Tag 110 + Garden accessory. Inaccessible device, provided with 1m of prewired power cable H05RN-F. No risk of photobiological damage, RG0 group (EN62471).

**Kit-05:** consisting of Tag 210 + Garden accessory. Prearranged for double power input. Provided with 1m of prewired power cable H05RN-F. No photobiological risk under normal operating conditions, RG1 low risk group (EN62471).

**Kit-06:** consisting of asymmetric Tag 210 + Garden accessory. Prearranged for double power input. Provided with 1m of prewired power cable H05RN-F. No photobiological risk under normal operating conditions, RG1 low risk group (EN62471). Also suitable for outdoor use. Die-cast aluminum Body and joint highly resistant to oxidation thanks to the zirconium based passivation treatment and the UV stabilized polyester resin coating. Heat tempered and serigraphed glass diffuser. Aluminum reflector. Silicone gaskets to maintain IP66 rating. A4 stainless steel nuts and bolts. 180° angle adjustment.

Thermoplastic garden accessory for Tag 110/ 210. Suitable for outdoor use and ground application.

**LED 4000K (N), 3000K (3) or 2700K (2). Integral ballast 220-240V.**

**FRA Kit-04 :** composé de Tag 110 + Accessoire de jardin. Appareil câble de usine, fourni avec 1m de câble d'alimentation H05RN-F-pré-cablé. Pas de risque photobiologique, RG0 groupe (EN62471).

**Kit-05 :** composé de Tag 210 + Accessoire de jardin. Équipé d'une double entrée alimentation. Fourni avec 1m de câble d'alimentation H05RN-F-pré-cablé. Aucun risque photo biologique dans des conditions d'utilisation normales, RG1 groupe de risque bas (EN62471).

**Kit-06 :** composé de Tag 210 asymétrique + Accessoire de jardin. Équipé d'une double entrée alimentation. Fourni avec 1m de câble d'alimentation H05RN-F-pré-cablé. Aucun risque photo biologique dans des conditions d'utilisation normales, RG1 groupe de risque bas (EN62471). Avec double entrée alimentation. Aucun risque photobiologique dans des conditions d'utilisation normales, RG1 groupe risque faible (EN62471). Peut être utilisé à l'extérieur. Corps et articulation en aluminium moulé sous pression; haute résistance à l'oxydation grâce au traitement de passivation à base de zirconium et laquage poudre à base de résines polyesters, fixées aux rayons UV. Diffuseur en verre trempé et sérigraphié. Réflecteur en aluminium. Joints en silicone pour maintenir degré IP66. Visserie en acier inox type A4. Réglage inclinaison de 180°. Accessoire de jardin en matériau thermoplastique à associer à Tag 110/ 210. Eglament adapté à l'usage " extérieur. Convient pour une utilisation au sol. **LED 4000K (N), 3000K (3) ou 2700K (2) (blanche chaud). Alimentation intégrée 220-240.**



### Kit 04 - Tag 110 Garden

DIFF. TRASP.

IP 66 IK 06 1J xx3 CE UK CA

LED	W	LM	REAL LM	COL.	CODE *	€	* LED COLOUR
	10	1200	672	☉	LL115026□	76,00	N 4000K
				☑	LL115027□	76,00	3 3000K, lm -5%
				☑	LL115028□	76,00	2 2700K, lm -5%
				☑	LL115029□	76,00	

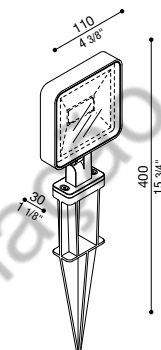

KIT composto da TAG 110 + LB1150035.

Kit consisting of TAG 110 + LB1150035.

Kit composé des TAG 110 + LB1150035.

### Kit 05 - Tag 210 Garden

DIFF. TRASP.

IP 66 IK 06 1J xx3 CE UK CA

LED	W	LM	REAL LM	COL.	CODE *	€	* LED COLOUR
	25	3500	2585	☉	LL115119□	134,50	N 4000K
				☑	LL115120□	134,50	3 3000K, lm -5%
				☑	LL115121□	134,50	2 2700K, lm -5%
				☑	LL115122□	134,50	

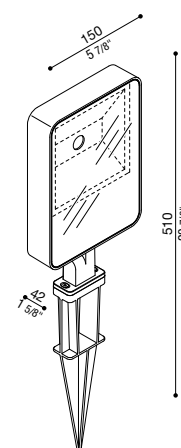

KIT composto da TAG 210 + LB1150035.

Kit consisting of TAG 210 + LB1150035.

Kit composé des TAG 210 + LB1150035.

### Kit 06 - Tag 210 Asimmetrico Garden

DIFF. TRASP.

IP 66 IK 06 1J xx3 CE UK CA

LED	W	LM	REAL LM	COL.	CODE *	€	* LED COLOUR
	25	3500	2386	☉	LL115123□	142,00	N 4000K
				☑	LL115124□	142,00	3 3000K, lm -5%
				☑	LL115125□	142,00	2 2700K, lm -5%
				☑	LL115126□	142,00	

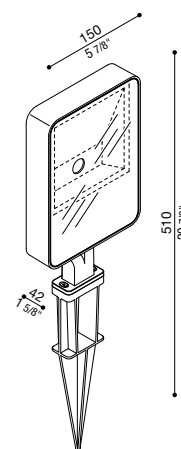

KIT composto da TAG 210 Asimmetrico + LB1150035.

Kit consisting of TAG 210 Asimmetrico + LB1150035.

Kit composé des TAG 210 Asimmetrico + LB1150035.

**Finishing**

□ Bianco RAL 9010 White RAL 9010 Blanc RAL 9010	□ Grigio antracite RAL 7021 Grey anthracite RAL 7021 Gris anthracite RAL 7021
□ Grigio High Tech RAL 9006 Grey High Tech RAL 9006 Gris High Tech RAL 9006	□ Corten Corten Corten

**\* Led colour**

4	4000K
7	3000K lm -5%
N	3000K lm -5%

**Completa il codice**  
sostituendo al quadrato rosso la lettera o il numero corrispondente alla temperatura colore scelta.

**Complete the code**  
by replacing the red box with the letter or number corresponding to the selected colour temperature.

**Compléter le code**  
en remplaçant le carré rouge par la lettre ou le numéro correspondant à la sélection de température couleur.

**✓ Alimentatore integrato**  
Integrated driver  
Alimentation intégrée

# Kit Tag Post



**Kit-07:** composto da Tag 110 + Adattatore palo post Ø 60. Apparecchio inaccessibile, fornito con 1 m di cavo di alimentazione H05RN-F pre-cablato. Nessun rischio fotobiologico, RG0 gruppo di rischio esente (EN62471).

**Kit-08:** composto da Tag 210 + Adattatore palo post Ø 60. Predisposto per doppio ingresso alimentazione. Fornito con 1 m di cavo di alimentazione H05RN-F pre-cablato. Nessun rischio fotobiologico nelle normali condizioni di impiego, RG1 gruppo di rischio basso (EN62471).

**Kit-09:** composto da Tag 210 asimmetrico + Adattatore palo post Ø 60. Predisposto per doppio ingresso alimentazione. Fornito con 1 m di cavo di alimentazione H05RN-F pre-cablato. Nessun rischio fotobiologico nelle normali condizioni di impiego, RG1 gruppo di rischio basso (EN62471).

Adatto anche ad uso esterno. Corpo e snodo in alluminio pressofuso; elevata resistenza all'ossidazione grazie al trattamento di passivazione a base di zirconio e alla verniciatura con resine poliestere stabilizzata ai raggi UV. Diffusore in vetro temperato e serigrafato. Riflettore in alluminio. Guarnizioni in silicone per mantenimento grado IP66. Bulloneria in acciaio inox A4. Regolazione inclinazione di 180°. Adattatore per installazione Tag110/210 su palo standard Ø60 mm. Corpo realizzato in alluminio pressofuso con elevata resistenza all'ossidazione, verniciato con resine di poliestere stabilizzate ai raggi UV. Bulloneria in acciaio inox A4. Palo post non incluso. **LED 4000K (N), 3000K (3) o 2700K (2). Alimentazione diretta 220-240V.**

**ENG Kit-07:** consisting of Tag 110 + Adaptor for Post Ø 60. Inaccessible device, provided with 1m of prewired power cable H05RN-F. No risk of photobiological damage, RG0 group (EN62471).

**Kit-08:** consisting of Tag210 + Adaptor for Post Ø 60. Prearranged for double power input. Provided with 1m of prewired power cable H05RN-F. No photobiological risk under normal operating conditions, RG1 low risk group (EN62471).

**Kit-09:** consisting of assymetric Tag 210 + Adaptor for Post Ø 60. Prearranged for double power input. Provided with 1m of prewired power cable H05RN-F. No photobiological risk under normal operating conditions, RG1 low risk group (EN62471).

Also suitable for outdoor use. Die-cast aluminum Body and joint highly resistant to oxidation thanks to the zirconium based passivation treatment and the UV stabilized polyester resin coating. Heat tempered and serigraphed glass diffuser. Aluminum reflector. Silicone gaskets to maintain IP66 rating. A4 stainless steel nuts and bolts. 180° angle adjustment. Adapter for installation Tag 110/210 on a standard post Ø60 mm. Die-cast alluminum Body, highly resistant to oxidation, coated with UV-stabilised polyester resins. A4 stainless steel nuts and bolts. Post not included. **LED 4000K (N), 3000K (3) or 2700K (2). Integral ballast 220-240V.**

**FRA Kit-07:** composé de Tag 110 + Adaptateur poteau Still Ø60. Appareil câble en usine, fourni avec 1m de câble d'alimentation H05RN-F-pré-cablé. Pas de risque photobiologique, RG0 groupe (EN62471).

**Kit-08:** composé de Tag 210 + Adaptateur poteau Still Ø60. Équipé d'une double entrée alimentation. Fourni avec 1m de câble d'alimentation H05RN-F-pré-cablé. Aucun risque photo biologique dans des conditions d'utilisation normales, RG1 groupe de risque bas (EN62471).

**Kit-09:** composé de Tag 210 asymétrique + Adaptateur poteau Still Ø60. Équipé d'une double entrée alimentation. Fourni avec 1m de câble d'alimentation H05RN-F-pré-cablé. Aucun risque photobiologique dans des conditions d'utilisation normales, RG1 groupe risque faible (EN62471). Peut être utilisé à l'extérieur. Corps et articulation en aluminium moulé sous pression; haute résistance à l'oxydation grâce au traitement de passivation à base de zirconium et laquage poudre à base de résines polyesters, fixées aux rayons UV. Diffuseur en verre trempé et sérigraphié. Réflecteur en aluminium. Joints en silicone pour maintenir degré IP66. Visserie en acier inox type A4. Réglage inclinaison de 180°. Adaptateur pour installation Tag110/210 sur poteau standard Ø60 mm. Corps réalisé en aluminium moulé sous pression avec excellente résistance à l'oxydation, peinture avec résines polyester stabilisées aux rayons UV. Boulonnerie en acier inox A4. Poteau non incluse. **LED 4000K (N), 3000K (3) ou 2700K (2) (blanche chaud). Alimentation intégrée 220-240.**



**Kit 07 - Tag 110 Post**

DIFF. TRASP.

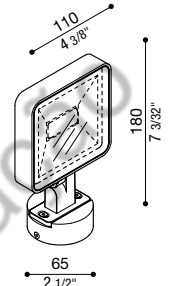

IP 66 IK 06 1J xx3 CE UK CA

LED	W	LM	REAL LM	COL.	CODE *	€	* LED COLOUR
10	1200	672	⊕ 220-240 V		LL115023□	76,00	N 4000K
					LL115024□	76,00	3 3000K, lm -5%
					LL115025□	76,00	2 2700K, lm -5%

KIT composto da TAG 110 + LB1150012/3/4.

Kit consisting of TAG 110 + LB1150012/3/4.

Kit composé des TAG 110 + LB1150012/3/4.

**Kit 08 - Tag 210 Post**

DIFF. TRASP.

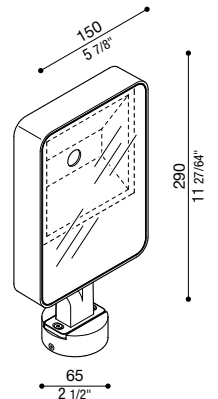

IP 66 IK 06 1J xx3 CE UK CA

LED	W	LM	REAL LM	COL.	CODE *	€	* LED COLOUR
25	3500	2585	⊕ 220-240 V		LL115113□	134,50	N 4000K
					LL115114□	134,50	3 3000K, lm -5%
					LL115115□	134,50	2 2700K, lm -5%

KIT composto da TAG 210 + LB1150012/3/4.

Kit consisting of TAG 210 + LB1150012/3/4.

Kit composé des TAG 210 + LB1150012/3/4.

**Kit 09 - Tag 210 Asimmetrico Post**

DIFF. TRASP.

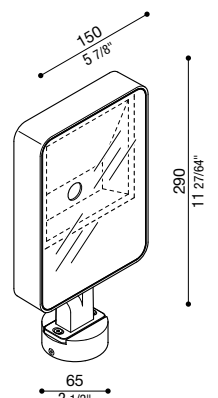

IP 66 IK 06 1J xx3 CE UK CA

LED	W	LM	REAL LM	COL.	CODE *	€	* LED COLOUR
25	3500	2386	⊕ 220-240 V		LL115116□	142,00	N 4000K
					LL115117□	142,00	3 3000K, lm -5%
					LL115118□	142,00	2 2700K, lm -5%

KIT composto da TAG 210 Asimmetrico + LB1150012/3/4.

Kit consisting of TAG 210 Asimmetrico + LB1150012/3/4.

Kit composé des TAG 210 Asimmetrico + LB1150012/3/4.

**Finishing**

	Grigio High Tech RAL 9006 Grey High Tech RAL 9006 Gris High Tech RAL 9006		Corten Corten Corten
	Grigio antracite RAL 7021 Grey anthracite RAL 7021 Gris anthracite RAL 7021		

**\* Led colour**

- 4 4000K
- 7 3000K lm -5%
- N 3000K lm -5%

**Completa il codice**  
sostituendo al quadrato rosso la lettera o il numero corrispondente alla temperatura colore scelta.

**Complete the code**  
by replacing the red box with the letter or number corresponding to the selected colour temperature.

**Compléter le code**  
en remplaçant le carré rouge par la lettre ou le numéro correspondant à la sélection de température couleur.

**Alimentatore integrato**  
Integrated driver  
Alimentation intégrée

# Kit Tag Braccetto



**Kit-10/11/12:** composto da Tag 110 + Braccetto. Apparecchio inaccessibile, fornito con 1 m di cavo di alimentazione H05RN-F pre-cablato. Nessun rischio fotobiologico, RG0 gruppo di rischio esente (EN62471).

**Kit-13/14/15:** composto da Tag 210 + Braccetto. Predisposto per doppio ingresso alimentazione. Fornito con 1 m di cavo di alimentazione H05RN-F pre-cablato. Nessun rischio fotobiologico nelle normali condizioni di impiego, RG1 gruppo di rischio basso (EN62471).

**Kit-16/17/18:** composto da Tag 210 asimmetrico + Braccetto. Predisposto per doppio ingresso alimentazione. Fornito con 1 m di cavo di alimentazione H05RN-F pre-cablato. Nessun rischio fotobiologico nelle normali condizioni di impiego, RG1 gruppo di rischio basso (EN62471).

Adatto anche ad uso esterno. Corpo e snodo in alluminio pressofuso; elevata resistenza all'ossidazione grazie al trattamento di passivazione a base di zirconio e alla verniciatura con resine poliestere stabilizzata ai raggi UV. Diffusore in vetro temperato e serigrafato. Riflettore in alluminio. Guarnizioni in silicone per mantenimento grado IP66. Bulloneria in acciaio inox A4. Regolazione inclinazione di 180°. Possibilità di installazione Tag 110/210 su palo, altezza: 500 mm – 300 mm – 160 mm, predisposto per installazione a pavimento e parete e soffitto. Palo in estruso di alluminio. Elevata resistenza all'ossidazione grazie al trattamento di passivazione a base di zirconio e alla verniciatura con resine poliestere stabilizzata ai raggi UV. Bulloneria in acciaio inox A4. Completo di kit di fissaggio e cavo tirante in acciaio. **LED 4000K (N), 3000K (3) o 2700K (2). Alimentazione diretta 220-240V.**

**ENG Kit-10/11/12:** consisting of Tag 110 + Bracket. Inaccessible device, provided with 1m of prewired power cable H05RN-F. No risk of photobiological damage, RG0 group (EN62471).

**Kit-13/14/15:** consisting of Tag 210 + Bracket. Prearranged for double power input. Provided with 1m of prewired power cable H05RN-F. No photobiological risk under normal operating conditions, RG1 low risk group (EN62471).

**Kit-16/17/18:** consisting of asymmetric Tag 210 + Bracket. Prearranged for double power input. Provided with 1m of prewired power cable H05RN-F. No photobiological risk under normal operating conditions, RG1 low risk group (EN62471). Also suitable for outdoor use. Die-cast aluminum Body and joint highly resistant to oxidation thanks to the zirconium based passivation treatment and the UV stabilized polyester resin coating. Heat tempered and serigraphed glass diffuser. Aluminum reflector. Silicone gaskets to maintain IP66 rating. A4 stainless steel nuts and bolts. 180° angle adjustment.

Possibility of installation Tag 110/210 on a post, height: 500 mm - 300 mm. - 160 mm., designed for floor, wall or ceiling installation. Post made of extruded aluminum. Highly resistant to oxidation thanks to the zirconium based passivation process and the coating with UV-stabilised polyester resins. A4 stainless steel nuts and bolts. Complete with fastening kit and stainless steel cable.

**LED 4000K (N), 3000K (3) or 2700K (2). Integral ballast 220-240V.**

**FRA Kit-10/11/12 :** composé de Tag 110 + Bras. Appareil inaccessible, fourni avec 1m de câble d'alimentation H05RN-F-pré-cablé. Pas de risque photobiologique, RG0 groupe (EN62471).

**Kit-13/14/15 :** composé de Tag 210 + Bras. Équipé d'une double entrée alimentation. Fourni avec 1m de câble d'alimentation H05RN-F-pré-cablé. Aucun risque photo biologique dans des conditions d'utilisation normales, RG1 groupe de risque bas (EN62471).

**Kit-16/17/18 :** composé de Tag 210 asymétrique + Bras. Équipé d'une double entrée alimentation. Fourni avec 1m de câble d'alimentation H05RN-F-pré-cablé. Aucun risque photo biologique dans des conditions d'utilisation normales, RG1 groupe de risque bas (EN62471). Avec double entrée alimentation. Aucun risque photobiologique dans des conditions d'utilisation normales, RG1 groupe risque faible (EN62471). Peut être utilisé à l'extérieur. Corps et articulation en aluminium moulé sous pression; haute résistance à l'oxydation grâce au traitement de passivation à base de zirconium et laquage poudre à base de résines polyester, fixées aux rayons UV. Diffuseur en verre trempé et sérigraphié. Réflecteur en aluminium. Joints en silicone pour maintenir degré IP66. Visserie en acier inox type A4. Réglage inclinaison de 180°. Possibilité d'installation Tag 110/210 sur poteau, hauteur : 500 mm – 300 mm – 160 mm, prévu pour installation au sol, au mur et au plafond. Poteau en aluminium extrudé. Excellente résistance à l'oxydation grâce au traitement de passivation à base de zirconium et à la peinture avec résines polyester stabilisées aux rayons UV. Boulonnerie en acier inox A4. Kit de fixation et tige en acier compris. **LED 4000K (N), 3000K (3) ou 2700K (2) (blanche chaud).**

**Alimentation intégrée 220-240.**





**Kit 10 - Tag 110 H160**

DIFF. TRASP.

IP 66 IK 06 1J xx3 CE UK CA

LED	W	LM	REAL LM	COL.	CODE *	€	* LED COLOUR
10	1200	672	⊕ 220-240 V		LL115030□	105,00	N 4000K
					LL115031□	105,00	3 3000K, Im -5%
					LL115032□	105,00	2 2700K, Im -5%
					LL115033□	105,00	

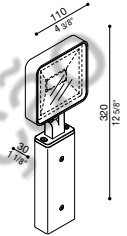

KIT composto da TAG 110 + LB1150015/6/7/8.

Kit consisting of TAG 110 + LB1150015/6/7/8.

Kit composé des TAG 110 + LB1150015/6/7/8.

**Kit 11 - Tag 110 H300**

DIFF. TRASP.

IP 66 IK 06 1J xx3 CE UK CA

LED	W	LM	REAL LM	COL.	CODE *	€	* LED COLOUR
10	1200	672	⊕ 220-240 V		LL115034□	111,50	N 4000K
					LL115035□	111,50	3 3000K, Im -5%
					LL115036□	111,50	2 2700K, Im -5%
					LL115037□	111,50	

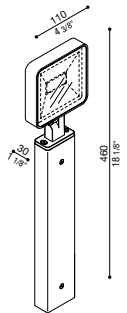

KIT composto da TAG 110 + LB1150019/20/21/22.

Kit consisting of TAG 110 + LB1150019/20/21/22.

Kit composé des TAG 110 + LB1150019/20/21/22.

**Kit 12 - Tag 110 H500**

DIFF. TRASP.

IP 66 IK 06 1J xx3 CE UK CA

LED	W	LM	REAL LM	COL.	CODE *	€	* LED COLOUR
10	1200	672	⊕ 220-240 V		LL115038□	117,00	N 4000K
					LL115039□	117,00	3 3000K, Im -5%
					LL115040□	117,00	2 2700K, Im -5%
					LL115041□	117,00	

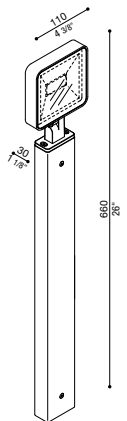

KIT composto da TAG 110 + LB1150023/4/5/6.

Kit consisting of TAG 110 + LB1150023/4/5/6.

Kit composé des TAG 110 + LB1150023/4/5/6.

**Finishing**

	Bianco RAL 9010 White RAL 9010 Blanc RAL 9010		Grigio antracite RAL 7021 Grey anthracite RAL 7021 Gris anthracite RAL 7021
	Grigio High Tech RAL 9006 Grey High Tech RAL 9006 Gris High Tech RAL 9006		Corten Corten Corten

**\* Led colour**

- 4 4000K
- 7 3000K Im -5%
- N 3000K Im -5%

**Completa il codice**  
sostituendo al quadrato rosso la lettera o il numero corrispondente alla temperatura colore scelta.

**Complete the code**  
by replacing the red box with the letter or number corresponding to the selected colour temperature.

**Compléter le code**  
en remplaçant le carré rouge par la lettre ou le numéro correspondant à la sélection de température couleur.

**Alimentatore integrato**  
Integrated driver  
Alimentation intégrée

# Kit Tag Braccetto

## Kit 13 - Tag 210 H160

DIFF.  
TRASP.

IP 66 IK 06 1J xx3 CE UK CA

LED	W	LM	REAL LM	COL.	CODE *	€	* LED COLOUR
	25	3500	2585	☉	LL115127□	164,00	N 4000K
				☑	LL115128□	164,00	3 3000K, lm -5%
				☑	LL115129□	164,00	2 2700K, lm -5%
				☑	LL115130□	164,00	

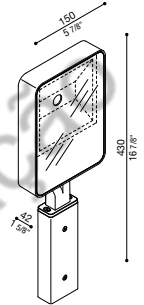

KIT composto da TAG 210 + LB1150015/6/7/8.

Kit consisting of TAG 210 + LB1150015/6/7/8.

Kit composé des TAG 210 + LB1150015/6/7/8.

## Kit 14 - Tag 210 H300

DIFF.  
TRASP.

IP 66 IK 06 1J xx3 CE UK CA

LED	W	LM	REAL LM	COL.	CODE *	€	* LED COLOUR
	25	3500	2585	☉	LL115135□	169,50	N 4000K
				☑	LL115136□	169,50	3 3000K, lm -5%
				☑	LL115137□	169,50	2 2700K, lm -5%
				☑	LL115138□	169,50	

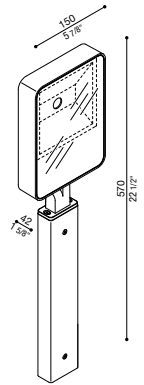

KIT composto da TAG 210 + LB1150019/20/21/22.

Kit consisting of TAG 210 + LB1150019/20/21/22.

Kit composé des TAG 210 + LB1150019/20/21/22.

## Kit 15 - Tag 210 H500

DIFF.  
TRASP.

IP 66 IK 06 1J xx3 CE UK CA

LED	W	LM	REAL LM	COL.	CODE *	€	* LED COLOUR
	25	3500	2585	☉	LL115143□	175,00	N 4000K
				☑	LL115144□	175,00	3 3000K, lm -5%
				☑	LL115145□	175,00	2 2700K, lm -5%
				☑	LL115146□	175,00	

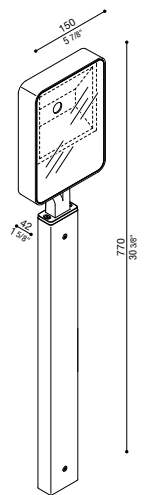

KIT composto da TAG 210 + LB1150023/4/5/6.

Kit consisting of TAG 210 + LB1150023/4/5/6.

Kit composé des TAG 210 + LB1150023/4/5/6.



### Kit 16 - Tag 210 Asimmetrico H160

DIFF.  
TRASP.

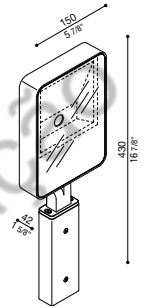

IP 66 IK 06 1J xx3 CE UK CA

LED	W	LM	REAL LM	COL.	CODE *	€	* LED COLOUR
	25	3500	2386	☉	LL115131□	171,50	N 4000K
				☑	LL115132□	171,50	3 3000K, Im -5%
				☑	LL115133□	171,50	2 2700K, Im -5%
				☑	LL115134□	171,50	

KIT composto da TAG 210 Asimmetrico + LB1150015/6/7/8.

Kit consisting of TAG 210 Asimmetrico + LB1150015/6/7/8.

Kit composé des TAG 210 Asimmetrico + LB1150015/6/7/8.

### Kit 17 - Tag 210 Asimmetrico H300

DIFF.  
TRASP.

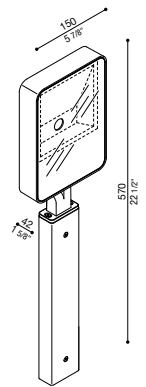

IP 66 IK 06 1J xx3 CE UK CA

LED	W	LM	REAL LM	COL.	CODE *	€	* LED COLOUR
	25	3500	2386	☉	LL115139□	177,50	N 4000K
				☑	LL115140□	177,50	3 3000K, Im -5%
				☑	LL115141□	177,50	2 2700K, Im -5%
				☑	LL115142□	177,50	

KIT composto da TAG 210 Asimmetrico + LB1150019/20/21/22.

Kit consisting of TAG 210 Asimmetrico + LB1150019/20/21/22.

Kit composé des TAG 210 Asimmetrico + LB1150019/20/21/22.

### Kit 18 - Tag 210 Asimmetrico H 500

DIFF.  
TRASP.

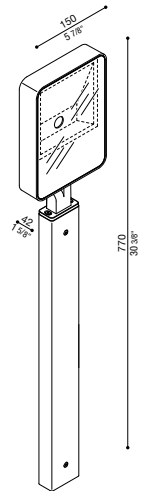

IP 66 IK 06 1J xx3 CE UK CA

LED	W	LM	REAL LM	COL.	CODE *	€	* LED COLOUR
	25	3500	2386	☉	LL115147□	183,00	N 4000K
				☑	LL115148□	183,00	3 3000K, Im -5%
				☑	LL115149□	183,00	2 2700K, Im -5%
				☑	LL115150□	183,00	

KIT composto da TAG 210 Asimmetrico + LB1150023/4/5/6.

Kit consisting of TAG 210 Asimmetrico + LB1150023/4/5/6.

Kit composé des TAG 210 Asimmetrico + LB1150023/4/5/6.

#### Finishing

Bianco RAL 9010 White RAL 9010 Blanc RAL 9010	Grigio antracite RAL 7021 Grey anthracite RAL 7021 Gris anthracite RAL 7021
Grigio High Tech RAL 9006 Grey High Tech RAL 9006 Gris High Tech RAL 9006	Corten Corten Corten

#### \* Led colour

- 4 4000K
- 7 3000K Im -5%
- N 3000K Im -5%

**Completa il codice**  
sostituendo al quadrato rosso la lettera o il numero corrispondente alla temperatura colore scelta.

**Complete the code**  
by replacing the red box with the letter or number corresponding to the selected colour temperature.

**Compléter le code**  
en remplaçant le carré rouge par la lettre ou le numéro correspondant à la sélection de température couleur.

☑ **Alimentatore integrato**  
Integrated driver  
Alimentation intégrée

# Kit Tag Side Post



**Kit-19:** composto da Tag 110 + Adattatore Laterale Palo Post Ø60 Tag. Apparecchio inaccessibile, fornito con 1 m di cavo di alimentazione H05RN-F pre-cablato. Nessun rischio fotobiologico, RG0 gruppo di rischio esente (EN62471).

**Kit-20:** composto da Tag 210 + Adattatore Laterale Palo Post Ø60 Tag. Predisposto per doppio ingresso alimentazione. Fornito con 1 m di cavo di alimentazione H05RN-F pre-cablato. Nessun rischio fotobiologico nelle normali condizioni di impiego, RG1 gruppo di rischio basso (EN62471).

**Kit-21:** composto da Tag 210 asimmetrico + Adattatore Laterale Palo Post Ø60 Tag. Predisposto per doppio ingresso alimentazione. Fornito con 1 m di cavo di alimentazione H05RN-F pre-cablato. Nessun rischio fotobiologico nelle normali condizioni di impiego, RG1 gruppo di rischio basso (EN62471).

Adatto anche ad uso esterno. Corpo e snodo in alluminio pressofuso; elevata resistenza all'ossidazione grazie al trattamento di passivazione a base di zirconio e alla verniciatura con resine poliestere stabilizzata ai raggi UV. Diffusore in vetro temperato e serigrafato. Riflettore in alluminio. Guarnizioni in silicone per mantenimento grado IP66. Adattatore in policarbonato nero per installazione laterale Tag 110/ Tag 210 su palo standard Ø 60 mm. Possibilità di regolare la rotazione dell'adattatore a 360°. Da abbinare a "Adattatore Palo Post Ø60 Tag" incluso, palo non incluso. **LED 4000K (N), 3000K (3) o 2700K (2). Alimentazione diretta 220-240V.**

**ENG Kit-19:** consisting of Tag 110 + Side Adaptor For Post Ø60 Tag. Inaccessible device, provided with 1m of prewired power cable H05RN-F. No risk of photobiological damage, RG0 group (EN62471).

**Kit-20:** consisting of Tag 210 + Side Adaptor For Post Ø60 Tag. Prearranged for double power input. Provided with 1m of prewired power cable H05RN-F. No photobiological risk under normal operating conditions, RG1 low risk group (EN62471).

**Kit-21:** consisting of assymetric Tag 210 + Side Adaptor For Post Ø60 Tag. Prearranged for double power input. Provided with 1m of prewired power cable H05RN-F. No photobiological risk under normal operating conditions, RG1 low risk group (EN62471). Also suitable for outdoor use. Die-cast aluminum Body and joint highly resistant to oxidation thanks to the zirconium based passivation treatment and the UV stabilized polyester resin coating. Heat tempered and serigraphed glass diffuser. Aluminum reflector. Silicone gaskets to maintain IP66 rating. A4 stainless steel nuts and bolts.

Adaptor in black polycarbonate fort Tag 110/ Tag 210 for side installation on standard post Ø 60mm. Adaptor 360° angle adjustment. To be combined with "Adaptor for Post Ø60 Tag" included, Post not included.

**LED 4000K (N), 3000K (3) or 2700K (2). Integral ballast 220-240V.**

**FRA Kit-19 :** composé de Tag 110 + Adaptateur Latéral Pour Poteau Post Ø 60 Tag. Appareil inaccessible, fourni avec 1m de câble d'alimentation H05RN-F-pré-cablé. Pas de risque photobiologique, RG0 groupe (EN62471).

**Kit-20 :** composé de Tag 210 + Adaptateur Latéral Pour Poteau Post Ø 60 Tag. Équipé d'une double entrée alimentation. Fourni avec 1m de câble d'alimentation H05RN-F-pré-cablé. Aucun risque photo biologique dans des conditions d'utilisation normales, RG1 groupe de risque bas (EN62471).

**Kit-21 :** composé de Tag 210 asymétrique + Adaptateur Latéral Pour Poteau Post Ø 60 Tag. Équipé d'une double entrée alimentation. Fourni avec 1m de câble d'alimentation H05RN-F-pré-cablé. Aucun risque photo biologique dans des conditions d'utilisation normales, RG1 groupe de risque bas (EN62471). Peut être utilisé à l'extérieur. Corps et articulation en aluminium moulé sous pression; haute résistance à l'oxydation grâce au traitement de passivation à base de zirconium et laquage poudre à base de résines polyesters, fixées aux rayons UV. Diffuseur en verre trempé et sérigraphié. Réflecteur en aluminium. Joints en silicone pour maintenir degré IP66. Visserie en acier inox type A4. Réglage inclinaison de 180°. Adaptateur en polycarbonate noir pour installation latérale sur poteau standard Ø60 mm. Possibilité de régler la rotation de l'adaptateur à 360°. Produit pour accompagner l'adaptateur 'Poteau Post Ø60 Tag' inclus, Post pas inclus.

**LED 4000K (N), 3000K (3) ou 2700K (2) (blanche chaud). Alimentation intégrée 220-240.**



**Kit 19 - Tag 110 Side**

DIFF. TRASP.

IP 66 IK 06 1J xx3 CE UK CA

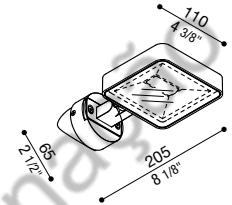

LED	W	LM	REAL LM	COL.	CODE *	€	* LED COLOUR
	10	1200	672	⊕ 220-240 V	LL115042□	88,00	N 4000K
					LL115043□	88,00	3 3000K, lm -5%
					LL115044□	88,00	2 2700K, lm -5%

Kit composto da TAG 110 + LB1150012/3/4 + LB1150036/7/8.

Kit consisting of TAG 110 + LB1150012/3/4 + LB1150036/7/8.

Kit composé des TAG 110 + LB1150012/3/4 + LB1150036/7/8.

**Kit 20 - Tag 210 Side**

DIFF. TRASP.

IP 66 IK 06 1J xx3 CE UK CA

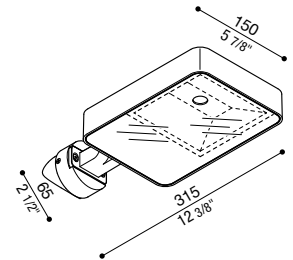

LED	W	LM	REAL LM	COL.	CODE *	€	* LED COLOUR
	25	3500	2585	⊕ 220-240 V	LL115151□	146,00	N 4000K
					LL115152□	146,00	3 3000K, lm -5%
					LL115153□	146,00	2 2700K, lm -5%

Kit composto da TAG 210 + LB1150012/3/4 + LB1150036/7/8.

Kit consisting of TAG 210 + LB1150012/3/4 + LB1150036/7/8.

Kit composé des TAG 210 + LB1150012/3/4 + LB1150036/7/8.

**Kit 21 - Tag 210 Asimmetrico Side**

DIFF. TRASP.

IP 66 IK 06 1J xx3 CE UK CA

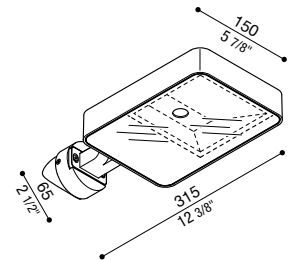

LED	W	LM	REAL LM	COL.	CODE *	€	* LED COLOUR
	25	3500	2386	⊕ 220-240 V	LL115154□	154,00	N 4000K
					LL115155□	154,00	3 3000K, lm -5%
					LL115156□	154,00	2 2700K, lm -5%

KIT composto da TAG 210 Asimmetrico + LB1150012/3/4 + LB1150036/7/8.

Kit consisting of TAG 210 Asimmetrico + LB1150012/3/4 + LB1150036/7/8.

Kit composé des TAG 210 Asimmetrico + LB1150012/3/4 + LB1150036/7/8.

**Finishing**

	Grigio High Tech RAL 9006 Grey High Tech RAL 9006 Gris High Tech RAL 9006		Corten Corten Corten
	Grigio antracite RAL 7021 Grey anthracite RAL 7021 Gris anthracite RAL 7021		

**\* Led colour**

- 4 4000K
- 7 3000K lm -5%
- N 3000K lm -5%

**Completa il codice**  
sostituendo al quadrato rosso la lettera o il numero corrispondente alla temperatura colore scelta.

**Complete the code**  
by replacing the red box with the letter or number corresponding to the selected colour temperature.

**Compléter le code**  
en remplaçant le carré rouge par la lettre ou le numéro correspondant à la sélection de température couleur.

**Alimentatore integrato**  
Integrated driver  
Alimentation intégrée



# Kit Tag



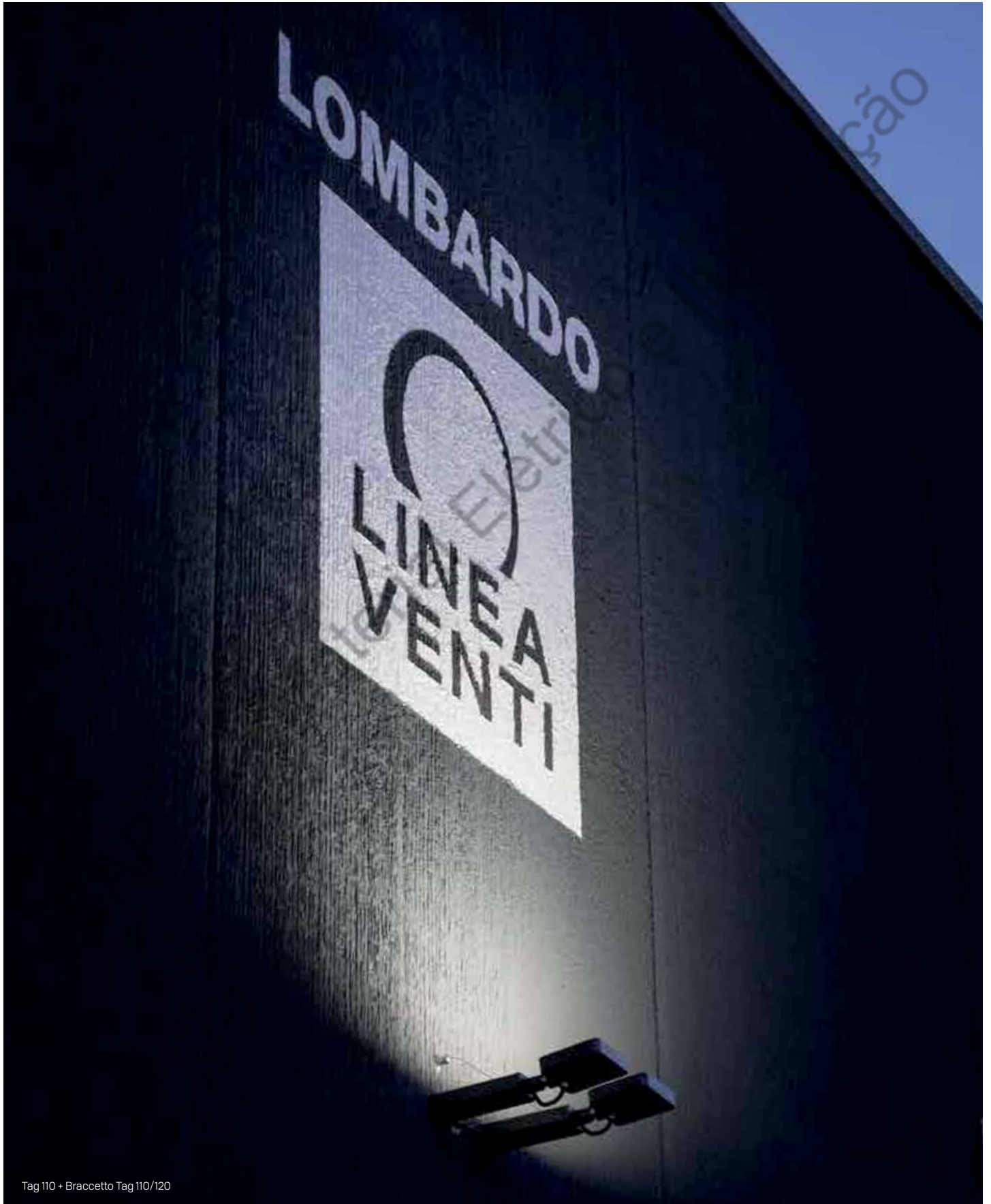



# Noa



LED

Material Eléctrico e Iluminación



indoor



outdoor

**ACCESSORI**

Accessories / Accessoires

Pag. 179



Adatto per uso esterno. Possibilità di installazione a parete, pavimento e soffitto. Corpo e snodo in alluminio pressofuso; elevata resistenza all'ossidazione grazie al trattamento di cataforesi e alla verniciatura con resine poliesteri stabilizzata ai raggi UV. Diffusore in vetro temprato e serigrafato. Riflettore in alluminio. Guarnizioni in silicone per il mantenimento del grado IP 66. Bulloneria in acciaio inox A4. Regolazione inclinazione di 90° e rotazione di 360°. LED a tensione di rete, dimmerabile a taglio di fase. Disponibile versione con filtro antiabbagliamento. Fornito di dispositivo di protezione alle sovratensioni (1KW).

**NOA 50 - 100:** forniti con pressacavo G1/2, valvola osmotica e tappo di chiusura. Modelli predisposti per doppio ingresso tubo. **LED 4000K (N), 3000K (3) e 2700 (2). LED a tensione di rete. Nessun rischio fotobiologico, RGO gruppo di rischio esente (EN62471).**

**ENG** Suitable for outdoor use. Possibility of wall, floor and ceiling installation. Die-cast aluminum body and stem; high resistance to oxidation thanks to cataphoresis treatment and UV-stabilized polyester resin coating. Tempered and screen-printed glass diffuser. Aluminum reflector. Silicone gaskets to maintain the IP 66 degree. Stainless steel A4 bolts. 90° inclination adjustment and 360° rotation. LED AC Direct, phase cut dimmable. Version with anti-glare filter available. Equipped with overvoltage protection device (1KW).

**NOA 50 - 100:** supplied with G1/2 cable gland, osmotic valve and closing cap. Models suitable for inline wiring. **LED 4000K (N), 3000K (3) or 2700K (2). LED AC Direct. No risk of photobiological damage, RGO group (EN62471).**

**FRA** Adapté à l'usage à l'extérieur. Possibilité d'installation au mur, au sol et au plafond. Corps et tige en aluminium injecté; haute résistance à l'oxydation grâce au traitement de cataphorèse et laquage poudre à base de résines polyesters, fixées aux rayons UV. Diffuseur en verre trempé et sérigraphié. Réflecteur en aluminium. Joints en silicone pour maintenir le degré IP 66. Visserie en acier inoxydable A4. Réglage de l'inclinaison à 90° et rotation à 360°. LED direct 220-240 V, dimmable coupure de phase. Version disponible avec filtre anti-reflet. Equipé d'un dispositif de protection contre les surtensions (1KW).

**NOA 50 - 100:** livré avec un presse-étoupe G1/2, une valve osmotique et un bouchon de fermeture. Prédiposition pour alimentation à double entrée. **LED 4000K (N), 3000K (3) ou 2700K (2) (blanche chaud). LED Direct 220-240 V. Pas de risque photobiologique, RGO groupe (EN62471).**

**Noa 50**



**Noa 100**



**Noa 50 Wall**



**Noa 100 Wall**



**Noa 50 Top**



**Noa 100 Top**



**Dimmerabile**  
Dimmable  
Dimmable



**Cataforesi**  
Cataphoresis  
Cataphorèse



**Honeycomb**



**Outdoor  
e waterproof**



**Anni di garanzia  
sul circuito LED**  
Years warranty on LED circuit  
Ans de garantie sur la source LED

# Noa



1 NOA WALL

2 NOA TOP





3

# Noa

## Noa 50

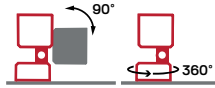

DIFF.  
TRASP.

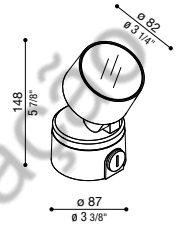

IP66 IK10 20J xx9 CE UK CRA

LED	W	LM	REAL LM	COL.	CODE **	€	* OPTIC	* LED COLOUR
9	1000	750	AC DIRECT		LL133000	116,00	D Diff.	N 4000K
					LL133001	116,00	S 25°	3 3000K, Im -5%
					LL133002	116,00	M 40°	2 2700K, Im -5%
					LL133003	116,00	L 60°	
					LL133004	116,00		
9	1000	500	AC DIRECT		LL133005	124,50		
					LL133006	124,50		
					LL133007	124,50		
					LL133008	124,50		
					LL133009	124,50		

Possibile scelta di 3 differenti ottiche. Versione Honeycomb non disponibile con ottica D.

Choice of 3 different optics. Optic D not available for Honeycomb version.

Choix possible de 3 optiques différentes. Optique D non disponible pour la version Honeycomb.

## Noa 100

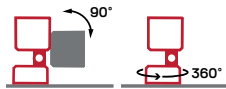

DIFF.  
TRASP.

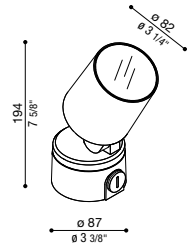

IP66 IK10 20J xx9 CE UK CRA

LED	W	LM	REAL LM	COL.	CODE **	€	* OPTIC	* LED COLOUR
16	1750	1200	AC DIRECT		LL133010	127,50	D Diff.	N 4000K
					LL133011	127,50	S 25°	3 3000K, Im -5%
					LL133012	127,50	M 40°	2 2700K, Im -5%
					LL133013	127,50	L 60°	
					LL133014	127,50		
16	1750	800	AC DIRECT		LL133015	135,50		
					LL133016	135,50		
					LL133017	135,50		
					LL133018	135,50		
					LL133019	135,50		

Possibile scelta di 3 differenti ottiche. Versione Honeycomb non disponibile con ottica D.

Choice of 3 different optics. Optic D not available for Honeycomb version.

Choix possible de 3 optiques différentes. Optique D non disponible pour la version Honeycomb.

### Finishing

	Bianco RAL 9010 White RAL 9010 Blanc RAL 9010		Corten Corten Corten
	Grigio High Tech RAL 9006 Grey High Tech RAL 9006 Gris High Tech RAL 9006		Verde RAL 6003 Green RAL 6003 Vert RAL 6003
	Grigio antracite RAL 7021 Grey antracite RAL 7021 Gris antracite RAL 7021		

✓ Alimentatore integrato  
Integrated driver  
Alimentation intégrée



Versione HONEYCOMB  
HONEYCOMB version  
Version HONEYCOMB



### Noa 50 Wall

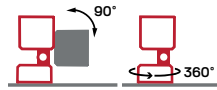

DIFF. TRASP.

IP 66 IK 10 20J xx9 CE UK CRA

LED	W	LM	REAL LM	COL.	CODE **	€	* OPTIC	* LED COLOUR
9	1000	750	AC DIRECT		LL133020□□	104,00	D Diff.	N 4000K
					LL133021□□	104,00	S 25°	3 3000K, Im -5%
					LL133022□□	104,00	M 40°	2 2700K, Im -5%
					LL133023□□	104,00	L 60°	
					LL133024□□	104,00		
9	1000	500	AC DIRECT		LL133025□□	112,50		
					LL133026□□	112,50		
					LL133027□□	112,50		
					LL133028□□	112,50		
					LL133029□□	112,50		

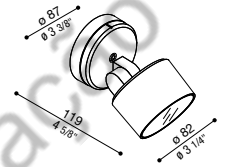

Possibile scelta di 3 differenti ottiche. Versione Honeycomb non disponibile con ottica D.

Choice of 3 different optics. Optic D not available for Honeycomb version.

Choix possible de 3 optiques différentes. Optique D non disponible pour la version Honeycomb.

### Noa 100 Wall

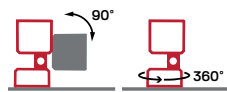

DIFF. TRASP.

IP 66 IK 10 20J xx9 CE UK CRA

LED	W	LM	REAL LM	COL.	CODE **	€	* OPTIC	* LED COLOUR
16	1750	1200	AC DIRECT		LL133030□□	116,00	D Diff.	N 4000K
					LL133031□□	116,00	S 25°	3 3000K, Im -5%
					LL133032□□	116,00	M 40°	2 2700K, Im -5%
					LL133033□□	116,00	L 60°	
					LL133034□□	116,00		
16	1750	800	AC DIRECT		LL133035□□	124,50		
					LL133036□□	124,50		
					LL133037□□	124,50		
					LL133038□□	124,50		
					LL133039□□	124,50		

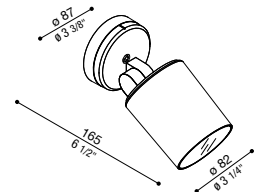

Possibile scelta di 3 differenti ottiche. Versione Honeycomb non disponibile con ottica D.

Choice of 3 different optics. Optic D not available for Honeycomb version.

Choix possible de 3 optiques différentes. Optique D non disponible pour la version Honeycomb.

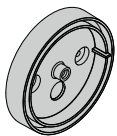

Disponibile base Noa Wall verniciata.  
Painted Noa Wall base available.  
Disponible base Noa Wall peint.

**\* Led colour** **Completa il codice** **Complete the code** **Compléter le code**  
 N 4000K sostituendo al quadrato rosso la lettera o il numero corrispondente alla temperatura colore scelta.  
 3 3000K, Im -5% by replacing the red box with the letter or number corresponding to the selected colour temperature.  
 2 2700K, Im -5% en remplaçant le carré rouge par la lettre ou le numéro correspondant à la sélection de température couleur.







**\* Optic** **Completa il codice** **Complete the code** **Compléter le code**  
 □ sostituendo al quadrato grigio la lettera corrispondente al modello di ottica scelta.  
 by replacing the grey box with the letter corresponding to the selected optic model.  
 en remplaçant le carré gris par la lettre correspondante au modèle de lentille choisie.

# Noa

## Noa 50 Top

DIFF.  
TRASP.

IP 66 IK 10 20J xx9   

LED	W	LM	REAL LM	COL.	CODE **	€	* OPTIC	* LED COLOUR
9	1000	750	  AC DIRECT		LL133040□□	92,00	D Diff. S 25° M 40° L 60°	N 4000K 3 3000K, Im -5% 2 2700K, Im -5%
					LL133041□□	92,00		
					LL133042□□	92,00		
					LL133043□□	92,00		
9	1000	500	  AC DIRECT 		LL133044□□	100,50		
					LL133045□□	100,50		
					LL133046□□	100,50		
					LL133047□□	100,50		

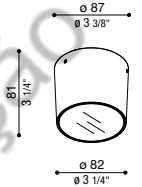

Possibile scelta di 3 differenti ottiche. Versione Honeycomb non disponibile con ottica D.







Choice of 3 different optics. Optic D not available for Honeycomb version.

Choix possible de 3 optiques différentes. Optique D non disponible pour la version Honeycomb.

## Noa 100 Top

DIFF.  
TRASP.

IP 66 IK 10 20J xx9   

LED	W	LM	REAL LM	COL.	CODE **	€	* OPTIC	* LED COLOUR
16	1750	1200	  AC DIRECT		LL133048□□	104,00	D Diff. S 25° M 40° L 60°	N 4000K 3 3000K, Im -5% 2 2700K, Im -5%
					LL133049□□	104,00		
					LL133050□□	104,00		
					LL133051□□	104,00		
16	1750	800	  AC DIRECT 		LL133052□□	112,50		
					LL133053□□	112,50		
					LL133054□□	112,50		
					LL133055□□	112,50		

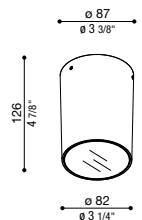





Possibile scelta di 3 differenti ottiche. Versione Honeycomb non disponibile con ottica D.

Choice of 3 different optics. Optic D not available for Honeycomb version.

Choix possible de 3 optiques différentes. Optique D non disponible pour la version Honeycomb.

### Finishing

	Bianco RAL 9010 White RAL 9010 Blanc RAL 9010		Corten Corten Corten
	Grigio High Tech RAL 9006 Grey High Tech RAL 9006 Gris High Tech RAL 9006		Verde RAL 6003 Green RAL 6003 Vert RAL 6003
	Grigio antracite RAL 7021 Grey anthracite RAL 7021 Gris anthracite RAL 7021		

 Alimentatore integrato  
Integrated driver  
Alimentation intégrée



Versione HONEYCOMB  
HONEYCOMB version  
Version HONEYCOMB



**ACCESSORI**

Accessories / Accessoires

**Kit gel bicomponente**

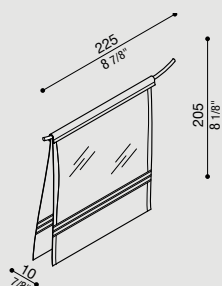

Per modelli NOA 50 e NOA 100.  
Gel silconico riaccessibile, riempitivo e isolante.

**Kit Gel**  
For NOA 50 and NOA 100 models  
Re-accessible silicone gel, filler  
and insulator.

Pour les modèles NOA 50 et  
NOA 100. Gel en silicone de  
remplissage, isolant et ré-  
accessible.

COL.	CODE	€
	<b>LB1330001</b>	<b>15,50</b>

**Cinghia albero**

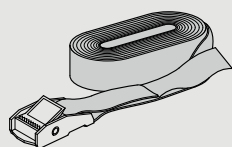

Cinghia albero lunghezza 6000 mm e larghezza 25 mm.  
Abbinabile all'adattatore albero cod. LB1260018 (non incluso).

**Tree belt**  
Tree belt 6000 mm length and 25  
mm width.  
Combined with tree adapter cod.  
LB1260018 (not included).

Ceinture pour arbre, hauteur 6000  
mm et largeur 25 mm.  
Peut-être combinée avec  
l'adaptateur d'arbre cod.  
LB1260018 (pas inclus).

COL.	CODE	€
	<b>LB1260019</b>	<b>31,00</b>

**Adattatore albero**

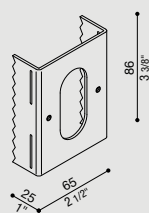

Adattatore per prodotti Ago, Tag e Noa in lamiera zincata per l'installazione su albero.  
Possibilità di installare più adattatori sullo stesso tronco.  
Abbinabile all'accessorio cinghia di fissaggio cod. LB1260019 (non inclusa).

**Adapter for tree installation**  
AGO/TAG/NOA adapter in  
galvanized plate for tree  
installation.  
Possibility to install several  
adapters on the same trunk.  
Combined with fixing strap  
accessory cod. LB1260019 (not  
included).

**Adaptateur pour les arbres**  
Adaptateur AGO/TAG/NOA en  
acier galvanisé pour l'installation  
sur les arbres.  
Possibilité d'installer plusieurs  
adaptateurs sur le même tronc.  
Peut être combiné avec la ceinture  
de fixation cod. LB1260019 (pas  
inclus).

COL.	CODE	€
	<b>LB1260018</b>	<b>17,50</b>

**Accessorio giardino**

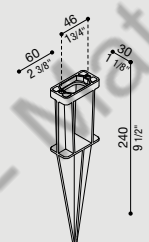

Accessorio da giardino realizzato in materiale termoplastico. Adatto per uso esterno, idoneo per installazione a terra.

**Garden accessory**  
Thermoplastic garden accessory.  
Suitable for outdoor use and  
ground application.

**Accessoire de jardin**  
Accessoire de jardin en matériau  
thermoplastique. Eglament adapté  
à l'usage à l'extérieur. Convient  
pour une utilisation au sol.

COL.	CODE	€
	<b>LB1150035</b>	<b>11,50</b>

**Base Noa Wall verniciata**

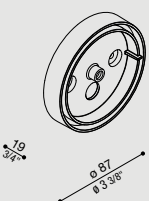

Base Noa Wall verniciata

Painted Noa Wall base

Base Noa Wall peint

COL.	CODE	€
	<b>LB1330011</b>	<b>11,50</b>
	<b>LB133001G</b>	<b>11,50</b>
	<b>LB133001E</b>	<b>11,50</b>
	<b>LB133001K</b>	<b>11,50</b>
	<b>LB133001V</b>	<b>11,50</b>

**\* Led colour**

**Completa il codice**

sostituendo al quadrato rosso la lettera o il numero corrispondente alla temperatura colore scelta.

**Complete the code**

by replacing the red box with the letter or number corresponding to the selected colour temperature.

**Compléter le code**

en remplaçant le carré rouge par la lettre ou le numéro correspondant à la sélection de température couleur.

- N** 4000K
- 3** 3000K, Im -5%
- 2** 2700K, Im -5%

**\* Optic**



**Completa il codice**

sostituendo al quadrato grigio la lettera corrispondente al modello di ottica scelta.

**Complete the code**

by replacing the grey box with the letter corresponding to the selected optic model.

**Compléter le code**

en remplaçant le carré gris par la lettre correspondante au modèle de lentille choisie.



# Noa



#### Possibilità di montaggio NOA:

- 1 - direttamente a terra
- 2 - tubo in metallo
- 3 - tubo in plastica
- 4 - cavo diretto
- 5 - tubo corrugato

#### Nella confezione NOA sono compresi:

1 base, 1 valvola osmotica, 1 tappo di chiusura, 1 pressacavo G1/2.

#### NOA installation possibilities:

- 1 - directly to the ground
- 2 - metal tube
- 3 - plastic tube
- 4 - direct cable
- 5 - corrugated tube

#### The NOA package includes:

1 base, 1 osmotic valve, 1 closing cap, 1 G1/2 cable gland.

#### Possibilit  de montage NOA:

- 1 - directement au sol
- 2 - tube m tallique
- 3 - tube en plastique
- 4 - c ble direct
- 5 - tube ondul 

#### L'emballage NOA comprend:

1 base, 1 valve osmotique, 1 bouchon de fermeture, 1 presse- toupes G1/2.



Versione HONEYCOMB.  
HONEYCOMB version.  
Version HONEYCOMB  
(nid d'abeille).



Gel silicónico riaccessibile,  
riempitivo e isolante (non incluso).

Re-accessible silicone gel, filler  
and insulator (not included).

Gel en silicone de remplissage,  
isolant et ré-accessible (pas  
inclus).



Stelo graduato per regolare  
perfettamente l'inclinazione  
del fascio luminoso.

Graduated stem to perfectly  
adjust the inclination of the  
light beam.

Tige graduée pour régler  
parfaitement l'angle du  
faisceau lumineux.



Base graduata per regolare la  
rotazione del fascio luminoso.

Graduated base to adjust the  
rotation of the light beam.

Base graduée pour régler  
la rotation du faisceau  
lumineux.



### Vetri colorati

A richiesta, disponibili versioni con  
filtro colorato: rosso, verde e blu.  
(Sovraprezzo: + 9,00 € di listino)

On request, versions with colored  
filters available: red, green and blue.  
(Extra charge: + 9,00 € list price)

Sur demande, des versions avec  
filtre coloré sont disponibles:  
rouge, vert et bleu. (Supplément:  
+ 9,00 € prix de liste)



# Noa





Noa 50



Noa 50 wall



# Noa

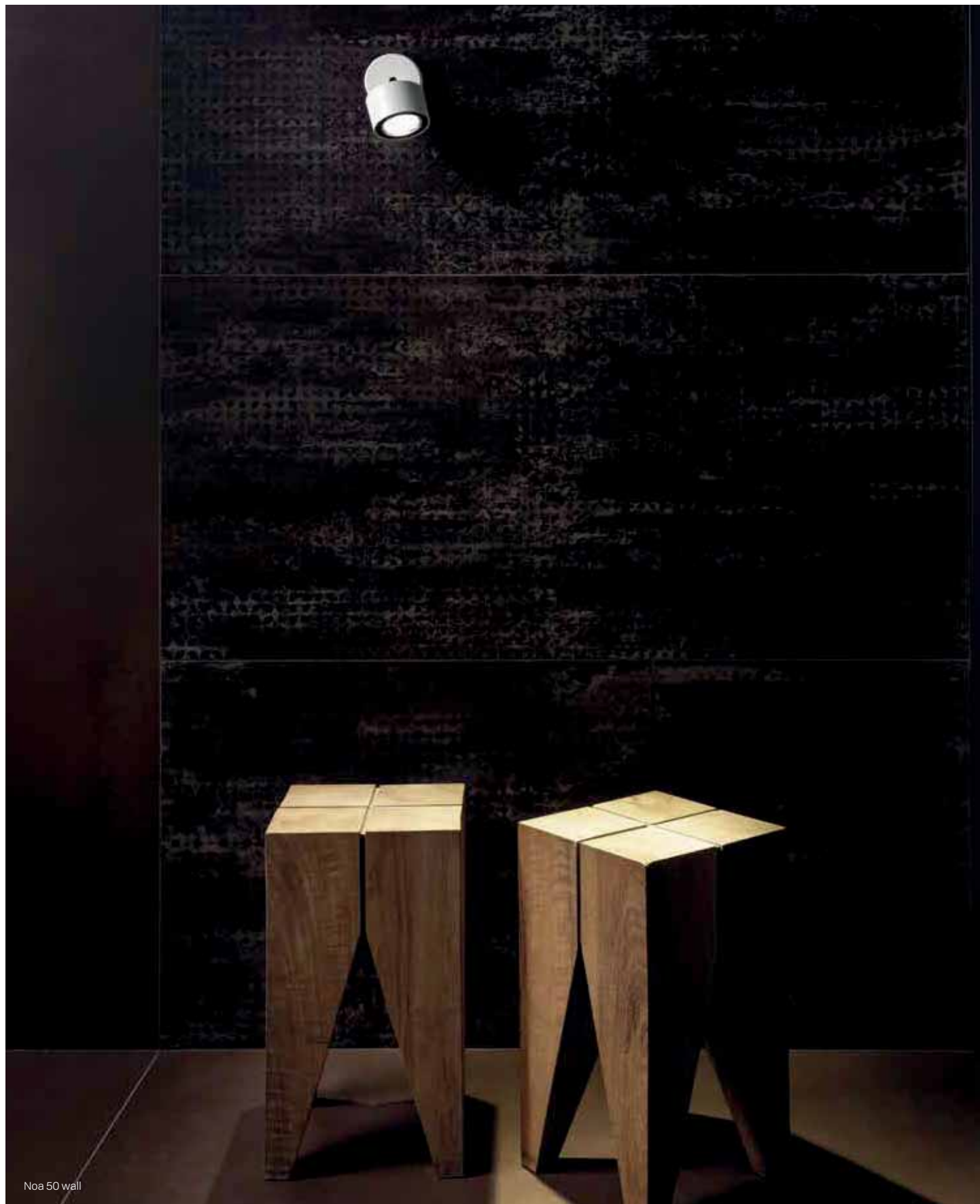





Noa 50 top



Noa 100



# Noa



Noa 50





Noa 50

# Ago



LED



1



2



3



4



indoor



outdoor



5



6

1 AGO  
APPLIQUE

2 AGO  
WALL

3 AGO  
WALL POWER

4 AGO  
TOP

5 AGO  
GARDEN

6 AGO  
GARDEN POWER



7



# Ago

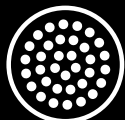

LED



outdoor

**ACCESSORI**

Accessories / Accessoires

Pag. 194



Adatto per installazione a terra ed uso esterno.

Corpo in alluminio anodizzato EN-6026; elevata resistenza all'ossidazione grazie al trattamento di anodizzazione. Diffusore in vetro temprato e serigrafato.

Apparecchio inaccessibile fornito con 1 m di cavo di alimentazione H05RN-F pre-cablato e resinato.

Bulloneria in acciaio inox A4 o AISI 316L. Disponibile versione LED a tensione di rete, dimmerabile a taglio di fase.

Disponibile versione 24V.

**LED 4000K (N), 3000K (3), o 2700K (2). Nessun rischio fotobiologico, RGO gruppo di rischio esente (EN62471).**

**ENG** Suitable for ground installation and for outdoor use.

Body made of EN-6026 anodized aluminum; highly resistant to oxidation due to anodizing treatment.

Heat tempered and silk-screen printed glass.

Inaccessible device, provided with 1 m prewired power cable HORN-F

with epoxy resin treatment. A4 or AISI 316L stainless steel nuts and bolts.

Available LED AC direct, phase cut dimmable. Available 24V version.

**LED 4000K (N), 3000K (3) or 2700K (2). No risk of photobiological damage, RGO group (EN62471).**

**FRA** Adapté pour une installation au sol et pour l'usage à l'extérieur.

Corps en aluminium EN-6026 anodisé, haute résistance à l'oxydation grâce au traitement d'anodisation. Diffuseur en verre trempé et sérigraphié. Appareil câblé en usine, fourni avec 1 m de câble d'alimentation H05RN-F pré-câblé et résiné.

Visserie en acier inox type A4 ou AISI 316L.

Disponible en LED AC direct 220-240V, dimmable coupure de phase.

Disponible en version 24V.

**LED 4000K (N), 3000K (3) ou 2700K (2) (blanche chaud). Pas de risque photobiologique, RGO groupe (EN62471).**

#### Ago Garden



#### Ago Garden Power



**Outdoor  
e waterproof**



#### Ago Wall



#### Ago Wall Power



**Anodizzazione**  
Anodisation  
Anodisation



**Dimmerabile**  
Dimmable  
Dimmable



**Pre-cablato**  
Pre-wired  
Pré-câblé



**Anni di garanzia  
sul circuito LED**  
Years warranty on LED circuit  
Ans de garantie sur la source LED

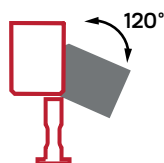

Regolazione inclinazione 120°.  
120° angle adjustment.  
Réglage inclinaison de 120°.

# Ago

## Ago Garden

DIFF.  
TRASP.

IP66 IK 07 2J xx5 CE UK  
CA

LED	W	LM	REAL LM	COL.	CODE **	€	* OPTIC	* LED COLOUR
6	700	568	AC DIRECT	LL126000	103,00	D Diff. S 25° M 40° L 65°	N 4000K 3 3000K, lm -5% 2 2700K, lm -5%	
				LL126001	103,00			
				LL126002	103,00			
				LL126003	103,00			
6	700	568	24V	LT126000	110,00			
				LT126001	110,00			
				LT126002	110,00			
				LT126003	110,00			

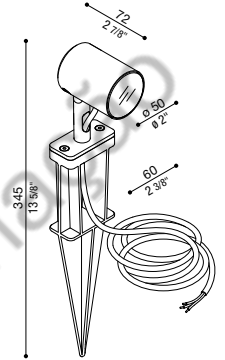

Idoneo per installazione a terra.

Suitable for ground installation.

Convient pour une utilisation au sol.

## Ago Garden Power

DIFF.  
TRASP.

IP66 IK 07 2J xx5 CE UK  
CA

LED	W	LM	REAL LM	COL.	CODE **	€	* OPTIC	* LED COLOUR
10	1100	933	AC DIRECT	LL126100	114,50	D Diff. S 25° M 40° L 65°	N 4000K 3 3000K, lm -5% 2 2700K, lm -5%	
				LL126101	114,50			
				LL126102	114,50			
				LL126103	114,50			
10	1100	933	24V	LT126100	121,50			
				LT126101	121,50			
				LT126102	121,50			
				LT126103	121,50			

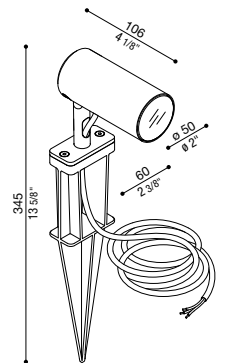

Idoneo per installazione a terra.

Suitable for ground installation.

Convient pour une utilisation au sol.

## Ago Wall

DIFF.  
TRASP.

IP66 IK 07 2J xx5 CE UK  
CA

LED	W	LM	REAL LM	COL.	CODE **	€	* OPTIC	* LED COLOUR
6	700	568	AC DIRECT	LL126004	118,00	D Diff. S 25° M 40° L 65°	N 4000K 3 3000K, lm -5% 2 2700K, lm -5%	
				LL126005	118,00			
				LL126006	118,00			
				LL126007	118,00			
6	700	568	24V	LT126004	125,50			
				LT126005	125,50			
				LT126006	125,50			
				LT126007	125,50			

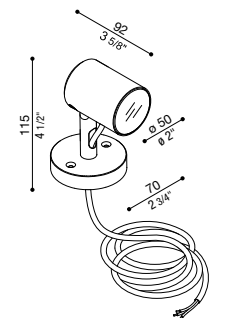

Idoneo per installazioni a parete e soffitto.

Suitable for wall and ceiling installation.

Adapté pour les installations murales et au plafond.



## Ago Wall Power

DIFF. TRASP.

IP66 IK07 2J xx5 CE UK CA

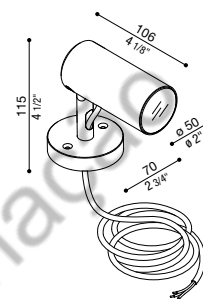

LED	W	LM	REAL LM	COL.	CODE **	€	* OPTIC	* LED COLOUR
10	1100	933	AC DIRECT	Grey	LL126104	129,50	D Diff.	N 4000K
				Black	LL126105	129,50	S 25°	3 3000K, Im -5%
				Green	LL126106	129,50	M 40°	2 2700K, Im -5%
				Brown	LL126107	129,50	L 65°	
				Grey	LT126104	137,00		
10	1100	933	24V	Black	LT126105	137,00		
				Green	LT126106	137,00		
				Brown	LT126107	137,00		
				Grey				

Idoneo per installazioni a parete e soffitto.

Suitable for wall and ceiling installation.

Adapté pour les installations murales et au plafond.



Colori disponibili.  
Available colours.  
Couleurs disponibles.

- Alluminio Anodizzato Grigio  
Grey Anodized Aluminum  
Aluminium anodisé Gris
- Alluminio Anodizzato Verde  
Green Anodized Aluminum  
Aluminium anodisé Vert
- Alluminio Anodizzato Nero  
Black Anodized Aluminum  
Aluminium anodisé Noir
- Alluminio Anodizzato Marrone  
Brown Anodized Aluminum  
Aluminium anodisé Marron

## ACCESSORI

Accessories / Accessoires

### Cannocchiale Asimmetrico Ago

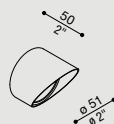

Cannocchiale asimmetrico antiabbagliamento.

**Asymmetrical snoot Ago**  
Asymmetrical snoot anti-glare.

**Casquette asymétrique Ago**  
Casquette asymétrique antiéblouissement.

COL.	CODE	€
	LB1260005	21,00
	LB1260006	21,00
	LB1260007	21,00
	LB1260008	21,00

### Kit filtri colorati Ago

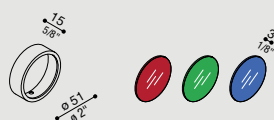

Kit composto dai seguenti filtri colorati: ROSSO, VERDE e BLU.

**Coloured filters Ago**  
Kit composed by the following coloured filters: RED, GREEN and BLUE.

**Kit filtres colores Ago**  
Kit composé des suivants: ROUGE, VERT et BLEU.

COL.	CODE	€
	LB1260001	21,00
	LB1260002	21,00
	LB1260003	21,00
	LB1260004	21,00

### Cavo H05RN-F 3x1



Cavo H05RN-F in Neoprene, sezione 3x1. Adatto ad uso esterno.

**Cable type H05RN-F 3x1**  
Cable type H05RN-F in Neoprene, section 3X1. Suitable for outdoor use.

**Câble H05RN-F 3x1**  
Câble H05RN-F en Néoprène, section 3X1. Egalement adapté à l'usage à l'extérieur.

5 m	10 m	15 m	20 m
CODE	CODE	CODE	CODE
LB1070054	LB1070055	LB1070056	LB1070057
€ 17,50	€ 31,00	€ 46,00	€ 59,50

### Braccetto Ago

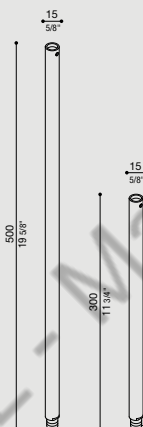

Possibilità di installazione Ago su braccetto altezza: 300 mm e 500 mm. Predisposto per installazione a terra. Palo in estruso di alluminio. Elevata resistenza all'ossidazione grazie al trattamento di passivazione.

**Bracket Ago**  
For Ago installation on bracket, height: 300 mm and 500 mm. Designed for ground installation. Post made of extruded aluminum. Highly resistant to oxidation due to the passivation treatment.

**Bras Ago**  
Possibilité d'installation Ago sur bras, hauteur: 500 mm - 300 mm. Prévu pour installation au sol. Poteau en aluminium extrudé. Excellente résistance à l'oxydation grâce au traitement de passivation.

Braccetto Ago H300 - Bracket Ago H300 - Bras Ago H300

COL.	CODE	€
	LB1260009	35,00
	LB1260010	35,00
	LB1260011	35,00
	LB1260012	35,00

Braccetto Ago H500 - Bracket Ago H500 - Bras Ago H500

COL.	CODE	€
	LB1260013	59,00
	LB1260014	59,00
	LB1260015	59,00
	LB1260016	59,00

### Adattatore albero

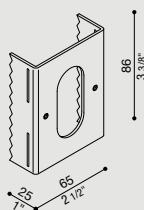

Adattatore per prodotti Ago, Tag e Noa in lamiera zincata per l'installazione su albero. Possibilità di installare più adattatori sullo stesso tronco. Abbinabile all'accessorio cinghia di fissaggio cod. LB1260019 (non inclusa).

**Adapter for tree installation**  
AGO/TAG/NOA adapter in galvanized plate for tree installation. Possibility to install several adapters on the same trunk. Combined with fixing strap accessory cod. LB1260019 (not included).

**Adapateur pour les arbres**  
Adapateur AGO/TAG/NOA en acier galvanisé pour l'installation sur les arbres. Possibilité d'installer plusieurs adaptateurs sur le même tronc. Peut être combiné avec la ceinture de fixation cod. LB1260019 (pas inclus).

COL.	CODE	€
	LB1260018	17,50

### Cinghia albero

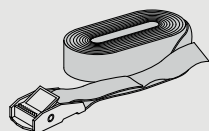

Cinghia albero lunghezza 6000 mm e larghezza 25 mm. Abbinabile all'adattatore albero cod. LB1260018 (non incluso).

**Tree belt**  
Tree belt 6000 mm length and 25 mm width. Combined with tree adapter cod. LB1260018 (not included).

**Ceinture pour arbre**, hauteur 6000 mm et largeur 25 mm. Peut être combinée avec l'adaptateur d'arbre cod. LB1260018 (pas inclus).

COL.	CODE	€
	LB1260019	31,00







**ACCESSORI**

Accessories / Accessoires

**Morsettiera coassiale**

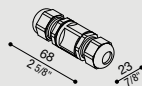

Morsettiera coassiale a 3 poli, IP68, per cavo  $\varnothing$  7/12 mm.

**Coaxial Terminal block**  
Coaxial 3-pole terminal block, IP68, for cable diameter 7/12 mm.

**Bornier coaxial**  
Bornier coaxial à 3 pôles, IP68, pour câble diam. 7/12 mm

COL.	CODE	€
	<b>LB11293</b>	<b>16,00</b>

**Morsettiera lineare a 3 vie**

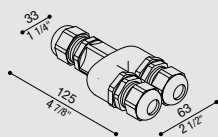

Morsettiera lineare a 3 vie a 3 poli, IP68, per cavo  $\varnothing$  7/13,5 mm.

**3 way linear terminal block**  
3-way 3-pole linear terminal block, IP68, for cable  $\varnothing$  7/13.5 mm.

**Bornier linéaire 3 voies**  
Bornier linéaire 3 voies à 3 pôles, IP68, pour câble diam. 7/13,5 mm

COL.	CODE	€
	<b>LB11294</b>	<b>25,50</b>

Ago Garden e Ago Garden Power.



# Ago



Ago Wall



Ago Garden Power + Adattatore albero



Ago Garden



Ago Garden Power



# Ago







# Ago Top



LED



outdoor

**ACCESSORI**

Accessories / Accessoires

Pag. 203



Adatto per uso esterno.

Corpo in alluminio anodizzato EN-6026; elevata resistenza all'ossidazione grazie al trattamento di anodizzazione. Diffusore in vetro temprato e serigrafato.

Apparecchio inaccessibile fornito con 0,30 m di cavo di alimentazione H05RN-F pre-cablato.

**LED 4000K (N), 3000K (3) o 2700K (2). Alimentatore escluso. Nessun rischio fotobiologico, RG0 gruppo di rischio esente (EN62471).**

**ENG** Suitable for outdoor installation.

Body made of EN-6026 anodized aluminum; highly resistant to oxidation due to anodizing treatment.

Heat tempered and silk-screen printed glass.

Inaccessible device, provided with 0,30 m prewired power cable H05RN-F.

**LED 4000K (N), 3000K (3), 2700K (2). Driver not included. No risk of photobiological damage, RG0 group (EN62471).**

**FRA** Adapté pour l'usage à l'extérieur.

Corp en aluminium EN-6026 anodisé, haute résistance à l'oxydation grâce au un traitement d'anodisation.

Diffuseur en verre trempé et sérigraphié.

Appareil câblé en usine, fourni avec 0,30 m de câble d'alimentation H05RN-F pré - câblé.

**LED 4000K (N), 3000K (3), 2700K (2) (blanche chaud). Alimentation exclus. Pas de risque photobiologique, RG0 groupe (EN62471).**

**Ago Top**

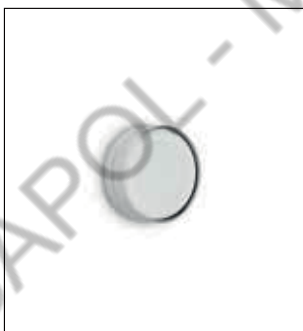

**Ago Top Asimmetrico**



**Outdoor e waterproof**



**Anodizzazione**

Anodisation  
Anodisation



**Pre-cablato**

Pre-wired  
Pré-câblé



**Anni di garanzia sul circuito LED**

Years warranty on LED circuit  
Ans de garantie sur la source LED

# Ago Top

## Ago Top



DIFF.  
TRASP.

IP66 IK07 2J xx5 CE UK  
CA

LED	W	LM	REAL LM	COL.	CODE *	€	* LED COLOUR
2	200	115			LL126008□	56,50	N 4000K
					LL126009□	56,50	3 3000K, lm -5%
					LL126010□	56,50	2 2700K, lm -5%
					LL126011□	56,50	

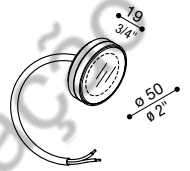

Idoneo per installazioni a parete e soffitto.

Suitable for wall and ceiling installation.

Adapté pour les installations murales et au plafond.

## Ago Top Asimmetrico



DIFF.  
TRASP.

IP66 IK07 2J xx5 CE UK  
CA

LED	W	LM	REAL LM	COL.	CODE *	€	* LED COLOUR
2	200	25			LL126012□	56,50	N 4000K
					LL126013□	56,50	3 3000K, lm -5%
					LL126014□	56,50	2 2700K, lm -5%
					LL126015□	56,50	

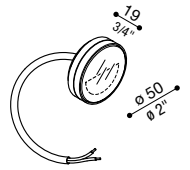

Idoneo per installazioni a parete.  
Versione asimmetrica.

Suitable for wall installation.  
Asymmetric version.

Adapté pour l'installation murale.  
Version asymétrique.



Ago Top Asimmetrico



Ago Top



**ACCESSORI**  
Accessories / Accessoires

**Alimentatore AGO TOP/TOP ASIMMETRICO in tensione costante 24V**

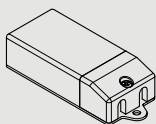

AGO TOP/TOP ASIMMETRICO ballasts in constant tension 24V available

Alimentations AGO TOP/ TOP ASIMMETRICO en tension 24V disponibles

N. MAX	IP	CODE	€
1/6	20	LB1070029	40,50
1/11	20	LB1070030	50,00
1/6	67	LB1070031	37,50
1/13	67	LB1070032	52,50

**Cavo H05RN-F 2x0,75**



Cavo H05RN-F in Neoprene, sezione 2x0,75. Adatto ad uso esterno.

Cable type H05RN-F 2x0,75  
Cable type H05RN-F in Neoprene, section 2x0,75. Suitable for outdoor use.

Câble H05RN-F 2x0,75  
Câble H05RN-F en Néoprène, section 2x0,75. Egalement adapté à l'usage à l'extérieur.

5 m		15 m	
CODE	€	CODE	€
LB1070004	11,00	LB1070006	33,00
10 m		20 m	
CODE	€	CODE	€
LB1070005	22,00	LB1070007	42,00

**Morsettiera coassiale**

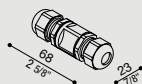

Morsettiera coassiale a 3 poli, IP68, per cavo ø 7/12 mm.

Coaxial Terminal block  
Coaxial 3-pole terminal block, IP68, for cable diameter 7/12 mm.

Bornier coaxial  
Bornier coaxial à 3 pôles, IP68, pour câble diam. 7/12 mm

COL.	CODE	€
	LB11293	16,00

**Morsettiera lineare a 3 vie**

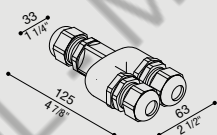

Morsettiera lineare a 3 vie a 3 poli, IP68, per cavo ø 7/13,5 mm.

3 way linear terminal block  
3-way 3-pole linear terminal block, IP68, for cable Ø 7/13,5 mm.

Bornier linéaire 3 voies  
Bornier linéaire 3 voies à 3 pôles, IP68, pour câble diam. 7/13,5 mm

COL.	CODE	€
	LB11294	25,50

**Scaricatori SPD**  
Surge protector devices



Pag. 448

**Finishing**

	Alluminio Anodizzato Grigio Grey Anodized Aluminium Aluminium anodisé Gris		Alluminio Anodizzato Verde Green Anodized Aluminium Aluminium anodisé Vert
	Alluminio Anodizzato Nero Black Anodized Aluminium Aluminium anodisé Noir		Alluminio Anodizzato Marrone Brown Anodized Aluminium Aluminium anodisé Marron

**\* Led colour**

- N** 4000K
- 3** 3000K, Im -5%
- 2** 2700K, Im -5%

**Completa il codice**  
sostituendo al quadrato rosso la lettera o il numero corrispondente alla temperatura colore scelta.

**Complete the code**  
by replacing the red box with the letter or number corresponding to the selected colour temperature.

**Compléter le code**  
en remplaçant le carré rouge par la lettre ou le numéro correspondant à la sélection de température couleur.

**⊗ Alimentatore escluso**  
Driver not included  
Alimentation non incluse

# Ago Applique

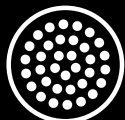

LED



outdoor

**ACCESSORI**

Accessories / Accessoires

Pag. 207





Adatto per installazione a muro per uso esterno. Corpo in alluminio anodizzato EN-6026, elevata resistenza all'ossidazione grazie al trattamento di anodizzazione. Diffusore in vetro temprato e serigrafato. Base in policarbonato e staffa di fissaggio a muro in tecnopolimero. Compreso di connettori gel rapidi IP68 per il cablaggio. Bulloneria in acciaio inox A4. LED a tensione di rete dimmerabile a taglio di fase.

**LED 4000K (N), 3000K (3), o 2700K (2). LED a tensione di rete. Nessun rischio fotobiologico, RGO gruppo di rischio esente (EN62471).**

**ENG** Suitable for wall installation, also for outdoor use. Body made of EN-6026 anodized aluminum, highly resistant to oxidation thanks to anodizing treatment. Heat tempered and silk-screen printed glass. Polycarbonate base and technopolymer wall fixing bracket. Including IP68 quick gel connectors for wiring. A4 stainless steel nuts and bolts. LED AC Direct, phase cut dimmable. LED 4000K (N), 3000K (3) or 2700K (2). LED AC Direct. No risk of photobiological damage, RGO group (EN62471).

**FRA** Convient pour une installation murale, également pour une utilisation à l'extérieur. Corps en aluminium anodisé EN-6026, haute résistance à l'oxydation grâce au traitement d'anodisation. Diffuseur en verre trempé et sérigraphié. Base en polycarbonate et support de fixation murale en technopolymère. Compris des connecteurs rapides gel IP68 pour le câblage. Visserie en acier inox type A4. LED Direct dimmable coupure de phase. LED 4000K (N), 3000K (3) ou 2700K (2) (blanche chaud). LED Direct 220-240. Pas de risque photobiologique, RGO groupe (EN62471).

**Ago Applique**



**Ago Applique U&D**



**Outdoor  
e waterproof**



**Anodizzazione**  
Anodisation  
Anodisation







**Dimmerabile**  
Dimmable  
Dimmable



**Anni di garanzia  
sul circuito LED**  
Years warranty on LED circuit  
Ans de garantie sur la source LED

**Finishing**

	Alluminio Anodizzato Grigio Grey Anodized Aluminium Aluminium anodisé Gris		Alluminio Anodizzato Marrone Brown Anodized Aluminium Aluminium anodisé Marron
	Alluminio Anodizzato Nero Black Anodized Aluminium Aluminium anodisé Noir		Bianco RAL 9010 White RAL 9010 Blanc RAL 9010

# Ago Applique

## Ago Applique



DIFF.  
TRASP.

IP66 IK 07 2J xx5 CE UK  
CA

LED	W	LM	REAL LM	COL.	CODE **	€	* OPTIC	* LED COLOUR
5	600	497	AC DIRECT	Grey	LL126200□□	124,00	D Diff.	N 4000K
				Black	LL126201□□	124,00	S 25°	3 3000K, Im -5%
				White	LL126202□□	124,00	M 40°	2 2700K, Im -5%
				Black	LL126203□□	124,00	L 65°	

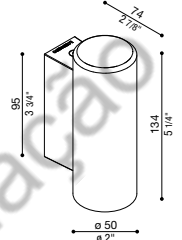

Versione monoemissione.  
Versione LL126203: Alluminio verniciato

Unidirectional version.  
Version LL126203: Painted aluminium

Version unidirectionnelle.  
Version LL126203: aluminium peint

## Ago Applique U&D



DIFF.  
TRASP.

IP66 IK 07 2J xx5 CE UK  
CA

LED	W	LM	REAL LM	COL.	CODE **	€	* OPTIC	* LED COLOUR
10	1200	996	AC DIRECT	Grey	LL126204□□	155,00	D Diff.	N 4000K
				Black	LL126205□□	155,00	S 25°	3 3000K, Im -5%
				White	LL126206□□	155,00	M 40°	2 2700K, Im -5%
				Black	LL126207□□	155,00	L 65°	

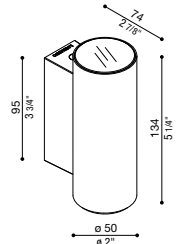

Versione biemissione.  
Versione LL126207: Alluminio verniciato

Bidirectional version.  
Version LL126207: Painted aluminium

Version bidirectionnelle.  
Version LL126207: aluminium peint



Colori disponibili.  
Available colours.  
Couleurs disponibles.



\* Disponibile a richiesta base colorata.  
Coloured base available on request.  
Base de couleur disponible sur requête.



**ACCESSORI**

Accessories / Accessoires

**Base Ago Applique verniciata**

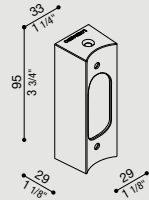

Base Ago Applique verniciata

*Painted Ago Applique base*

*Base Ago Applique peint*

COL.	CODE	€
	LB1262004	11,50
	LB1262005	11,50



Ago Applique



Ago Applique

# Ago Bollard

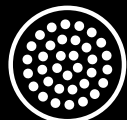

LED



outdoor

**ACCESSORI**

Accessories / Accessoires

Pag. 213



Adatto per installazione a terra. Corpo in alluminio anodizzato EN-6026, elevata resistenza all'ossidazione grazie al trattamento di anodizzazione. Diffusore in policarbonato stabilizzato ai raggi UV. Completo di due staffe di fissaggio in alluminio. Tirafondi e minuterie per ancoraggio del palo al terreno inclusi. Compreso di connettori gel rapidi IP68 per il cablaggio. Bulloneria in acciaio inox A4.

Disponibile versione LED a tensione di rete, dimmerabile a taglio di fase.

Disponibile versione 24V.

**LED 4000K (N), 3000K (3), o 2700K (2). Nessun rischio fotobiologico, RGO gruppo di rischio esente (EN62471).**

**ENG** Suitable for ground installation. Body made of EN-6026 anodized aluminum, highly resistant to oxidation thanks to anodizing treatment. UV-stabilized polycarbonate diffuser. Complete with two aluminum fixing brackets. Anchor bolts and screws for ground anchoring included. Including IP68 quick gel connectors for wiring. A4 stainless steel nuts and bolts.

Available LED AC direct, phase cut dimmable.

Available 24V version.

**LED 4000K (N), 3000K (3) or 2700K (2). No risk of photobiological damage, RGO group (EN62471).**

**FRA** Adapté pour une installation au sol. Corps en aluminium anodisé EN-6026, haute résistance à l'oxydation grâce au traitement d'anodisation. Diffuseur en polycarbonate stabilisé aux UV. Complet avec deux supports de fixation en aluminium. Tire-fond et visserie pour d'ancrage du poteau au sol inclus. Compris des connecteurs rapides gel IP68 pour le câblage. Visserie en acier inox type A4.

Disponible en LED AC direct 220-240V, dimmable coupure de phase.

Disponible en version 24V.

**LED 4000K (N), 3000K (3) ou 2700K (2) (blanche chaud). Pas de risque photobiologique, RGO groupe (EN62471).**

**Ago Bollard H300 1L**

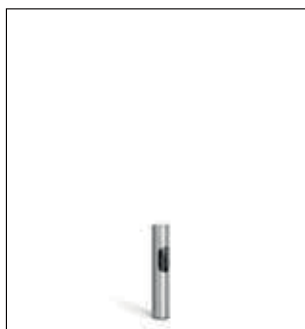

**Ago Bollard H300 2L**



**Outdoor  
e waterproof**



**Ago Bollard H600 1L**



**Ago Bollard H600 2L**



**Anodizzazione**

Anodisation  
Anodisation



**Dimmerabile**

Dimmable  
Dimmable

**Ago Bollard H900 1L**



**Ago Bollard H900 2L**



**Anni di garanzia  
sul circuito LED**

Years warranty on LED circuit  
Ans de garantie sur la source LED



# Ago Bollard

## Ago Bollard H300 1L



DIFF.  
TRASP.

IP66 IK 07 2J xx5 CE UK CA

LED	W	LM	REAL LM	COL.	CODE *	€	* LED COLOUR
10	1100	270	AC DIRECT		LL126318□	244,50	N 4000K
					LL126319□	244,50	S 3000K, lm -5%
					LL126320□	244,50	2 2700K, lm -5%
10	1100	270	24V		LT126318□	255,00	
					LT126319□	255,00	
					LT126320□	255,00	

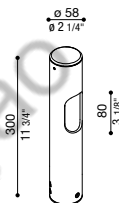

Versione monoemissione.

Unidirectional version.

Version unidirectionnelle.

## Ago Bollard H300 2L



DIFF.  
TRASP.

IP66 IK 07 2J xx5 CE UK CA

LED	W	LM	REAL LM	COL.	CODE *	€	* LED COLOUR
10	1100	540	AC DIRECT		LL126321□	244,50	N 4000K
					LL126322□	244,50	S 3000K, lm -5%
					LL126323□	244,50	2 2700K, lm -5%
10	1100	540	24V		LT126321□	255,00	
					LT126322□	255,00	
					LT126323□	255,00	

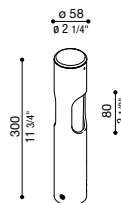

Versione biemissione.

Bidirectional version.

Version bidirectionnelle.

## Ago Bollard H600 1L



DIFF.  
TRASP.

IP66 IK 07 2J xx5 CE UK CA

LED	W	LM	REAL LM	COL.	CODE *	€	* LED COLOUR
10	1100	270	AC DIRECT		LL126300□	270,50	N 4000K
					LL126301□	270,50	S 3000K, lm -5%
					LL126302□	270,50	2 2700K, lm -5%
10	1100	270	24V		LT126300□	281,00	
					LT126301□	281,00	
					LT126302□	281,00	

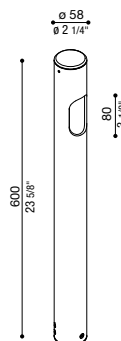

Versione monoemissione.

Unidirectional version.

Version unidirectionnelle.

### Finishing

Alluminio Anodizzato Grigio  
Grey Anodized Aluminium  
Aluminium anodisé Gris

Alluminio Anodizzato Marrone  
Brown Anodized Aluminium  
Aluminium anodisé Marron

Alluminio Anodizzato Nero  
Black Anodized Aluminium  
Aluminium anodisé Noir

### \* Led colour

- N 4000K
- S 3000K, lm -5%
- 2 2700K, lm -5%

**Completa il codice**  
sostituendo al quadrato rosso la lettera o il numero corrispondente alla temperatura colore scelta.

**Complete the code**  
by replacing the red box with the letter or number corresponding to the selected colour temperature.

**Compléter le code**  
en remplaçant le carré rouge par la lettre ou le numéro correspondant à la sélection de température couleur.

### ✓ Alimentatore integrato

Integrated driver  
Alimentation intégrée

### ✗ Alimentatore escluso

Driver not included /  
Alimentation non incluse



**Ago Bollard  
H600 2L**



DIFF.  
TRASP.

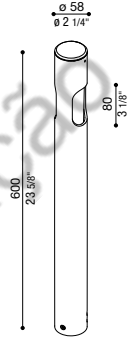

IP 66 IK 07 2J xx5 CE UK  
CA

LED	W	LM	REAL LM	COL.	CODE *	€	* LED COLOUR
	10	1100	540	⊕ AC DIRECT	LL126303	270,50	N 4000K
					LL126304	270,50	3 3000K, lm -5%
					LL126305	270,50	2 2700K, lm -5%
	10	1100	540	⊖ 24V	LT126303	281,00	
					LT126304	281,00	
					LT126305	281,00	

Versione biemissione.

Bidirectional version.

Version bidirectionnelle.

**Ago Bollard  
H900 1L**



DIFF.  
TRASP.

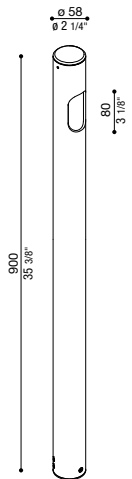

IP 66 IK 07 2J xx5 CE UK  
CA

LED	W	LM	REAL LM	COL.	CODE *	€	* LED COLOUR
	10	1100	270	⊕ AC DIRECT	LL126309	296,50	N 4000K
					LL126310	296,50	3 3000K, lm -5%
					LL126311	296,50	2 2700K, lm -5%
	10	1100	270	⊖ 24V	LT126309	307,00	
					LT126310	307,00	
					LT126311	307,00	

Versione monoemissione.

Unidirectional version.

Version unidirectionnelle.

**Ago Bollard  
H900 2L**



DIFF.  
TRASP.

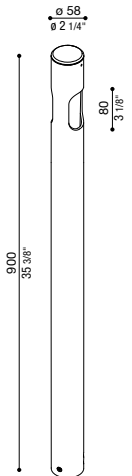

IP 66 IK 07 2J xx5 CE UK  
CA

LED	W	LM	REAL LM	COL.	CODE *	€	* LED COLOUR
	10	1100	540	⊕ AC DIRECT	LL126312	296,50	N 4000K
					LL126313	296,50	3 3000K, lm -5%
					LL126314	296,50	2 2700K, lm -5%
	10	1100	540	⊖ 24V	LT126312	307,00	
					LT126313	307,00	
					LT126314	307,00	

Versione biemissione.

Bidirectional version.

Version bidirectionnelle.

# Ago Bollard



Base tonda.  
Round base.  
Base ronde.



Base quadrata.  
Square base.  
Base carrée.



Colori disponibili.  
Available colours.  
Couleurs disponibles.





**ACCESSORI**  
Accessories / Accessoires

**Morsettiera coassiale**

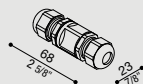

Morsettiera coassiale a 3 poli, IP68, per cavo  $\varnothing$  7/12 mm.

**Coaxial Terminal block**  
Coaxial 3-pole terminal block,  
IP68, for cable diameter 7/12 mm.

**Bornier coaxial**  
Bornier coaxial à 3 pôles, IP68,  
pour câble diam. 7/12 mm

COL.	CODE	€
	<b>LB11293</b>	<b>16,00</b>

**Morsettiera lineare a 3 vie**

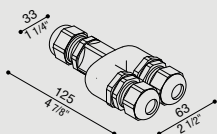

Morsettiera lineare a 3 vie a 3 poli, IP68, per cavo  $\varnothing$  7/13,5 mm.

**3 way linear terminal block**  
3-way 3-pole linear terminal block,  
IP68, for cable  $\varnothing$  7/13,5 mm.

**Bornier linéaire 3 voies**  
Bornier linéaire 3 voies à 3 pôles,  
IP68, pour câble diam. 7/13,5 mm

COL.	CODE	€
	<b>LB11294</b>	<b>25,50</b>



Ago Bollard H600 2L



# Ago Bollard

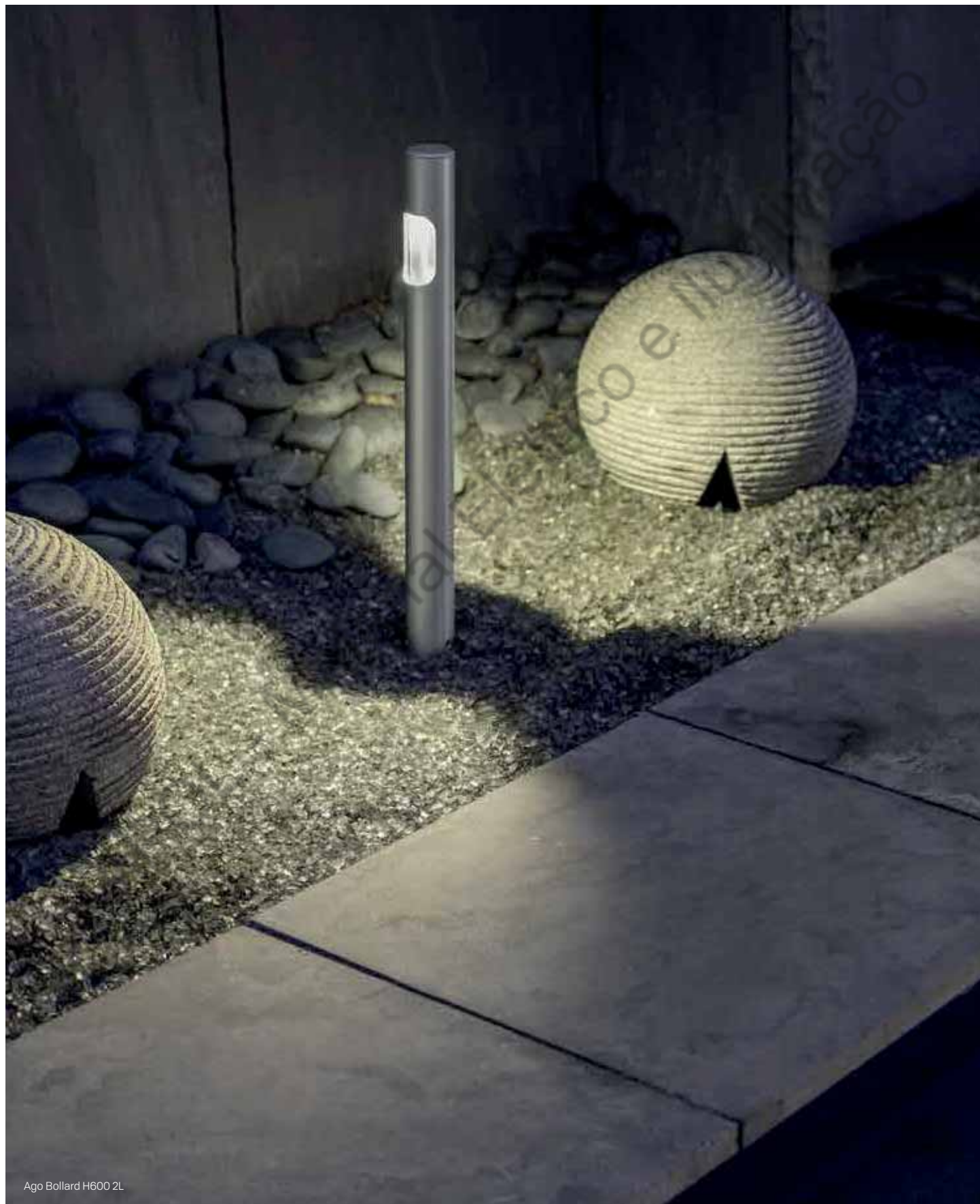































Ago Bollard H900 1L

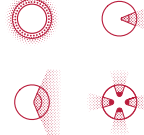
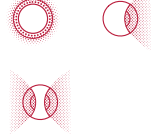











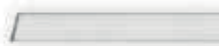







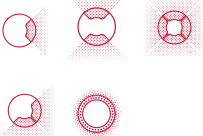
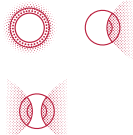

Ago Bollard H300 1L

# INC-CNC RNC-TNC

					
	<b>INC 35</b>	<b>INC 50</b>	<b>CNC 25</b>	<b>CNC 35</b>	<b>CNC 50</b>
	pag. 220	pag. 220	pag. 228	pag. 229	pag. 232
<b>Caratteristiche</b> Characteristics Caractéristiques	 <b>65°<sup>MAX</sup></b>  <b>500 KG<sup>MAX</sup></b>	 <b>65°<sup>MAX</sup></b>  <b>500 KG<sup>MAX</sup></b>	 <b>65°<sup>MAX</sup></b>  <b>500 KG<sup>MAX</sup></b>	 <b>65°<sup>MAX</sup></b>  <b>500 KG<sup>MAX</sup></b>  <b>1000 KG<sup>MAX</sup></b>	 <b>65°<sup>MAX</sup></b>  <b>450 KG<sup>MAX</sup></b>  <b>500 KG<sup>MAX</sup></b>  <b>2000 KG<sup>MAX</sup></b>
<b>Emissione</b> Emission Émission					
<b>Colore della luce</b> LED colour Couleur du LED	<b>N</b> 4000K <b>S</b> 3000K, lm -5% <b>Z</b> 2700K, lm -5%	<b>N</b> 4000K <b>S</b> 3000K, lm -5% <b>Z</b> 2700K, lm -5%	<b>N</b> 4000K <b>S</b> 3000K, lm -5% <b>Z</b> 2700K, lm -5% <b>B</b> Blue	<b>N</b> 4000K <b>S</b> 3000K, lm -5% <b>Z</b> 2700K, lm -5% <b>B</b> Blue	<b>N</b> 4000K <b>S</b> 3000K, lm -5% <b>Z</b> 2700K, lm -5%
<b>Inclinazione ottiche</b> Optics Optique	<b>S</b> 14° <b>M</b> 29° <b>L</b> 46°	<b>S</b> 13° <b>M</b> 24° <b>L</b> 53°	<b>M</b> 30° <b>S</b> 15° <b>D</b> Diff.	<b>S</b> 14° <b>M</b> 29° <b>L</b> 46° <b>D</b> Diff.	<b>S</b> 13° <b>M</b> 24° <b>L</b> 46° <b>D</b> Diff.
<b>Potenza</b> Output Puissance	2 W 180 LM	6,5 W 650 LM	2 W 180 LM	2 W 180 LM	6,5 W 650 LM
<b>Alimentazione</b> Power supply Alimentation	500 mA - 4.8 V 12/24 V	500 mA - 14 V 24 V	500 mA - 4.8 V 12/24 V	500 mA - 4.8 V 12/24 V	500 mA - 14 V 24 V
<b>Forma</b> Shape Forme					



						
	<b>CNC 99</b>	<b>CNC 100</b>	<b>CNC 120</b>	<b>CNC 150</b>	<b>RNC</b>	<b>TNC</b>
	pag. 240	pag. 248	pag. 254	pag. 260	pag. 266	pag. 274
	 45/55° MAX  500 KG MAX  2000 KG MAX	 50° MAX  280 KG MAX  2000 KG MAX	 60° MAX  2000 KG MAX	 58° MAX  2000 KG MAX	 35° MAX  2000 KG MAX	
						
	<ul style="list-style-type: none"> <li><span style="border: 1px solid black; padding: 1px;">N</span> 4000K</li> <li><span style="border: 1px solid black; padding: 1px;">3</span> 3000K, Im -5%</li> <li><span style="border: 1px solid black; padding: 1px;">2</span> 2700K, Im -5%</li> </ul>	<ul style="list-style-type: none"> <li><span style="border: 1px solid black; padding: 1px;">N</span> 4000K</li> <li><span style="border: 1px solid black; padding: 1px;">3</span> 3000K, Im -5%</li> <li><span style="border: 1px solid black; padding: 1px;">2</span> 2700K, Im -5%</li> </ul>	<ul style="list-style-type: none"> <li><span style="border: 1px solid black; padding: 1px;">N</span> 4000K</li> <li><span style="border: 1px solid black; padding: 1px;">3</span> 3000K, Im -5%</li> <li><span style="border: 1px solid black; padding: 1px;">2</span> 2700K, Im -5%</li> </ul>	<ul style="list-style-type: none"> <li><span style="border: 1px solid black; padding: 1px;">N</span> 4000K</li> <li><span style="border: 1px solid black; padding: 1px;">3</span> 3000K, Im -5%</li> <li><span style="border: 1px solid black; padding: 1px;">2</span> 2700K, Im -5%</li> </ul>	<ul style="list-style-type: none"> <li><span style="border: 1px solid black; padding: 1px;">N</span> 4000K</li> <li><span style="border: 1px solid black; padding: 1px;">3</span> 3000K, Im -5%</li> <li><span style="border: 1px solid black; padding: 1px;">2</span> 2700K, Im -5%</li> </ul>	
	-	-	<ul style="list-style-type: none"> <li><span style="border: 1px solid black; padding: 1px;">S</span> Spot-25°</li> <li><span style="border: 1px solid black; padding: 1px;">M</span> 60°</li> <li><span style="border: 1px solid black; padding: 1px;">A</span> Asymm.</li> <li><span style="border: 1px solid black; padding: 1px;">D</span> Diff.</li> <li><span style="border: 1px solid black; padding: 1px;">B</span> Blade</li> </ul>	<ul style="list-style-type: none"> <li><span style="border: 1px solid black; padding: 1px;">S</span> 12°</li> <li><span style="border: 1px solid black; padding: 1px;">M</span> 24°</li> <li><span style="border: 1px solid black; padding: 1px;">L</span> 32°</li> </ul>	-	-
	5 W 450 LM	3 - 5 W 215 - 430 LM	9 W 1000 LM	20W 2800 LM	2,5 - 20 W 300 - 2400 LM	5 - 20 W 550 - 2200 LM
	24 V	700 mA - 3.10 V 220 - 240 V	700 mA - 12V 12/24 V	600 mA	24V	24V
						

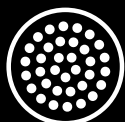

LED

Material Eléctrico e Iluminação



indoor



outdoor





Adatto per installazioni a parete e soffitto, anche per uso esterno. Idoneo per incassi da terra ad uso calpestabile, fissaggio mediante armatura da incasso fornita a parte. Prodotto finalizzato all'impiego di sorgenti luminose a LED per luce di accento e segnalazione. Ghiera in acciaio AISI316L. Corpo in alluminio anodizzato nero. Diffusore in vetro temprato. Guarnizioni in silicone. 1.5 m di cavo di alimentazione HO5RN-F pre-cablato e bloccato tramite pressacavo in Ottone Nichelato.

Dimmerazione disponibile. Bulloneria in acciaio inox AISI 316L. Tutti i cavi sono provvisti di una speciale guaina che protegge il faretto dalle infiltrazioni di acqua e umidità.

La molla di ritenuta si adatta sia per applicazioni che prevedono l'utilizzo di armatura da incasso che direttamente in controsoffittature in cartongesso. Versione in tensione costante 12/24V. Versione in corrente costante 350 mA/500 mA: utilizzare esclusivamente alimentatori di tipo SELV o equivalenti.

Tutti i cavi vengono forniti integrati di un sistema elettronico che consente il collegamento non polarizzato del faretto. INC 35 : Il dispositivo elettronico inoltre, impedisce l'interruzione di linee di faretti collegati in serie nel caso di guasto di un singolo prodotto.

**LED 4000K (N), 3000K (3), o 2700K (2). Alimentatore escluso. Nessun rischio fotobiologico, RGO gruppo di rischio esente (EN62471).**

**ENG** Suitable for installation on walls and ceilings and for outdoor use. Ideal for recessed ground application, also for walk-over use. Installation by means of a recess box supplied separately. Product designed for LED light sources for accent lighting and marking driveways and pathways. Retaining ring made of stainless steel AISI 316L.

Body made of black anodized aluminum. Heat tempered glass diffuser. Silicone gaskets. 1.5 m. pre-wired cable type HO5RN-F, secured by means of a nickel-plated brass cable gland. Dimmable version available. A4 or AISI 316L stainless steel nuts and bolts. All the wiring is supplied with a special sheathing protecting the spot from seepage of water and damp. The retaining spring adapts both to applications requiring the use of the recess box or for fittings directly on plasterboard ceilings. Version in constant tension 12/24V. Version in constant current 350mA/500mA: only drivers type SELV or equivalent must be used. All the wiring is supplied with a built-in electronic system that allows a non-polarised connection of the spot light.

INC 35: moreover, the electronic device prevents the interruption of whole rows of downlights connected together in the event of a fault on just one of the products.

**LED 4000K (N), 3000K (3) or 2700K (2). Ballast not included. No risk of photobiological damage, RGO group (EN62471).**

**FRA** Également adapté pour les installations murales et les plafonds et à l'usage à l'extérieur. Convient aussi pour une utilisation au sol piétonnable, fixation par une boîte d'encastrement fournie à part. Produit finalisé à l'emploi de sources lumineuses à LED pour éclairage d'accentuation et de signalisation. Colletterie en acier inox type AISI 316L.

Corps en aluminium anodisé noir. Diffuseur en verre trempé. Joints en silicone. Câble d'alimentation HO5RN-F de 1.5m et bloqué par un presse-câble en laiton nickelé. Version dimmable disponible. Vis de fixation en acier inox type A4 ou AISI 316L. Tous les câbles sont fournis avec une gaine spéciale qui protège le spot des infiltrations d'eau et d'humidité. Le ressort de retenue s'adapte aussi bien pour des applications qui prévoient l'utilisation de boîte d'encastrement que pour des applications directement sur les faux-plafonds en placoplâtre. Version en tension 12/24V. Version en courant constant 350mA/500mA: utilisez exclusivement les drivers du type SELV ou équivalent. Tous les câbles sont fournis avec intégration d'un système électronique qui permet le branchement non polarisé du spot.

INC 35: en outre, le système électronique empêche l'interruption des lignes de spots connectés en série en cas de défaillance d'un seul produit.

**LED 4000K (N), 3000K (3) ou 2700K (2). Alimentation exclus. Pas de risque photobiologique, RGO groupe (EN62471).**



**Outdoor  
e waterproof**



**Aquastop**

**INC 35**



**INC 50**



**Pre-cablato**  
Pre-wired  
Pré-câblé



**Anni di garanzia  
sul circuito LED**  
Years warranty on LED circuit  
Ans de garantie sur la source LED



# INC

## INC 35



DIFF.  
VETRO

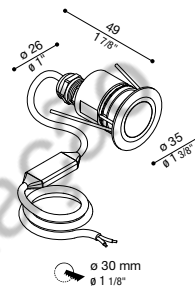

IP 67 IK 10 20J xx9 CE UK CA 500<sup>KG</sup> MAX 65<sup>°C</sup> MAX

LED	W	LM	REAL LM	COL.	CODE **	€	* OPTIC	* LED COLOUR
2	180	120	500mA - 4,8V	LL132000□□	93,50	S 14°	N 4000K	
				LL132001□□	99,00	M 29°	3 3000K, Im -5%	
				LL132002□□	99,00	L 46°	2 2700K, Im -5%	
2	180	120	12/24V	LL132003□□	111,50			
				LL132004□□	116,00			
				LL132005□□	116,00			

Versione ghiera tonda, possibile scelta di 3 differenti ottiche.  
Temperatura massima rilevata sul vetro 65°C.

Version with round retaining ring, choice of 3 different optics.  
Max. temperature measured on the glass 65°C.

Version avec virole ronde, choix possible de 3 optiques différentes. Température relevée sur le verre 65°C maxi.

## INC 50



DIFF.  
VETRO

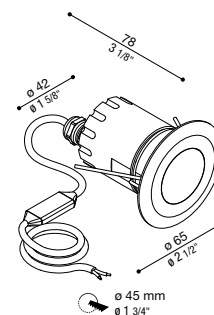

IP 67 IK 10 20J xx9 CE UK CA 500<sup>KG</sup> MAX 65<sup>°C</sup> MAX

LED	W	LM	REAL LM	COL.	CODE **	€	* OPTIC	* LED COLOUR
6,5	650	418	500mA - 14V	LL132006□□	128,50	S 13°	N 4000K	
				LL132007□□	133,50	M 24°	3 3000K, Im -5%	
				LL132008□□	133,50	L 53°	2 2700K, Im -5%	
6,5	650	418	24V	LL132009□□	146,00			
				LL132010□□	150,50			
				LL132011□□	150,50			

Versione ghiera tonda, possibile scelta di 3 differenti ottiche.  
Temperatura massima rilevata sul vetro 65°C.

Version with round retaining ring, choice of 3 different optics.  
Max. temperature measured on the glass 65°C.

Version avec virole ronde, choix possible de 3 optiques différentes. Température relevée sur le verre 65°C maxi.



### Finishing

Inox satinato  
Satin grey  
Inox satiné

Grigio antracite RAL 7021  
Grey anthracite RAL 7021  
Gris anthracite RAL 7021

Bianco RAL 9010  
White RAL 9010  
Blanc RAL 9010

### \* Led colour

- N 4000K
- 3 3000K, Im -5%
- 2 2700K, Im -5%

**Completa il codice**  
sostituendo al quadrato rosso la lettera o il numero corrispondente alla temperatura colore scelta.

**Complete the code**  
by replacing the red box with the letter or number corresponding to the selected colour temperature.

**Compléter le code**  
en remplaçant le carré rouge par la lettre ou le numéro correspondant à la sélection de température couleur.

**⊗ Alimentatore escluso**  
Driver not included  
Alimentation non incluse



**ACCESSORI**

Accessories / Accessoires

**Armatura da incasso INC 35**

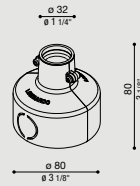

Armatura da incasso in termoplastico.

*Thermoplastic recess box INC 35*  
Thermoplastic recess box.

*Armature à encastrer INC 35*  
Armature à encastrer en matériau thermoplastique.

COL.	CODE	€
	<b>LB1070001</b>	<b>5,80</b>

**Armatura da incasso INC 50**

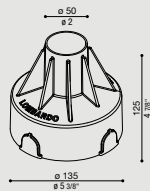

Armatura da incasso in termoplastico.

*Recess box INC 50*  
Thermoplastic recess box.

*Boîte d'encastrement INC 50*  
Armature à encastrer en matériau thermoplastique.

COL.	CODE	€
	<b>LB1070039</b>	<b>5,80</b>

**Alimentatori INC 35 in corrente costante**

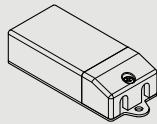

*INC 35 ballasts in constant current*

*Alimentations INC 35 en courant constant*

**350mA**

**500mA**

N° max fixtures	IP	CODE	€	N° max fixtures	IP	CODE	€
1/2	20	<b>LB1070008</b>	<b>28,00</b>	1/2	20	<b>LB1070015</b>	<b>33,00</b>
1/3	20	<b>LB1070009</b>	<b>33,00</b>	1/3	20	<b>LB1070016</b>	<b>40,50</b>
5/10	20	<b>LB1070011</b>	<b>46,00</b>	5/10	20	<b>LB1070018</b>	<b>47,00</b>
1/12 1-10 PUSH	20	<b>LB1070012</b>	<b>69,00</b>	1/12 1-10 PUSH	20	<b>LB1070019</b>	<b>67,50</b>
2/4	67	<b>LB1070013</b>	<b>30,00</b>	1/4	67	<b>LB1070020</b>	<b>44,50</b>
5/10	67	<b>LB1070014</b>	<b>44,50</b>	5/10	67	<b>LB1070021</b>	<b>76,00</b>
3/9 DALI	20	<b>LB1070064</b>	<b>88,00</b>	3/9 DALI	20	<b>LB1070064</b>	<b>88,00</b>

**Alimentatori INC 50 in corrente costante**

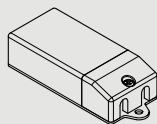

*INC 50 ballasts in constant current*

*Alimentations INC 50 en courant constant*

**350mA**

**500mA**

N° max fixtures	IP	CODE	€	N° max fixtures	IP	CODE	€
1	20	<b>LB1070009</b>	<b>33,00</b>	1	20	<b>LB1070016</b>	<b>40,50</b>
1/3	20	<b>LB1070011</b>	<b>46,00</b>	1/3	20	<b>LB1070018</b>	<b>47,00</b>
1/3 1-10 PUSH	20	<b>LB1070012</b>	<b>69,00</b>	1/4 1-10 PUSH	20	<b>LB1070019</b>	<b>67,50</b>
1/2	67	<b>LB1070013</b>	<b>30,00</b>	1/2	67	<b>LB1070020</b>	<b>44,50</b>
1/3	67	<b>LB1070014</b>	<b>44,50</b>	1/4	67	<b>LB1070021</b>	<b>76,00</b>
1/3 DALI	20	<b>LB1070064</b>	<b>88,00</b>	1/3 DALI	20	<b>LB1070064</b>	<b>88,00</b>

**Alimentatore INC in tensione costante 12/24V**

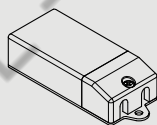

*INC ballasts in constant tension 12/24V*

*Alimentations INC en tension 12/24V*

**12V**

**24V**

N° max	IP	CODE	€	N° max	IP	CODE	€	
<b>INC 35</b>				<b>INC 35 INC 50</b>				
1/6	20	<b>LB1070025</b>	<b>34,00</b>	1/6	1/2	20	<b>LB1070029</b>	<b>40,50</b>
1/12	20	<b>LB1070026</b>	<b>50,00</b>	1/12	1/4	20	<b>LB1070030</b>	<b>50,00</b>
1/8	67	<b>LB1070027</b>	<b>37,50</b>	1/8	1/2	67	<b>LB1070031</b>	<b>37,50</b>
1/15	67	<b>LB1070028</b>	<b>52,50</b>	1/15	1/7	67	<b>LB1070032</b>	<b>52,50</b>

**Cavo H05RN-F 2x0,75**



Cavo H05RN-F in Neoprene, sezione 2x0,75. Adatto ad uso esterno.

*Cable type H05RN-F 2x0,75*  
Cable type H05RN-F in Neoprene, section 2x0,75. Suitable for outdoor use.

*Câble H05RN-F 2x0,75*  
Câble H05RN-F en Néoprène, section 2x0,75. Egalement adapté à l'usage à l'extérieur.

5 m	15 m		
CODE	€	CODE	€
<b>LB1070004</b>	<b>11,00</b>	<b>LB1070006</b>	<b>33,00</b>
10 m	20 m		
CODE	€	CODE	€
<b>LB1070005</b>	<b>22,00</b>	<b>LB1070007</b>	<b>42,00</b>



# INC







INC 50



INC 35

# CNC

**25**

CNC 25 T



CNC 25 Q



**35**

CNC 35 T



CNC 35 T Up



CNC 35 Q

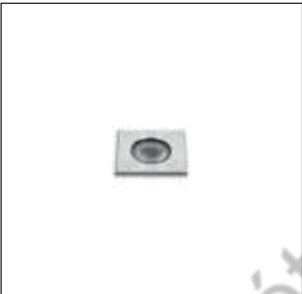

CNC 35 Q Up



CNC 35 Top S



CNC 35 Top L



CNC 35 Mask



CNC 35 Swing



CNC 35 Swing Spot



**50**

CNC 50 T



CNC 50 T Up



CNC 50 Top L



CNC 50 TOP 2L



CNC 50 Swing



CNC 50 Swing Spot







**99**

**CNC 99 CL**



**CNC 99 C2L**



**CNC 99 C4L**



Finto incasso.  
Surface mounted.  
Faux encastré.

**CNC 99 C180**



**CNC 99 C UP**



**100**

**CNC 100 L**



**CNC 100 2L**



**CNC 100 UP**



Incasso.  
Recessed.  
À encastrer.

**CNC 100 CL**



**CNC 100 C2L**



**CNC 100 C-UP**



Finto incasso.  
Surface mounted.  
Faux encastré.

**120**

**CNC 120 T**



**150**

**CNC 150**



# CNC

## 25-35-50



LED

APOL - Material Eléctrico e Iluminação



indoor



outdoor

**ACCESSORI**

Accessories / Accessoires

Pag. 234



Adatto per installazioni a parete e controsoffittature in cartongesso, anche per uso esterno. Idoneo per incassi da terra ad uso calpestabile, fissaggio mediante armatura da incasso fornita a parte.

Prodotto finalizzato all'impiego di sorgenti luminose a LED per luce di accento e segnalazione.

Corpo e ghiera in acciaio AISI316L. Diffusore in vetro temprato. Guarnizioni in silicone.

1.5 m di cavo di alimentazione HO5RN-F pre-cablato e bloccato tramite pressacavo in Ottone Nichelato.

La molla di ritenuta si adatta sia per applicazioni che prevedono l'utilizzo di armatura da incasso che direttamente in controsoffittature in cartongesso.

Dimmerazione disponibile. Bulloneria in acciaio inox A4 o AISI 316L.

**Versione in tensione costante 12/24V:** Tutti i cavi sono provvisti di una speciale guaina che protegge il faretto dalle infiltrazioni di acqua e umidità.

**Versione in corrente costante 350 mA/500 mA:** La speciale guaina che riveste il circuito protegge il faretto dalle infiltrazioni di acqua e umidità. Utilizzare esclusivamente alimentatori di tipo SELV o equivalenti.

**CNC35 versione in corrente costante 350 mA/ 500 mA:** tutti i cavi vengono forniti integrati di un sistema elettronico che consente il collegamento non polarizzato del faretto. Il dispositivo elettronico inoltre, impedisce l'interruzione di linee di faretti collegati in serie nel caso di guasto di un singolo prodotto. **LED 4000K (N), 3000K (3) o 2700K (2).**

**Alimentatore escluso. Nessun rischio fotobiologico, RGO gruppo di rischio esente (EN62471).**

**ENG** Suitable for installation on plasterboard walls and ceilings and for outdoor use. Ideal for recessed ground application, also for walk-over use. Installation by means of a recess box supplied separately. Product designed for LED light sources for accent lighting and marking driveways and pathways. Body and retaining ring made of stainless steel AISI 316L. Heat tempered glass diffuser. Silicone gaskets. 1.5 m. pre-wired cable type HO5RN-F, secured by means of a nickel-plated brass cable gland. The retaining spring adapts both to applications requiring the use of the recess box or for fittings directly on plasterboard ceilings. Dimmable version available. A4 or AISI 316L stainless steel nuts and bolts.

**Version in constant tension 12/24V:** all the wiring is supplied with a special sheathing protecting the spot from seepage of water and damp.

**Version in constant current 350mA/ 500mA:** the special sheathing covering the circuit protects the spot light from seepage of water and damp. Only drivers type SELV or equivalent must be used.

**CNC35 Version in constant current 350mA/ 500mA:** all the wiring is supplied with a built-in electronic system that allows a non-polarised connection of the spot light. Moreover, the electronic device prevents the interruption of whole rows of downlights connected together in the event of a fault on just one of the products.

**LED 4000K (N), 3000K (3) or 2700K (2). LED. Ballast not included. No risk of photobiological damage, RGO group (EN62471).**

**FRA** Également adapté pour les installations murales et les faux plafonds en placoplâtre et à l'usage à l'extérieur. Convient aussi pour une utilisation au sol piétonnable, fixation par une boîte d'encastrement fournie à part. Produit finalisé à l'emploi de sources lumineuses à LED pour éclairage d'accentuation et de signalisation. Corps et viroles en acier inox type AISI 316L. Diffuseur en verre trempé. Joints en silicone. Câble d'alimentation HO5RN-F de 1.5m pré-câblé et bloqué par un presse-câble en Laiton Nickelé. Le ressort de retenue s'adapte aussi bien pour des applications qui prévoient l'utilisation de boîte d'encastrement que pour des applications directement sur les faux-plafonds en placoplâtre. Version dimmable disponible. Fixation en acier inox type A4 ou AISI 316L.

**Version en tension 12/24V:** tous les câbles sont fournis avec une gaine spéciale qui protège le spot des infiltrations d'eau et d'humidité.

**Version en courant constant 350mA/ 500mA:** la gaine spéciale qui recouvre le circuit protège le spot des infiltrations d'eau et d'humidité. Utilisez exclusivement les drivers du type SELV ou équivalent.

**CNC35 Version en courant constant 350mA/ 500mA:** tous les câbles sont fournis avec intégration d'un système électronique qui permet le branchement de non polarisé du spot. En outre, le système électronique empêche l'interruption des lignes de spots connectés en série en cas de rupture d'un seul produit.

**LED 4000K (N), 3000K (3) ou 2700K (2) (blanche chaude). Alimentation déportée. Pas de risque photobiologique, RGO groupe (EN62471).**



**Outdoor  
e waterproof**



**Aquastop**



**Pre-cablato**  
Pre-wired  
Pré-câblé



**Anni di garanzia  
sul circuito LED**  
Years warranty on LED circuit  
Ans de garantie sur la source LED

# CNC 25

## CNC 25 T



DIFF.  
VETRO

IP 68 IK 10 20J xx9 CE UK CA 500 KG MAX 65°C MAX

LED	W	LM	REAL LM	COL.	CODE * *	€	* OPTIC	* LED COLOUR
2	180	Max 148	500mA - 4,8V		LL119000□□	84,00	M 30°	N 4000K
					LL119004□□	89,50	S 15°	3 3000K, Im -5%
					LL119006□□	89,50	D Diff.	2 2700K, Im -5%
2	180	Max 148	12/24V		LL119001□□	95,50		B Blue
					LL119005□□	101,00		
					LL119007□□	101,00		

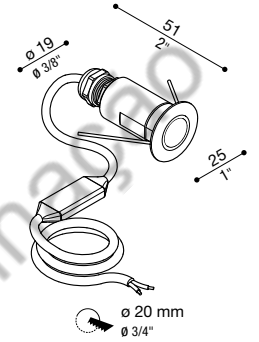

Versione ghiera tonda, possibile scelta di 2 differenti ottiche. Temperatura massima rilevata sul vetro 65°C. Idoneo per installazione in tubo corrugato standard Ø25 mm.

Version with round retaining ring, choice of 2 different optics. Max. temperature measured on the glass 65°C. Suitable for installation in standard Ø 25 mm corrugated duct.

Version avec virole ronde, choix possible de 2 optiques différentes. Température relevée sur le verre 65°C maxi. Convient pour une installation dans un tube annelé standard Ø25 mm.

## CNC 25 Q



DIFF.  
VETRO

IP 68 IK 10 20J xx9 CE UK CA 500 KG MAX 65°C MAX

LED	W	LM	REAL LM	COL.	CODE * *	€	* OPTIC	* LED COLOUR
2	180	Max 148	500mA - 4,8V		LL119002□□	93,50	M 30°	N 4000K
						93,50	S 15°	3 3000K, Im -5%
						93,50	D Diff.	2 2700K, Im -5%
2	180	Max 148	12/24V		LL119003□□	105,00		B Blue

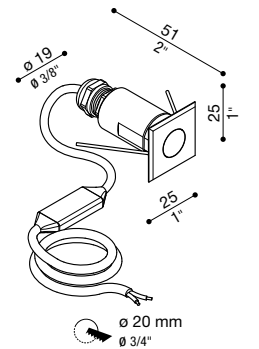

Versione ghiera quadra, possibile scelta di 2 differenti ottiche. Temperatura massima rilevata sul vetro 65°C. Idoneo per installazione in tubo corrugato standard Ø25 mm.

Version with square retaining ring, choice of 2 different optics. Max. temperature measured on the glass 65°C. Suitable for installation in standard Ø 25 mm corrugated duct.

Version avec virole carrée, choix possible de 2 optiques différentes. Température relevée sur le verre 65°C maxi. Convient pour une installation dans un tube annelé standard Ø25 mm.

## CNC 35 T



DIFF.  
VETRO

IP 68 IK 10 20J xx9 CE UK CA 500 KG MAX 65°C MAX

LED	W	LM	REAL LM	COL.	CODE * *	€	* OPTIC	* LED COLOUR
2	180	Max 148	500mA - 4,8V		LL107000□□	97,00	S 14°	N 4000K
					LL107032□□	102,00	M 29°	3 3000K, Im -5%
					LL107033□□	102,00	L 46°	2 2700K, Im -5%
2	180	Max 148	12/24V		LL107006□□	114,50	D Diff.	B Blue
					LL107034□□	119,00		
					LL107035□□	119,00		

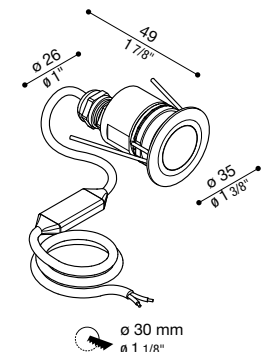

Versione ghiera tonda, possibile scelta di 3 differenti ottiche. Temperatura massima rilevata sul vetro 65°C.

Version with round retaining ring, choice of 3 different optics. Max. temperature measured on the glass 65°C.

Version avec virole ronde, choix possible de 3 optiques différentes. Température relevée sur le verre 65°C maxi.

# CNC 35



## CNC 35 T Up



DIFF. VETRO

IP68 IK 10 20J xx9 CE UK CA 1000 KG MAX 65°C MAX

LED	W	LM	REAL LM	COL.	CODE *	€	* LED COLOUR
	2	180	78	500mA - 4,8V	LL107024	97,00	N 4000K 3 3000K, Im -5% 2 2700K, Im -5% B Blue
	2	180	78	12/24V	LL107025	114,50	

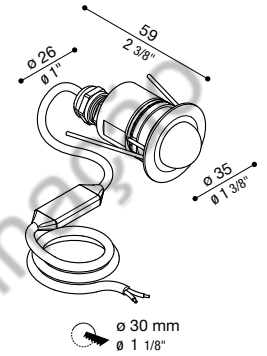

Versione con diffusore in vetro sporgente ad alta diffondenza. Temperatura massima rilevata sul vetro 65°C.

Version with protruding glass diffuser for high diffusion. Max. temperature measured on the glass 65°C.

Version avec diffuseur en verre saillant à diffusion élevée. Température relevée sur le verre 65°C maxi.

## CNC 35 Q



DIFF. VETRO

IP68 IK 10 20J xx9 CE UK CA 500 KG MAX 65°C MAX

LED	W	LM	REAL LM	COL.	CODE **	€	* OPTIC	* LED COLOUR
	2	180	Max148	500mA - 4,8V	LL107001	105,00	S 14° M 29° L 46° D Diff.	N 4000K 3 3000K, Im -5% 2 2700K, Im -5% B Blue
	2	180	Max148	12/24V	LL107007	122,50		

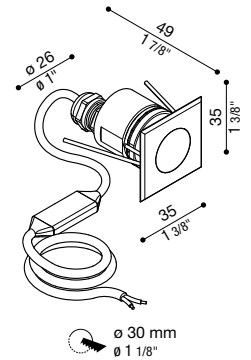

Versione ghiera quadra, possibile scelta di 3 differenti ottiche. Temperatura massima rilevata sul vetro 65°C.

Version with square retaining ring, choice of 3 different optics. Max. temperature measured on the glass 65°C.

Version avec virole carrée, choix possible de 3 optiques différentes. Température relevée sur le verre 65°C maxi.

## CNC 35 Q Up



DIFF. VETRO

IP68 IK 10 20J xx9 CE UK CA 1000 KG MAX 65°C MAX

LED	W	LM	REAL LM	COL.	CODE *	€	* LED COLOUR
	2	180	78	500mA - 4,8V	LL107026	105,00	N 4000K 3 3000K, Im -5% 2 2700K, Im -5% B Blue
	2	180	78	12/24V	LL107027	122,50	

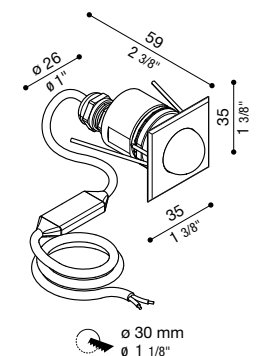

Versione con diffusore in vetro sporgente ad alta diffondenza. Temperatura massima rilevata sul vetro 65°C.

Version with protruding glass diffuser for high diffusion. Max. temperature measured on the glass 65°C.

Version avec diffuseur en verre saillant à diffusion élevée. Température relevée sur le verre 65°C maxi.



# CNC 35

## CNC 35 Top S



DIFF.  
VETRO

IP 68 IK 10 20J xx9 CE UK CA 500 KG MAX 65°C MAX

LED	W	LM	REAL LM		COL.	CODE *	€	* LED COLOUR
	2	180	12	⚡ 500mA - 4,8V		LL107002	108,50	<ul style="list-style-type: none"> <li>N 4000K</li> <li>3 3000K, lm -5%</li> <li>2 2700K, lm -5%</li> <li>B Blue</li> </ul>
	2	180	12	⚡ 12/24V		LL107008	126,50	

Versione ghiera Top con apertura a 45°. Temperatura massima rilevata sul vetro 65°C.

Version with Top retaining ring with 45° opening. Max. temperature measured on the glass 65°C.

Version avec virole Top ouverte à 45°. Température relevée sur le verre 65° C maxi.

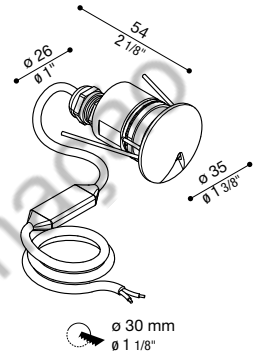

## CNC 35 Top L



DIFF.  
VETRO

IP 68 IK 10 20J xx9 CE UK CA 500 KG MAX 65°C MAX

LED	W	LM	REAL LM		COL.	CODE *	€	* LED COLOUR
	2	180	25	⚡ 500mA - 4,8V		LL107003	108,50	<ul style="list-style-type: none"> <li>N 4000K</li> <li>3 3000K, lm -5%</li> <li>2 2700K, lm -5%</li> <li>B Blue</li> </ul>
	2	180	25	⚡ 12/24V		LL107009	126,50	

Versione ghiera top con apertura a 135°. Temperatura massima rilevata sul vetro 65°C.

Version with Top retaining ring with 135° opening. Max. temperature measured on the glass 65°C.

Version avec virole Top ouverte à 135°. Température relevée sur le verre 65° C maxi.

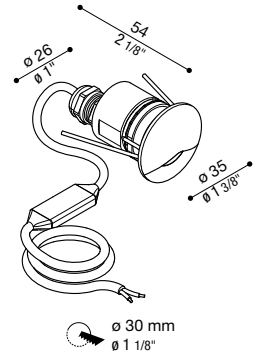

## CNC 35 Mask



DIFF.  
VETRO

IP 68 IK 10 20J xx9 CE UK CA 500 KG MAX 65°C MAX

LED	W	LM	REAL LM		COL.	CODE *	€	* LED COLOUR
	2	180	21	⚡ 500mA - 4,8V		LL107004	108,50	<ul style="list-style-type: none"> <li>N 4000K</li> <li>3 3000K, lm -5%</li> <li>2 2700K, lm -5%</li> <li>B Blue</li> </ul>
	2	180	21	⚡ 12/24V		LL107010	126,50	

Versione ghiera Mask con 4 aperture da 35°. Temperatura massima rilevata sul vetro 65°C.

Version with Mask retaining ring with four 35° openings. Max. temperature measured on the glass 65°C.

Version avec virole Mask 4 ouvertures à 35°. Température relevée sur le verre 65° C maxi.

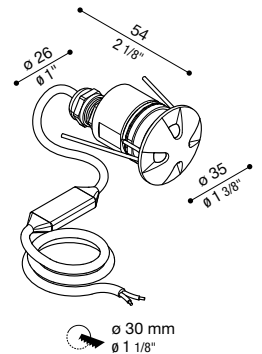



### CNC 35 Swing

DIFF. VETRO

IP 68 IK 07 2J xx5 CE UK CA 65° MAX

LED	W	LM	REAL LM	COL.	CODE **	€	* OPTIC	* LED COLOUR
2	180	Max 148	500mA - 4,8V		LL107005□□	127,50	S 14°	N 4000K
					LL107036□□	134,50	M 29°	3 3000K, Im -5%
					LL107037□□	134,50	L 46°	2 2700K, Im -5%
2	180	Max 148	12/24V		LL107011□□	145,00	D Diff.	B Blue
					LL107038□□	152,00		
					LL107039□□	152,00		

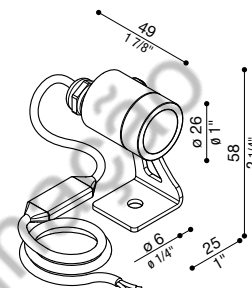

Versione orientabile. Picchetto non incluso, possibile scelta di 3 differenti ottiche. Temperatura massima rilevata sul vetro 65°C.

Swivel version. Stake not included, choice of 3 different optics. Max. temperature measured on the glass 65°C.

Version orientable. Piquet non compris, choix possible de 3 optiques différentes. Température relevée sur le verre 65°C maxi.

### CNC 35 Swing Spot

DIFF. VETRO

IP 68 IK 07 2J xx5 CE UK CA 65° MAX

LED	W	LM	REAL LM	COL.	CODE *	€	* LED COLOUR
2	180	Max 148	500mA - 4,8V		LL107028□	134,50	N 4000K
					LL107029□	152,00	3 3000K, Im -5%
2	180	Max 148	12/24V				2 2700K, Im -5%
							B Blue

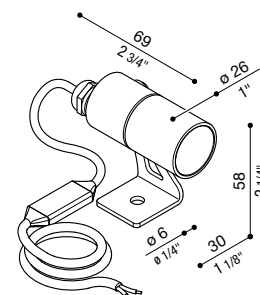

Versione orientabile antiabbagliamento. Picchetto non incluso. Temperatura massima rilevata sul vetro 65°C.

Adjustable anti-glare version. Stake not included. Maximum temperature measured on the glass 65°C.

Version orientable antiéblouissement. Piquet non compris. Température maximum relevée sur le verre 65°C

#### Finishing

Inox Lucido  
Polished stainless steel  
Inox brillant

Corten  
Corten  
Corten

Grigio antracite RAL 7021  
Grey anthracite RAL 7021  
Gris anthracite RAL 7021

#### \* Led colour

- N 4000K
- 3 3000K, Im -5%
- 2 2700K, Im -5%
- B Blue



**Completa il codice**  
sostituendo al quadrato rosso la lettera o il numero corrispondente alla temperatura colore scelta.

**Complete the code**  
by replacing the red box with the letter or number corresponding to the selected colour temperature.

**Compléter le code**  
en remplaçant le carré rouge par la lettre ou le numéro correspondant à la sélection de température couleur.

⊗ **Alimentatore escluso**  
Driver not included  
Alimentation non incluse

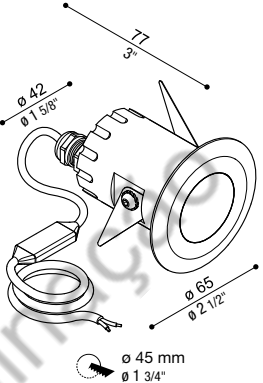

# CNC 50

<b>CNC 50 T</b>				<b>DIFF. VETRO</b>					
<b>IP 68 IK 10 20J xx9</b>		CE UK CA		500 <sup>KG</sup> MAX		65 <sup>°</sup> MAX			
<b>LED</b>	<b>W</b>	<b>LM</b>	<b>REAL LM</b>	<b>COL.</b>	<b>CODE * *</b>	<b>€</b>	<b>* OPTIC</b>	<b>* LED COLOUR</b>	
	6,5	650	Max 427		LL107016 □ □	134,50	S 13°	N 4000K	
					LL107040 □ □	138,00	M 24°	3 3000K, Im -5%	
					LL107041 □ □	138,00	L 53°	2 2700K, Im -5%	
					LL107017 □ □	149,00	D Diff.		
	6,5	650	Max 427		LL107042 □ □	156,50			
					LL107043 □ □	156,50			

Versione ghiera tonda, possibile scelta di 3 differenti ottiche. Temperatura massima rilevata sul vetro 65°C. Versione carrabile.

Version with round retaining ring, choice of 3 different optics. Max. temperature measured on the glass 65°C. Drive-over version.

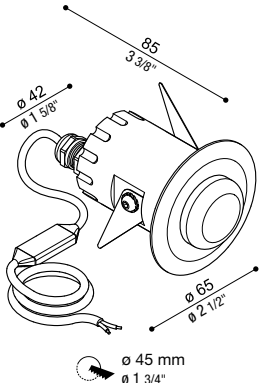

Version avec virole ronde, choix possible de 3 optiques différentes. Température relevée sur le verre 65° C maxi. Version carrossable.

<b>CNC 50 T Up</b>				<b>DIFF. VETRO</b>					
<b>IP 68 IK 10 20J xx9</b>		CE UK CA		450 <sup>KG</sup> MAX		65 <sup>°</sup> MAX			
<b>LED</b>	<b>W</b>	<b>LM</b>	<b>REAL LM</b>	<b>COL.</b>	<b>CODE *</b>	<b>€</b>	<b>* LED COLOUR</b>		
	6,5	650	269		LL107022 □	134,50	N 4000K		
							3 3000K, Im -5%		
							2 2700K, Im -5%		
	6,5	650	269		LL107023 □	149,00			

Versione con diffusore in vetro sporgente ad alta diffondenza. Temperatura massima rilevata sul vetro 65°C.

Version with protruding glass diffuser for high diffusion. Max. temperature measured on the glass 65°C.

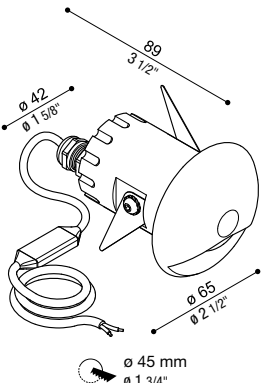
Version avec diffuseur en verre saillant à diffusion élevée. Température relevée sur le verre 65° C maxi.

<b>CNC 50 Top L</b>				<b>DIFF. VETRO</b>					
<b>IP 68 IK 10 20J xx9</b>		CE UK CA		65 <sup>°</sup> MAX		2000 <sup>KG</sup> MAX			
<b>LED</b>	<b>W</b>	<b>LM</b>	<b>REAL LM</b>	<b>COL.</b>	<b>CODE *</b>	<b>€</b>	<b>* LED COLOUR</b>		
	6,5	650	260		LL107018 □	156,50	N 4000K		
							3 3000K, Im -5%		
							2 2700K, Im -5%		
	6,5	650	260		LL107019 □	173,50			

Versione ghiera top con apertura a 110°. Temperatura massima rilevata sul vetro 65°C. Versione carrabile.

Version with Top retaining ring with 110° opening. Max. temperature measured on the glass 65°C. Drive-over version.

Version avec virole Top ouverture à 110°. Température relevée sur le verre 65° C maxi. Version carrossable.

## Finishing

 Inox Lucido  
Polished stainless steel  
Inox brillant

 Corten  
Corten  
Corten

 Grigio antracite RAL 7021  
Grey anthracite RAL 7021  
Gris anthracite RAL 7021

 **Alimentatore escluso**  
Driver not included  
Alimentation non incluse



### CNC 50 TOP 2L



DIFF. VETRO

IP68 IK 10 20J xx9 CE UK CA 2000 KG MAX 65°C MAX

LED	W	LM	REAL LM	COL.	CODE *	€	* LED COLOUR
	6,5	650	453	500mA - 14V	LL107020	156,50	N 4000K 3 3000K, lm -5% 2 2700K, lm -5%
	6,5	650	453	24V	LL107021	173,50	

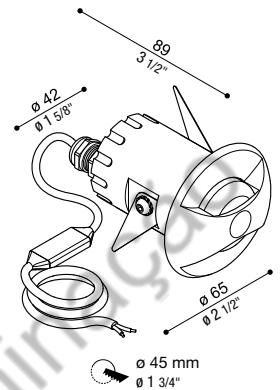

Versione ghiera con 2 aperture da 110°. Temperatura massima rilevata sul vetro 65°C. Versione carrabile.

Version with Top retaining ring with two 110° openings. Max. temperature measured on the glass 65°C. Drive-over version.

Version avec virole Top 2 ouvertures à 110°. Température relevée sur le verre 65°C maxi. Version carrossable.

### CNC 50 Swing

DIFF. VETRO

IP68 IK 07 2J xx5 CE UK CA 65°C MAX

LED	W	LM	REAL LM	COL.	CODE **	€	* OPTIC	* LED COLOUR
	6,5	650	Max 427	500mA - 14V	LL107012	186,00	S 13°	N 4000K
					LL107044	193,50	M 24°	3 3000K, lm -5%
					LL107045	193,50	L 53°	2 2700K, lm -5%
	6,5	650	Max 427	24V	LL107013	205,00	D Diff.	
					LL107046	210,50		
					LL107047	210,50		

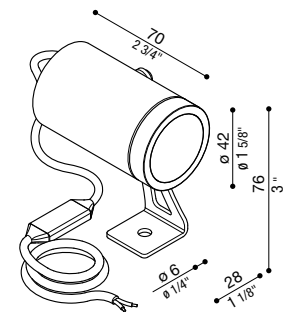

Versione orientabile. Picchetto non incluso, possibile scelta di 3 differenti ottiche. Temperatura massima rilevata sul vetro 65°C.

Swivel version. Stake not included, choice of 3 different optics. Max. temperature measured on the glass 65°C.

Version orientable. Piquet non compris, choix possible de 3 optiques différentes. Température relevée sur le verre 65°C maxi.

### CNC 50 Swing Spot

DIFF. VETRO

IP68 IK 07 2J xx5 CE UK CA 65°C MAX

LED	W	LM	REAL LM	COL.	CODE *	€	* LED COLOUR
	6,5	650	Max 488	500mA - 14V	LL107030	193,50	N 4000K 3 3000K, lm -5% 2 2700K, lm -5%
	6,5	650	Max 488	24V	LL107031	210,50	

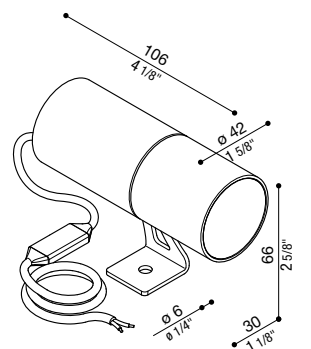

Versione orientabile antiabbagliamento. Picchetto non incluso. Temperatura massima rilevata sul vetro 65°C.

Adjustable anti-glare version. Stake not included. Maximum temperature measured on the glass 65°C.

Version orientable antiéblouissement. Piquet non compris. Température maximum relevée sur le verre 65°C.

**\* Led colour**

- N 4000K
- 3 3000K, lm -5%
- 2 2700K, lm -5%

**Completa il codice** sostituendo al quadrato rosso la lettera o il numero corrispondente alla temperatura colore scelta.

**Complete the code** by replacing the red box with the letter or number corresponding to the selected colour temperature.

**Compléter le code** en remplaçant le carré rouge par la lettre ou le numéro correspondant à la sélection de température couleur.

**\* Optic**



**Completa il codice** sostituendo al quadrato grigio la lettera corrispondente al modello di ottica scelta.

**Complete the code** by replacing the grey box with the letter corresponding to the selected optic model.

**Compléter le code** en remplaçant le carré gris par la lettre correspondante au modèle de lentille choisie.

# CNC 25-35-50

## ACCESSORI

Accessories / Accessoires

### Armatura da incasso CNC 25

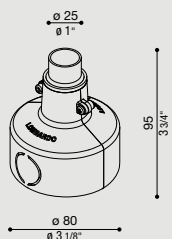

Armatura da incasso in termoplastico.

*Thermoplastic recess box  
CNC 25*

*Thermoplastic recess box.*

*Armature à encastrer CNC 25  
Armature à encastrer en matériau  
thermoplastique.*

COL.	CODE	€
	<b>LB1190001</b>	<b>5,80</b>

### Armatura da incasso CNC 35

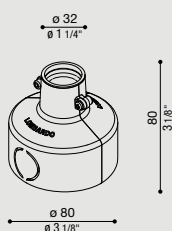

Armatura da incasso in termoplastico.

*Thermoplastic recess box  
CNC 35*

*Thermoplastic recess box.*

*Armature à encastrer CNC 35  
Armature à encastrer en matériau  
thermoplastique.*

COL.	CODE	€
	<b>LB1070001</b>	<b>5,80</b>

### Armatura da incasso CNC 50

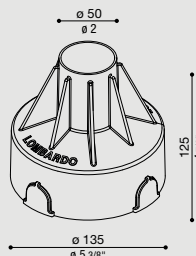

Armatura da incasso in termoplastico.

*Recess box CNC 50  
Thermoplastic recess box.*

*Boîte d'encastrement CNC 50  
Armature à encastrer en matériau  
thermoplastique.*

COL.	CODE	€
	<b>LB1070039</b>	<b>5,80</b>

### Accessorio giardino CNC 35 - CNC 50



Accessorio da giardino da abbinare a CNC35 Swing / CNC50 Swing, realizzato in metallo zincato a freddo. Adatto per uso esterno. Idoneo per installazione a terra.

*Garden accessory  
CNC35 - CNC50  
Garden accessory for use with CN  
C35 Swing / CNC50 Swing, made  
of cold galvanized metal. Suitable  
for outdoor use and ground  
application.*

*Accessoire de jardin  
CNC35 - CNC50  
Accessoire de jardin à associer  
à CNC35 Swing / CNC50 Swing,  
réalisé en métal zingué à froid.  
Egalement adapté à l'usage à  
l'extérieur. Convient pour une  
utilisation au sol.*

COL.	CODE	€
	<b>LB1070002</b>	<b>17,50</b>





**ACCESSORI**

Accessories / Accessoires

**Alimentatori CNC 25/35 in corrente costante**

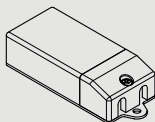

CNC 25/35 ballasts in constant current

Alimentations CNC 25/35 en courant constant

350mA				500mA			
N° max fixtures	IP	CODE	€	N° max fixtures	IP	CODE	€
1/2	20	LB1070008	28,00	1/2	20	LB1070015	33,00
1/3	20	LB1070009	33,00	1/3	20	LB1070016	40,50
5/10	20	LB1070011	46,00	5/10	20	LB1070018	47,00
1/12 1-10 PUSH	20	LB1070012	69,00	1/12 1-10 PUSH	20	LB1070019	67,50
2/4	67	LB1070013	30,00	1/4	67	LB1070020	44,50
5/10	67	LB1070014	44,50	5/10	67	LB1070021	76,00
3/9 DALI	20	LB1070064	88,00	3/9 DALI	20	LB1070064	88,00

**Alimentatori CNC 50 in corrente costante**

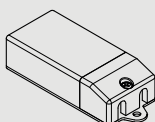

CNC 50 ballasts in constant current

Alimentations CNC 50 en courant constant

350mA				500mA			
N° max fixtures	IP	CODE	€	N° max fixtures	IP	CODE	€
1	20	LB1070009	33,00	1	20	LB1070016	40,50
1/3	20	LB1070011	46,00	1/3	20	LB1070018	47,00
1/3 1-10 PUSH	20	LB1070012	69,00	1/4 1-10 PUSH	20	LB1070019	67,50
1/2	67	LB1070013	30,00	1/2	67	LB1070020	44,50
1/3	67	LB1070014	44,50	1/4	67	LB1070021	76,00
1/3 DALI	20	LB1070064	88,00	1/3 DALI	20	LB1070064	88,00

**Alimentatore CNC in tensione costante 12/24V**

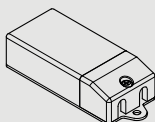

CNC ballasts in constant tension 12/24V

Alimentations CNC en tension 12/24V

12V				24V				
N° max	IP	CODE	€	N° max	IP	CODE	€	
CNC 25/35				CNC 25/35    CNC 50				
1/6	20	LB1070025	34,00	1/6	1/2	20	LB1070029	40,50
1/12	20	LB1070026	50,00	1/12	1/4	20	LB1070030	50,00
1/8	67	LB1070027	37,50	1/8	1/2	67	LB1070031	37,50
1/15	67	LB1070028	52,50	1/15	1/7	67	LB1070032	52,50

**Cavo H05RN-F 2x0,75**



Cavo H05RN-F in Neoprene, sezione 2x0,75. Adatto ad uso esterno.

Cable type H05RN-F 2x0,75  
Cable type H05RN-F in Neoprene, section 2x0,75. Suitable for outdoor use.

Câble H05RN-F 2x0,75  
Câble H05RN-F en Néoprène, section 2x0,75. Egalement adapté à l'usage à l'extérieur.

5 m		15 m	
CODE	€	CODE	€
LB1070004	11,00	LB1070006	33,00
10 m		20 m	
CODE	€	CODE	€
LB1070005	22,00	LB1070007	42,00



# CNC 25-35-50



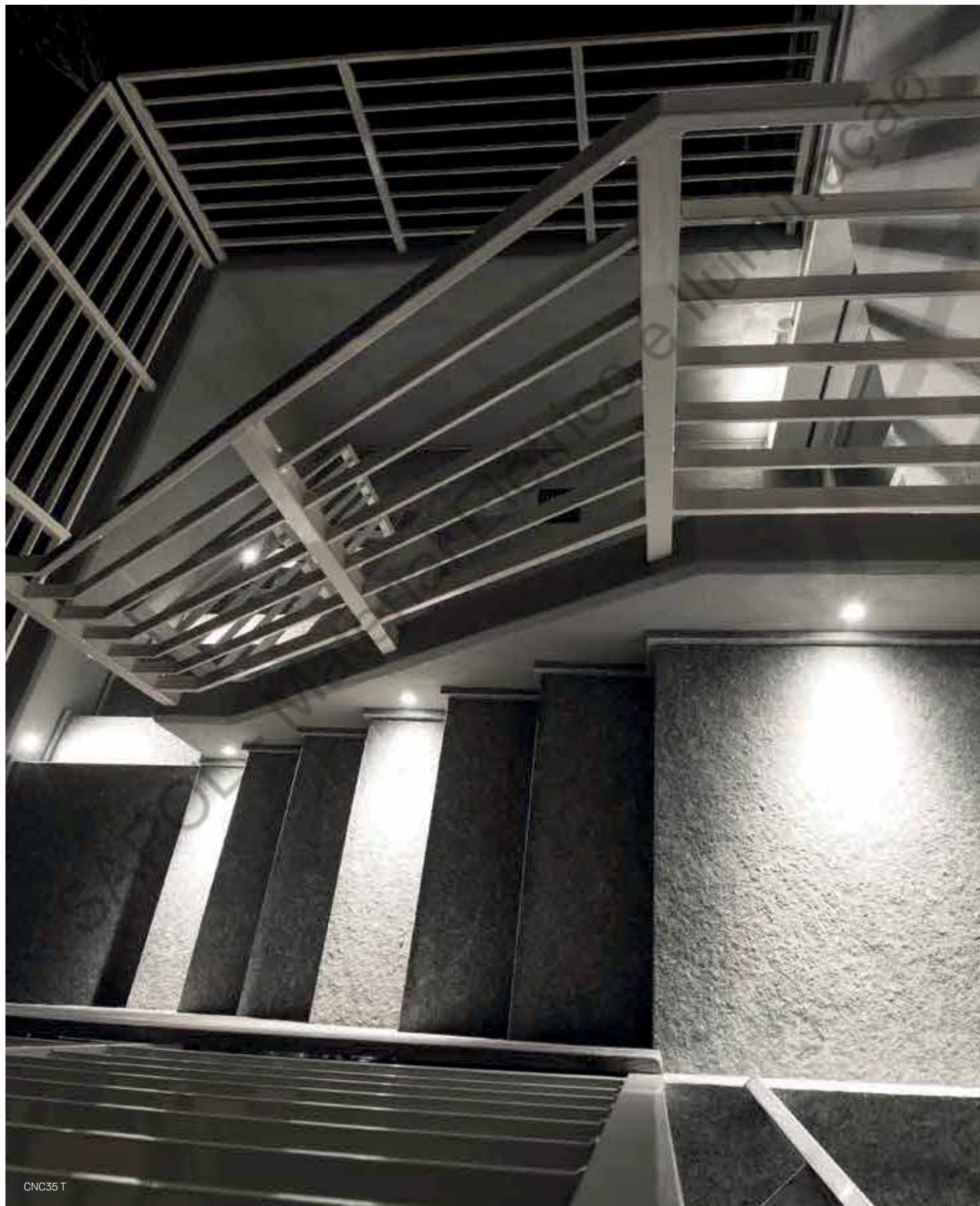

# CNC 99

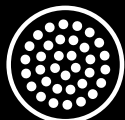

LED



outdoor

**ACCESSORI**

Accessories / Accessoires

Pag. 242



Adatto per installazioni a terra e parete per uso esterno. Fissaggio diretto a terra o mediante armatura da incasso fornita a parte. Prodotto finalizzato all'impiego di sorgenti luminose a LED per luce di accento e segnalazione. Corpo e ghiera in alluminio tornito. Diffusore in PMMA trasparente. Guarnizioni in silicone. 0,5 m di cavo di alimentazione H05RN-F pre-cablato e bloccato tramite pressacavo in Ottone Nichelato. Bulloneria in acciaio inox A4 o AISI 316L. Provvisto di acqua stop integrato che protegge il prodotto dalle infiltrazioni di acqua e umidità.

**Nessun rischio fotobiologico, RGO gruppo di rischio esente (EN62471).**

**LED 4000K (N), 3000K (3) o 2700K (2). Alimentazione 24V alimentatore escluso.**

**ENG** Suitable for ground and wall installation and for outdoor use. Installation directly to the ground or by means of recess box supplied separately. Product designed for LED light sources for accent lighting and making driveways and pathways. Turned aluminium body and retaining ring. Transparent PMMA diffuser. Silicone gaskets. 0.5 m of H05RN-F power cable pre-wired and secured by means of a nickel-plated brass cable gland. A4 or AISI 316L stainless steel nuts and bolts. Product supplied with water-stop device to protect it from water and humidity infiltration.

No photobiological risk, RGO risk group (EN62471).

LED 4000K (N), 3000K (3) or 2700K (2). Ballast 24V power supply not included.

**FRA** Également adapté pour les installations murales et le plafonds et à l'usage à l'extérieur. Fixation par une boîte d'un d'encastrement fournie à part. Produit finalisé à l'emploi de sources lumineuses LED pour éclairage d'accentuation et de signalisation. Corps et viroles en acier inox type AISI 316L. Corps en aluminium tourné EN-6061 T6. Diffuseur PMMA transparent. Joints en silicone. Câble d'alimentation H05RN-F de 0,5 m pré-câblé et bloqué par un presse-câble en laiton nickelé. Fixation en acier inox type AISI 316L. Dispositif d'arrêt intégré qui protège le produit contre les infiltrations d'eau et d'humidité.

Pas de risque photobiologique, RGO groupe (EN62471)

LED 4000K (N), 3000K (3) et 2700K (2). Alimentation 24V. Alimentation déportée.

**CNC 99 CL**



**CNC 99 C2L**



**CNC 99 C4L**



**Outdoor  
e waterproof**

**CNC 99 C180**



**CNC 99 C UP**



**Dimmerabile**

Dimmable  
Dimmable



**Aquastop**



**Pre-cablato**

Pre-wired  
Pré-câblé

**Finto incasso.** Surface mounted. Faux encastré.

Cavo di alimentazione  
Power cable  
Câble d'alimentation

Pavimentazione  
Floor  
Sol

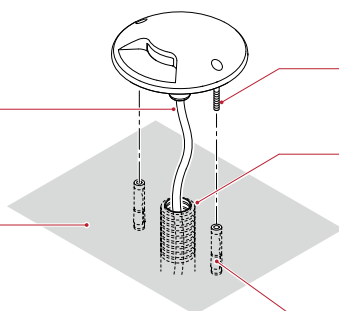

Tasselli M4  
Anchor screws M4  
Chevilles M4

Tubo corrugato  
Corrugated duct  
Tube annelé

Fissaggio tramite tasselli ad espansione ø8 mm  
Fixing by means of anchor screws ø8 mm  
Fixation par chevilles à expansion ø8 mm



**Anni di garanzia sul circuito LED**

Years warranty on LED circuit  
Ans de garantie sur la source LED



# CNC 99

## CNC 99 CL



DIFF.  
TRASP.

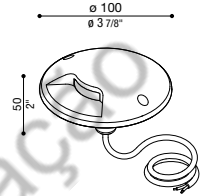

IP 67 IK 10 20J xx9 CE UK CA 2000 KG MAX 55° MAX

LED	W	LM	REAL LM	COL.	CODE *	€	* LED COLOUR
5	450	45	24V		LL137000□	256,00	N 4000K
					LL13700W□	209,00	3 3000K, lm -5%
					LL13700G□	209,00	2 2700K, lm -5%
					LL13700E□	209,00	
					LL13700K□	209,00	

Versione monoemissione.  
Cod. LL137000N/3/2 ghiera in acciaio inox.  
Temperatura massima rilevata sulla visiera 55°C.

Unidirectional version.  
Cod. LL137000N/3/2 stainless steel retaining ring.  
Max. temperature measured on the eyelid 45°C.

Version unidirectionnelle.  
Cod. LL137000N/3/2 collerette en acier inox.  
Température relevée sur le casquette 55°C maxi.

## CNC 99 C2L



DIFF.  
TRASP.

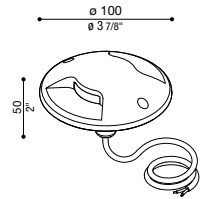

IP 67 IK 10 20J xx9 CE UK CA 2000 KG MAX 55° MAX

LED	W	LM	REAL LM	COL.	CODE *	€	* LED COLOUR
5	450	100	24V		LL137010□	256,00	N 4000K
					LL13701W□	209,00	3 3000K, lm -5%
					LL13701G□	209,00	2 2700K, lm -5%
					LL13701E□	209,00	
					LL13701K□	209,00	

Versione biemissione.  
Cod. LL137010N/3/2 ghiera in acciaio inox.  
Temperatura massima rilevata sulla visiera 55°C.

Bidirectional version.  
Cod. LL137010N/3/2 stainless steel retaining ring.  
Max. temperature measured on the eyelid 45°C.

Version bidirectionnelle.  
Cod. LL137010N/3/2 collerette en acier inox.  
Température relevée sur le casquette 55°C maxi.

## CNC 99 C4L



DIFF.  
TRASP.

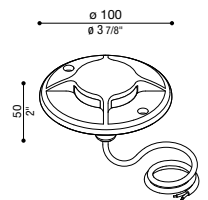

IP 67 IK 10 20J xx9 CE UK CA 2000 KG MAX 55° MAX

LED	W	LM	REAL LM	COL.	CODE *	€	* LED COLOUR
5	450	200	24V		LL137020□	268,00	N 4000K
					LL13702W□	221,00	3 3000K, lm -5%
					LL13702G□	221,00	2 2700K, lm -5%
					LL13702E□	221,00	
					LL13702K□	221,00	

Versione con quattro aperture.  
Cod. LL137020N/3/2 ghiera in acciaio inox.  
Temperatura massima rilevata sulla visiera 55°C.

Version with four openings.  
Cod. LL137020N/3/2 stainless steel retaining ring.  
Max. temperature measured on the eyelid 45°C.

Version avec quatre ouvertures.  
Cod. LL137020N/3/2 collerette en acier inox.  
Température relevée sur le casquette 55°C maxi.



### CNC 99 C180



DIFF. TRASP.

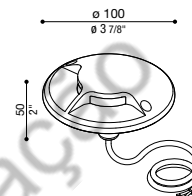

IP67 IK 10 20J xx9 CE UK CA 2000 KG MAX 55° MAX

LED	W	LM	REAL LM	COL.	CODE *	€	* LED COLOUR
5	450	93	24V		LL137030□	268,00	N 4000K
					LL13703W□	221,00	3 3000K, lm -5%
					LL13703G□	221,00	2 2700K, lm -5%
					LL13703E□	221,00	
					LL13703K□	221,00	

Versione a 180°. Cod. LL137030N/3/2 ghiera in acciaio inox. Temperatura massima rilevata sulla visiera 55°C.

180° version. Cod. LL137030N/3/2 stainless steel retaining ring. Max. temperature measured on the eyelid 45°C.

Version 180°. Cod. LL137030N/3/2 collerette en acier inox. Température relevée sur le casquette 55° C maxi.

### CNC 99 C UP



DIFF. POLIGLASS

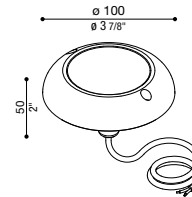

IP67 IK 10 20J xx9 CE UK CA 500 KG MAX 45° MAX

LED	W	LM	REAL LM	COL.	CODE *	€	* LED COLOUR
5	450	93	24V		LL137040□	256,00	N 4000K
					LL13704W□	209,00	3 3000K, lm -5%
					LL13704G□	209,00	2 2700K, lm -5%
					LL13704E□	209,00	
					LL13704K□	209,00	

Cod. LL137040N/3/2 ghiera in acciaio inox. Temperatura massima rilevata sul vetro 45°C. Diffusore in policarbonato, effetto poliGLASS.

Cod. LL137040N/3/2 stainless steel retaining ring. Max. temperature measured on the glass 45°C. Polycarbonate diffuser, polyGLASS effect.

Cod. LL137040N/3/2 collerette en acier inox. Température relevée sur le verre 45° C maxi. Diffuseur en polycarbonate, effet polyGLASS.

#### Finishing

Inox Lucido  
Polished stainless steel  
Inox brillant

Bianco RAL 9010  
White RAL 9010  
Blanc RAL 9010

Grigio High Tech RAL 9006  
Grey High Tech RAL 9006  
Gris High Tech RAL 9006

Grigio antracite RAL 7021  
Grey anthracite RAL 7021  
Gris anthracite RAL 7021

Corten  
Corten  
Corten

#### \* Led colour

- N 4000K
- 3 3000K, lm -5%
- 2 2700K, lm -5%
- B Blue

**Completa il codice**  
sostituendo al quadrato rosso la lettera o il numero corrispondente alla temperatura colore scelta.

**Complete the code**  
by replacing the red box with the letter or number corresponding to the selected colour temperature.

**Compléter le code**  
en remplaçant le carré rouge par la lettre ou le numéro correspondant à la sélection de température couleur.

**⊗ Alimentatore escluso**  
Driver not included  
Alimentation non incluse

# CNC 99

## ACCESSORI

Accessories / Accessoires

### Armatura da incasso CNC100

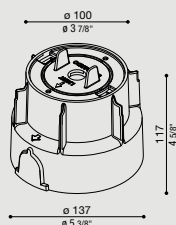

Armatura da incasso in termoplastico.

Thermoplastic recess box  
CNC100  
Thermoplastic recess box.

Armature à encastrer CNC100  
Armature à encastrer en matériau  
thermoplastique.

COL.	CODE	€
	LB1230001	11,50

### Cavo H05RN-F 2x0,75

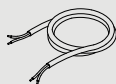

Cavo H05RN-F in Neoprene, sezione 2x0,75. Adatto ad uso esterno.

Cable type H05RN-F 2x0,75  
Cable type H05RN-F in Neoprene,  
section 2x0,75. Suitable for outdoor  
use.

Câble H05RN-F 2x0,75  
Câble H05RN-F en Néoprène,  
section 2x0,75. Egalement adapté  
à l'usage à l'extérieur.

5 m	10 m	15 m	20 m
CODE	CODE	CODE	CODE
€	€	€	€
LB1070004 11,00	LB1070005 22,00	LB1070006 33,00	LB1070007 42,00

### Alimentatore CNC in tensione costante 24V

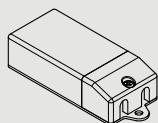

CNC ballasts in constant  
tension 24V

Alimentations CNC  
en tension 24V

N° max	IP	CODE	€
1/5	20	LB1070029	40,50
1/8	20	LB1070030	50,00
1/5	67	LB1070031	37,50
1/10	67	LB1070032	52,50
1/6 DALI	20	LB1070065	103,00

Morsettiere  
Terminal blocks



Scaricatori SPD  
Surge protector devices



Pag. 448



Versioni disponibili  
Available versions  
Versions disponibles



\* Versione in acciaio inox - Stainless steel version - Version en acier inox



CNC 99 CL



CNC 99 C4L



# CNC 99







Iluminação



CNC 99 C4L

# CNC 100



LED

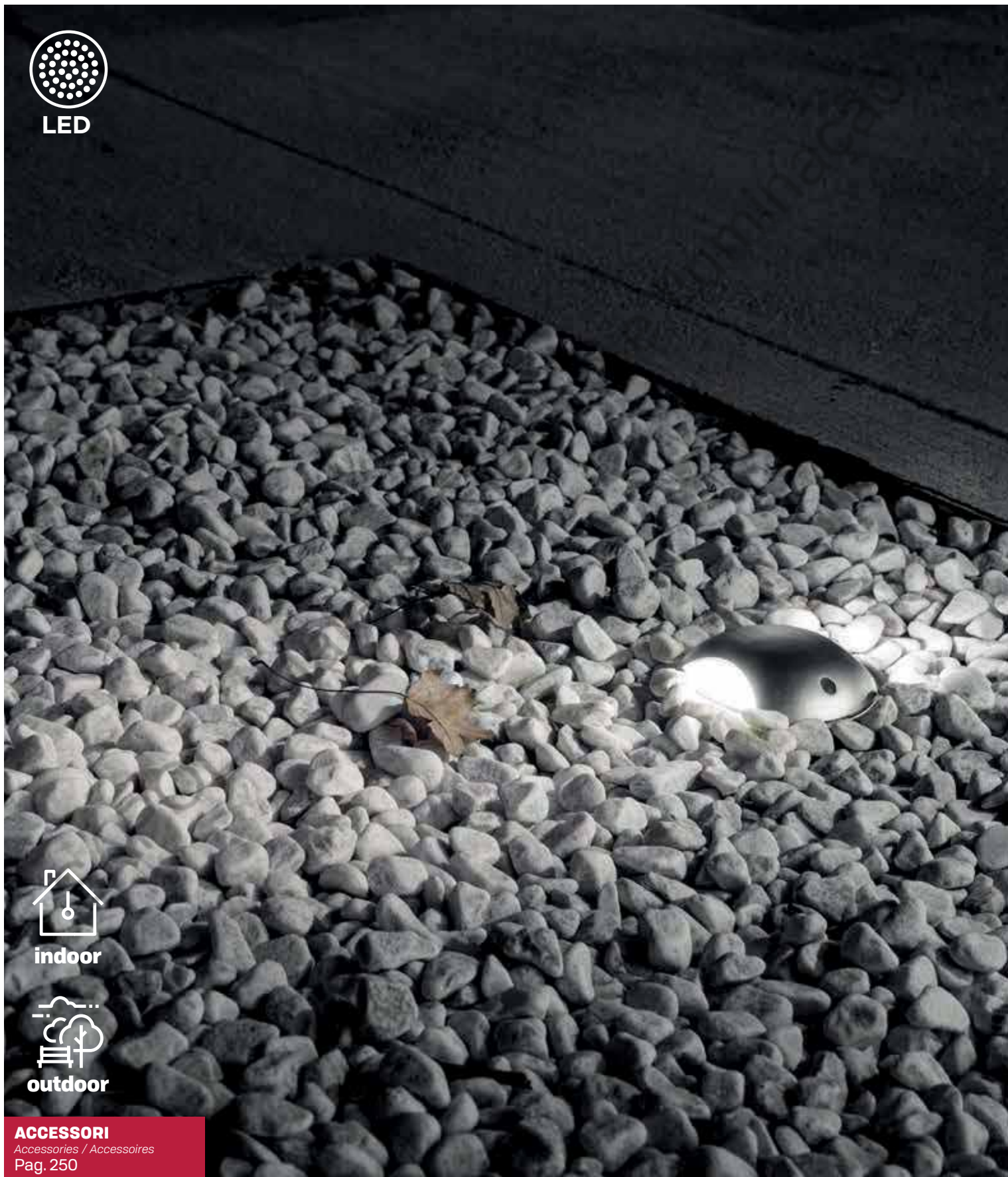

indoor



outdoor

**ACCESSORI**

Accessories / Accessoires

Pag. 250





Adatto per installazioni a pavimento e parete, anche per uso esterno. Idoneo per incassi da terra ad uso carrabile, fissaggio mediante armatura da incasso fornita a parte, ad eccezione del modello CNC 100 C che non necessita di controcassa. Prodotto finalizzato all'impiego di sorgenti luminose a LED per luce di accento e segnalazione. Corpo in alluminio anodizzato e ghiera in acciaio AISI316L. Diffusore in policarbonato. Guarnizioni in silicone. 1.5 m di cavo di alimentazione H05RN-F pre-cablato e bloccato tramite pressacavo in Ottone Nichelato. Bulloneria in acciaio inox A4 o AISI 316L. Tutti i cavi sono provvisti di una speciale guaina che protegge il faretto dalle infiltrazioni di acqua e umidità.

**Nessun rischio fotobiologico, RG0 gruppo di rischio esente (EN62471).**

CNC 100 L / CNC 100 2L / CNC 100 UP: Apertura e chiusura a scatto senza viti. **LED 4000K (N), 3000K (3) o 2700K (2).**

**Alimentazione diretta 220-240V.**

CNC 100 C L / CNC 100 C 2L: Versione in corrente costante 700 mA. Utilizzare esclusivamente alimentatori di tipo SELV o equivalenti. **LED 4000K (N), 3000K (3) o 2700K (2). Alimentatore escluso.**

CNC 100 C-UP: LED a tensione di rete. **LED 4000K (N), 3000K (3) o 2700K (2). Alimentazione diretta 220-240V.**

**ENG** Suitable for installation on floor and walls, also for outdoor use. Ideal for recessed ground application, also for drive-over use. Installation by means of a recess box supplied separately. Except for CNC 100 C, which does not require a recess box. Product designed for LED light sources for accent lighting and marking driveways and pathways. Anodised aluminium body and AISI316L steel retaining ring. Heat polycarbonate diffuser. Silicone gaskets. 1.5 m. pre-wired cable type H05RN-F, secured by means of a nickel-plated brass cable gland. A4 or AISI 316L stainless steel nuts and bolts. All the wiring is supplied with a special sheathing protecting the spot from seepage of water and damp.

**No risk of photobiological damage, RG0 group (EN62471).**

CNC 100 L / CNC 100 2L / CNC 100 UP: Snaps open and closed without screws. **LED 4000K (N), 3000K (3) or 2700K (2).**

**Integral ballast 220-240V.**

CNC 100 C L / CNC 100 C 2L: Version in constant current 700 mA.

Only drivers type SELV or equivalent must be used.

**LED 4000K (N), 3000K (3) or 2700K (2). Ballast not included.**

CNC 100 C-UP: LED AC Direct.

**LED 4000K (N), 3000K (3) or 2700K (2). LED AC Direct.**

**FRA** Également adapté pour les installations au sol et au mur, et à l'usage à l'extérieur. Convient aussi pour une utilisation au sol carrossable, fixation par une boîte d'encastrement fournie à part. Sauf pour le modèle CNC 100 C qui n'a pas besoin de la boîte d'encastrement.

Produit finalisé à l'emploi de sources lumineuses à LED pour éclairage d'accentuation et de signalisation. Corps en aluminium anodisé et bague de fixation en acier AISI316L. Diffuseur en polycarbonate. Joints en silicone. Câble d'alimentation H05RN-F de 1.5m pré-câblé et bloqué par un presse-câble en Laiton Nickelé. Fixation en acier inox type A4 ou AISI 316L. Tous les câbles sont fournis avec une gaine spéciale qui protège le spot des infiltrations d'eau et d'humidité. **Pas de risque photobiologique, RG0 groupe (EN62471).**

CNC 100 L / CNC 100 2L / CNC 100 UP : Ouverture et fermeture à déclic sans vis. **LED 4000K (N), 3000K (3) ou 2700K (2) (blanche chaud).**

**Alimentation intégrée 220-240.**

CNC 100 CL / CNC 100 C 2L : Version en courant constant 700mA.

Utilisez exclusivement les drivers du type SELV ou équivalent. **LED 4000K (N), 3000K (3), ou 2700K (2) (blanche chaud). Alimentation excluse.**

CNC 100 C-UP : LED Direct AC.

**LED 4000K (N), 3000K (3) ou 2700K (2) (blanche chaud). LED Direct AC.**



**Outdoor  
e waterproof**



**Aquastop**



**Anni di garanzia  
sul circuito LED**

Years warranty on LED circuit

Ans de garantie sur la source LED



LED a tensione di rete  
LED AC Direct  
LED Direct AC



LED posto verticalmente  
LED vertically mounted  
LED monté verticalement

**Incasso.** Recessed. À encastrer.

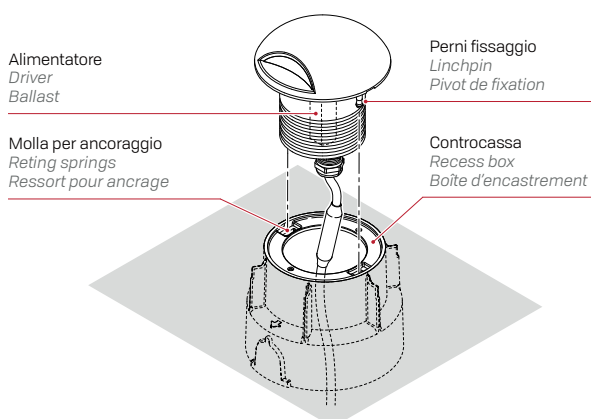

**Finto incasso.** Surface mounted. Faux encastré.

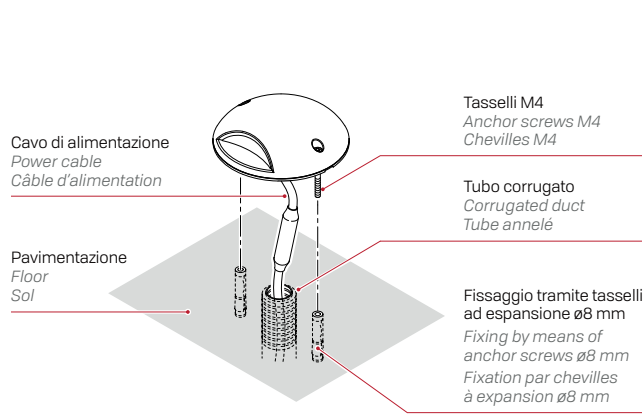

# CNC 100

## CNC 100 L

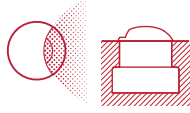

DIFF.  
SEMITRASP.

IP 68 IK 10 20J xx9 CE UK CA 2000 KG MAX 50°C MAX

LED	W	LM	REAL LM	COL.	CODE *	€	* LED COLOUR
					LL123000	214,00	N 4000K
					LL123001	220,00	3 3000K, lm -5%
					LL123002	220,00	2 2700K, lm -5%
					LL123003	220,00	
					LL123004	220,00	

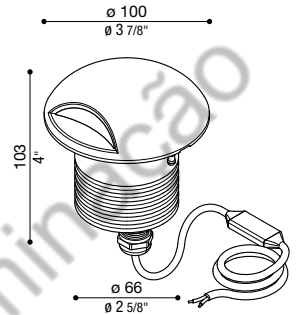

Versione ghiera top con apertura a 110°. Temperatura massima rilevata sul diffusore 50°C.  
Cavo H05RN-F 3x1.

Version with Top retaining ring with 110° opening. Max. temperature measured on the diffuser 50°C.  
Cable type H05RN-F 3x1.

Version avec virole Top ouverture à 110°. Température relevée sur le diffuseur 50° C maxi.  
Câble H05RN-F 3x1.

## CNC 100 2L



DIFF.  
SEMITRASP.

IP 68 IK 10 20J xx9 CE UK CA 2000 KG MAX 50°C MAX

LED	W	LM	REAL LM	COL.	CODE *	€	* LED COLOUR
					LL123005	214,00	N 4000K
					LL123006	220,00	3 3000K, lm -5%
					LL123007	220,00	2 2700K, lm -5%
					LL123008	220,00	
					LL123009	220,00	

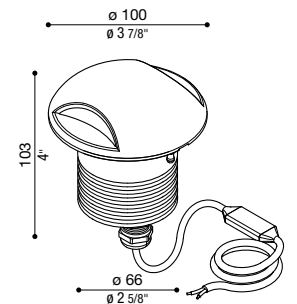

Versione ghiera con 2 aperture da 110°. Temperatura massima rilevata sul diffusore 50°C.  
Cavo H05RN-F 3x1.

Version with Top retaining ring with two 110° openings. Max. temperature measured on the diffuser 50°C.  
Cable type H05RN-F 3x1.

Version avec virole Top 2 ouvertures à 110°. Température relevée sur le diffuseur 50° C maxi.  
Câble H05RN-F 3x1.

## CNC 100 UP



DIFF.  
POLIGLASS

IP 68 IK 10 20J xx9 CE UK CA 280 KG MAX 50°C MAX

LED	W	LM	REAL LM	COL.	CODE *	€	* LED COLOUR
					LL123010	182,00	N 4000K
					LL123011	190,00	3 3000K, lm -5%
					LL123012	190,00	2 2700K, lm -5%
					LL123013	190,00	
					LL123014	190,00	

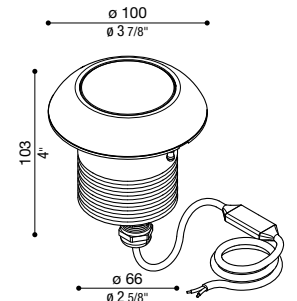

Emissione luminosa a 120°. Temperatura massima rilevata sul diffusore 50°C. Versione calpestabile.  
Cavo H05RN-F 3x1.

Light beam 120°. Max. temperature measured on the diffuser 50°C. Walk-over version.  
Cable type H05RN-F 3x1.

Angle de diffusion 120°. Température relevée sur le diffuseur 50° C maxi. Version piétinabile.  
Câble H05RN-F 3x1.



### CNC 100 CL

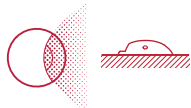

**DIFF. SEMITRASP.**

Fino ad esaurimento.  
Until our stock lasts.  
Jusqu'à épuisement de stock.

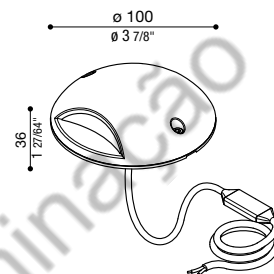

IP68 IK 10 20J xx9 CE UK CA 2000 KG MAX 50°C MAX

LED	W	LM	REAL LM	COL.	CODE *	€	* LED COLOUR
3	215	103	700mA - 3,10V		LL123015□	172,50	N 4000K
					LL123016□	181,00	3 3000K, Im -5%
					LL123017□	181,00	2 2700K, Im -5%
					LL123018□	181,00	
					LL123019□	181,00	

Versione ghiera top con apertura a 110°. Temperatura massima rilevata sul diffusore 50°C. Completo di kit di fissaggio tramite tasselli ad espansione Ø8 mm. Cavo H05RN-F 2x0,75.

Version with Top retaining ring with 110° opening. Max. temperature measured on the diffuser 50°C. Complete with fixing kit by means of anchor screws Ø8 mm. Cable type H05RN-F 2x0,75.

Version avec virole Top ouverture à 110°. Température relevée sur le diffuseur 50° C maxi. Complet de kit de fixation par chevilles à expansion Ø8 mm. Câble H05RN-F 2x0,75.

### CNC 100 C2L



**DIFF. SEMITRASP.**

Fino ad esaurimento.  
Until our stock lasts.  
Jusqu'à épuisement de stock.

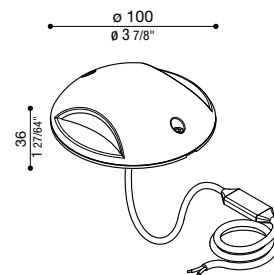

IP68 IK 10 20J xx9 CE UK CA 2000 KG MAX 50°C MAX

LED	W	LM	REAL LM	COL.	CODE *	€	* LED COLOUR
5	430	205	700mA - 6,20V		LL123020□	172,50	N 4000K
					LL123021□	181,00	3 3000K, Im -5%
					LL123022□	181,00	2 2700K, Im -5%
					LL123023□	181,00	
					LL123024□	181,00	

Versione ghiera con 2 aperture da 110°. Temperatura massima rilevata sul diffusore 50°C. Completo di kit di fissaggio tramite tasselli ad espansione Ø8 mm. Cavo H05RN-F 2x0,75.

Version with Top retaining ring with two 110° openings. Max. temperature measured on the diffuser 50°C. Complete with fixing kit by means of anchor screws Ø8 mm. Cable type H05RN-F 2x0,75.

Version avec virole Top 2 ouvertures à 110°. Température relevée sur le diffuseur 50° C maxi. Complet de kit de fixation par chevilles à expansion Ø8 mm. Câble H05RN-F 2x0,75.

### CNC 100 C-UP



**DIFF. POLIGLASS**

Fino ad esaurimento.  
Until our stock lasts.  
Jusqu'à épuisement de stock.

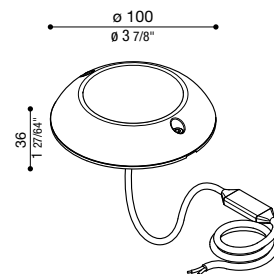

IP68 IK 10 20J xx9 CE UK CA 280 KG MAX 50°C MAX

LED	W	LM	REAL LM	COL.	CODE *	€	* LED COLOUR
4	400	217	220-240 V		LL123025□	169,00	N 4000K
					LL123026□	177,00	3 3000K, Im -5%
					LL123027□	177,00	2 2700K, Im -5%
					LL123028□	177,00	
					LL123029□	177,00	

Emissione luminosa a 120°. Temperatura massima rilevata sul diffusore 50°C. Completo di kit di fissaggio tramite tasselli ad espansione Ø8 mm. Versione calpestabile. Cavo H05RN-F 3x1

Light beam 120°. Max. temperature measured on the diffuser 50°C. Complete with fixing kit by means of anchor screws Ø8 mm. Walk-over version. Cable type H05RN-F 3x1

Angle de diffusion 120°. Température relevée sur le diffuseur 50° C maxi. Complet de kit de fixation par chevilles à expansion Ø8 mm. Version piétinable. Câble H05RN-F 3x1

#### Finishing

Acciaio Inox Elettrolucidato Stainless steel electropolished	Grigio antracite RAL 7021 Grey anthracite RAL 7021 Gris anthracite RAL 7021
Bianco RAL 9010 White RAL 9010 Blanc RAL 9010	Corten Corten Corten
Grigio High Tech RAL 9006 Grey High Tech RAL 9006 Gris High Tech RAL 9006	

#### \* Led colour

- N 4000K
- 3 3000K, Im -5%
- 2 2700K, Im -5%
- B Blue

**Completa il codice** sostituendo al quadrato rosso la lettera o il numero corrispondente alla temperatura colore scelta.

**Complete the code** by replacing the red box with the letter or number corresponding to the selected colour temperature.

**Compléter le code** en remplaçant le carré rouge par la lettre ou le numéro correspondant à la sélection de température couleur.

#### ✓ Alimentatore integrato

Integrated driver  
Alimentation intégrée

#### ✗ Alimentatore escluso

Driver not included  
Alimentation non incluse



# CNC 100

## ACCESSORI

Accessories / Accessoires

### Armatura da incasso CNC100

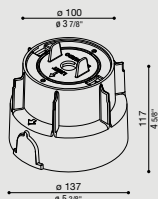

Armatura da incasso in termoplastico.

*Thermoplastic recess box  
CNC100*

*Thermoplastic recess box.*

*Armature à encastrer CNC100*  
*Armature à encastrer en matériau*  
*thermoplastique.*

COL.	CODE	€
	LB1230001	11,50

### Alimentatori CNC 100 in corrente costante

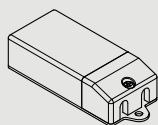

*CNC 100 ballasts*  
*in constant current*

*Alimentations CNC 100*  
*en courant constant*

**700mA**

N° max	IP	CODE	€
1	67	LB1070041	26,50
3/8	67	LB1070059	47,00
1/4 1-10 Push	20	LB1070043	67,50
1/6 DALI	20	LB1070064	88,00

### Cavo H05RN-F 2x0,75



Cavo H05RN-F in Neoprene, sezione 2x0,75. Adatto ad uso esterno.

*Cable type H05RN-F 2x0,75*  
*Cable type H05RN-F in Neoprene,*  
*section 2x0,75. Suitable for outdoor*  
*use.*

*Câble H05RN-F 2x0,75*  
*Câble H05RN-F en Néoprène,*  
*section 2x0,75. Egalement adapté*  
*à l'usage à l'extérieur.*

5 m	10 m	15 m	20 m
CODE	CODE	CODE	CODE
LB1070004	LB1070005	LB1070006	LB1070007
€ 11,00	€ 22,00	€ 33,00	€ 42,00

### Cavo H05RN-F 3x1

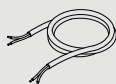

Cavo H05RN-F in Neoprene, sezione 3x1. Adatto ad uso esterno.

*Cable type H05RN-F 3x1*  
*Cable type H05RN-F in Neoprene,*  
*section 3x1. Suitable for outdoor use.*

*Câble H05RN-F 3x1*  
*Câble H05RN-F en Néoprène,*  
*section 3x1. Egalement adapté à*  
*l'usage à l'extérieur.*

5 m	10 m	15 m	20 m
CODE	CODE	CODE	CODE
LB1070054	LB1070055	LB1070056	LB1070057
€ 17,50	€ 31,00	€ 46,00	€ 59,50

**Morsettiere**  
Terminal blocks



**Scaricatori SPD**  
Surge protector devices



Pag. 448



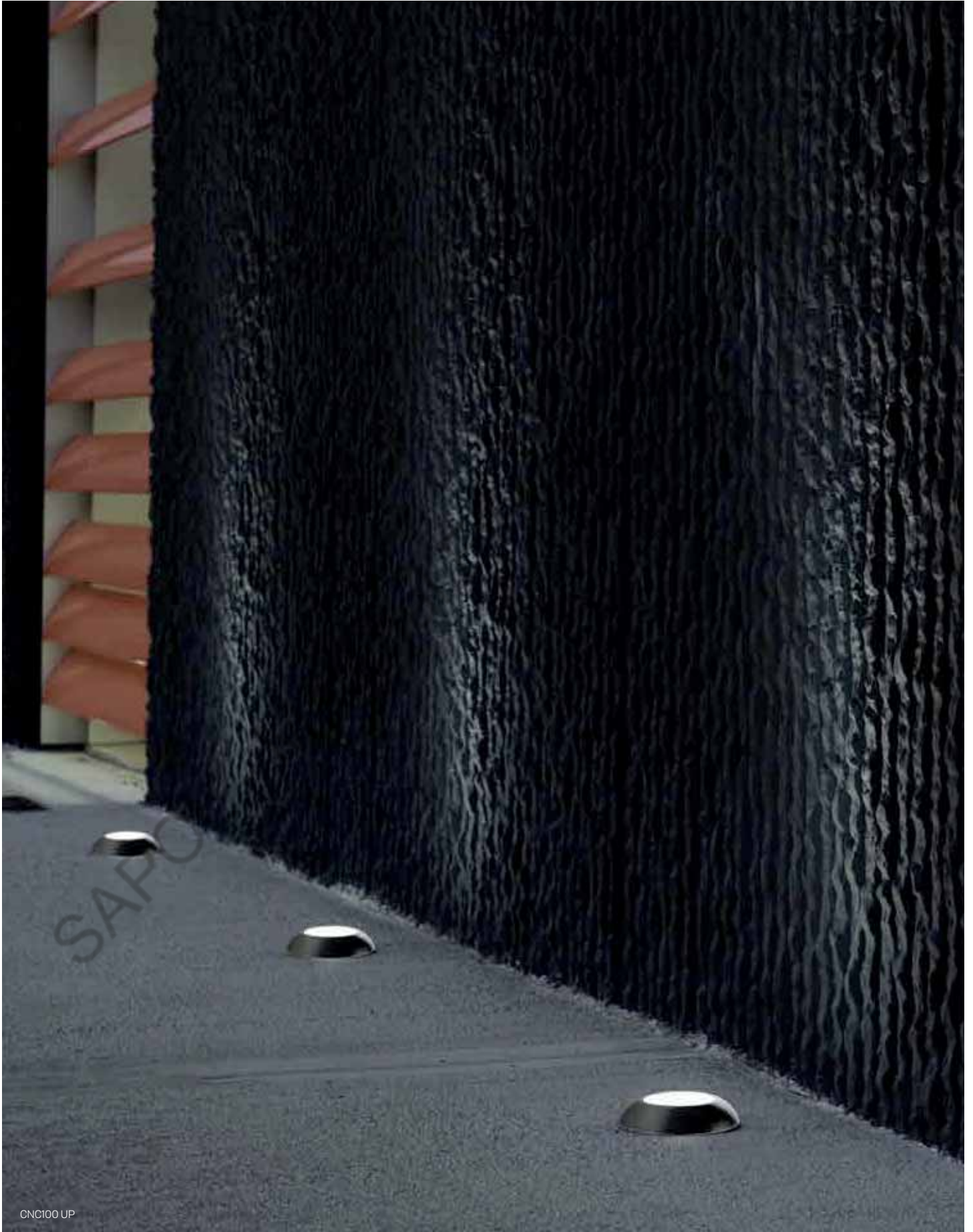

# CNC 120

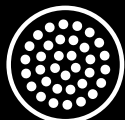

LED

Material Eléctrico e Iluminação



outdoor

**ACCESSORI**

Accessories / Accessoires

Pag. 254



Idoneo per incassi da terra ad uso carrabile.

Idoneo per incassi da terra ad uso calpestabile, fissaggio mediante armatura da incasso fornita a parte. Prodotto finalizzato all'impiego di sorgenti luminose a LED per luce di accento e segnalazione.

Ghiera in acciaio aisi 316L, corpo in alluminio anodizzato EN-6061 T6.

Diffusore in vetro temprato e serigrafato.

Guarnizioni in silicone. 1.5 m di cavo di alimentazione H05RN-F pre-cablato e bloccato tramite pressacavo in Ottone Nichelato.

Bulloneria in acciaio aisi 316L.

Tutti i cavi sono provvisti di una speciale guaina che protegge il faretto dalle infiltrazioni di acqua e umidità.

Versione in tensione costante 12/24V. Versione in corrente costante 700 mA: utilizzare esclusivamente alimentatori di tipo SELV o equivalenti.

**LED 4000K (N), 3000K (3) e 2700K (2) Alimentatore escluso. Nessun rischio fotobiologico, RGO gruppo di rischio esente (EN62471).**

**ENG** Ideal for recessed ground application, also for drive-over use.

Ideal for recessed ground application, also for walk-over use. Installation by means of a recess box supplied separately. Product designed for LED light sources for accent lighting and marking driveways and pathways.

Retaining ring made of stainless steel AISI 316L, body made of EN-6061T6 anodized aluminum.

Heat tempered and silk - screen printed glass. Silicone gaskets. 1.5m pre-wired cable type H05RN-F, secured by means of a nickel-plated brass cable gland.

AISI 316L stainless steel nuts and bolts.

All the wiring is supplied with a special sheathing protecting the spot from seepage of water and damp.

Version in constant tension 12/24V. Version in constant current 700mA: only drivers type SELV or equivalent must be used.

**LED 4000K (N), 3000K (3) or 2700K (2). Ballast not included. No risk of photobiological damage, RGO group (EN62471).**

**FRA** Convient aussi pour une utilisation au sol carrossable.

Convient aussi pour une utilisation au sol piétonnable, fixation par une boîte d'encastrement fournie à part.

Produit finalisé à l'emploi de sources lumineuses à LED pour éclairage d'accentuation et de signalisation.

Collerette en acier inox type AISI 316L et corps en aluminium EN-6061T6 anodisé.

Diffuseur en verre trempé et sérigraphié.

Jointes en silicone. Câble d'alimentation H05RN-F de 1.5m et bloqué par un presse-câble en laiton nickelé.

Vis de fixation en acier inox AISI 316L.

Tous les câbles sont fournis avec une gaine spéciale qui protège le spot des infiltrations d'eau et d'humidité.

Version en tension 12/24V. Version en courant constant 700mA: utiliser exclusivement les drivers du type SELV ou équivalent.

**LED 4000K (N), 3000K (3), 2700K (2). Alimentation exclus. Pas de risque photobiologique, RGO groupe (EN62471).**



**Outdoor  
e waterproof**



**Aquastop**

**CNC 120 T**



**Pre-cablato**  
Pre-wired  
Pré-câblé



**Anni di garanzia  
sul circuito LED**  
Years warranty on LED circuit  
Ans de garantie sur la source LED

# CNC 120

## CNC 120 T



DIFF.  
TRASP.

IP68 IK 10 20J xx9 CE UK CFC 2000<sup>KG</sup> MAX 60<sup>°C</sup> MAX

LED	W	LM	REAL LM		COL.	CODE **	€	* OPTIC	* LED COLOUR
	9	1000	750	⊕ X	700mA - 12V	LL131000□□	195,50	S Spot-25° M 60° A Asymm. D Diff. B Blade	N 4000K 3 3000K, Im -5% 2 2700K, Im -5%
	9	1000	750	⊕ X	12/24V	LL131100□□	207,50		

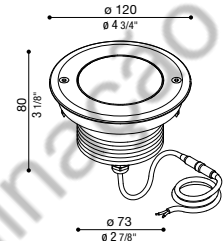

Versione ghiera tonda, possibile scelta di 4 differenti ottiche.  
Temperatura massima rilevata sul vetro 60°C.  
Versione carrabile.

Version with round retaining ring, choice of 4 different optics.  
Max. temperature measured on the glass 60°C.  
Drive-over version.

Version avec collerette ronde, choix possible de 4 optiques différentes.  
Température relevée sur le verre 60°C maxi.  
Version carrossable.

### Armatura da incasso CNC120

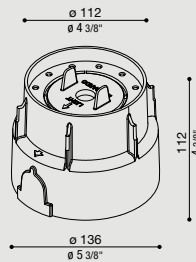

Armatura da incasso in termoplastico.

Thermoplastic recess box  
CNC120  
Thermoplastic recess box.

Armature à encastrer CNC120  
Armature à encastrer en matériau thermoplastique.

COL.	CODE	€
■	LB1310001	11,50

### ACCESSORI

Accessories / Accessoires

### Alimentatori CNC 120 in corrente costante

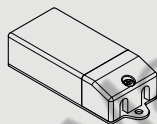

CNC 120 ballasts in constant current

700mA			
N° max	IP	CODE	€
1/2	20	LB1070060	40,50
3/4	20	LB1070061	44,50
1/2	67	LB1070059	47,00

Alimentations CNC 120 en courant constant

N° max	IP	CODE	€
1/2 1-10 Push	20	LB1070043	67,50
1/3 DALI	20	LB1070064	88,00

### Alimentatore CNC 120 in tensione costante 12/24V

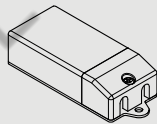

CNC 120 ballasts in constant tension 12/24V

12V			
N° max	IP	CODE	€
1/2	20	LB1070025	34,00
1/3	20	LB1070026	50,00
1/2	67	LB1070027	37,50
1/4	67	LB1070028	50,50

Alimentations CNC 120 en tension 12/24V

24V			
N° max	IP	CODE	€
1/3	20	LB1070029	40,50
1/5	20	LB1070030	50,00
1/4	67	LB1070031	37,50
1/6	67	LB1070032	52,50

### Cavo H05RN-F 2x0,75

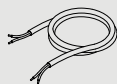

Cavo H05RN-F in Neoprene, sezione 2x0,75. Adatto ad uso esterno.

Cable type H05RN-F 2x0,75  
Cable type H05RN-F in Neoprene, section 2x0,75.  
Suitable for outdoor use.

Câble H05RN-F 2x0,75  
Câble H05RN-F en Néoprène, section 2x0,75.  
Egalement adapté à l'usage à l'extérieur.

5 m	10 m	15 m	20 m
CODE	CODE	CODE	CODE
LB1070004	LB1070005	LB1070006	LB1070007
€ 11,00	€ 22,00	€ 33,00	€ 42,00

### Finishing

■ Inox Spazzolato  
Brushed grey  
Inox brossé

### \* Led colour

- N 4000K
- 3 3000K, Im -5%
- 2 2700K, Im -5%

**Completa il codice**  
sostituendo al quadrato rosso la lettera o il numero corrispondente alla temperatura colore scelta.

**Complete the code**  
by replacing the red box with the letter or number corresponding to the selected colour temperature.

**Compléter le code**  
en remplaçant le carré rouge par la lettre ou le numéro correspondant à la sélection de température couleur.

⊗ **Alimentatore escluso**  
Driver not included  
Alimentation non incluse



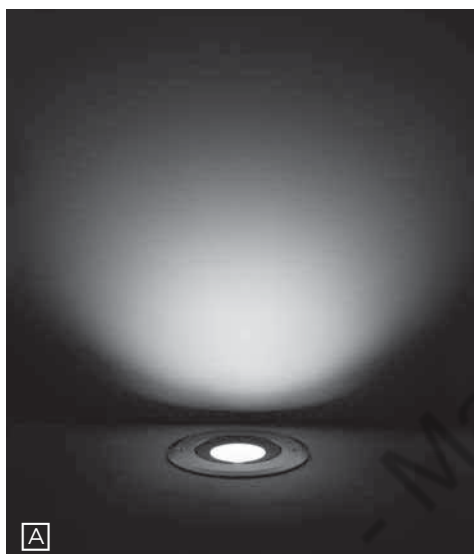
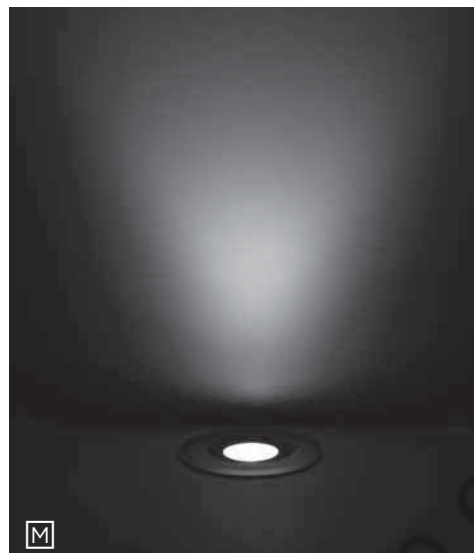

\* **Optic** Completa il codice sostituendo al quadrato grigio la lettera corrispondente al modello di ottica scelta.



*Complete the code by replacing the grey box with the letter corresponding to the selected optic model.*

*Compléter le code en remplaçant le carré gris par la lettre correspondante au modèle de lentille choisie.*



# CNC 120







# CNC 150



LED

Material Eléctrico e Iluminação



outdoor



**ACCESSORI**

Accessories / Accessoires

Pag. 261



Idoneo per incassi da terra ad uso carrabile e calpestabile, fissaggio mediante armatura da incasso fornita a parte. Prodotto finalizzato all'impiego di sorgenti luminose a LED per luce di accento e segnalazione. Ghiera in acciaio aisi 316L, corpo in alluminio anodizzato EN-6061 T6.

Diffusore in vetro temprato.

0.5 m di cavo di alimentazione H05RN-F pre-cablato e bloccato tramite pressacavo in Ottone Nichelato.

Bulloneria in acciaio aisi 316L.

Provvisto di acqua stop integrato che protegge il prodotto dalle infiltrazioni di acqua e umidità.

Versione in corrente costante 600 mA: utilizzare esclusivamente alimentatori di tipo SELV o equivalenti.

**LED 4000K (N), 3000K (3) e 2700K (2) Alimentatore escluso. Nessun rischio fotobiologico, RGO gruppo di rischio esente (EN62471).**

**ENG** Ideal for recessed ground application, both for drive-over and walk-over use Installation by means of a recess box supplied separately. Product designed for LED light sources for accent lighting and making driveways and pathways.

Retaining ring made of stainless steel AISI 316L, body made of anodized aluminium EN-6061 T6.

Tempered glass diffuser.

0.5 m of pre-wired cable type H05RN-F, secured by means of a nickel-plated brass cable gland.

316L stainless steel nuts and bolts.

Product supplied with water-stop device to protect it from water and humidity infiltration.

600 mA constant current version: only drivers type SELV or equivalent must be used.

**LED 4000K (N), 3000K (3) and 2700K (2). Ballast not included. No photobiological risk, RGO risk group (EN62471).**

**FRA** Convient pour une installation au sol piétable, fixation par une boîte d'un d'encastrement fournie à part. Produit finalisé à l'emploi de sources lumineuses LED pour éclairage d'accentuation et de signalisation.

Bague en acier inoxydable AISI 316L, corps en aluminium anodisé EN-6061 T6.

Diffuseur en verre trempé.

Câble d'alimentation H05RN-F de 0,5 m pré-câblé et bloqué par un presse-câble en laiton nickelé.

Fixation en acier inox type AISI 316L.

Dispositif d'arrêt intégré qui protège le produit contre les infiltrations d'eau et d'humidité.

Version en courant constant 600mA : utilisez uniquement des alimentations SELV ou équivalentes.

**LED 4000K (N), 3000K (3) et 2700K (2). Alimentation déportée. Pas de risque photobiologique, RGO groupe (EN62471).**

**Cnc 150**



**Outdoor  
e waterproof**



**Aquastop**





**Pre-cablato**  
Pre-wired  
Pré-câblé



**Anni di garanzia  
sul circuito LED**  
Years warranty on LED circuit  
Ans de garantie sur la source LED

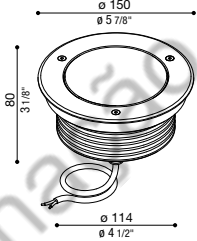

# CNC 150

<b>CNC 150</b>				<b>DIFF. TRASP.</b>																	
<b>IP 67 IK 10 20J xx9</b>		CE UK CA		2000 KG MAX		58°C MAX															
<b>LED</b>	<b>W</b>	<b>LM</b>	<b>REAL LM</b>	<b>COL.</b>	<b>CODE **</b>	<b>€</b>	<b>* OPTIC</b>	<b>* LED COLOUR</b>													
	20	2800	2480	  600mA	LL136000□□	391,50	<table border="0"> <tr><td>S</td><td>12°</td></tr> <tr><td>M</td><td>24°</td></tr> <tr><td>L</td><td>32°</td></tr> </table>	S	12°	M	24°	L	32°	<table border="0"> <tr><td>N</td><td>4000K</td></tr> <tr><td>3</td><td>3000K, Im -5%</td></tr> <tr><td>2</td><td>2700K, Im -5%</td></tr> </table>		N	4000K	3	3000K, Im -5%	2	2700K, Im -5%
S	12°																				
M	24°																				
L	32°																				
N	4000K																				
3	3000K, Im -5%																				
2	2700K, Im -5%																				

Temperatura massima rilevata sul vetro 58°C.

Max. temperature measured on the glass 58°C.

Température relevée sur le verre 58°C maxi.

## Disponibile versione 24V.

Available 24V version.

Disponible en version 24V.



## Finishing

Inox Spazzolato  
Brushed grey  
Inox brossé

## \* Led colour

- N 4000K
- 3 3000K, Im -5%
- 2 2700K, Im -5%

**Completa il codice**  
sostituendo al quadrato rosso la lettera o il numero corrispondente alla temperatura colore scelta.

**Complete the code**  
by replacing the red box with the letter or number corresponding to the selected colour temperature.

**Compléter le code**  
en remplaçant le carré rouge par la lettre ou le numéro correspondant à la sélection de température couleur.

## ⊗ Alimentatore escluso

Driver not included  
Alimentation non incluse



**ACCESSORI**  
Accessories / Accessoires

**Armatura da incasso  
CNC 150**

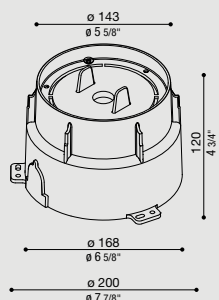

Armatura da incasso in termoplastico.

Thermoplastic recess box.

Armature à encastrer en matériau thermoplastique.

COL.	CODE	€
	<b>LB1360001</b>	<b>17,50</b>

**Cavo H05RN-F  
2x0,75**



Cavo H05RN-F in Neoprene, sezione 2x0,75. Adatto ad uso esterno.

Cable type H05RN-F 2x0,75  
Cable type H05RN-F in Neoprene,  
section 2x0,75. Suitable for outdoor  
use.

Câble H05RN-F 2x0,75  
Câble H05RN-F en Néoprène,  
section 2x0,75. Egalement adapté  
à l'usage à l'extérieur.

5 m	10 m	15 m	20 m
CODE	CODE	CODE	CODE
LB1070004	LB1070005	LB1070006	LB1070007
€ 11,00	€ 22,00	€ 33,00	€ 42,00

**Alimentatori  
CNC 150**

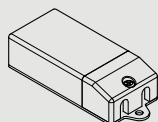

CNC 150 ballasts  
600mA

Alimentations CNC 150

N° max	IP	CODE	€
1	20	<b>LB1070063</b>	<b>40,50</b>
1 DALI	20	<b>LB1070064</b>	<b>88,00</b>

**Morsettiere**  
Terminal blocks



**Scaricatori SPD**  
Surge protector devices



Pag. 448

\* **Optic**



**Completa il codice** sostituendo al quadrato grigio la lettera corrispondente al modello di ottica scelta.

**Complete the code** by replacing the grey box with the letter corresponding to the selected optic model.

**Compléter le code** en remplaçant le carré gris par la lettre correspondante au modèle de lentille choisie.

SAPOL - Materiali Elettrici Illuminazione

# RNC



LED



indoor



outdoor

**ACCESSORI**

Accessories / Accessoires

Pag. 267



Idoneo per incassi da terra ad uso carrabile, fissaggio mediante armatura da incasso fornita a parte. Corpo e diffusore in PMMA. Guarnizioni in silicone. Predisposto per singolo ingresso alimentazione. 1m di cavo di alimentazione H05RN-F pre-cablato e bloccato tramite pressacavo in ottone Nichelato. Prodotto provvisto di molle per fissaggio e acqua-stop integrato che protegge dalle infiltrazioni di acqua e umidità.

**LED 24V. Nessun rischio fotobiologico, RGO gruppo di rischio esente (EN62471). LED 4000K (N), 3000K (3) o 2700K (2). Alimentatore escluso.**

**ENG** Ideal for recessed ground application, also for drive-over use. Installation by means of a recess box supplied separately. PMMA body and diffuser. Silicone gaskets. Single cable entry at the back. 1m of H05RN-F power supply cable pre-wired and secured by means of a nickel-plated brass cable gland. Product supplied with fixing springs and water-stop device to protect it from water and humidity infiltration.

**LED 24V. No photobiological risk, RGO risk group (EN62471). LED 4000K (N), 3000K (3) or 2700K (2). Ballast not included.**

**FRA** Adapté à une installation encastrée dans le sol pour une utilisation sur véhicule, fixation au moyen d'une boîte encastrée fournie séparément. Corps et diffuseur en PMMA. Joints en silicone. Prévu pour une entrée d'alimentation unique. Câble d'alimentation électrique de 1m H05RN-F pré-câblé et verrouillé au moyen d'un presse-étoupe en laiton nickelé. Produit équipé de ressorts de fixation et d'un dispositif d'arrêt de l'eau intégré qui protège contre les infiltrations d'eau et d'humidité.

**LED 24V. Pas de risque photobiologique, groupe de risque RGO exempt (EN62471). LED 4000K (N), 3000K (3) ou 2700K (2). Alimentation électrique exclue.**

**RNC 270**

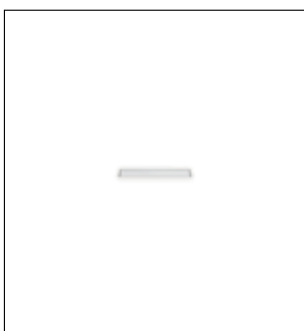

**RNC 520**



**RNC 770**

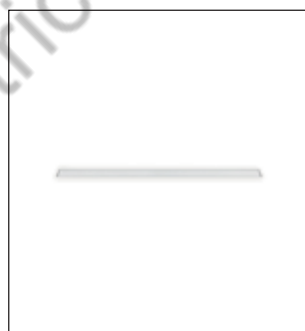

**RNC 1020**

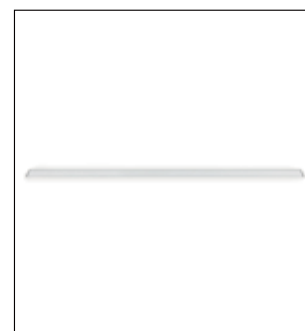

**RNC 2020**

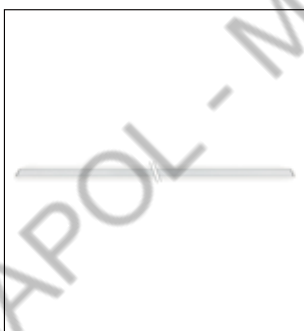

**RNC Slim 270**

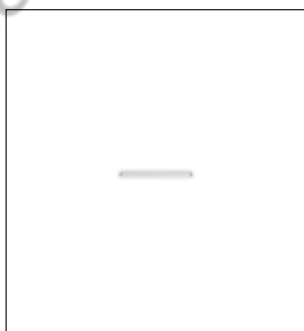

**RNC Slim 520**

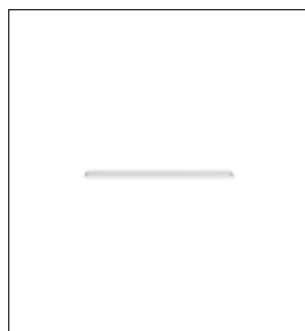

**RNC Slim 770**



**RNC Slim 1020**

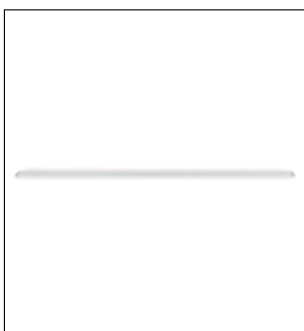

**RNC Slim 2020**

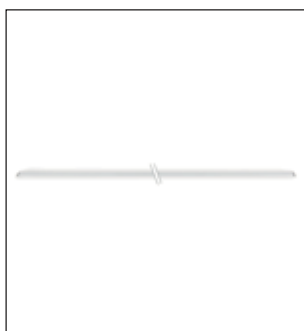

**Outdoor e waterproof**



**Anni di garanzia sul circuito LED**

Years warranty on LED circuit  
Ans de garantie sur la source LED



**Aquastop**



# RNC

<b>RNC 270</b>				<b>DIFF. OPAL.</b>		
<b>IP 67 IK 10 20J xx9</b>						
<b>LED</b>	<b>W</b>	<b>LM</b>	<b>REAL LM</b>	<b>COL.</b>	<b>CODE *</b>	
	2,5	300	75	24V	<b>LL138000</b>	<b>232,50</b> 4000K 3000K, lm -5% 2700K, lm -5%

Temperatura massima rilevata sul diffusore 35°C.

Max. temperature measured on the diffuser 35°C.

Température relevée sur le diffuseur 35° C maxi.

<b>RNC 520</b>				<b>DIFF. OPAL.</b>		
<b>IP 67 IK 10 20J xx9</b>						
<b>LED</b>	<b>W</b>	<b>LM</b>	<b>REAL LM</b>	<b>COL.</b>	<b>CODE *</b>	
	5	600	155	24V	<b>LL138001</b>	<b>286,50</b> 4000K 3000K, lm -5% 2700K, lm -5%

Temperatura massima rilevata sul diffusore 35°C.

Max. temperature measured on the diffuser 35°C.

Température relevée sur le diffuseur 35° C maxi.

<b>RNC 770</b>				<b>DIFF. OPAL.</b>		
<b>IP 67 IK 10 20J xx9</b>						
<b>LED</b>	<b>W</b>	<b>LM</b>	<b>REAL LM</b>	<b>COL.</b>	<b>CODE *</b>	
	7,5	900	220	24V	<b>LL138002</b>	<b>391,50</b> 4000K 3000K, lm -5% 2700K, lm -5%

Temperatura massima rilevata sul diffusore 35°C.

Max. temperature measured on the diffuser 35°C.

Température relevée sur le diffuseur 35° C maxi.

<b>RNC 1020</b>				<b>DIFF. OPAL.</b>		
<b>IP 67 IK 10 20J xx9</b>						
<b>LED</b>	<b>W</b>	<b>LM</b>	<b>REAL LM</b>	<b>COL.</b>	<b>CODE *</b>	
	10	1200	300	24V	<b>LL138003</b>	<b>442,00</b> 4000K 3000K, lm -5% 2700K, lm -5%







Temperatura massima rilevata sul vetro 35°C.

Max. temperature measured on the glass 35°C.

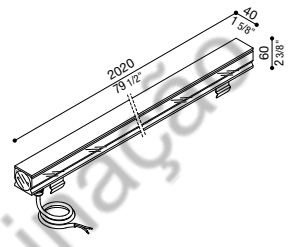
Température relevée sur le verre 35° C maxi.









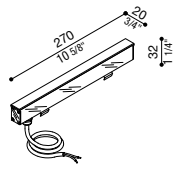

<b>RNC 2020</b>				DIFF. OPAL.			
IP67 IK 10 20J xx9    2000 <sup>KG</sup> <sub>MAX</sub>  35° <sup>MAX</sup>							
LED	W	LM	REAL LM	COL.	CODE *	€	* LED COLOUR
	20	2400	590	 24V	 LL138004□	831,00	N 4000K 3 3000K, lm -5% 2 2700K, lm -5%

Temperatura massima rilevata sul diffusore 35°C.

Max. temperature measured on the diffuser 35°C.







Température relevée sur le diffuseur 35° C maxi.

<b>RNC Slim 270</b>				DIFF. OPAL.			
IP67 IK 10 20J xx9    2000 <sup>KG</sup> <sub>MAX</sub>  35° <sup>MAX</sup>							
LED	W	LM	REAL LM	COL.	CODE *	€	* LED COLOUR
	2,5	300	65	 24V	 LL138100□	177,00	N 4000K 3 3000K, lm -5% 2 2700K, lm -5%

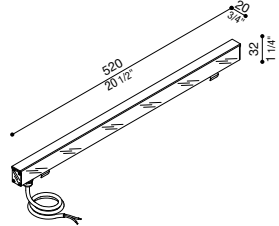
Temperatura massima rilevata sul diffusore 35°C.

Max. temperature measured on the diffuser 35°C.







Température relevée sur le diffuseur 35° C maxi.

<b>RNC Slim 520</b>				DIFF. OPAL.			
IP67 IK 10 20J xx9    2000 <sup>KG</sup> <sub>MAX</sub>  35° <sup>MAX</sup>							
LED	W	LM	REAL LM	COL.	CODE *	€	* LED COLOUR
	5	600	125	 24V	 LL138101□	218,50	N 4000K 3 3000K, lm -5% 2 2700K, lm -5%

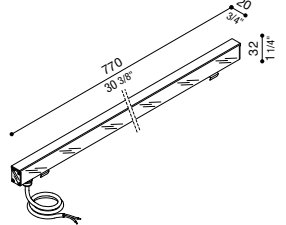
Temperatura massima rilevata sul diffusore 35°C.

Max. temperature measured on the diffuser 35°C.

Température relevée sur le diffuseur 35° C maxi.



<b>RNC Slim 770</b>				DIFF. OPAL.			
IP67 IK 10 20J xx9    2000 <sup>KG</sup> <sub>MAX</sub>  35° <sup>MAX</sup>							
LED	W	LM	REAL LM	COL.	CODE *	€	* LED COLOUR
	7,5	900	200	 24V	 LL138102□	301,50	N 4000K 3 3000K, lm -5% 2 2700K, lm -5%

Temperatura massima rilevata sul diffusore 35°C.

Max. temperature measured on the diffuser 35°C.

Température relevée sur le diffuseur 35° C maxi.

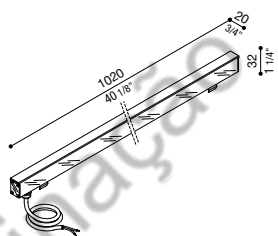

# RNC

<b>RNC Slim 1020</b>				DIFF. OPAL.		
IP67 IK 10 20J xx9						
LED	W	LM	REAL LM	COL.	CODE *	€ * LED COLOUR
	10	1200	280		 <b>LL138103</b>	<b>333,00</b> <ul style="list-style-type: none"> <li>N 4000K</li> <li>S 3000K, lm -5%</li> <li>2 2700K, lm -5%</li> </ul>

Temperatura massima rilevata sul diffusore 35°C.

Max. temperature measured on the diffuser 35°C.

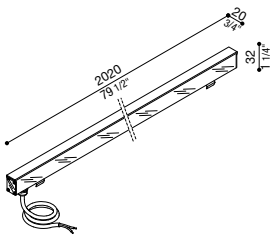
Température relevée sur le diffuseur 35° C maxi.

<b>RNC Slim 2020</b>				DIFF. OPAL.		
IP67 IK 10 20J xx9						
LED	W	LM	REAL LM	COL.	CODE *	€ * LED COLOUR
	20	2400	550		 <b>LL138104</b>	<b>676,00</b> <ul style="list-style-type: none"> <li>N 4000K</li> <li>S 3000K, lm -5%</li> <li>2 2700K, lm -5%</li> </ul>

Temperatura massima rilevata sul diffusore 35°C.

Max. temperature measured on the diffuser 35°C.

Température relevée sur le diffuseur 35° C maxi.





**ACCESSORI**

Accessories / Accessoires

**Armatura da incasso RNC 270**

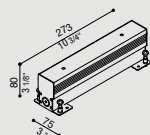

Armatura da incasso in alluminio.

*Recess box RNC 270  
Aluminium recessed box.*

*Armature à encastrer RNC 270  
Armature à encastrer en aluminium.*

COL.	CODE	€
	<b>LB1380001</b>	<b>27,00</b>

**Armatura da incasso RNC 520**

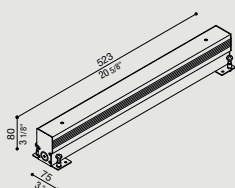

Armatura da incasso in alluminio.

*Recess box RNC 520  
Aluminium recessed box.*

*Armature à encastrer RNC 520  
Armature à encastrer en aluminium.*

COL.	CODE	€
	<b>LB1380002</b>	<b>35,50</b>

**Armatura da incasso RNC 770**

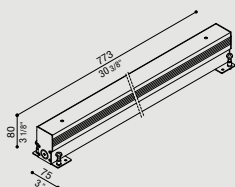

Armatura da incasso in alluminio.

*Recess box RNC 770  
Aluminium recessed box.*

*Armature à encastrer RNC 770  
Armature à encastrer en aluminium.*

COL.	CODE	€
	<b>LB1380003</b>	<b>44,50</b>

**Armatura da incasso RNC 1020**

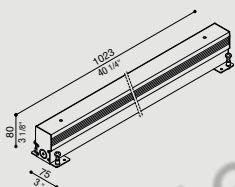

Armatura da incasso in alluminio.

*Recess box RNC 1020  
Aluminium recessed box.*

*Armature à encastrer RNC 1020  
Armature à encastrer en aluminium.*

COL.	CODE	€
	<b>LB1380004</b>	<b>54,00</b>

**Armatura da incasso RNC 2020**

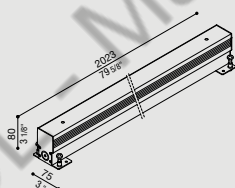

Armatura da incasso in alluminio.

*Recess box RNC 2020  
Aluminium recessed box.*

*Armature à encastrer RNC 2020  
Armature à encastrer en aluminium.*

COL.	CODE	€
	<b>LB1380009</b>	<b>89,50</b>

**Armatura da incasso RNC Slim 270**

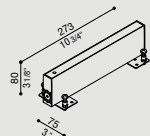

Armatura da incasso in alluminio.

*Recess box RNC Slim 270  
Aluminium recessed box.*

*Armature à encastrer RNC Slim 270  
Armature à encastrer en aluminium.*

COL.	CODE	€
	<b>LB1380005</b>	<b>17,50</b>

**Armatura da incasso RNC Slim 520**

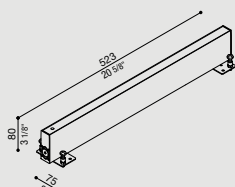

Armatura da incasso in alluminio.

*Recess box RNC Slim 520  
Aluminium recessed box.*

*Armature à encastrer RNC Slim 520  
Armature à encastrer en aluminium.*

COL.	CODE	€
	<b>LB1380006</b>	<b>24,50</b>

# RNC

## ACCESSORI

Accessories / Accessoires

### Armatura da incasso RNC Slim 770

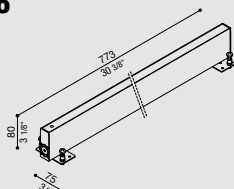

Armatura da incasso in alluminio.

*Recess box RNC Slim 770  
Aluminium recessed box.*

*Armature à encastrer RNC  
Slim 770  
Armature à encastrer en  
aluminium.*

COL.	CODE	€
	<b>LB1380007</b>	<b>30,50</b>

### Armatura da incasso RNC Slim 1020

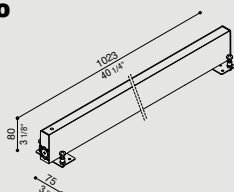

Armatura da incasso in alluminio.

*Recess box RNC Slim 1020  
Aluminium recessed box.*

*Armature à encastrer RNC  
Slim 1020  
Armature à encastrer en  
aluminium.*

COL.	CODE	€
	<b>LB1380008</b>	<b>37,50</b>

### Armatura da incasso RNC Slim 2020

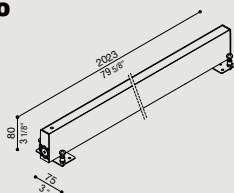

Armatura da incasso in alluminio.

*Recess box RNC Slim 2020  
Aluminium recessed box.*

*Armature à encastrer RNC  
Slim 2020  
Armature à encastrer en  
aluminium.*

COL.	CODE	€
	<b>LB1380010</b>	<b>67,50</b>

### Chiavi di rimozione RNC



Chiavi per rimozione apparecchio.

*Keys for device removal.*

*Clés pour retirer l'appareil.*

COL.	CODE	€
	<b>LB1380000</b>	<b>23,50</b>

### Alimentatore RNC in tensione costante 24V

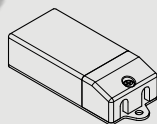

*RNC ballasts in constant  
tension 24V*

*Alimentations RNC  
en tension 24V*

#### RNC 520 / RNC Slim 520

N° max	IP	CODE	€
1/4	20	<b>LB1070029</b>	<b>40,50</b>
1/7	20	<b>LB1070030</b>	<b>50,00</b>
1/4	67	<b>LB1070031</b>	<b>37,50</b>
1/8	67	<b>LB1070032</b>	<b>52,50</b>
1/3 DALI	20	<b>LB1070065</b>	<b>103,00</b>

#### RNC1020 / RNC Slim1020

N° max	IP	CODE	€
1/2	20	<b>LB1070030</b>	<b>50,00</b>
1/4	67	<b>LB1070032</b>	<b>52,50</b>
1 DALI	20	<b>LB1070065</b>	<b>103,00</b>

#### RNC 270 / RNC Slim 270

N° max	IP	CODE	€
1/8	20	<b>LB1070029</b>	<b>40,50</b>
1/12	20	<b>LB1070030</b>	<b>50,00</b>
1/8	67	<b>LB1070031</b>	<b>37,50</b>
1/16	67	<b>LB1070032</b>	<b>52,50</b>
1/6 DALI	20	<b>LB1070065</b>	<b>103,00</b>

#### RNC 770 / RNC Slim 770

N° max	IP	CODE	€
1/2	20	<b>LB1070029</b>	<b>40,50</b>
1/4	20	<b>LB1070030</b>	<b>50,00</b>
1/2	67	<b>LB1070031</b>	<b>37,50</b>
1/5	67	<b>LB1070032</b>	<b>52,50</b>
1/2 DALI	20	<b>LB1070065</b>	<b>103,00</b>

#### RNC2020 / RNC Slim 2020

N° max	IP	CODE	€
1	20	<b>LB1070030</b>	<b>50,00</b>
1/2	67	<b>LB1070032</b>	<b>52,50</b>



Rimozione RNC con apposite chiavi (non incluse).

Remove RNC with special keys (not included).

Enlèvement du RNC avec des clés spéciales (non incluses).



RNC



RNC Slim



# RNC

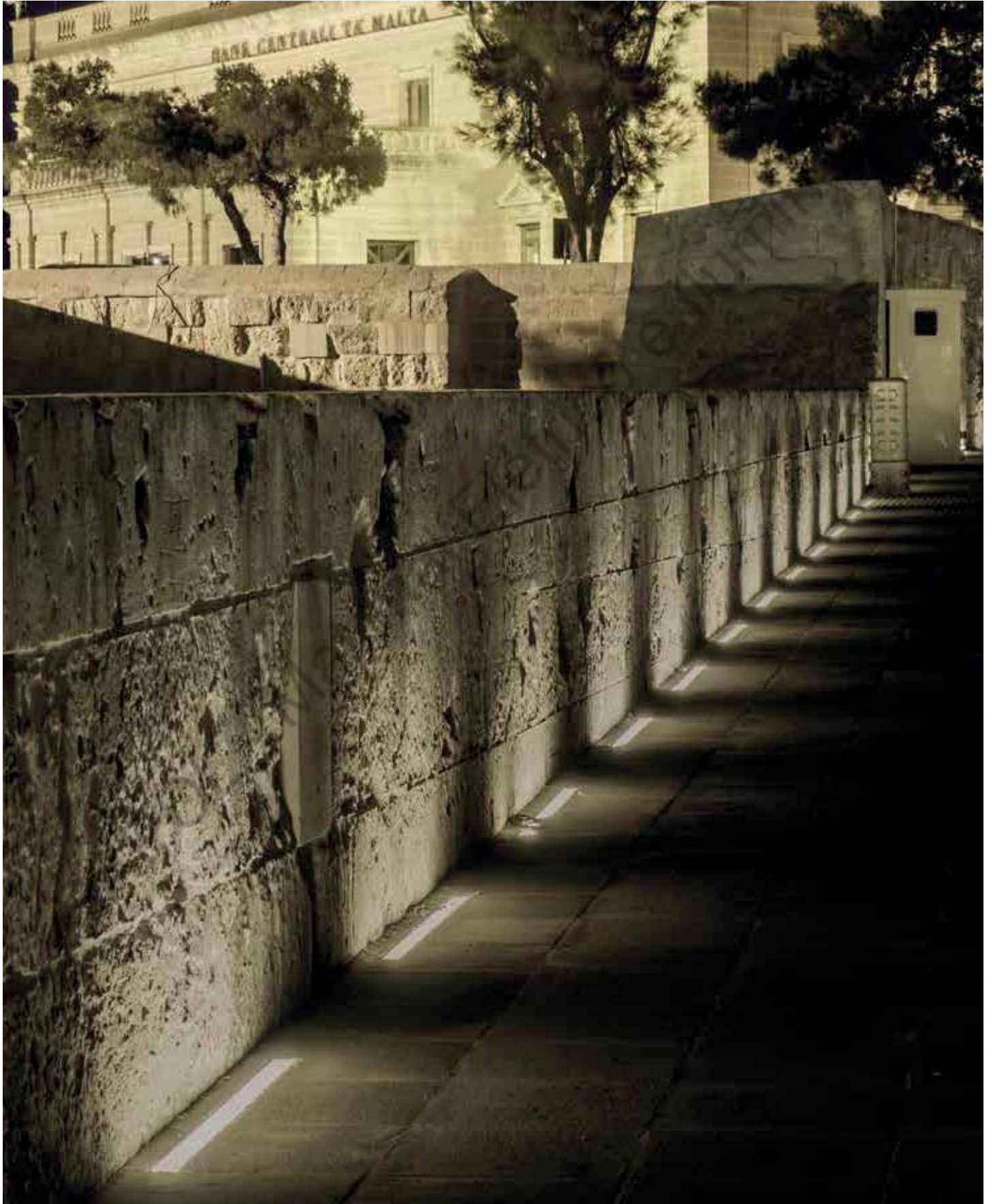





# TNC



LED



OL - Material Eléctrico e Iluminação



outdoor

**ACCESSORI**

Accessories / Accessoires

Pag. 275



Apparecchio lineare da esterni per installazione a soffitto e parete.

Riflettore interno in alluminio estruso, tappi laterali in alluminio anodizzato, diffusore in PMMA opale e corpo in Policarbonato. Predisposto per singolo ingresso alimentazione. Apparecchio inaccessibile fornito con 1m di cavo H05RN-F precablato. Acqua-stop integrato che protegge il prodotto dalle infiltrazioni di acqua e umidità.

**LED 24V. Nessun rischio fotobiologico, RG0 gruppo di rischio esente (EN62471). LED 4000K (N), 3000K (3) o 2700K (2). Alimentatore escluso.**

**ENG** Outdoor linear fixture suitable for ceiling and wall installation. Extruded aluminium inner reflector, anodized aluminium side caps, opal PMMA diffuser and Polycarbonate body.

Single cable entry at the back. Inaccessible device supplied with 1m of pre-wired H05RN-F cable. Water-stop device included to protect the product from water and humidity infiltration.

**LED 24V. No photobiological risk, RG0 risk group (EN62471). LED 4000K (N), 3000K (3) or 2700K (2). Ballast not included.**

**FRA** Dispositif linéaire pour l'extérieur, à installer au plafond et au mur.

Réflecteur intérieur en aluminium extrudé, couvercles latérales en aluminium anodisé, diffuseur en PMMA opale et corps en polycarbonate. Predisposé pour une seule entrée d'alimentation électrique. Luminaire inaccessible fourni avec 1m de câble d'alimentation H05RN-F pré-câblé. Dispositif d'arrêt intégré qui protège le produit contre les infiltrations d'eau et d'humidité.

**LED 24V. Pas de risque photobiologique, groupe de risque RG0 exempt (EN62471). LED 4000K (N), 3000K (3) ou 2700K (2). Alimentation électrique exclue.**

**TNC 305**

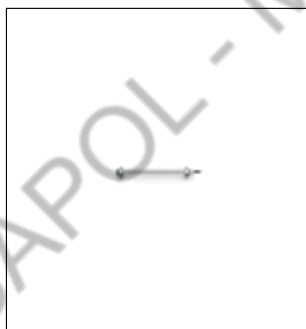

**TNC 555**



**TNC 1055**



**Outdoor  
e waterproof**



**Aquastop**



**Pre-cablato**  
Pre-wired  
Pré-câblé







**Dimmerabile**  
Dimmable  
Dimmable



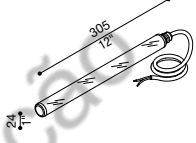

**Anni di garanzia  
sul circuito LED**  
Years warranty on LED circuit  
Ans de garantie sur la source LED

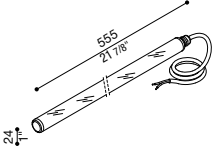
# TNC

<b>TNC 305</b>				<b>DIFF. TRASP.</b>									
													
<b>IP 67 IK 09 10J xx7 CE UK CRA</b>													
LED	W	LM	REAL LM	COL.	CODE *	€	* LED COLOUR						
	5	550	366	 24V	 LL139100□	139,50	<table border="1"> <tr><td>N</td><td>4000K</td></tr> <tr><td>3</td><td>3000K, lm -5%</td></tr> <tr><td>2</td><td>2700K, lm -5%</td></tr> </table>	N	4000K	3	3000K, lm -5%	2	2700K, lm -5%
N	4000K												
3	3000K, lm -5%												
2	2700K, lm -5%												

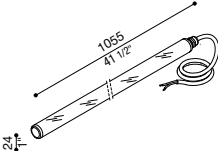
<b>TNC 555</b>				<b>DIFF. TRASP.</b>									
													
<b>IP 67 IK 09 10J xx7 CE UK CRA</b>													
LED	W	LM	REAL LM	COL.	CODE *	€	* LED COLOUR						
	10	1100	666	 24V	 LL139200□	185,50	<table border="1"> <tr><td>N</td><td>4000K</td></tr> <tr><td>3</td><td>3000K, lm -5%</td></tr> <tr><td>2</td><td>2700K, lm -5%</td></tr> </table>	N	4000K	3	3000K, lm -5%	2	2700K, lm -5%
N	4000K												
3	3000K, lm -5%												
2	2700K, lm -5%												

<b>TNC 1055</b>				<b>DIFF. TRASP.</b>									
													
<b>IP 67 IK 09 10J xx7 CE UK CRA</b>													
LED	W	LM	REAL LM	COL.	CODE *	€	* LED COLOUR						
	20	2200	1266	 24V	 LL139300□	232,50	<table border="1"> <tr><td>N</td><td>4000K</td></tr> <tr><td>3</td><td>3000K, lm -5%</td></tr> <tr><td>2</td><td>2700K, lm -5%</td></tr> </table>	N	4000K	3	3000K, lm -5%	2	2700K, lm -5%
N	4000K												
3	3000K, lm -5%												
2	2700K, lm -5%												

**\* Led colour**

- N 4000K
- 3 3000K, lm -5%
- 2 2700K, lm -5%

**Completa il codice**

sostituendo al quadrato rosso la lettera o il numero corrispondente alla temperatura colore scelta.

**Complete the code**

by replacing the red box with the letter or number corresponding to the selected colour temperature.

**Compléter le code**

en remplaçant le carré rouge par la lettre ou le numéro correspondant à la sélection de température couleur.

**⊗ Alimentatore escluso**  
Driver not included  
Alimentation non incluse





**ACCESSORI**  
Accessories / Accessoires

**Clip di fissaggio TNC**

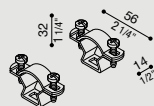

Clip di fissaggio TNC

*TNC fixing clips*  
TNC fixing clips

*Clips de fixation TNC*  
Clips de fixation TNC

COL.	CODE	€
	<b>LB1390001</b>	<b>4,30</b>

**Braccetto TNC**

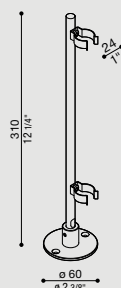

Braccetto per installazione perpendicolare alla superficie (giardino, suolo o parete) del modello TNC. Fornito con accessorio da giardino. Adatto anche per uso esterno.

*TNC bracket*  
TNC bracket for perpendicular installation to the surface (garden, ground or wall). Supplied with removable garden accessory. Also suitable for outdoor use.

*Bras TNC*  
Support TNC pour une installation perpendiculaire à la surface (jardin, sol ou mur). Fourni avec un accessoire de jardin amovible. Convient également pour une utilisation en extérieur.

COL.	CODE	€
	<b>LB1390004</b>	<b>51,00</b>

**Picchetti TNC**

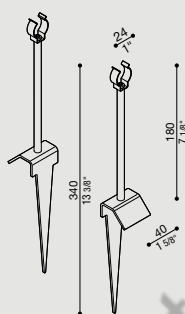

Coppia di picchetti da giardino in acciaio AISI 316L forniti con coppia di distanziali in alluminio tornito con anodizzazione naturale. Da abbinare ai modelli TNC. Adatto per uso esterno, idoneo per installazione a terra.

*Garden accessories for TNC*  
Pair of AISI 316L steel garden accessories supplied with a pair of turned aluminium spacers with natural anodization. To be combined with TNC models. Suitable for outdoor use and for ground installation.

*Accessoires de jardin pour TNC*  
Paire d'accessoires de jardin en acier AISI 316L fournis avec une paire d'entretoises en aluminium tourné avec anodisation naturelle. A combiner avec les modèles TNC. Convient pour une utilisation en extérieur et au sol.

COL.	CODE	€
	<b>LB1390002</b>	<b>51,00</b>

**Distanziali TNC**

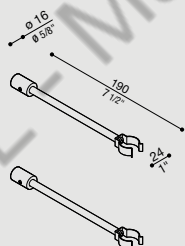

Accessorio per installazione a terra e a parete del modello TNC.

*TNC accessory*  
TNC accessory for floor and wall installation.

*Accessoire TNC*  
Accessoire TNC pour l'installation au sol et au mur.

COL.	CODE	€
	<b>LB1390003</b>	<b>40,50</b>

**Alimentatore TNC in tensione costante 24V**

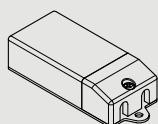

*TNC ballasts in constant tension 24V*

*Alimentations TNC en tension 24V*

**TNC 305**

N° max	IP	CODE	€
1/5	20	<b>LB1070029</b>	<b>40,50</b>
1/8	20	<b>LB1070030</b>	<b>50,00</b>
1/5	67	<b>LB1070031</b>	<b>37,50</b>
1/10	67	<b>LB1070032</b>	<b>52,50</b>
1/4 DALI	20	<b>LB1070065</b>	<b>103,00</b>

**TNC 555**

N° max	IP	CODE	€
1/2	20	<b>LB1070029</b>	<b>40,50</b>
1/4	20	<b>LB1070030</b>	<b>50,00</b>
1/2	67	<b>LB1070031</b>	<b>37,50</b>
1/5	67	<b>LB1070032</b>	<b>52,50</b>
1/2 DALI	20	<b>LB1070065</b>	<b>103,00</b>

**TNC 1055**

N° max	IP	CODE	€
1/2	20	<b>LB1070030</b>	<b>50,00</b>
1/2	67	<b>LB1070032</b>	<b>52,50</b>
1 DALI	20	<b>LB1070065</b>	<b>103,00</b>

# TNC



Montaggio TNC con apposite clip (non incluse).

TNC mounting with fixing clips (not included).

Fixation du TNC avec des clips appropriés (non inclus).

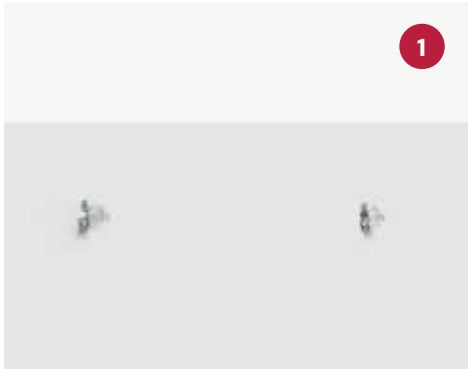





# TNC

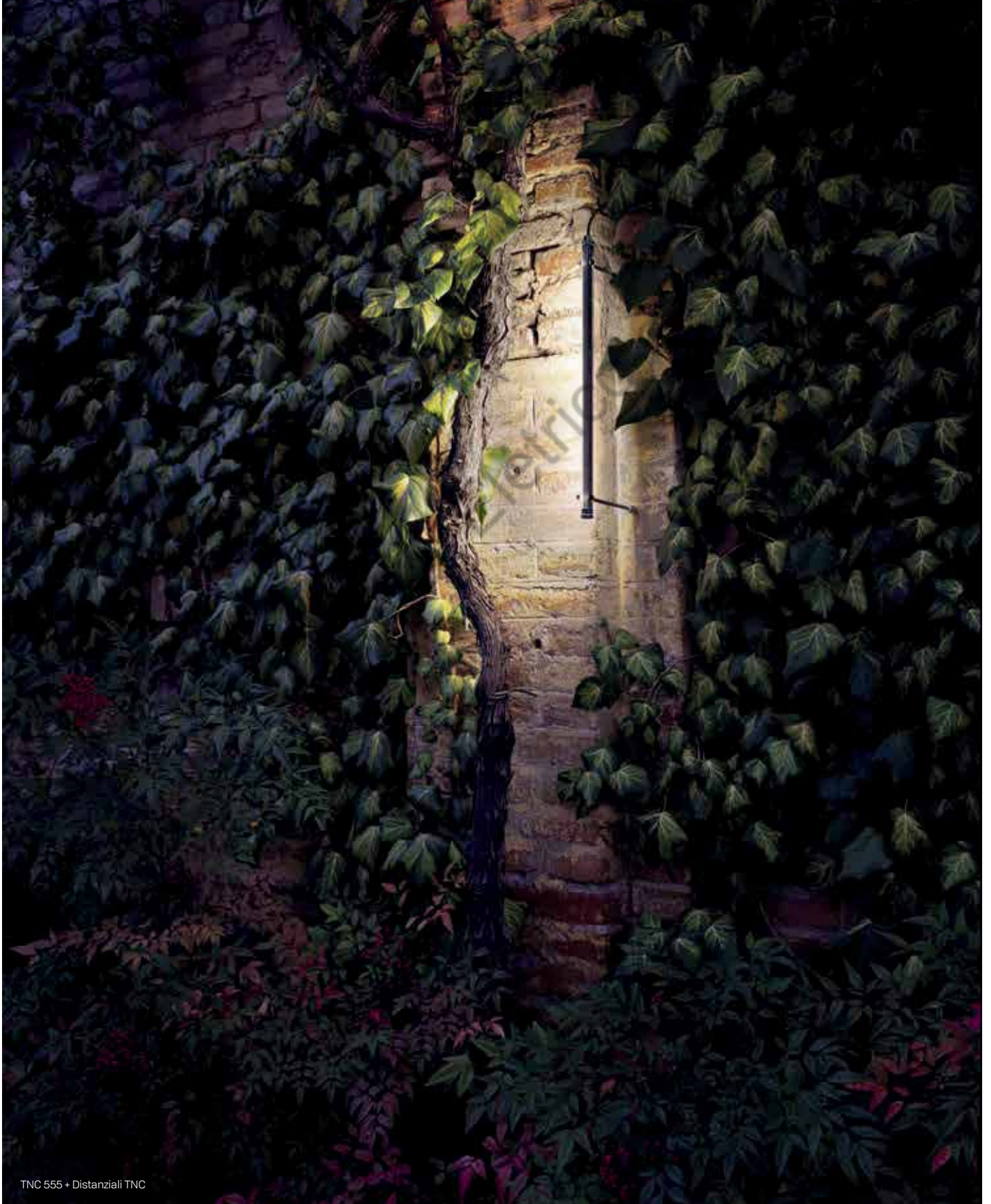



TNC 1055 + Braccetto TNC



TNC 305 + Picchetti TNC



# Pop

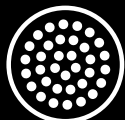

LED



indoor



outdoor

**ACCESSORI**

Accessories / Accessoires

Pag. 287



Adatto per installazioni in controsoffittature di cartongesso ad uso interno ed esterno. Corpo in policarbonato. Dissipatore in alluminio primario pressofuso EN-AB44100. Diffusore in policarbonato trasparente tampografato. Installazione ad incasso tramite molle. Alimentatore esterno al prodotto. Fornito con 0,25m di cavo H03VVH2-F. Dimmerazione disponibile. Fornito con adattatore extra per coprire incassi di dimensioni maggiori. Bulloneria in acciaio inox A4 o AISI 316L.

Codici LL: forniti con alimentatore esterno al prodotto. Alimentazione diretta 220-240V.

Codici LZ: alimentazione esclusa.

**LED 4000K (N), 3000K (3) e 2700K (2). Nessun rischio fotobiologico, RGO gruppo di rischio esente (EN62471).**

**ENG** Suitable for installation in plasterboard ceilings for indoor and outdoor use. Polycarbonate body.

Die-cast primary aluminium heat sink EN-AB44100.

Transparent polycarbonate diffuser.

Recessed installation by means of springs.

External power supply. Supplied with 0,25m H03VVH2-F cable.

Dimming available.

Supplied with extra adapter to cover larger recesses.

A4 or AISI 316L stainless steel hardware.

LL codes: supplied with external driver. Direct power supply 220-240V.

LZ codes: power supply excluded.

**4000K (N), 3000K (3) and 2700K (2) LED.**

No photobiological risk, RGO risk group exempt (EN62471).

**FRA** Convient pour une installation dans les plafonds en plaques de plâtre pour une utilisation intérieure et extérieure.

Corps en polycarbonate. Dissipateur thermique en aluminium primaire moulé sous pression EN-AB44100. Diffuseur en polycarbonate transparent. Installation encastrée au moyen de ressorts.

Alimentation externe. Fourni avec un câble H03VVH2-F de 0,25 m.

Gradation disponible. Fourni avec un adaptateur supplémentaire pour couvrir de plus grandes cavités. Boulons en acier inoxydable A4 ou AISI 316L.

Codes LL : fournis avec une unité d'alimentation externe. Alimentation électrique directe 220-240V.

Codes LZ : alimentation exclue.

**LED 4000K (N), 3000K (3) et 2700K (2).**

Pas de risque photobiologique, RGO groupe (EN62471).

**Pop 60 T**



**Pop 60 Q**



**Pop 80 T**



**Pop 80 T Asimmetrico**



**Pop 80 Q**



**Pop 80 Q Asimmetrico**



**Pop 100 T**



**Outdoor e waterproof**



**Pre-cablato**  
Pre-wired  
Pré-câblé



**Anni di garanzia sul circuito LED**  
Years warranty on LED circuit  
Ans de garantie sur la source LED

# Pop

Colori disponibili.  
Available colours.  
Couleurs disponibles.



1





2

# Pop

## Pop 60 T

NEW

DIFF. TRASP.

IP65 IK 07 2J xx5 CE UK CA

LED	W	LM	REAL LM	COL.	CODE **	€	* OPTIC	* LED COLOUR
7	1000	800	220-240 V		LL14600W□□	58,00	S 25°	N 4000K
					LL14600B□□	68,00	M 45°	3 3000K, Im -5%
					LL14600Z□□	68,00	D Diff.	2 2700K, Im -5%
					LL14600U□□	68,00		
					LL14600G□□	68,00		
7	1000	800	500mA - 14V		LZ14600A□□	68,00		
					LZ14600W□□	48,00		
					LZ14600B□□	58,00		
					LZ14600Z□□	58,00		
					LZ14600U□□	58,00		
	LZ14600G□□	58,00						
	LZ14600A□□	58,00						

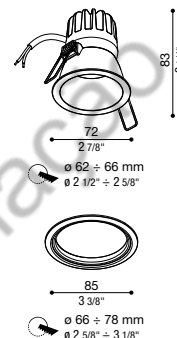

Codici LL14600A e LZ14600A in versione All Black con vetro serigrafato nero e anello adattatore nero.

Codes LL14600A and LZ14600A in All Black version with black serigraphed glass and black adapter ring.

Codes LL14600A et LZ14600A en version All Black avec verre sérigraphié noir et bague d'adaptation noire.

## Pop 60 Q

NEW

DIFF. TRASP.

IP65 IK 07 2J xx5 CE UK CA

LED	W	LM	REAL LM	COL.	CODE **	€	* OPTIC	* LED COLOUR
7	1000	840	220-240 V		LL14601W□□	58,00	S 25°	N 4000K
					LL14601B□□	68,00	M 45°	3 3000K, Im -5%
					LL14601Z□□	68,00	D Diff.	2 2700K, Im -5%
					LL14601U□□	68,00		
					LL14601G□□	68,00		
7	1000	840	500mA		LZ14601A□□	68,00		
					LZ14601W□□	48,00		
					LZ14601B□□	58,00		
					LZ14601Z□□	58,00		
					LZ14601U□□	58,00		
	LZ14601G□□	58,00						
	LZ14601A□□	58,00						

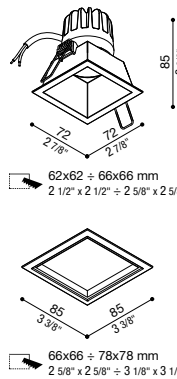

Codici LL14601A e LZ14601A in versione All Black con vetro serigrafato nero e anello adattatore nero.

Codes LL14601A and LZ14601A in All Black version with black serigraphed glass and black adapter ring.

Codes LL14601A et LZ14601A en version All Black avec verre sérigraphié noir et bague d'adaptation noire.

### Finishing

	Bianco da stampaggio White Blanc moulé		Bianco - Rame White - Copper Blanc - Cuivre
	Bianco - Nero verniciato White - Black painted Blanc - Noir peint		Bianco - Silver White - Silver Blanc - Silver
	Bianco - Gold White - Gold Blanc - Gold		All Black All Black All Black

### ✓ Alimentatore incluso da remoto

Remote driver included  
Alimentation déportée incluse

### ✗ Alimentatore escluso

Driver not included  
Alimentation non incluse





**Pop 80 T**



**DIFF. TRASP.**

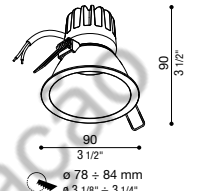

**IP65 IK 07 2J xx5**

LED	W	LM	REAL LM	COL.	CODE **	€	* OPTIC	* LED COLOUR
7	1000	820	220-240 V		LL14602W□□	58,00	S 25°	N 4000K
					LL14602B□□	68,00	M 45°	3 3000K, Im -5%
					LL14602Z□□	68,00	D Diff.	2 2700K, Im -5%
					LL14602U□□	68,00		
					LL14602G□□	68,00		
					LL14602A□□	68,00		
7	1000	820	500mA - 14V		LZ14602W□□	48,00		
					LZ14602B□□	58,00		
					LZ14602Z□□	58,00		
					LZ14602U□□	58,00		
					LZ14602G□□	58,00		
					LZ14602A□□	58,00		

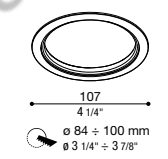

Codici LL14602A e LZ14602A in versione All Black con vetro serigrafato nero e anello adattatore nero.

Codes LL14602A and LZ14602A in All Black version with black serigraphed glass and black adapter ring.

Codes LL14602A et LZ14602A en version All Black avec verre sérigraphié noir et bague d'adaptation noire.

**Pop 80 T Asimmetrico**



**DIFF. TRASP.**

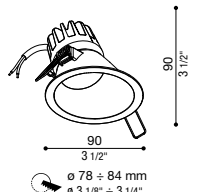

**IP65 IK 07 2J xx5**

LED	W	LM	REAL LM	COL.	CODE **	€	* OPTIC	* LED COLOUR
7	1000	850	220-240 V		LL14604W□□	58,00	S 25°	N 4000K
					LL14604B□□	68,00	M 45°	3 3000K, Im -5%
					LL14604Z□□	68,00	D Diff.	2 2700K, Im -5%
					LL14604U□□	68,00		
					LL14604G□□	68,00		
					LL14604A□□	68,00		
7	1000	850	500mA - 14V		LZ14604W□□	48,00		
					LZ14604B□□	58,00		
					LZ14604Z□□	58,00		
					LZ14604U□□	58,00		
					LZ14604G□□	58,00		
					LZ14604A□□	58,00		

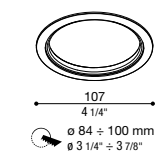

Codici LL14604A e LZ14604A in versione All Black con vetro serigrafato nero e anello adattatore nero.

Codes LL14604A and LZ14604A in All Black version with black serigraphed glass and black adapter ring.

Codes LL14604A et LZ14604A en version All Black avec verre sérigraphié noir et bague d'adaptation noire.

**\* Led colour**

- 4000K
- 3000K, Im -5%
- 2700K, Im -5%

**Completa il codice**

sostituendo al quadrato rosso la lettera o il numero corrispondente alla temperatura colore scelta.

**Complete the code**

by replacing the red box with the letter or number corresponding to the selected colour temperature.

**Compléter le code**

en remplaçant le carré rouge par la lettre ou le numéro correspondant à la sélection de température couleur.

**\* Optic**

- 

**Completa il codice**

sostituendo al quadrato grigio la lettera corrispondente al modello di ottica scelta.

**Complete the code**

by replacing the grey box with the letter corresponding to the selected optic model.

**Compléter le code**

en remplaçant le carré gris par la lettre correspondant au modèle de lentille choisie.

# Pop

## Pop 80 Q



DIFF. TRASP.

IP65 IK 07 2J xx5 CE UK CA

LED	W	LM	REAL LM	COL.	CODE * *	€	* OPTIC	* LED COLOUR
7	1000	820	220-240 V	LL14603W	58,00	S 25° M 45° D Diff.	N 4000K 3 3000K, Im -5% 2 2700K, Im -5%	
				LL14603B	68,00			
				LL14603Z	68,00			
				LL14603U	68,00			
				LL14603G	68,00			
				LL14603A	68,00			
7	1000	820	500mA - 14V	LZ14603W	48,00			
				LZ14603B	58,00			
				LZ14603Z	58,00			
				LZ14603U	58,00			
				LZ14603G	58,00			
				LZ14603A	58,00			

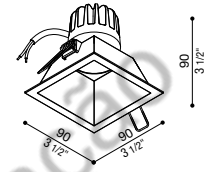

78x78 ÷ 84x84 mm  
3 1/8" x 3 1/8" ÷ 3 1/4" x 3 1/4"

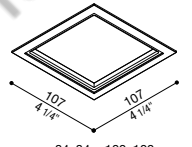

84x84 ÷ 100x100 mm  
3 1/4" x 3 1/4" ÷ 3 7/8" x 3 7/8"

Codici LL14603A e LZ14603A in versione All Black con vetro serigrafato nero e anello adattatore nero.

Codes LL14603A and LZ14603A in All Black version with black serigraphed glass and black adapter ring.

Codes LL14603A et LZ14603A en version All Black avec verre sérigraphié noir et bague d'adaptation noire.

## Pop 80 Q Asimmetrico



DIFF. TRASP.

IP65 IK 07 2J xx5 CE UK CA

LED	W	LM	REAL LM	COL.	CODE * *	€	* OPTIC	* LED COLOUR
7	1000	850	220-240 V	LL14605W	58,00	S 25° M 45° D Diff.	N 4000K 3 3000K, Im -5% 2 2700K, Im -5%	
				LL14605B	68,00			
				LL14605Z	68,00			
				LL14605U	68,00			
				LL14605G	68,00			
				LL14605A	68,00			
7	1000	850	500mA - 14V	LZ14605W	48,00			
				LZ14605B	58,00			
				LZ14605Z	58,00			
				LZ14605U	58,00			
				LZ14605G	58,00			
				LZ14605A	58,00			

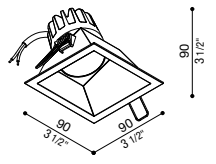

78x78 ÷ 84x84 mm  
3 1/8" x 3 1/8" ÷ 3 1/4" x 3 1/4"

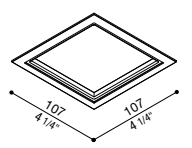

84x84 ÷ 100x100 mm  
3 1/4" x 3 1/4" ÷ 3 7/8" x 3 7/8"

Codici LL14605A e LZ14605A in versione All Black con vetro serigrafato nero e anello adattatore nero.

Codes LL14605A and LZ14605A in All Black version with black serigraphed glass and black adapter ring.

Codes LL14605A et LZ14605A en version All Black avec verre sérigraphié noir et bague d'adaptation noire.

### Finishing

	Bianco da stampaggio White Blanc moulé		Bianco - Rame White - Copper Blanc - Cuivre
	Bianco - Nero verniciato White - Black painted Blanc - Noir peint		Bianco - Silver White - Silver Blanc - Silver
	Bianco - Gold White - Gold Blanc - Gold		All Black All Black All Black

### \* Led colour

- N 4000K
- 3 3000K, Im -5%
- 2 2700K, Im -5%

**Completa il codice** sostituendo al quadrato rosso la lettera o il numero corrispondente alla temperatura colore scelta.

**Complete the code** by replacing the red box with the letter or number corresponding to the selected colour temperature.

**Compléter le code** en remplaçant le carré rouge par la lettre ou le numéro correspondant à la sélection de température couleur.

### ✓ Alimentatore incluso da remoto

Remote driver included  
Alimentation déportée incluse

### ✗ Alimentatore escluso

Driver not included  
Alimentation non incluse



**Pop 100 T**



**DIFF. TRASP.**

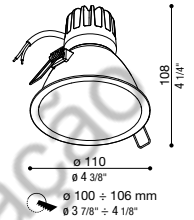

**IP65 IK 07 2J xx5**

LED	W	LM	REAL LM	COL.	CODE **	€	* OPTIC	* LED COLOUR
7	1000	800	220-240 V	LL14606W	58,00	S 25°	N 4000K	
				LL14606B	68,00	M 45°	3 3000K, Im -5%	
				LL14606Z	68,00	D Diff.	2 2700K, Im -5%	
				LL14606U	68,00			
				LL14606G	68,00			
7	1000	800	500mA - 14V	LZ14606A	68,00			
				LZ14606W	48,00			
				LZ14606B	58,00			
				LZ14606Z	58,00			
				LZ14606U	58,00			
				LZ14606G	58,00			
				LZ14606A	58,00			

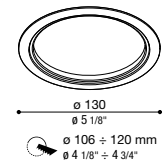

Codici LL14606A e LZ14606A in versione All Black con vetro serigrafato nero e anello adattatore nero.

Codes LL14606A and LZ14606A in All Black version with black serigraphed glass and black adapter ring.

Codes LL14606A et LZ14606A en version All Black avec verre sérigraphié noir et bague d'adaptation noire.

**ACCESSORI**

Accessories / Accessoires

**Alimentatori in corrente costante Pop**

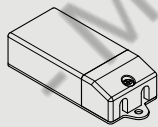

Drivers in constant current Pop

Alimentations à courant constant Pop

Prod	Spec	CC	N° max	IP	*	CODE	€
Pop	On-Off	350mA	1	20	≥60mm	LB1070009	33,00
Pop	On-Off	350mA	1/3	20	≥60mm	LB1070011	46,00
Pop	1-10 Push	350mA	1/3	20	≥72mm	LB1070012	69,00
Pop	On-Off	500mA	1/3	20	≥72mm	LB1070018	47,00
Pop	1-10 Push	500mA	1/3	20	≥72mm	LB1070019	67,50
Pop	Dali	Settable	1/3	20	≥72mm	LB1070064	88,00

\* Passante dal foro del prodotto.  
The driver can pass through the plasterboard hole of the product.  
Le alimentation électrique peut passer par le trou de la plaque de plâtre du produit.

**Convertitore Pop**

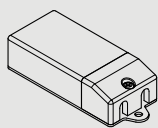

Voltage-current converter Pop

Convertisseur tension-courant Pop

Prod	Spec	N° max	IP	CODE	€
Pop	24V - 350mA	1	20	LB1460001	39,50
Pop	48V - 350mA	2	20	LB1460001	39,50
Pop	24V - 500mA	1	20	LB1460002	39,50
Pop	48V - 500mA	2	20	LB1460002	39,50



# Pop



Adattatore sempre incluso.  
Adapter always included.  
Adaptateur toujours inclus.

## POP 80T



adatto per foro  
suitable for  
convient pour

**Ø 78-84 MM**



con adattatore incluso  
with adapter  
avec adaptateur



adatto per foro  
suitable for  
convient pour

**Ø 84-100 MM**

## POP 80Q



Adatto per foro  
Suitable for  
Convient pour

**78-84 MM**



con adattatore incluso  
with adapter  
avec adaptateur



adatto per foro  
suitable for  
convient pour

**84-100 MM**

### Dimensioni foro cartongesso per:

Plasterboard hole dimension for all models:

Dimensions des trous pour plaques de plâtre pour tous les modèles:

**60 Q**     **62-66 mm**     con adattatore  
**60 T**     **66-78 mm**     with adapter  
avec adaptateur

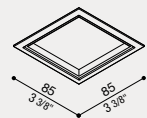
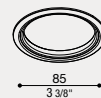

**80 QA**     **78-84 mm**     con adattatore  
**80 TA**     **84-100 mm**     with adapter  
**80 Q**     **84-100 mm**     avec adaptateur  
**80 T**

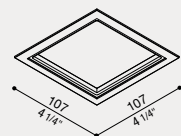
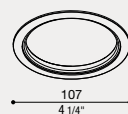

**100 T**     **100-106 mm**     con adattatore  
with adapter  
avec adaptateur     **106-120 mm**

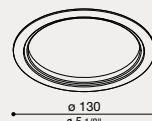



Diversi gradi di protezione:  
IP20 e IP65.

*Different degrees of  
protection: IP20 and IP65.*

*Différents degrés de  
protection : IP20 et IP65.*





# Pop

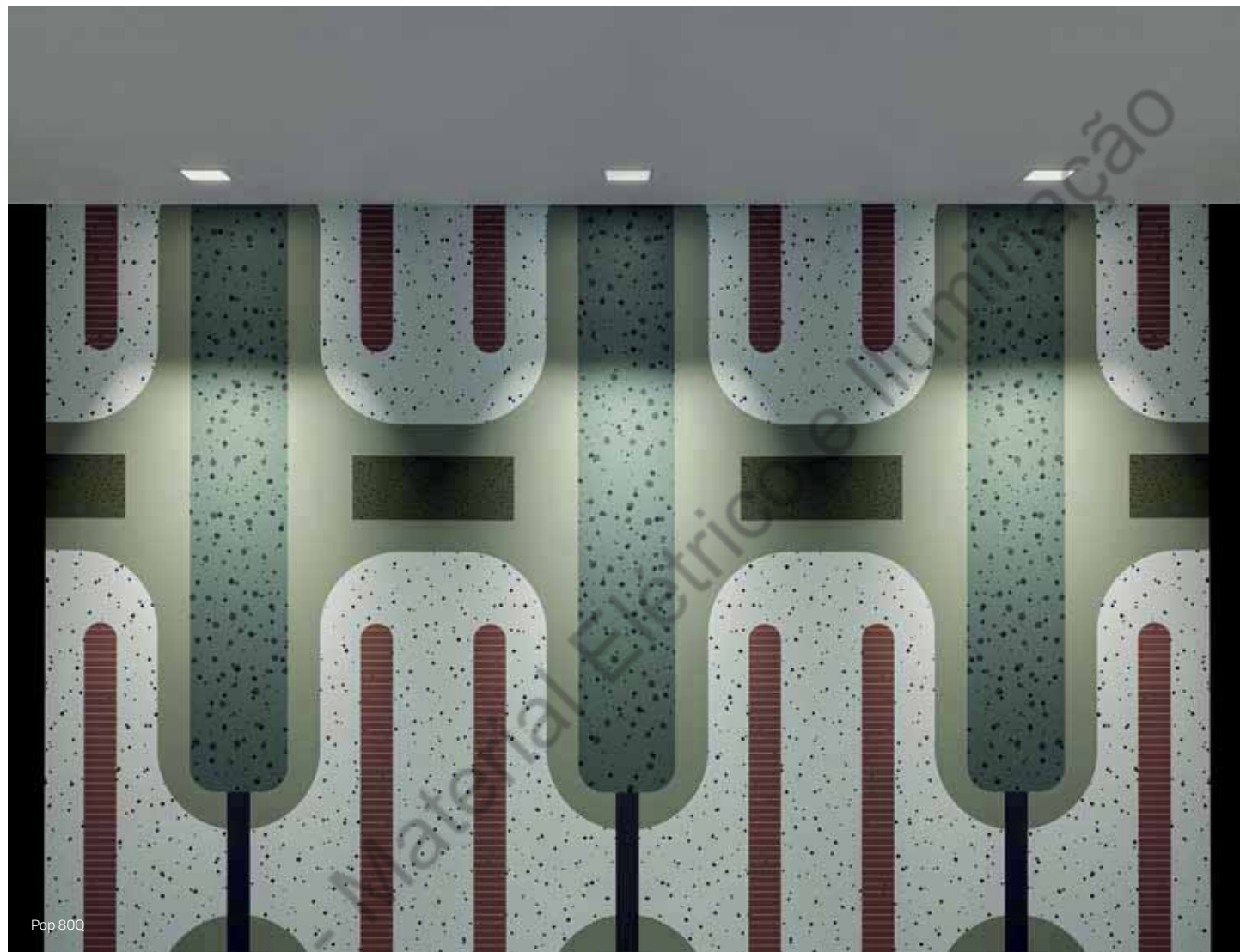

Pop 800



Pop 600

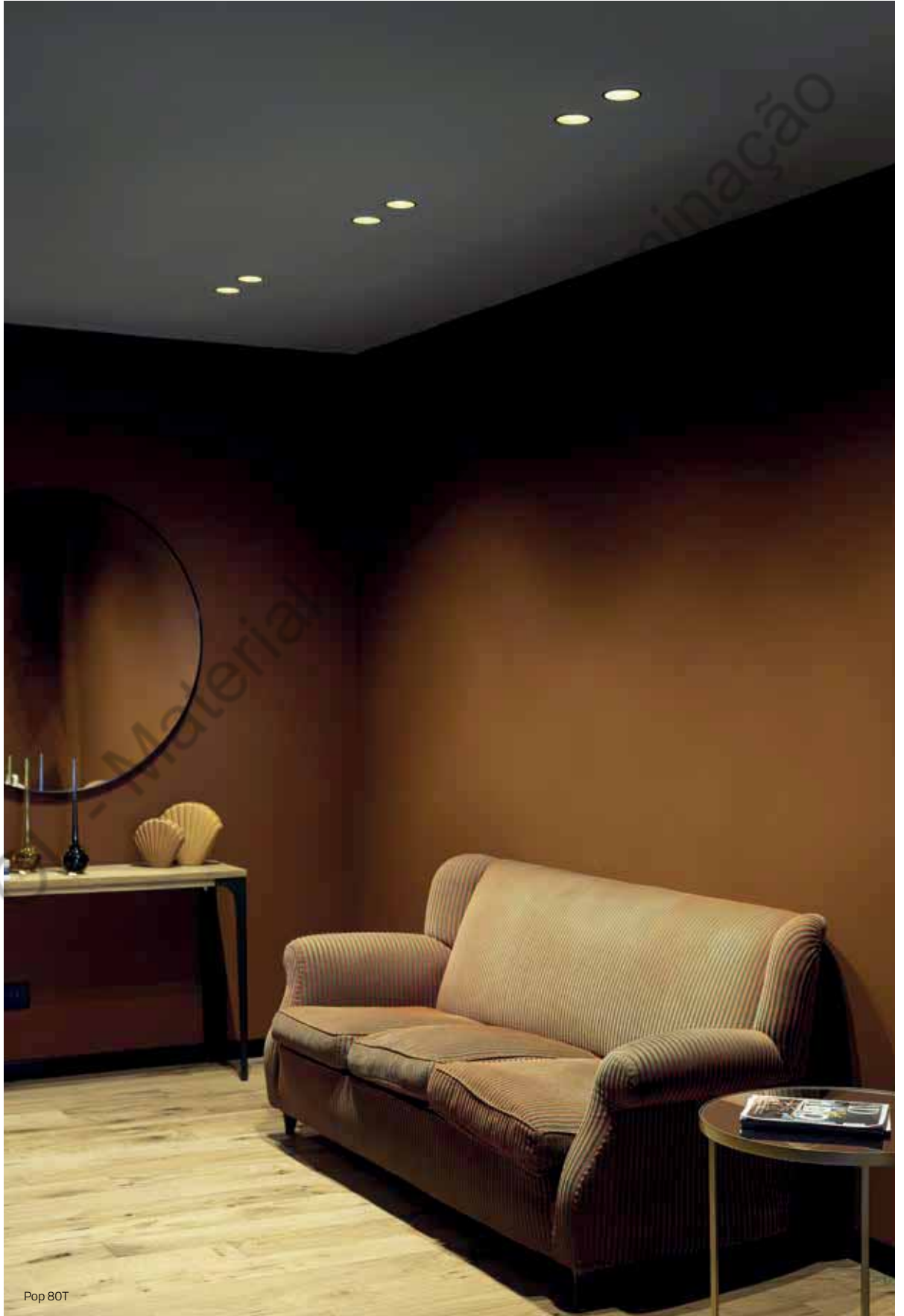

Pop 80T

# Pop





Pop 100T



Pop 80T

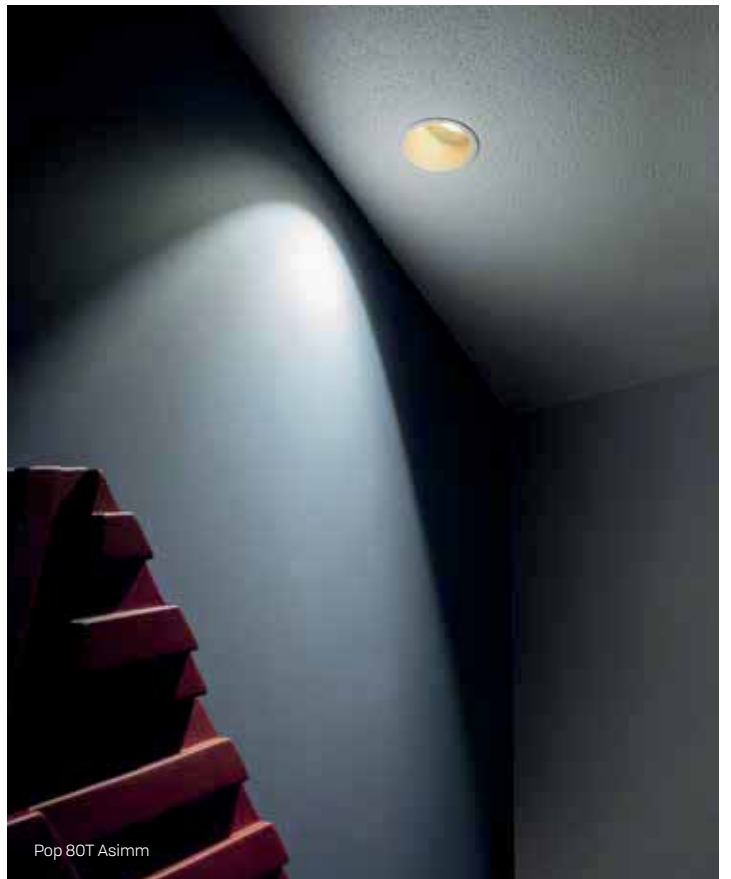

Pop 80T Asimm



# Downlight



LED



indoor





Adatto per installazioni in controsoffittature di cartongesso ad uso interno. Corpo in metallo zincato a freddo con elevata resistenza all'ossidazione, verniciato con resine di poliestere stabilizzate ai raggi UV. Dissipatore in alluminio lega 6060 T5, con trattamento di anodizzazione naturale. Diffusore in PMMA satinato. Installazione ad incasso tramite molle. Alimentatore incluso, esterno al prodotto. Dimmerazione disponibile. Bulloneria in acciaio inox A4 o AISI 316L. **LED 4000K (N) o 3000K (3). Alimentazione diretta 220-240V. Nessun rischio fotobiologico, RG0 gruppo di rischio esente (EN62471).**

**ENG** Suitable for installation on plasterboard walls and ceilings and for indoor use. Body made of cold galvanized metal, highly resistant to oxidization due to the UV stabilized polyester resin coating. Aluminium alloy 6060 T5 heat sink with natural anodizing treatment. Diffuser made of PMMA, satin effect, joined to the body by means of a silicone gasket. Recessed installation by means of retaining spring. Ballast included, external to the product. Dimmable version available. A4 or AISI 316L stainless steel nuts and bolts.

**LED 4000K (N) or 3000K (3). Integral ballast 220-240V. No risk of photobiological damage, RG0 group (EN62471).**

**FRA** Également adapté pour les installations murales et les faux plafonds en placoplâtre et à l'usage à l'extérieur.

Corps en métal zingué à froid dont la résistance à l'oxydation est très élevée, verni avec des résines de Polyester stabilisées aux rayons UV. Dissipateur en aluminium alliage 6060 T5, avec traitement d'anodisation naturelle. Diffuseur en

PMMA satiné, fixé au corps au moyen d'un joint en silicone.

Installation à encastrement au moyen de ressorts. Alimentateur inclus, extérieur au produit. Version dimmable disponible.

Fixation en acier inox type A4 ou AISI 316L.

**LED 4000K (N) ou 3000K (3) (blanche chaude). Alimentation intégrée 220-240. Pas de risque photobiologique, RG0 groupe (EN62471).**

**Downlight 120Q**



**Downlight 120T**



**Anni di garanzia sul circuito LED**

Years warranty on LED circuit  
Ans de garantie sur la source LED

# Downlight

## Downlight 120T

DIFF.  
POLIGLASS

Fino ad esaurimento.  
Until our stock lasts.  
Jusqu'à épuisement de stock.

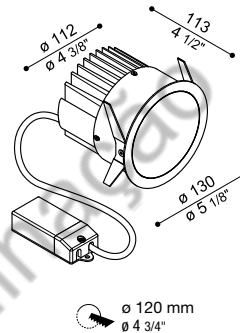

IP 40 IP 44 IK 06 1J xx3 CE UK CA

LED	W	LM	REAL LM		COL.	CODE *	€	* LED COLOUR
	18	2060	1356	<input type="checkbox"/> <input checked="" type="checkbox"/>	220-240 V	LL122012	232,50	<input type="checkbox"/> 4000K <input checked="" type="checkbox"/> 3000K, lm -5%
	18	2060	1356	<input type="checkbox"/> <input checked="" type="checkbox"/>	220-240 V 1-10V PUSH	LL122013	270,00	
	18	2060	1356	<input type="checkbox"/> <input checked="" type="checkbox"/>	220-240 V DALI	LL122014	293,50	
	22	2770	1681	<input type="checkbox"/> <input checked="" type="checkbox"/>	220-240 V	LL122015	303,50	
	22	2770	1681	<input type="checkbox"/> <input checked="" type="checkbox"/>	220-240 V 1-10V PUSH	LL122016	318,00	
	22	2770	1681	<input type="checkbox"/> <input checked="" type="checkbox"/>	220-240 V DALI	LL122017	341,00	

Versione tonda. Peso prodotto: 2 kg.

Round version. Product weight: 2 Kg/4.40Lb.

Version ronde. Poids produit: 2 kg/4.40Lb.

## Downlight 120Q

DIFF.  
POLIGLASS

Fino ad esaurimento.  
Until our stock lasts.  
Jusqu'à épuisement de stock.

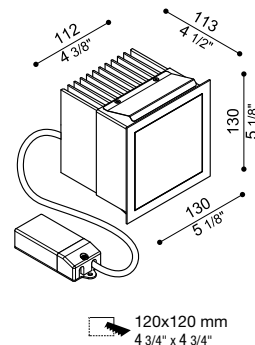

IP 40 IP 44 IK 06 1J xx3 CE UK CA

LED	W	LM	REAL LM		COL.	CODE *	€	* LED COLOUR
	18	2060	1335	<input type="checkbox"/> <input checked="" type="checkbox"/>	220-240 V	LL122018	218,50	<input type="checkbox"/> 4000K <input checked="" type="checkbox"/> 3000K, lm -5%
	18	2060	1335	<input type="checkbox"/> <input checked="" type="checkbox"/>	220-240 V 1-10V PUSH	LL122019	256,00	
	18	2060	1335	<input type="checkbox"/> <input checked="" type="checkbox"/>	220-240 V DALI	LL122020	279,00	
	22	2770	1615	<input type="checkbox"/> <input checked="" type="checkbox"/>	220-240 V	LL122021	281,00	
	22	2770	1615	<input type="checkbox"/> <input checked="" type="checkbox"/>	220-240 V 1-10V PUSH	LL122022	293,50	
	22	2770	1615	<input type="checkbox"/> <input checked="" type="checkbox"/>	220-240 V DALI	LL122023	318,00	

Versione quadrata. Peso prodotto: 2.5 kg.

Square version. Product weight: 2.5 Kg/5.51Lb.

Version carrée. Poids produit: 2.5 kg/5.51Lb.

### Finishing

Bianco RAL 9010  
 White RAL 9010  
 Blanc RAL 9010

### \* Led colour

4000K  
 3000K, lm -5%

**Completa il codice**  
sostituendo al quadrato rosso la lettera o il numero corrispondente alla temperatura colore scelta.

**Complete the code**  
by replacing the red box with the letter or number corresponding to the selected colour temperature.

**Compléter le code**  
en remplaçant le carré rouge par la lettre ou le numéro correspondant à la sélection de température couleur.

**Alimentatore incluso da remoto**  
Remote driver included  
Alimentation déportée incluse

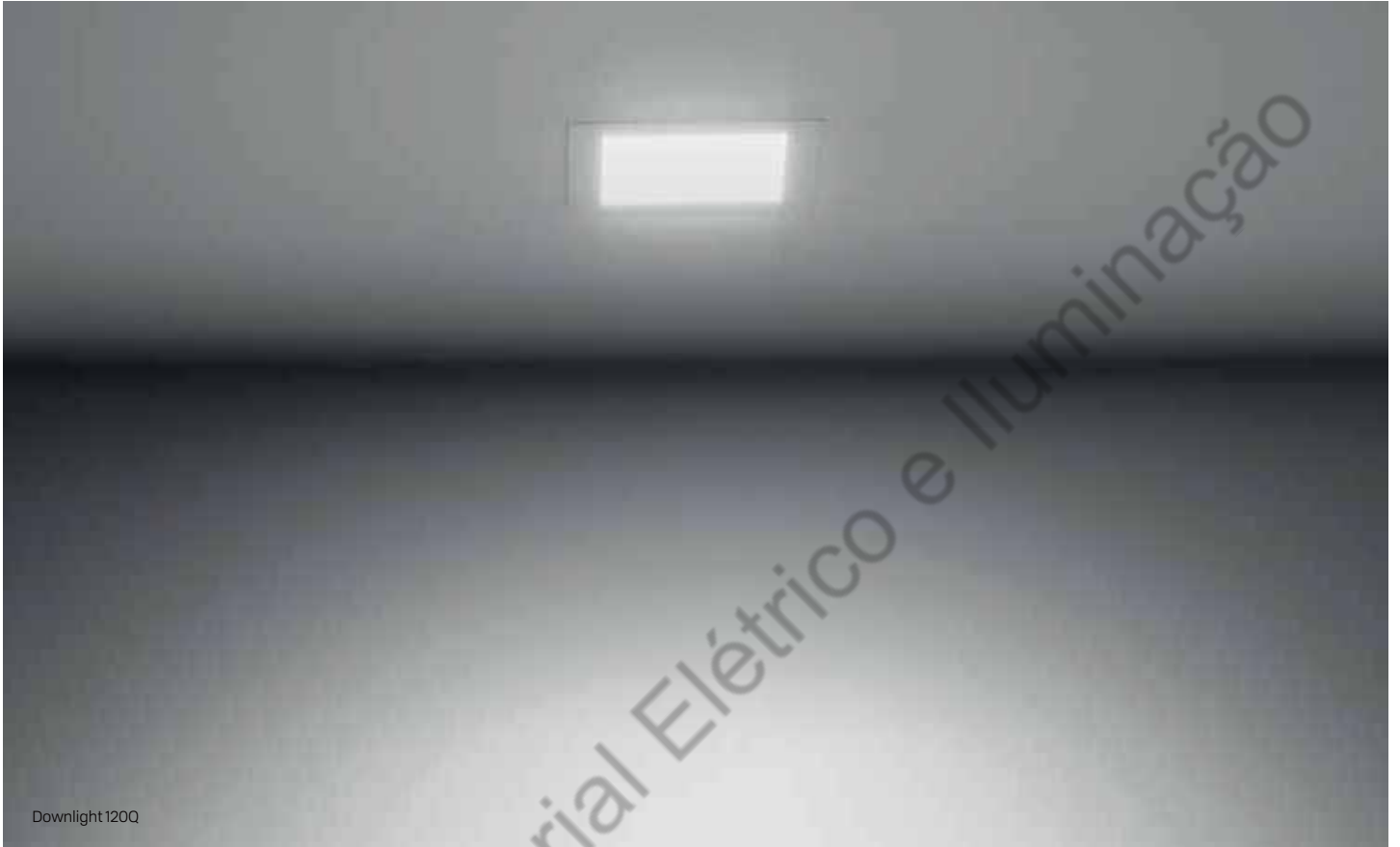

Downlight 120Q



Downlight 120T

# Kura



1 KURA TOP



2



3



# Kura



LED



indoor



outdoor

**ACCESSORI**

Accessories / Accessoires

Pag. 303



Adatto per installazioni in controsoffittature di cartongesso ad uso interno ed esterno. Corpo in policarbonato. Dissipatore in alluminio primario pressofuso EN-AB44100. Lenti in PMMA. Installazione ad incasso tramite molle. Alimentatore esterno al prodotto. Fornito con 0,20m di cavo in PVC 2x0,25mm . Dimmerazione disponibile. Bulloneria in acciaio inox A4 o AISI 316L.

Codici LL: forniti con alimentatore esterno al prodotto. Alimentazione diretta 220-240V.

Codici LZ: alimentazione esclusa.

**LED 4000K (N), 3000K (3) e 2700K (2). Nessun rischio fotobiologico, RGO gruppo di rischio esente (EN62471).**

**ENG** Suitable for installation in plasterboard ceilings for indoor and outdoor use. Polycarbonate body. Die-cast primary aluminium heat sink EN-AB44100. PMMA lenses. Recessed installation by means of springs. External power supply. Supplied with 0,20m PVC cable 2x0.25mm . Dimming available. Stainless steel A4 or AISI 316L hardware. LL codes: supplied with external driver. Direct power supply 220-240V. LZ codes: power supply excluded. **LED 4000K (N), 3000K (3) and 2700K (2). No photobiological risk, RGO risk group exempt (EN62471).**

**FRA** Convient pour une installation dans les plafonds en plaques de plâtre pour une utilisation intérieure et extérieure. Corps en polycarbonate. Dissipateur thermique en aluminium primaire moulé sous pression EN-AB44100. Lentilles en PMMA. Installation encastrée au moyen de ressorts. Alimentation externe. Fourni avec un câble PVC 2x0.25mm de 0,20 m. Gradation disponible. Boulons en acier inoxydable A4 ou AISI 316L. Codes LL : fournis avec une unité d'alimentation externe. Alimentation électrique directe 220-240V. Codes LZ : alimentation exclue. **LED 4000K (N), 3000K (3) et 2700K (2). Pas de risque photobiologique, RGO groupe (EN62471).**

**Kura X1**

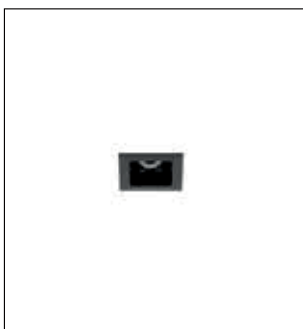

**Kura X3**

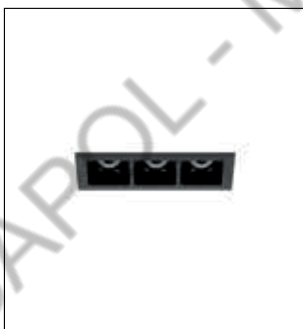

**Kura X5**

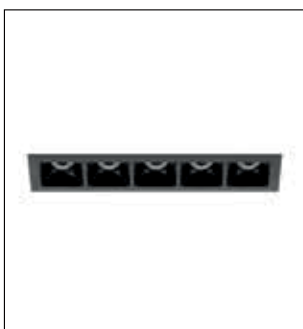

**Outdoor e waterproof**











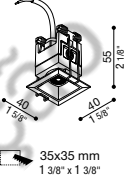















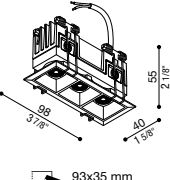

**Pre-cablato**  
Pre-wired  
Pré-câblé











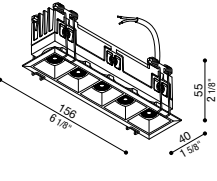



**Anni di garanzia sul circuito LED**  
Years warranty on LED circuit  
Ans de garantie sur la source LED



# Kura

<b>Kura X1</b>				DIFF. TRASP.					
IP 65 IK 06 1J xx3 C $\text{UK}$ $\text{CA}$									
LED	W	LM	REAL LM	COL.	CODE **	€	* OPTIC	* LED COLOUR	
	2	180	150	  220-240 V		LL14701W 	49,00	S 18° M 28° L 52° E 11 X 37°	N 4000K 3 3000K, Im -5% 2 2700K, Im -5%
	2	180	150	  700mA - 3V		LL14701B 	49,00		
						LZ14701W 	39,00		
						LZ14701B 	39,00		



<b>Kura X3</b>				DIFF. TRASP.					
IP 65 IK 06 1J xx3 C $\text{UK}$ $\text{CA}$									
LED	W	LM	REAL LM	COL.	CODE **	€	* OPTIC	* LED COLOUR	
	6	540	510	  220-240 V		LL14702W 	85,00	S 18° M 28° L 52° E 11 X 37°	N 4000K 3 3000K, Im -5% 2 2700K, Im -5%
	6	540	510	  700mA - 9V		LL14702B 	85,00		
						LZ14702W 	69,00		
						LZ14702B 	69,00		

<b>Kura X5</b>				DIFF. TRASP.					
IP 65 IK 06 1J xx3 C $\text{UK}$ $\text{CA}$									
LED	W	LM	REAL LM	COL.	CODE **	€	* OPTIC	* LED COLOUR	
	10	900	840	  220-240 V		LL14703W 	109,00	S 18° M 28° L 52° E 11 X 37°	N 4000K 3 3000K, Im -5% 2 2700K, Im -5%
	10	900	840	  700mA - 15V		LL14703B 	109,00		
						LZ14703W 	93,00		
						LZ14703B 	93,00		

## Finishing

	Bianco da stampaggio White Blanc moulé
	Nero da stampaggio Black Noir moulé

## \* Led colour

-  4000K
-  3000K, Im -5%
-  2700K, Im -5%

**Completa il codice**  
sostituendo al quadrato rosso la lettera o il numero corrispondente alla temperatura colore scelta.

**Complete the code**  
by replacing the red box with the letter or number corresponding to the selected colour temperature.

**Compléter le code**  
en remplaçant le carré rouge par la lettre ou le numéro correspondant à la sélection de température couleur.

## ✓ Alimentatore incluso da remoto

Remote driver included  
Alimentation déportée incluse

## ✗ Alimentatore escluso

Driver not included  
Alimentation non incluse



**ACCESSORI**

Accessories / Accessoires

**Alimentatori in corrente costante Kura**

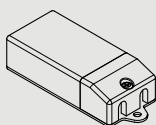

Drivers in constant current  
Kura X1

Alimentations à courant constant  
Kura X1

Prod	Spec	CC	N° max	IP	*	CODE	€
Kura x1	On-Off	700mA	1/4	20	✓ H≥120mm	LB1070071	40,50
Kura x1	Dali	700mA	1/8	20	✗	LB1070072	89,50
Kura x1	1-10 Push	700mA	1/8	20	✗	LB1070074	95,50
Kura x3	On-Off	700mA	2/4	20	✗	LB1070073	37,50
Kura x3	Dali	700mA	1/4	20	✓ H≥120mm	LB1070064	88,00
Kura x3	Dali 1-10 Push	700mA	1/7	20	✓ H≥150mm	LB1070066	134,00
Kura x3	1-10 Push	700mA	2/4	20	✓ H≥120mm	LB1070043	67,50
Kura x5	On-Off	700mA	1/3	20	✓ H≥160mm	LB1070073	37,50
Kura x5	Dali 1-10 Push	700mA	1/4	20	✓ H≥150mm	LB1070066	134,00
Kura x5	Dali	700mA	1/3	20	✓ H≥120mm	LB1070064	88,00

\* Passante dal foro del prodotto e altezza minima (H) del controsoffitto.  
 The driver can pass through the plasterboard hole of the product and minimum height (H) between ceiling and plasterboard.  
 Le alimentation électrique peut passer par le trou de la plaque de plâtre du produit et hauteur minimale (H) du faux plafond.

**Convertitore Kura**

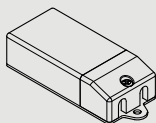

Voltage-current converter Kura

Convertisseur tension-courant  
Kura

Prod	Spec	N° max	IP	CODE	€
Kura x1	24V - 700mA	6	20	LB1470001	47,00
Kura x1	48V - 700mA	12	20	LB1470001	47,00
Kura x2	24V - 700mA	3	20	LB1470001	47,00
Kura x2	48V - 700mA	6	20	LB1470001	47,00
Kura x3	24V - 700mA	2	20	LB1470001	47,00
Kura x3	48V - 700mA	4	20	LB1470001	47,00
Kura x5	24V - 700mA	1	20	LB1470001	47,00
Kura x5	48V - 700mA	2	20	LB1470001	47,00



Protezione IP65 sull'intero prodotto.  
 IP65 protection on the entire product.  
 Protection IP65 sur l'ensemble du produit.

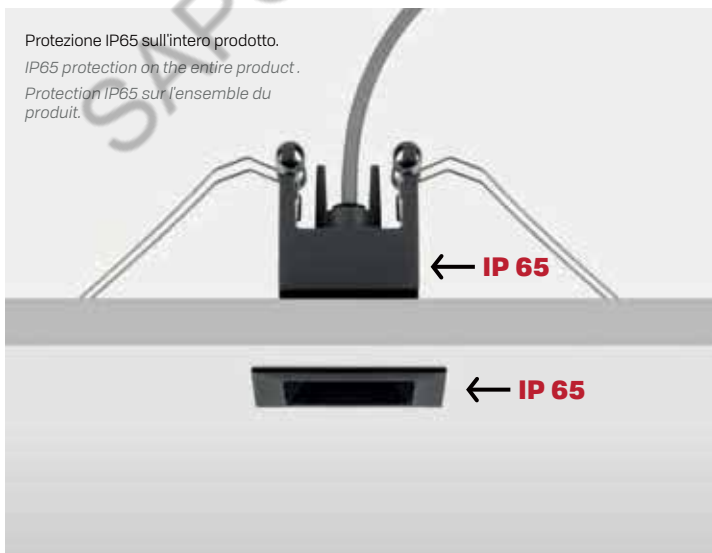

# Kura



Kura X1



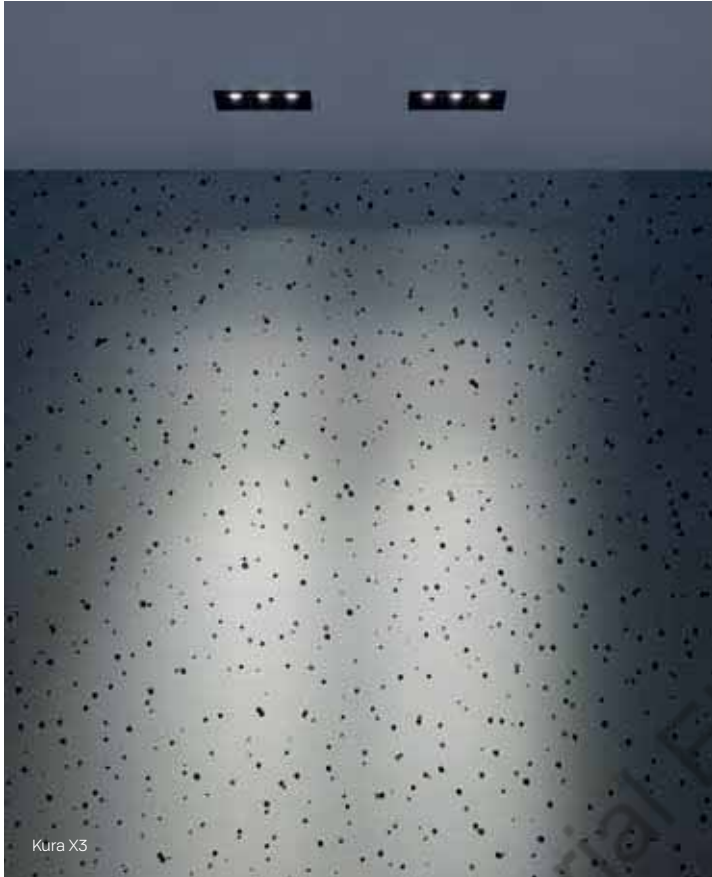

Kura X3



Kura X5



Kura X3

# Kura Top

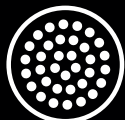

LED

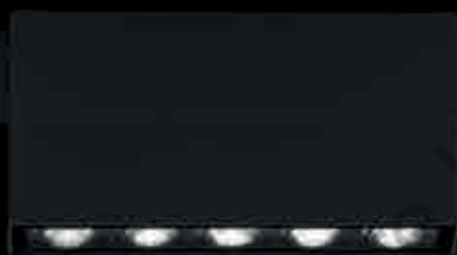

indoor



outdoor

**ACCESSORI**

Accessories / Accessoires

Pag. 309



Adatto per installazioni a soffitto ad uso interno ed esterno.  
 Corpo in alluminio pressofuso EN-AB44100, staffa di fissaggio in tecnopolimero.  
 Diffusore in vetro temprato e serigrafato. Riflettori in policarbonato.  
 Guarnizioni in silicone per il mantenimento del grado IP 65.  
 Bulloneria in acciaio inox A4. LED di ultima generazione CRI > 95.  
 Codici LL: alimentazione diretta 220-240V.  
 Codici LZ: alimentazione esclusa.

**LED 4000K (N), 3000K (3) e 2700K (2).**

**Nessun rischio fotobiologico, RGO gruppo di rischio esente (EN62471).**

**ENG** Suitable for indoor and outdoor ceiling installations.  
 Die-cast aluminium body EN-AB44100, technopolymer fixing bracket.  
 Silk-screened tempered glass diffuser. Polycarbonate reflectors.  
 Silicone gaskets to maintain IP 65 rating.  
 A4 stainless steel hardware. Latest generation LED CRI > 95.  
 LL codes: direct power supply 220-240V.  
 LZ codes: power supply excluded.  
**4000K (N), 3000K (3) and 2700K (2) LED.**  
 No photobiological risk, RGO risk group exempt (EN62471).

**FRA** Convient aux installations de plafond intérieures et extérieures.  
 Corps en aluminium moulé sous pression EN-AB44100, support de fixation en technopolymère.  
 Diffuseur en verre trempé sérigraphié. Réflecteurs en polycarbonate.  
 Joints en silicone pour maintenir l'indice IP 65.  
 Boulons en acier inoxydable A4. LED de dernière génération IRC > 95  
 Codes LL: alimentation électrique directe 220-240V.  
 Codes LZ: alimentation exclue.  
**LED 4000K (N), 3000K (3) et 2700K (2).**  
 Pas de risque photobiologique, RGO groupe (EN62471).

**Kura Top X1**



**Kura Top X2**



**Kura Top X5**



**Outdoor  
 e waterproof**



**Cataforesi**  
 Cataphoresis  
 Cataphorèse



**Anni di garanzia  
 sul circuito LED**  
 Years warranty on LED circuit  
 Ans de garantie sur la source LED

# Kura Top

## Kura Top X1

NEW

DIFF.  
VETRO

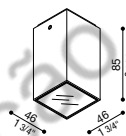

IP 65 IK 06 1J xx3 C  $\frac{UK}{CA}$

LED	W	LM	REAL LM	COL.	CODE **	€	* OPTIC	* LED COLOUR
2	180	140	700mA - 3V		LZ14704W□	59,00	S 18°	N 4000K
					LZ14704L□	59,00	M 28°	3 3000K, Im -5%
					LZ14704D□	59,00	L 52°	2 2700K, Im -5%
					LZ14704K□	59,00	E 11 X 37°	

## Kura Top X2

NEW

DIFF.  
VETRO

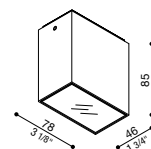

IP 65 IK 06 1J xx3 C  $\frac{UK}{CA}$

LED	W	LM	REAL LM	COL.	CODE **	€	* OPTIC	* LED COLOUR
4	360	310	220-240 V		LL14705W□	105,00	S 18°	N 4000K
					LL14705L□	105,00	M 28°	3 3000K, Im -5%
					LL14705D□	105,00	L 52°	2 2700K, Im -5%
					LL14705K□	105,00	E 11 X 37°	
4	360	310	700mA - 6V		LZ14705W□	90,00		
					LZ14705L□	90,00		
					LZ14705D□	90,00		
					LZ14705K□	90,00		

## Kura Top X5

NEW

DIFF.  
VETRO

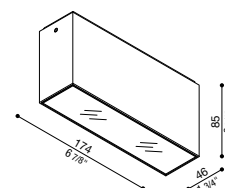

IP 65 IK 06 1J xx3 C  $\frac{UK}{CA}$

LED	W	LM	REAL LM	COL.	CODE **	€	* OPTIC	* LED COLOUR
10	900	785	220-240 V		LL14706W□	140,00	S 18°	N 4000K
					LL14706L□	140,00	M 28°	3 3000K, Im -5%
					LL14706D□	140,00	L 52°	2 2700K, Im -5%
					LL14706K□	140,00	E 11 X 37°	
10	900	785	700mA - 15V		LZ14706W□	115,00		
					LZ14706L□	115,00		
					LZ14706D□	115,00		
					LZ14706K□	115,00		

### Finishing

Bianco RAL 9003  
 White RAL 9003  
 Blanc RAL 9003  
 Light Grey RAL 7044  
 Light Grey RAL 7044  
 Gris Pale RAL 7044

Dark Grey RAL 7021  
 Dark Grey RAL 7021  
 Gris Foncé RAL 7021  
 Corten  
 Corten  
 Corten

### \* Led colour

4000K  
 3000K, Im -5%  
 2700K, Im -5%

**Completa il codice**  
sostituendo al quadrato rosso la lettera o il numero corrispondente alla temperatura colore scelta.

**Complete the code**  
by replacing the red box with the letter or number corresponding to the selected colour temperature.

**Compléter le code**  
en remplaçant le carré rouge par la lettre ou le numéro correspondant à la sélection de température couleur.

### ✓ Alimentatore integrato

Integrated driver  
Alimentation intégrée

### ✗ Alimentatore escluso

Driver not included  
Alimentation non incluse



**ACCESSORI**

Accessories / Accessoires

**Alimentatori in corrente costante Kura**

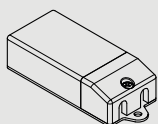

Drivers in constant current  
Kura X1

Alimentations à courant constant  
Kura X1

Prod	Spec	CC	N° max	IP	CODE	€
Kura Top x1	On-Off	700mA	1/4	20	LB1070071	40,50
Kura Top x1	Dali	700mA	1/8	20	LB1070072	89,50
Kura Top x1	1-10 Push	700mA	1/8	20	LB1070074	95,50
Kura Top x2	On-Off	700mA	1/2	20	LB1070071	40,50
Kura Top x2	Dali	700mA	1/8	20	LB1070072	89,50
Kura Top x2	1-10 Push	700mA	1/7	20	LB1070074	95,50
Kura Top x5	On-Off	700mA	1/3	20	LB1070073	37,50
Kura Top x5	Dali 1-10 Push	700mA	1/4	20	LB1070066	134,00
Kura Top x5	Dali	700mA	1/3	20	LB1070064	88,00

**Convertitore Kura**

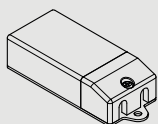

Voltage-current converter Kura

Convertisseur tension-courant  
Kura

Prod	Spec	N° max	IP	CODE	€
Kura Top x1	24V - 700mA	6	20	LB1470001	47,00
Kura Top x1	48V - 700mA	12	20	LB1470001	47,00
Kura Top x2	24V - 700mA	3	20	LB1470001	47,00
Kura Top x2	48V - 700mA	6	20	LB1470001	47,00
Kura Top x5	24V - 700mA	1	20	LB1470001	47,00
Kura Top x5	48V - 700mA	2	20	LB1470001	47,00

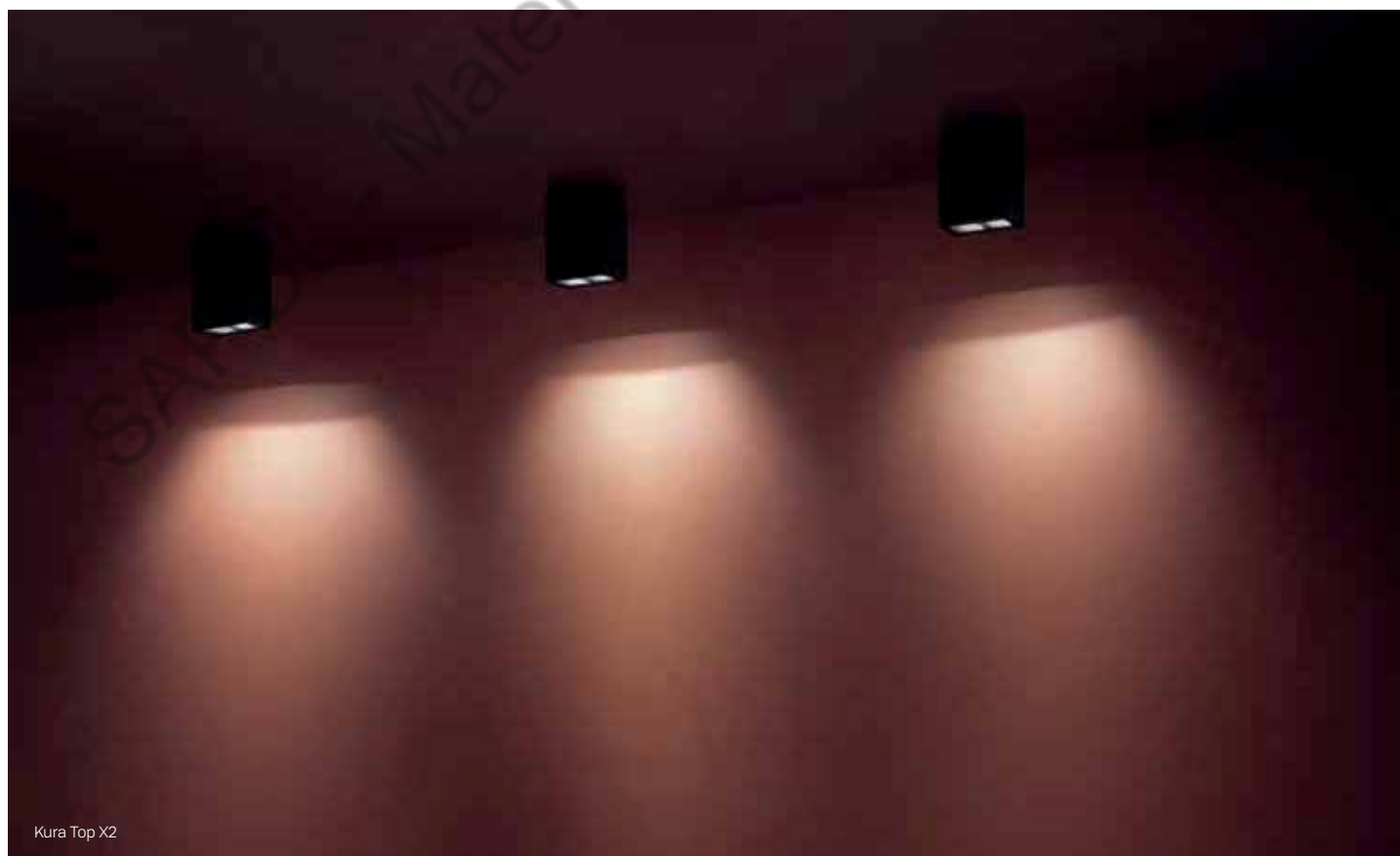

Kura Top X2



# Kura Top

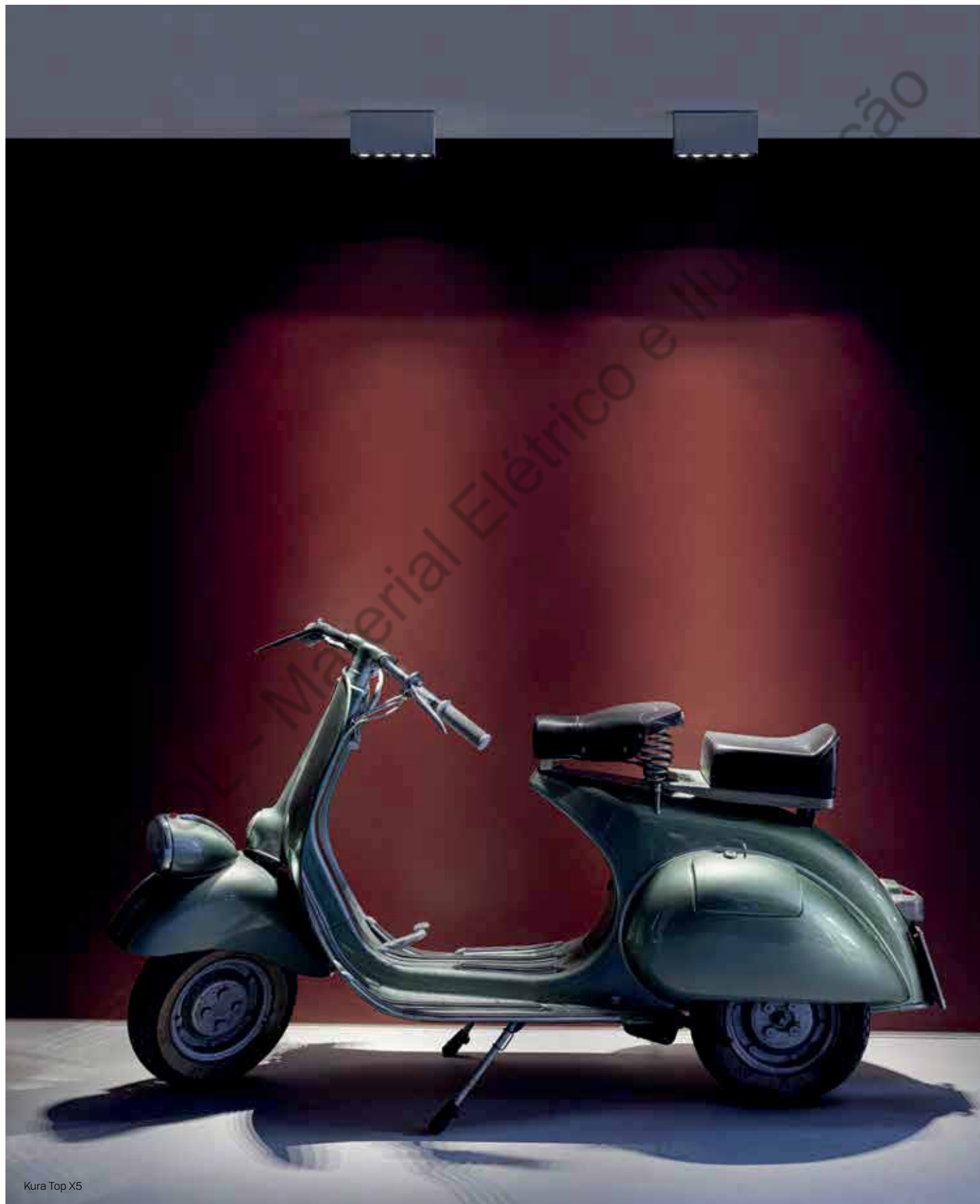



Kura Top X1

Kura Top X1

# Kura Reg

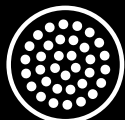

LED



indoor



outdoor

**ACCESSORI**

Accessories / Accessoires

Pag. 314



Adatto per installazioni a soffitto e parete ad uso interno ed esterno.  
 Corpo in alluminio pressofuso EN-AB44100, staffa di fissaggio in acciaio inox.  
 Diffusore in vetro temprato e serigrafato. Riflettori in policarbonato.  
 Regolazione inclinazione di 90° e rotazione di 210°.  
 Guarnizioni in silicone per il mantenimento del grado IP 65.  
 Bulloneria in acciaio inox A4. LED di ultima generazione CRI > 95.  
 Codici LL: alimentazione diretta 220-240V.  
 Codici LZ: alimentazione esclusa.

**LED 4000K (N), 3000K (3) e 2700K (2).**

**Nessun rischio fotobiologico, RGO gruppo di rischio esente (EN62471).**

**ENG** Suitable for ceiling and wall installation for indoor and outdoor use.  
 Die-cast aluminium body EN-AB44100, stainless steel fixing bracket.  
 Heat tempered and serigraphed glass diffuser. Polycarbonate reflectors.  
 90° tilt and 210° rotation adjustment. Silicone gaskets for maintaining IP  
 65 rating.  
 A4 stainless steel hardware. Latest generation LEDs CRI > 95.  
 LL codes: direct power supply 220-240V.  
 LZ codes: power supply excluded.  
**4000K (N), 3000K (3) and 2700K (2) LED.**  
 No photobiological risk, RGO risk group exempt (EN62471).

**FRA** Convient à une installation au plafond et au mur pour une utilisation  
 intérieure et extérieure.  
 Corps en aluminium moulé sous pression EN-AB44100, support de  
 fixation en acier inoxydable.  
 Diffuseur en verre trempé sérigraphié. Réflecteurs en polycarbonate.  
 Réglage de l'inclinaison à 90° et de la rotation à 210°.  
 Joints en silicone pour le maintien indice IP 65.  
 Boulons en acier inoxydable A4. LED de dernière génération IRC > 95.  
 Codes LL: alimentation électrique directe 220-240V.  
 Codes LZ: alimentation exclue.  
**LED 4000K (N), 3000K (3) et 2700K (2).**  
 Pas de risque photobiologique, exemption du groupe de risque RGO  
 (EN62471).

**Kura Reg X2**



**Outdoor  
 e waterproof**



**Cataforesi**  
 Cataphoresis  
 Cataphorèse



**Anni di garanzia  
 sul circuito LED**  
 Years warranty on LED circuit  
 Ans de garantie sur la source LED

# Kura Reg

## Kura Reg X2

NEW

DIFF. VETRO

IP 65 IK 06 1J xx3 CE UK CA

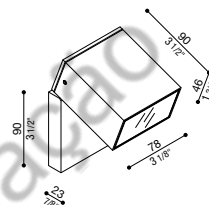

LED	W	LM	REAL LM	COL.	CODE **	€	* OPTIC	* LED COLOUR
4	360	310	220-240 V	LL14707W	149,00	S 18° M 28° L 52° E 11 X 37°	N 4000K 3 3000K, Im -5% 2 2700K, Im -5%	
				LL14707L	149,00			
				LL14707D	149,00			
				LL14707K	149,00			
4	360	310	700mA - 6V	LZ14707W	135,00			
				LZ14707L	135,00			
				LZ14707D	135,00			
				LZ14707K	135,00			

## ACCESSORI

Accessories / Accessoires

### Alimentatori in corrente costante Kura X2

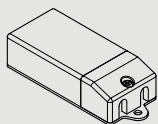

Drivers in constant current Kura X2

Alimentations à courant constant Kura X2

Prod	Spec	CC	N° max	IP	CODE	€
Kura Reg x2	On-Off	700mA	1/2	20	LB1070071	40,50
Kura Reg x2	Dali	700mA	1/8	20	LB1070072	89,50
Kura Reg x2	1-10 Push	700mA	1/7	20	LB1070074	95,50

### Convertitore Kura

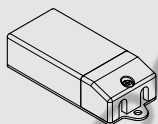

Voltage-current converter Kura

Convertisseur tension-courant Kura

Prod	Spec	N° max	IP	CODE	€
Kura Reg x2	24V - 700mA	3	20	LB1470001	47,00
Kura Reg x2	48V - 700mA	6	20	LB1470001	47,00

### Finishing

	Bianco RAL 9003 White RAL 9003 Blanc RAL 9003		Dark Grey RAL 7021 Dark Grey RAL 7021 Gris Foncé RAL 7021
	Light Grey RAL 7044 Light Grey RAL 7044 Gris Pale RAL 7044		Corten Corten Corten

### \* Led colour

- N 4000K
- 3 3000K, Im -5%
- 2 2700K, Im -5%

**Completa il codice** sostituendo al quadrato rosso la lettera o il numero corrispondente alla temperatura colore scelta.

**Complete the code** by replacing the red box with the letter or number corresponding to the selected colour temperature.

**Compléter le code** en remplaçant le carré rouge par la lettre ou le numéro correspondant à la sélection de température couleur.

### ✓ Alimentatore integrato

Integrated driver  
Alimentation intégrée

### ✗ Alimentatore escluso

Driver not included  
Alimentation non incluse



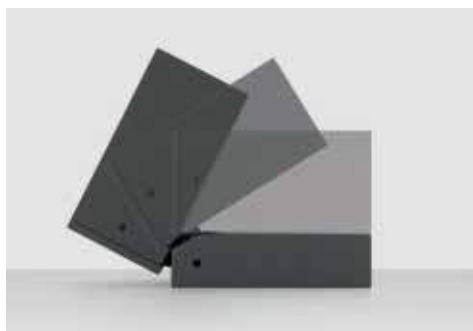

Inclinazione di 90°.  
90° tilt.  
Inclinaison à 90°.



Rotazione di 210°  
210° rotation.  
Rotation à 210°.



Rotazione e inclinazione combinate.  
Combined rotation and tilting.  
Rotation et inclinaison combinées.



# Dodo

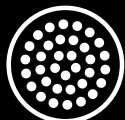

LED



indoor



outdoor



Adatto anche ad uso esterno. Corpo in alluminio pressofuso; elevata resistenza all'ossidazione grazie al trattamento di cataforesi e alla verniciatura con resine poliester stabilizzata ai raggi UV.

Diffusore in policarbonato trasparente. Predisposto per singolo ingresso alimentazione.

Fornito con accessori per la regolazione dell'apertura del fascio luminoso.

Guarnizioni in silicone. Bulloneria in acciaio inox A4.

**Dodo 60:** LED a tensione di rete, dimmerabile a taglio di fase.

**Dodo 100 e Dodo 300:** Alimentazione diretta 220-240V.

**LED 4000K (N), 3000K (3) o 2700K (2). Nessun rischio fotobiologico, RG0 gruppo di rischio esente (EN62471).**

**ENG** Also suitable for outdoor use.

Die-cast aluminium body; high resistance to oxidation thanks to cathoresis treatment and UV-stabilised polyester resin painting. Transparent polycarbonate diffuser. Prepared for a single cable entry at the back. Supplied with accessories for adjusting the opening of the light beam. Silicone gaskets. A4 stainless steel hardware.

**Dodo 60:** LED AC Direct, phase-cut dimmable.

**Dodo 100 and Dodo 300:** Integral ballast 220-240V.

**LED 4000K (N), 3000K (3) or 2700K (2). No photobiological risk, RG0 risk group exempt (EN62471).**

**FRA** Également à l'usage à l'extérieur.

Corps en aluminium moulé sous pression; haute résistance à l'oxydation grâce au traitement par cathorèse et à la peinture en résine polyester stabilisée aux UV. Diffuseur en polycarbonate transparent. Préparé pour une seule entrée d'alimentation. Fourni avec des accessoires permettant de régler l'ouverture du faisceau lumineux. Joints en silicone. Visserie en acier inoxydable A4.

**Dodo 60:** LED AC direct, dimmable coupure de phase.

**Dodo 100 et Dodo 300:** alimentation intégrée 220-240V.

**LED 4000K (N), 3000K (3) ou 2700K (2). Pas de risque photobiologique, RG0 groupe (EN62471).**

**Dodo 60**



**Dodo 60 Full**



**Outdoor e waterproof**



**Cataforesi**  
Cathoresis  
Cataphorèse

**Dodo 100**



**Dodo 100 Full**



**Alimentazione diretta**

Direct power supply  
Alimentation directe



**Anni di garanzia sul circuito LED**

Years warranty on LED circuit  
Ans de garantie sur la source LED

**Dodo 300**



# Dodo

## Dodo 60

NEW

DIFF.  
TRASP.

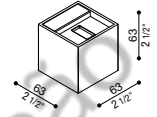

IP 54 IK 10 20J xx9 CE UK CA

LED	W	LM	REAL LM	COL.	CODE *	€	* LED COLOUR
3	360	120	AC DIRECT		LL14301W□	85,00	N 4000K
					LL14301L□	85,00	3 3000K, lm -5%
					LL14301D□	85,00	2 2700K, lm -5%
					LL14301Z□	85,00	

Fasci disponibili: 15°, 30°, 60°, regolabili tramite mascherine sostituibili.

Available light beams: 15°, 30°, 60°, adjustable with removable masks.

Faisceaux disponibles : 15°, 30°, 60°, réglables avec masques amovibles.

## Dodo 60 Full

NEW

DIFF.  
TRASP.

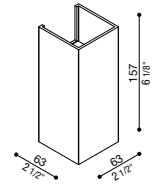

IP 54 IK 10 20J xx9 CE UK CA

LED	W	LM	REAL LM	COL.	CODE *	€	* LED COLOUR
3	360	120	AC DIRECT		LL14302W□	105,00	N 4000K
					LL14302L□	105,00	3 3000K, lm -5%
					LL14302D□	105,00	2 2700K, lm -5%
					LL14302Z□	105,00	

Fasci disponibili: 15°, 30°, 60°, regolabili tramite mascherine sostituibili.

Available light beams: 15°, 30°, 60°, adjustable with removable masks.

Faisceaux disponibles : 15°, 30°, 60°, réglables avec masques amovibles.

## Dodo 100

NEW

DIFF.  
TRASP.

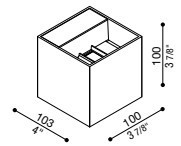

IP 54 IK 10 20J xx9 CE UK CA

LED	W	LM	REAL LM	COL.	CODE *	€	* LED COLOUR
10	1180	350	220-240 V		LL14303W□	119,00	N 4000K
					LL14303L□	119,00	3 3000K, lm -5%
					LL14303D□	119,00	2 2700K, lm -5%
					LL14303Z□	119,00	

Fasci disponibili: 30°, 45°, 60°, 75°, 90°, regolabili tramite alette.

Available light beams: 30°, 45°, 60°, 75°, 90°, adjustable with fins.

Faisceaux disponibles : 30°, 45°, 60°, 75°, 90°, réglables avec ailettes.



## Dodo 100 Full



DIFF. TRASP.

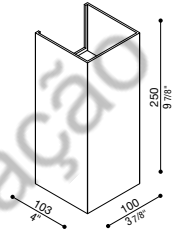

IP 54 IK 10 20J xx9 CE UK CA

LED	W	LM	REAL LM	COL.	CODE *	€	* LED COLOUR
	10	1180	350		LL14304W□	154,00	N 4000K
					LL14304L□	154,00	3 3000K, Im -5%
					LL14304D□	154,00	2 2700K, Im -5%
					LL14304Z□	154,00	

Fasci disponibili: 30°, 45°, 60°, 75°, 90°, regolabili tramite alette.

Available light beams: 30°, 45°, 60°, 75°, 90°, adjustable with fins.

Faisceaux disponibles: 30°, 45°, 60°, 75°, 90°, réglables avec ailettes.

## Dodo 300



DIFF. TRASP.

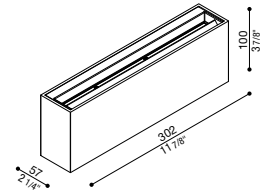

IP 54 IK 10 20J xx9 CE UK CA

LED	W	LM	REAL LM	COL.	CODE *	€	* LED COLOUR
	20	2900	1220		LL14305W□	189,00	N 4000K
					LL14305L□	189,00	3 3000K, Im -5%
					LL14305D□	189,00	2 2700K, Im -5%
					LL14305Z□	189,00	

Possibilità di regolare l'apertura del fascio luminoso.

Adjustable light beam angle.

Possibilité de régler l'angle du faisceau.

### Finishing

	Bianco RAL 9003 White RAL 9003 Blanc RAL 9003		Dark Grey RAL 7021 Dark Grey RAL 7021 Gris Foncé RAL 7021
	Light Grey RAL 7044 Light Grey RAL 7044 Gris Pale RAL 7044		Gold - Dark Grey RAL 7021 Gold - Dark Grey RAL 7021 Gold - Dark Grey RAL 7021

### \* Led colour

- N 4000K
- 3 3000K, Im -5%
- 2 2700K, Im -5%

**Completa il codice**  
sostituendo al quadrato rosso la lettera o il numero corrispondente alla temperatura colore scelta.

**Complete the code**  
by replacing the red box with the letter or number corresponding to the selected colour temperature.

**Compléter le code**  
en remplaçant le carré rouge par la lettre ou le numéro correspondant à la sélection de température couleur.

**Alimentatore integrato**  
Integrated driver  
Alimentation intégrée



# Dodo



Tutti i modelli sono predisposti per la regolazione del fascio di luce.

All models are designed for beam adjustment.

Tous les modèles sont préparés pour le réglage du faisceau.

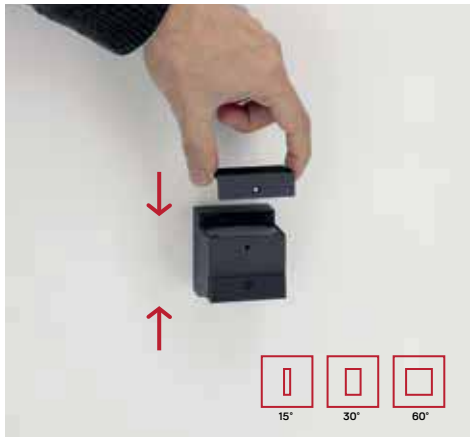

## DODO 60 - DODO 60 FULL

fasci disponibili: 15°, 30°, 60° - mascherine sostituibili.

Available light beams: 15°, 30°, 60° - exchangeable masks.

Faisceaux lumineux disponibles : 15°, 30°, 60° - masques interchangeables.



## DODO 100 - DODO 100 FULL

fasci disponibili: 30°, 45°, 60°, 75°, 90° - alette regolabili.

Available light beams: 30°, 45°, 60°, 75°, 90° - adjustable fins.

Faisceaux lumineux disponibles : 30°, 45°, 60°, 75°, 90° ailettes réglables.



## DODO 300

Fascio luminoso regolabile tramite aletta.

Adjustable light beam by means of flap.

Faisceau lumineux orientable par un volet.

## Colori disponibili.

Available colours.

Couleurs disponibles.





# Dodo





Dodo 60

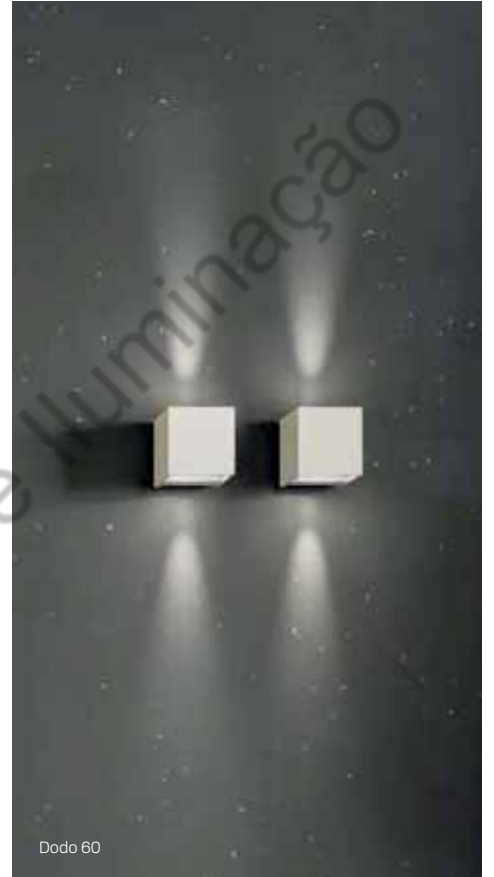

Dodo 60

# Dodo







Dodo 300



Dodo 300

# Tape

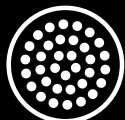

LED



indoor



outdoor

**ACCESSORI**

Accessories / Accessoires

Pag. 330



Adatto anche ad uso esterno. Corpo in alluminio primario pressofuso EN-AB46100; elevata resistenza all'ossidazione grazie al trattamento di cataforesi e alla verniciatura con resine poliesteri stabilizzata ai raggi UV.

Diffusore in vetro temprato effetto satinato.

Staffa in acciaio AISI 316L per il fissaggio a muro o a scatola standard. Provvisto di acqua stop integrato che protegge il prodotto dalle infiltrazioni di acqua e di umidità.

Alimentazione 24V.

Driver esterno al prodotto alloggiabile in scatole da incasso standard 502 / 503 / 504 / 506L.

**LED 4000K (N), 3000K (3) o 2700K (2). Nessun rischio fotobiologico, RG0 gruppo di rischio esente (EN62471).**

**ENG** Also suitable for outdoor use. Die-cast primary aluminium body EN-AB46100; high resistance to oxidation thanks to cathoporesis treatment and painting with polyester resins stabilised against UV rays. Satin-finish toughened glass diffuser. Wall or standard box fixing bracket in AISI 316L steel. Product supplied with water-stop device to protect it from water and humidity infiltration.

Power supply 24V. External driver housed in standard 502 / 503 / 504 / 506L recessed boxes.

**LED 4000K (N), 3000K (3) or 2700K (2). No photobiological risk, RG0 risk group (EN62471).**

**FRA** Convient également à un usage extérieur. Corps en aluminium primaire moulé sous pression EN-AB46100; haute résistance à l'oxydation grâce au traitement par cataphorèse et à la peinture avec des résines polyester stabilisées contre les rayons UV.

Diffuseur en verre trempé satiné. Support en acier AISI 316L pour fixation murale ou sur boîte standard. Dispositif d'arrêt intégré qui protège le produit contre les infiltrations d'eau et d'humidité.

Alimentation électrique 24V. Pilote externe logé dans des boîtiers encastrés standard 502 / 503 / 504 / 506L.

**LED 4000K (N), 3000K (3) ou 2700K (2). Pas de risque photobiologique, groupe de risque RG0 exempt (EN62471).**

**Tape 80**



**Tape 140**



**Tape 220**



**Outdoor  
e waterproof**



**Aquastop**



**Dimmerabile**

Dimmable  
Dimmable



**Cataforesi**  
Cataphoresis  
Cataphorèse



**Anni di garanzia  
sul circuito LED**

Years warranty on LED circuit  
Ans de garantie sur la source LED

# Tape

## Tape 80



DIFF.  
VETRO

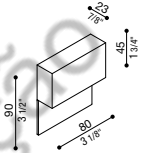

IP 66 IK 06 1J xx3 CE UK CA

LED	W	LM	REAL LM	COL.	CODE *	€	* LED COLOUR
2	290	248	24V		LL14501W□	75,00	N 4000K 3 3000K, lm -5% 2 2700K, lm -5%
					LL14501L□	75,00	
					LL14501D□	75,00	
					LL14501K□	75,00	
					LL14501Z□	75,00	
2	290	248	24V KIT TAPE 80 + DRIVER IP67		LL14511W□	88,00	
					LL14511L□	88,00	
					LL14511D□	88,00	
					LL14511K□	88,00	
					LL14511Z□	88,00	
2	290	248	24V KIT TAPE 80 + DRIVER IP67 + BOX		LL14521W□	95,00	
					LL14521L□	95,00	
					LL14521D□	95,00	
					LL14521K□	95,00	
					LL14521Z□	95,00	

Codici LL14511: kit composti da Tape 80 + LB1070068 (driver IP67)

Codici LL14521: kit composti da Tape 80 + scatola incasso 502 LB1250001 + LB1070068 (driver IP67)

Codes LL14512: Kit consisting of Tape 80 + LB1070068 (driver IP67)

Codes LL14522: Kit consisting of Tape 80 + recess box 502 LB1250001 + LB1070068 (driver IP67)

Codes LL14512: Kit composé des Tape 80 + LB1070068 (driver IP67)

Codes LL14522: Kit composé des Tape 80 + armature à encastrer LB1250001 + LB1070068 (driver IP67)

## Tape 140



DIFF.  
VETRO

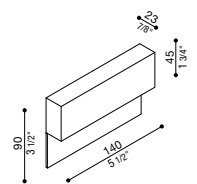

IP 66 IK 06 1J xx3 CE UK CA

LED	W	LM	REAL LM	COL.	CODE *	€	* LED COLOUR
4	590	419	24V		LL14502W□	85,00	N 4000K 3 3000K, lm -5% 2 2700K, lm -5%
					LL14502L□	85,00	
					LL14502D□	85,00	
					LL14502K□	85,00	
					LL14502Z□	85,00	
4	590	419	24V KIT TAPE 140 + DRIVER IP67		LL14512W□	98,00	
					LL14512L□	98,00	
					LL14512D□	98,00	
					LL14512K□	98,00	
					LL14512Z□	98,00	
4	590	419	24V KIT TAPE 140 + DRIVER IP67 + BOX		LL14522W□	101,00	
					LL14522L□	101,00	
					LL14522D□	101,00	
					LL14522K□	101,00	
					LL14522Z□	101,00	

Codici LL14512: kit composti da Tape 140 + LB1070068 (driver IP67)

Codici LL14522: kit composti da Tape 140 + scatola incasso 503 LB11660 + LB1070068 (driver IP67)

Codes LL14512: Kit consisting of Tape 140 + LB1070068 (driver IP67)

Codes LL14522: Kit consisting of Tape 140 + recess box 503 LB11660 + LB1070068 (driver IP67)

Codes LL14512: Kit composé des Tape 140 + LB1070068 (driver IP67)

Codes LL14522: Kit composé des Tape 140 + armature à encastrer 503 LB11660 + LB1070068 (driver IP67)



**Tape 220**



DIFF. VETRO

IP 66 IK 06 1J xx3 CE UK CA

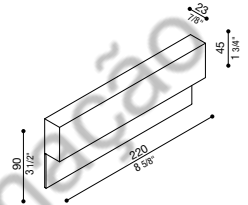

LED	W	LM	REAL LM	COL.	CODE *	€	* LED COLOUR
6	870	800	24V		LL14503W□	95,00	N 4000K 3 3000K, lm -5% 2 2700K, lm -5%
					LL14503L□	95,00	
					LL14503D□	95,00	
					LL14503K□	95,00	
					LL14503Z□	95,00	
6	870	800	24V KIT TAPE 220 + DRIVER IP67		LL14513W□	132,00	
					LL14513L□	132,00	
					LL14513D□	132,00	
					LL14513K□	132,00	
					LL14513Z□	132,00	
6	870	800	24V KIT TAPE 220 + DRIVER IP67 + BOX		LL14523W□	145,00	
					LL14523L□	145,00	
					LL14523D□	145,00	
					LL14523K□	145,00	
					LL14523Z□	145,00	

Codici LL14513: kit composti da Tape 220 + LB1070069 (driver IP67)  
 Codici LL14523: kit composti da Tape 220 + armatura da incasso 506 LB11680 + LB1070069 (driver IP67)

Codes LL14513: Kit consisting of Tape 220 + LB1070069 (driver IP67)  
 Codes LL14523: Kit consisting of Tape 220 + recess box 506 LB11680 + LB1070069 (driver IP67)

Codes LL14513: Kit composé des Tape 220 + LB1070069 (driver IP67)  
 Codes LL14523: Kit composé des Tape 220 + armature à encastrer LB11680 + LB1070069 (driver IP67)

**Finishing**

	Bianco RAL 9003 White RAL 9003 Blanc RAL 9003		Corten Corten Corten
	Light Grey RAL 7044 Light Grey RAL 7044 Gris Pale RAL 7044		Gold Gold Gold
	Dark Grey RAL 7021 Dark Grey RAL 7021 Gris Foncé RAL 7021		

- \* **Led colour**
- N 4000K
  - 3 3000K, lm -5%
  - 2 2700K, lm -5%

**Completa il codice**  
 sostituendo al quadrato rosso la lettera o il numero corrispondente alla temperatura colore scelta.

**Complete the code**  
 by replacing the red box with the letter or number corresponding to the selected colour temperature.

**Compléter le code**  
 en remplaçant le carré rouge par la lettre ou le numéro correspondant à la sélection de température couleur.

- ✓ **Alimentatore incluso da remoto**  
 Remote driver included  
 Alimentation déportée incluse
- ✗ **Alimentatore escluso**  
 Driver not included  
 Alimentation non incluse



# Tape

## ACCESSORI

Accessories / Accessoires

### Scatola incasso standard 502

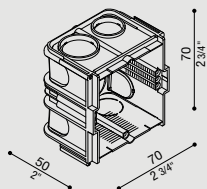

Recess Box 502

Armature à encastrer standard 502

COL.	CODE	€
	LB1250001	7,30

### Scatola Incasso Standard 503

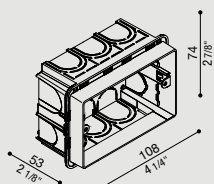

Recess Box 503

Armature à encastrer standard 503

COL.	CODE	€
	LB11660	3,30

### Scatola Incasso Standard 504

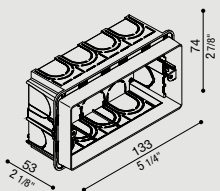

Recess Box 504

Armature à encastrer standard 504

COL.	CODE	€
	LB11690	5,30

### Scatola Incasso Standard 506L

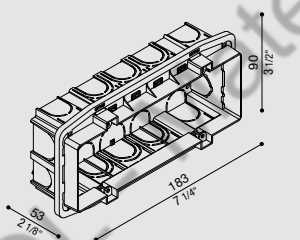

Recess Box 506L

Armature à encastrer standard 506L

COL.	CODE	€
	LB11680	13,50

### Alimentatori 24V in tensione costante

24V constant voltage driver

Alimentations à tension constante de 24V T

Prod	Spec	N° max	IP	Recess box *	CODE	€
Tape 80	On-Off	1/2	20	502	LB1070067	16,50
Tape 80	On-Off	1	67	502	LB1070068	15,50
Tape 80	On-Off	1/12	67	506	LB1070069	40,50
Tape 80	On-Off	1/5	20	503	LB1070070	35,50
Tape 140	On-Off	1	20	502	LB1070067	16,50
Tape 140	On-Off	1	67	502	LB1070068	15,50
Tape 140	On-Off	1/6	67	506	LB1070069	40,50
Tape 140	On-Off	1/2	20	503	LB1070070	35,50
Tape 220	On-Off	1	20	502	LB1070067	16,50
Tape 220	On-Off	1/4	67	506	LB1070069	40,50
Tape 220	On-Off	1	20	503	LB1070070	35,50

\* Il driver ha una dimensione che gli consente di essere alloggiato all'interno delle scatolette indicate (grandezza minima).

The driver is small enough to fit into standard recess boxes indicated (minimum size).  
Le alimentation électrique est suffisamment petit pour s'insérer dans des boîtes d'encastrement standard indiquées (taille minimale).



Colori disponibili.  
 Available colours.  
 Couleurs disponibles.



Tape 80

# Tape



Tape è predisposto per il montaggio su scatole standard (solo nella versione con cover).

Suitable for mounting on recess boxes (only version with cover).

Adapté au montage sur des boîtes d'encastrement (uniquement version avec cover).

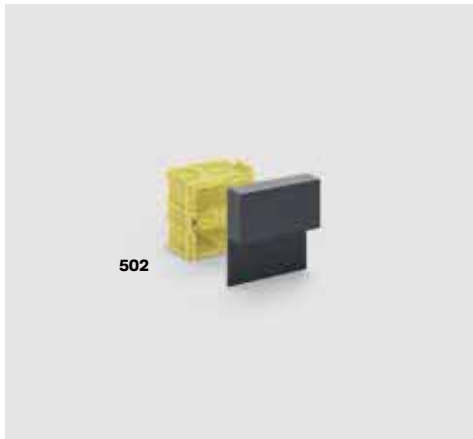

**Tape 80** installabile su scatola standard 502.

Installation on recess box 502.

Pour installation sur boîte standard 502.

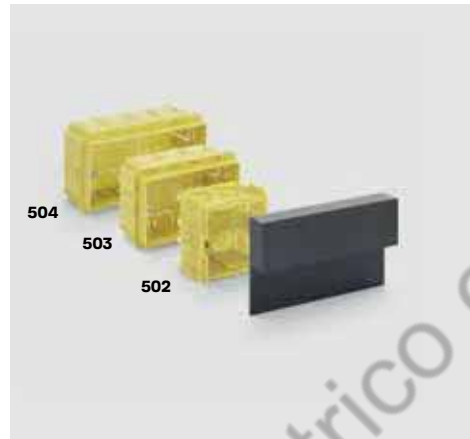

**Tape 140** installabile su scatola standard 502 - 503 - 504.

Installation on recess box 502 - 503 - 504

Pour installation sur boîte standard 502 - 503 - 504



**Tape 220** installabile su scatola standard 503 - 504 - 506L.

Installation on recess box 503 - 504 - 506L

Pour installation sur boîte standard 503 - 504 - 506L

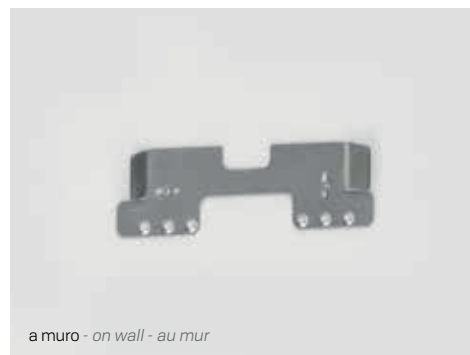
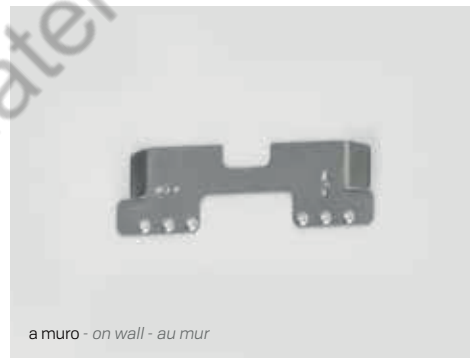

**A** Installabile direttamente a muro o su scatola standard.  
Installation directly on the wall or with standard recess box.  
Installation directement au mur ou avec une boîte d'encastrement standard.

**B** Installabile solo a muro.  
Installation only on wall.  
Installation au mur uniquement.

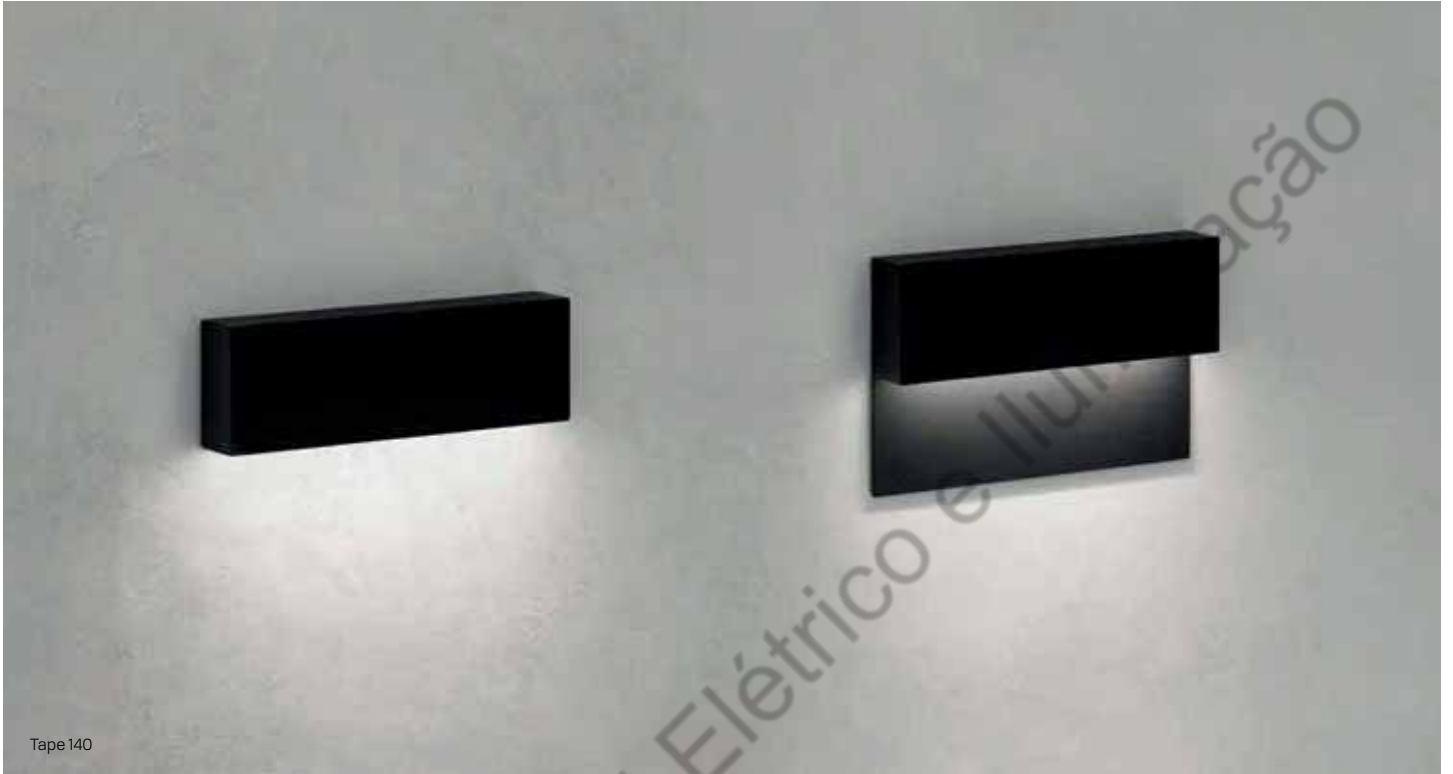

Tape 140



Tape 80

# Tape







# Tape







Tape 220

# Koi



LED



indoor



outdoor

**ACCESSORI**

Accessories / Accessoires

Pag. 340



Adatto anche ad uso esterno. Driver 220-240V integrato e Led di ultima generazione. Corpo e tappo in alluminio primario pressofuso EN-AB46100; elevata resistenza all'ossidazione grazie al trattamento di passivazione a base di zirconio e alla verniciatura con resine poliestere stabilizzata ai raggi UV. Diffusore in vetro temprato effetto satinato. Guarnizione in silicone. Sistema di chiusura tramite viti imperdibili a scomparsa, con cava esagonale. Bulloneria in acciaio A4 o AISI 316L. Predisposto per doppio ingresso alimentazione. **LED 4000K (N), 3000K (3) o 2700K (2). Alimentazione diretta 220-240V. Nessun rischio fotobiologico, RGO gruppo di rischio esente (EN62471).**

**ENG** Suitable for indoor and outdoor use.  
 Integrated driver 220-240V and the latest generation of Led.  
 Body and cover made of EN-AB46100 die-cast aluminium primary alloy; highly resistant to oxidization thanks to the zirconium-based passivation treatment and UV stabilized polyester resin coating.  
 Tempered glass diffuser with frosted effect.  
 Silicone gaskets.  
 Closing system by means of retractable captive hex screws. A4 or AISI 316L stainless steel nuts and bolts. Double cable entry at the back.  
**LED 4000K (N), 3000K (3) or 2700K (2). Integral ballast 220-240V. No risk of photobiological damage, RGO group (EN62471).**

**FRA** Également adapté à l'usage à l'extérieur.  
 Alimentation intégrée 220 - 240V et Led de dernière génération.  
 Corps et couverture en aluminium primaire injecté EN-AB46100; haute résistance à l'oxydation grâce au traitement de passivation à base de zirconium et laquage poudre à base de résines polyesters, fixées au rayon UV. Diffuseur en verre trempé effet satiné. Joints en silicone. Visserie en acier inox type A4 ou AISI 316L. Fermeture vis sans tête à six pans creux. Possibilité alimentation double entrée.  
**LED 4000K (N), 3000K (3) ou 2700K (2) (blanche chaud). Alimentation intégrée 220-240. Pas de risque photobiologique, RGO groupe (EN62471).**

**Koi 110**



**Koi 120**



**Outdoor  
 e waterproof**



**Alimentazione diretta**  
 Direct power supply  
 Alimentation directe

**Koi 220**



**Installazione rapida**  
 Quick installation  
 Installation rapide



**Anni di garanzia  
 sul circuito LED**  
 Years warranty on LED circuit  
 Ans de garantie sur la source LED

Direttamente a parete.  
 Surface mounting.  
 En saillie.

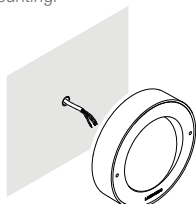

Con scatolette standard.  
 Surface mounting on recess box.  
 En saillie sur boîte d'encastrement.

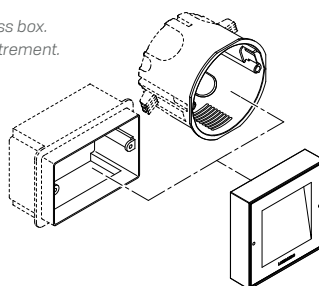

32 mm

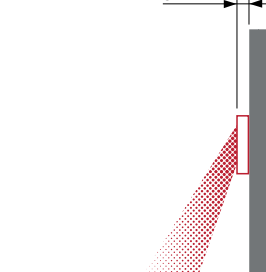



# Koi

## Koi 110

DIFF.  
VETRO

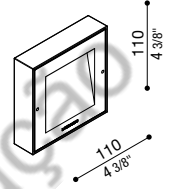

IP 66 IK 10 20J xx9  $\text{CE}$   $\frac{\text{UK}}{\text{CR}}$

LED	W	LM	REAL LM	COL.	CODE *	€	* LED COLOUR
6	750	375	$\oplus$ $\checkmark$ 220-240 V		LL121000□	90,00	N 4000K
					LL121001□	90,00	3 3000K, lm -5%
					LL121002□	90,00	2 2700K, lm -5%
					LL121003□	90,00	

## Koi 120

DIFF.  
VETRO

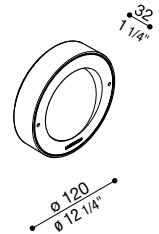

IP 66 IK 10 20J xx9  $\text{CE}$   $\frac{\text{UK}}{\text{CR}}$

LED	W	LM	REAL LM	COL.	CODE *	€	* LED COLOUR
6	750	375	$\oplus$ $\checkmark$ 220-240 V		LL121004□	90,00	N 4000K
					LL121005□	90,00	3 3000K, lm -5%
					LL121006□	90,00	2 2700K, lm -5%
					LL121007□	90,00	

## Koi 220

DIFF.  
VETRO

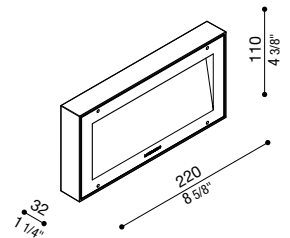

IP 66 IK 10 20J xx9  $\text{CE}$   $\frac{\text{UK}}{\text{CR}}$

LED	W	LM	REAL LM	COL.	CODE *	€	* LED COLOUR
9	1300	650	$\oplus$ $\checkmark$ 220-240 V		LL121008□	126,50	N 4000K
					LL121009□	126,50	3 3000K, lm -5%
					LL121010□	126,50	2 2700K, lm -5%
					LL121011□	126,50	

### Finishing

	Bianco RAL 9010 White RAL 9010 Blanc RAL 9010		Grigio antracite RAL 7021 Grey anthracite RAL 7021 Gris anthracite RAL 7021
	Grigio High Tech RAL 9006 Grey High Tech RAL 9006 Gris High Tech RAL 9006		Corten Corten Corten

### \* Led colour

- N 4000K
- 3 3000K, lm -5%
- 2 2700K, lm -5%

### Completa il codice

sostituendo al quadrato rosso la lettera o il numero corrispondente alla temperatura colore scelta.

### Complete the code

by replacing the red box with the letter or number corresponding to the selected colour temperature.

### Compléter le code

en remplaçant le carré rouge par la lettre ou le numéro correspondant à la sélection de température couleur.

$\checkmark$  Alimentatore integrato  
Integrated driver  
Alimentation intégrée

### Scatola Incasso Standard 503

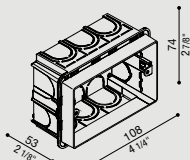

Recess Box 503

Armature à encastrer standard 503

COL.	CODE	€
	LB11660	3,00

### ACCESSORI

Accessories / Accessoires



Colori disponibili.  
Available colours.  
Couleurs disponibles.



Koi 220

# Koi



Koi 220



Koi 120



Koi 110



Koi 120



Koi 220



# Koi Post



LED



outdoor





Adatto anche ad uso esterno.

Driver 220-240V integrato e Led di ultima generazione.

Corpo e tappo in alluminio pressofuso; elevata resistenza all'ossidazione grazie al trattamento di passivazione a base di zirconio e alla verniciatura con resine poliestere stabilizzata ai raggi UV.

Diffusore in vetro temprato effetto satinato.

Guarnizione in silicone. Sistema di chiusura tramite viti imperdibili a scomparsa, con cava esagonale.

Bulloneria in acciaio A4 o AISI 316L. Predisposto per doppio ingresso alimentazione.

Palo da giardino. Corpo realizzato in metallo zincato a freddo, elevata resistenza all'ossidazione grazie al trattamento di cataforesi e alla verniciatura con resine poliestere stabilizzata ai raggi UV. Bulloneria in acciaio inox A4. Idoneo per installazione a terra. Trattamento di cataforesi.

**LED 4000K (N), 3000K (3) o 2700K (2). Alimentazione diretta 220-240V.**

**Nessun rischio fotobiologico, RGO gruppo di rischio esente (EN62471).**

**ENG** Suitable for indoor and outdoor use.

Integrated driver 220-240V and the latest generation of Led.

Body and cover made of die-cast aluminium primary alloy; highly resistant to oxidation thanks to the zirconium-based passivation treatment and UV stabilized polyester resin coating.

Tempered glass diffuser with frosted effect.

Silicone gaskets.

A4 or AISI 316L stainless steel nuts and bolts.

Closing system by means of retractable captive hex screws. Double cable entry at the back.

Post for garden use. Made of cold galvanized metal, highly resistant to oxidation due to cathoporesis treatment and UV stabilized polyester resin coating. A4 stainless steel nuts and bolts. Suitable for outdoor use and ground application.

**LED 4000K (N), 3000K (3) or 2700K (2). Integral ballast 220-240V.**

**No risk of photobiological damage, RGO group (EN62471).**

**FRA** Également adapté à l'usage à l'extérieur.

Alimentation intégrée 220 - 240V et Led de dernière génération.

Corps et couverture en aluminium primaire injecté; haute résistance à l'oxydation grâce au traitement de passivation à base de zirconium et laquage poudre à base de résines polyesters, fixées au rayon UV.

Diffuseur en verre trempé effet satiné.

Joint en silicone.

Visserie en acier inox type A4 ou AISI 316L.

Fermeture vis sans tête à six pans creux. Possibilité alimentation double entrée. Poteau de jardin. Corps réalisé en métal zingué à froid, haute

résistance à l'oxydation grâce au traitement de cathoporesis et laquage poudre à base de résines polyesters, fixées aux rayons UV. Boulonnerie en acier inox A4. Convient pour une utilisation au sol.

**LED 4000K (N), 3000K (3) ou 2700K (2) (blanche chaud).**

**Alimentation intégrée 220-240. Pas de risque photobiologique, RGO groupe (EN62471).**

**Koi 110 Post H400**



**Koi 110 Post H600**



**Outdoor  
e waterproof**



**Alimentazione diretta**

Direct power supply  
Alimentation directe

**Koi 220 Post H600**



**Cataforesi**

Cataphoresis  
Cataphorèse



**Anni di garanzia  
sul circuito LED**









Years warranty on LED circuit  
Ans de garantie sur la source LED

# Koi Post

## Koi 110 Post H400

DIFF.  
VETRO

IP66 IK 10 20J xx9   

LED	W	LM	REAL LM	COL.	CODE *	€	* LED COLOUR
6	750	375	  220-240 V		LL121016□	193,00	 4000K
					LL121017□	193,00	 3000K, Im -5%
					LL121018□	193,00	 2700K, Im -5%
					LL121019□	193,00	

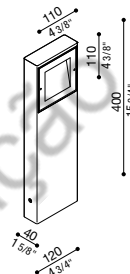

Composto da Koi 110 + Palo H 400 mm





Consisting of Koi 110 + Post H 400 mm.

Composé de Koi 110 + Poteau 400 mm.

## Koi 110 Post H600

DIFF.  
VETRO

IP66 IK 10 20J xx9   

LED	W	LM	REAL LM	COL.	CODE *	€	* LED COLOUR
6	750	375	  220-240 V		LL121012□	216,50	 4000K
					LL121013□	216,50	 3000K, Im -5%
					LL121014□	216,50	 2700K, Im -5%
					LL121015□	216,50	

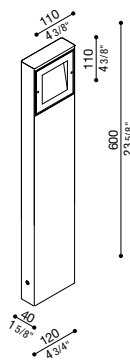

Composto da Koi 110 + Palo H 600 mm.









Consisting of Koi 110 + Post H 600 mm.

Composé de Koi 110 + Poteau 600 mm.

## Koi 220 Post H600

DIFF.  
VETRO

IP66 IK 10 20J xx9   

LED	W	LM	REAL LM	COL.	CODE *	€	* LED COLOUR
9	1300	650	  220-240 V		LL121030□	330,00	 4000K
					LL121031□	330,00	 3000K, Im -5%
					LL121032□	330,00	 2700K, Im -5%
					LL121033□	330,00	

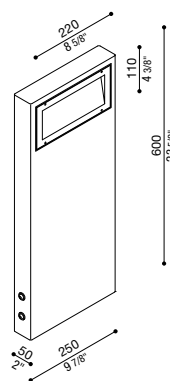





Composto da Koi 220 + Palo H 600 mm.



Consisting of Koi 220 + Post H 600 mm.

Composé de Koi 220 + Poteau 600 mm.

### Finishing

	Bianco RAL 9010 White RAL 9010 Blanc RAL 9010		Grigio antracite RAL 7021 Grey anthracite RAL 7021 Gris anthracite RAL 7021
	Grigio High Tech RAL 9006 Grey High Tech RAL 9006 Gris High Tech RAL 9006		Corten Corten Corten

### \* Led colour

-  4000K
-  3000K, Im -5%
-  2700K, Im -5%

**Completa il codice**  
sostituendo al quadrato rosso la lettera o il numero corrispondente alla temperatura colore scelta.

**Complete the code**  
by replacing the red box with the letter or number corresponding to the selected colour temperature.

**Compléter le code**  
en remplaçant le carré rouge par la lettre ou le numéro correspondant à la sélection de température couleur.

### Alimentatore integrato Integrated driver Alimentation intégrée



Koi 110 post H400

Iluminação



Koi 110 post H400

# Trend

**220**

**Trend 220**



**Trend Up&Down 220**



**110**

**Trend 110**



**Trend Up&Down 110**

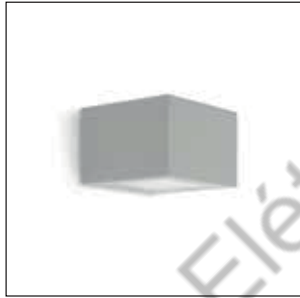

**Trend Up&Down 110 Blade**

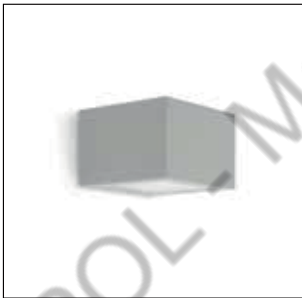

**Trend Top 110**

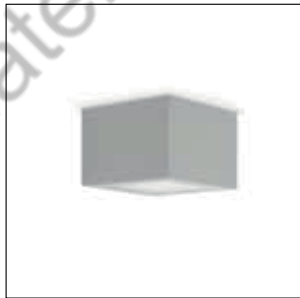

SAPOL - Material Eléctrico e Iluminação



**60**

**Trend 60**



**Trend 60 Blade**



**Trend U&D 60**



**Trend U&D 60 Blade**



**Trend U&D 60 Doppio Blade**



**60  
Post**

**Trend 60 Post H600**



**Trend 60 Post H800**



SAPOL - Material Elettrico e Illuminazione



# Trend

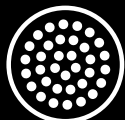

LED



indoor



outdoor

**ACCESSORI**

Accessories / Accessoires

Pag. 355



Adatto anche ad uso esterno.

Corpo, anelli e tappo in alluminio pressofuso; elevata resistenza all'ossidazione grazie al trattamento di passivazione a base di zirconio e alla verniciatura con resine poliestere stabilizzata ai raggi UV. Diffusore in policarbonato tripla stabilizzazione UV. Guarnizioni in silicone. Riflettore in alluminio tipo L2-1060. Bulloneria in acciaio inox A4. Sistema di chiusura tramite viti imperdibili a scomparsa, con cava esagonale ch. 2,5.

**LED 4000K (N) o 3000K (3). Alimentazione diretta 220-240V.**

**Nessun rischio fotobiologico, RGO gruppo di rischio esente (EN62471).**

**ENG** Suitable for indoor and outdoor use.

Die-cast aluminium body, rings and cap; highly resistant to oxidization thanks to the zirconium-based passivation treatment and UV stabilized polyester resin coating. Polycarbonate diffuser with triple UV stabilisation. Silicone gaskets. Reflector made of aluminium type L2-1060. A4 stainless steel nuts and bolts.

Closing system by means of retractable captive hex screws size 2,5 mm.

**LED 4000K (N) or 3000K (3). Integral ballast 220-240V.**

**No risk of photobiological damage, RGO group (EN62471).**

**FRA** Également adapté à l'usage à l'extérieur.

Corps, anneaux et bouchon en aluminium injecté; haute résistance à l'oxydation, grâce à un traitement de passivation à base de zirconium et laquage poudre à base de résines polyesters, fixées aux rayons UV.

Diffuseur en polycarbonate à triple stabilisation UV. Joints en silicone.

Réflecteur en aluminium type L2-1060. Fixation en acier inox type A4.

Fermeture vis sans tête à six pans creux ch. 2,5.

**LED 4000K (N) ou 3000K (3) (blanche chaud). Alimentation intégrée 220-240.**

**Pas de risque photobiologique, RGO groupe (EN62471).**

**Trend 220**



**Trend Up&Down 220**



**Outdoor  
e waterproof**

**Trend 110**



**Trend Up&Down 110**



**Anni di garanzia  
sul circuito LED**

Years warranty on LED circuit  
Ans de garantie sur la source LED

**Trend Up&Down 110 Blade**



**Trend Top 110**



# Trend

## Trend 220



DIFF. POLIGLASS

DIFF. TRASP.

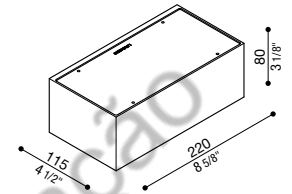

IP66 IK10 20J xx9 CE UK CA

LED	W	LM	REAL LM	COL.	CODE **	CODE **	€	* OPTIC	* LED COLOUR
18	2450	1470-2250	⊕	✓ 220-240 V	LL490000□	LL490004□	174,00	S 8° M 11° L 30°	N 4000K 3 3000K, lm -5% 2 2700K, lm -5%
					LL490001□	LL490005□	174,00		
					LL490002□	LL490006□	174,00		
					LL490003□	LL490007□	174,00		
15	1900	1170-1875	⊕	✓ 220-240 V	LL4911□	LL4941□	148,00		
					LL491G□	LL494G□	148,00		
					LL491E□	LL494E□	148,00		
					LL491K□	LL494K□	148,00		
8	860	743	⊕	✓ 220-240 V		LL4931□□	217,50		
						LL493G□□	217,50		
						LL493E□□	217,50		
						LL493K□□	217,50		
LAMP	ATT. E27	LAMP MAX 1x20	⊕		LB49121	LB49421	116,00		
					LB4912G	LB4942G	116,00		
					LB4912E	LB4942E	116,00		
					LB4912K	LB4942K	116,00		

Versione Monoemissione.  
Lampade dim. max: E27 128 mm Ø 48 mm

Unidirectional version.  
Lamp max. dim.: E27 128 mm Ø 48 mm.

Version unidirectionnelle.  
Lampes dim. max: E27 128 mm Ø 48 mm.

## Trend Up&Down 220



DIFF. POLIGLASS

DIFF. TRASP.

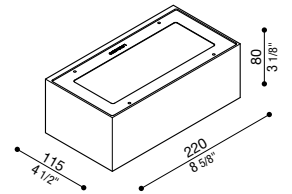

IP66 IK10 20J xx9 CE UK CA

LED	W	LM	REAL LM	COL.	CODE **	CODE **	€	* OPTIC	* LED COLOUR
24	3600	2160-3310	⊕	✓ 220-240 V	LL490008□	LL490012□	226,50	S 8° M 11° L 30°	N 4000K 3 3000K, lm -5% 2 2700K, lm -5%
					LL490009□	LL490013□	226,50		
					LL490010□	LL490014□	226,50		
					LL490011□	LL490015□	226,50		
15	2200	1260-2060	⊕	✓ 220-240 V	LL4921□	LL4951□	183,50		
					LL492G□	LL495G□	183,50		
					LL492E□	LL495E□	183,50		
					LL492K□	LL495K□	183,50		
11	1400	1078	⊕	✓ 220-240 V		LL4961□□	299,50		
						LL496G□□	299,50		
						LL496E□□	299,50		
						LL496K□□	299,50		
LAMP	ATT. E27	LAMP MAX 1x20	⊕		LB49221	LB49521	116,00		
					LB4922G	LB4952G	116,00		
					LB4922E	LB4952E	116,00		
					LB4922K	LB4952K	116,00		

Versione Biemissione.  
Lampade dim. max: E27 128 mm Ø 48 mm.

Bidirectional version.  
Lamp max. dim.: E27 128 mm Ø 48 mm.

Version bidirectionnelle.  
Lampes dim. max: E27 128 mm Ø 48 mm.



### Trend 110

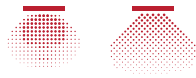

DIFF. POLIGLASS

DIFF. TRASP.

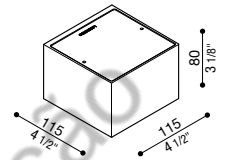

IP66 IK 10 20J xx9 CE UK CRA

LED	W	LM	REAL LM	COL.	CODE **	CODE **	€	* OPTIC	* LED COLOUR
4	402	209 - 247	220-240 V	[Symbol]	LL108000□	LL108004□	111,00	S 17°	N 4000K
					LL108001□	LL108005□	111,00	M 24°	3 3000K, Im -5%
					LL108003□	LL108007□	111,00	L 36°	2 2700K, Im -5%
					LL108002□	LL108006□	111,00		
7	752	308 - 526	220-240 V	[Symbol]	LL108065□	LL108069□	119,00		
					LL108066□	LL108070□	119,00		
					LL108067□	LL108071□	119,00		
					LL108068□	LL108072□	119,00		
7	752	571	220-240 V	[Symbol]		LL108073□	134,50		
						LL108074□	134,50		
						LL108075□	134,50		
						LL108076□	134,50		

Versione Monoemissione.

Unidirectional version.

Version unidirectionnelle.

### Trend Up&Down 110



DIFF. POLIGLASS

DIFF. TRASP.

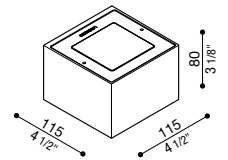

IP66 IK 10 20J xx9 CE UK CRA

LED	W	LM	REAL LM	COL.	CODE **	CODE **	€	* OPTIC	* LED COLOUR
7	752	418 - 496	220-240 V	[Symbol]	LL108008□	LL108012□	147,00	S 17°	N 4000K
					LL108009□	LL108013□	147,00	M 24°	3 3000K, Im -5%
					LL108011□	LL108015□	147,00	L 36°	2 2700K, Im -5%
					LL108010□	LL108014□	147,00		
7	752	665	220-240 V	[Symbol]		LL108020□	161,50		
						LL108021□	161,50		
						LL108023□	161,50		
						LL108022□	161,50		

Versione biemissione.

Bidirectional version.

Version bidirectionnelle.

#### Finishing

	Bianco RAL 9010 White RAL 9010 Blanc RAL 9010		Grigio antracite RAL 7021 Grey anthracite RAL 7021 Gris anthracite RAL 7021
	Grigio High Tech RAL 9006 Grey High Tech RAL 9006 Gris High Tech RAL 9006		Corten Corten Corten

✓ Alimentatore integrato  
Integrated driver  
Alimentation intégrée

#### \* Optic



Completa il codice sostituendo al quadrato grigio la lettera corrispondente al modello di ottica scelta.

Complete the code by replacing the grey box with the letter corresponding to the selected optic model.

Compléter le code en remplaçant le carré gris par la lettre correspondante au modèle de lentille choisie.

# Trend

## Trend Up&Down 110 Blade

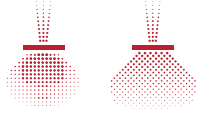

DIFF.  
POLIGLASS

DIFF.  
TRASP.

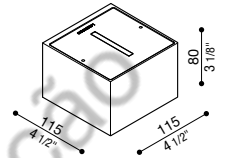

IP66 IK 10 20J xx9 CE UK  
CA

LED	W	LM	REAL LM	COL.	CODE *	CODE *	€	* LED COLOUR
	7	752	208 - 310	⊕ 220-240 V	LL108062□	LL108024□	147,00	N 4000K
					LL108061□	LL108025□	147,00	3 3000K, lm -5%
					LL108063□	LL108027□	147,00	2 2700K, lm -5%
					LL108064□	LL108026□	147,00	

## Trend Top 110



DIFF.  
POLIGLASS

DIFF.  
TRASP.

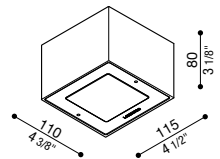

IP66 IK 10 20J xx9 CE UK  
CA

LED	W	LM	REAL LM	COL.	CODE **	CODE **	€	* OPTIC	* LED COLOUR
	4	402	209 - 247	⊕ 220-240 V	LL108032□	LL108036□	111,00	S 17°	N 4000K
					LL108033□	LL108037□	111,00	M 24°	3 3000K, lm -5%
					LL108034□	LL108038□	111,00	L 36°	2 2700K, lm -5%
					LL108035□	LL108039□	111,00		
	7	752	308 - 526	⊕ 220-240 V	LL108049□	LL108053□	119,00		
					LL108050□	LL108054□	119,00		
					LL108051□	LL108055□	119,00		
					LL108052□	LL108056□	119,00		
	7	752	571	⊕ 220-240 V		LL108057□	134,50		
						LL108058□	134,50		
						LL108059□	134,50		
						LL108060□	134,50		

Versione per installazione a soffitto.

Ceiling application.

Installation au plafond.

### Finishing

	Bianco RAL 9010 White RAL 9010 Blanc RAL 9010		Grigio antracite RAL 7021 Grey anthracite RAL 7021 Gris anthracite RAL 7021
	Grigio High Tech RAL 9006 Grey High Tech RAL 9006 Gris High Tech RAL 9006		Corten Corten Corten

✓ Alimentatore integrato  
Integrated driver  
Alimentation intégrée

### \* Led colour

- N 4000K
- 3 3000K, lm -5%
- 2 2700K, lm -5%

**Completa il codice**  
sostituendo al quadrato rosso la lettera o il numero corrispondente alla temperatura colore scelta.

**Complete the code**  
by replacing the red box with the letter or number corresponding to the selected colour temperature.

**Compléter le code**  
en remplaçant le carré rouge par la lettre ou le numéro correspondant à la sélection de température couleur.





**ACCESSORI**

Accessories / Accessoires

**Still**

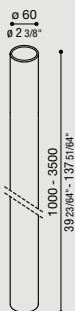

Palo diametro 60 mm in Bayblend senza basamento.  
Possibilità di installazione con o senza basamento. Anima interno palo in acciaio zincato per altezze da 2000 mm.

**Still**  
60 mm Bayblend pole without base.  
Possibility of installation with or without base.  
Galvanized steel inner pole from H 2000 mm.

**Still**  
Poteau de 60 mm en Bayblend sans socle.  
Possibilité d'installation avec ou sans socle. Noyau interne en acier galvanisé pour poteau à partir de h. 2000 mm.

H 160 mm			H 1000 mm			H 2000 mm			H 3000 mm		
COL.	CODE	€	COL.	CODE	€	COL.	CODE	€	COL.	CODE	€
	LB11033	10,50		LB1100012	13,00		LB1100032	36,50		LB1100052	52,00
	LB1103G	34,50		LB110001G	42,50		LB110003G	92,00		LB110005G	135,00
	LB1103E	34,50		LB110001E	42,50		LB110003E	92,00		LB110005E	135,00
	LB1103K	34,50		LB110001K	42,50		LB110003K	92,00		LB110005K	135,00
	LB11031	34,50		LB110001W	42,50		LB1100031	92,00		LB1100051	135,00

H 500 mm			H 1500 mm			H 2500 mm			H 3500 mm		
COL.	CODE	€	COL.	CODE	€	COL.	CODE	€	COL.	CODE	€
	LB11112	12,00		LB1100022	20,00		LB1100042	47,00		LB1100062	62,50
	LB1111G	38,50		LB110002G	63,50		LB110004G	114,00		LB110006G	156,50
	LB1111E	38,50		LB110002E	63,50		LB110004E	114,00		LB110006E	156,50
	LB1111K	38,50		LB110002K	63,50		LB110004K	114,00		LB110006K	156,50
	LB11111	38,50		LB1100021	63,50		LB1100041	114,00		LB1100061	156,50

**Basamento Palo Still Ø170 mm**

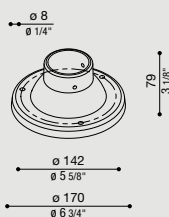

Basamento in nylon-fibra di vetro per palo diametro 60 mm.

**Base Ø170 mm for Still post**  
Base in fibreglass-nylon for post diameter 60 mm.

**Socle Ø170 mm pour poteau Still**  
Socles en fibre de verre - nylon pour poteau diam.60 mm

COL.	CODE	€
	LB11812	22,00
	LB1181G	34,00
	LB1181E	34,00
	LB1181K	34,00
	LB11811	34,00

**Piastra base a scomparsa palo Still**

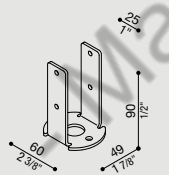

Soluzione alternativa al tradizionale interrimento o al basamento palo still mediante staffa di fissaggio a scomparsa. Consiste nell'inserire il palo still sulla staffa preforata da 3mm, realizzata in ferro zincato a caldo per immersione. Accessorio non idoneo per pali still superiori a h. 1500.

**Retractable plate base**  
Alternative solution to the usual burial or to the post base using a retractable fixing bracket. The post is inserted in the 3mm pre-drilled bracket made of hot-dip zinc-coated metal. Accessory not suitable for posts higher than 1500mm.

**Plaque de base rétractable**  
Solution alternative à l'enfouissement traditionnel ou mise en place moyennant un étrier de fixation rétractable du pieu post. Insérer le poteau Still sur l'étrier pré-percé de 3 mm, réalisé en fer galvanisé à chaud par immersion. Accessoire ne convenant pas à des poteaux Still de plus de 1500mm de haut.

COL.	CODE	€
	LB1130006	14,00

**Dima e kit di fissaggio Palo Still**

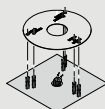

Dima, tirafondi e minuteria per ancoraggio del basamento al terreno.

**Template and fixing kit Still Post diam. 60 mm.**  
Template, fixing bolts and small metal parts to secure the base to the ground.

**Gabarit, tire-fond et visserie pour poteau Still**  
Gabarit, tire-fond et visserie pour l'ancrage du socle au sol.

COL.	CODE	€
	LB11254	13,00

**Braccetto Trend 110**

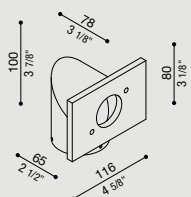

Braccetto Trend 110. Adatto per uso esterno, idoneo per installazione su palo da Ø 60mm. Struttura Braccetto realizzata in metallo zincato a freddo con elevata resistenza all'ossidazione, verniciato con resine di poliestere stabilizzate ai raggi UV. Bulloneria in acciaio inox A4.

**Bracket Trend 110**  
Suitable for outdoor use and for application on a post Ø 60mm. The bracket is made of cold galvanized metal with a high level resistance to oxidization thanks to a UV stabilized polyester resin coating. A4 stainless steel nuts and bolts.

**Bras Trend 110**  
Convient pour une installation en extérieur. Montage sur poteau dia. 60 mm. Bras réalisé en métal zingué à froid, très haute résistance à l'oxydation et laquage poudre à base de résines polyesters, fixées aux rayons UV. Visserie en acier inox A4.

COL.	CODE	€
	LB1080001	69,00
	LB1080002	69,00
	LB1080003	69,00
	LB1080004	69,00



# Trend





Trend 110 Up&Down



# Trend





Trend Up&Down 110 Blade

Webb & Brown Neaves



Trend Top 110



# Trend 60

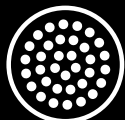

LED



indoor



outdoor

**ACCESSORI**

Accessories / Accessoires

Pag. 364



Adatto anche ad uso esterno.

Corpo in alluminio pressofuso; elevata resistenza all'ossidazione grazie al trattamento di cataforesi e alla verniciatura con resine poliestere stabilizzata ai raggi UV.

Diffusore in vetro temprato e serigrafato.

Guarnizioni in silicone.

Riflettore in alluminio anodizzato.

Bulloneria in acciaio inox A4.

**LED 4000K (N), 3000K (3) o 2700K (2). Alimentazione diretta 220-240V. Nessun rischio fotobiologico, RGO gruppo di rischio esente (EN62471).**

**ENG** Suitable for indoor and outdoor use.

Die-cast aluminium body; highly resistant to oxidization due to cataphoresis treatment and UV stabilized polyester resin coating.

Heat tempered and silk-screen printed glass diffuser.

Silicone gaskets.

Reflector made of anodized aluminium.

A4 stainless steel nuts and bolts.

**LED 4000K (N), 3000K (3) or 2700K (2). Integral ballast 220-240V. No risk of photobiological damage, RGO group (EN62471).**

**FRA** Également adapté pour l'usage à l'extérieur.

Corps en aluminium injecté; haute résistance à l'oxydation grâce au traitement de cataphorèse et laquage poudre à base de résines polyesters, fixées aux rayons UV.

Diffuseur en verre trempé et sérigraphié.

Jointes en silicone.

Réflecteur en aluminium anodisé.

Visserie en acier inox type A4.

**LED 4000K (N), 3000K (3) ou 2700K (2). Alimentation intégrée 220-240V. Pas de risque photobiologique, RGO groupe (EN62471).**



**Outdoor  
e waterproof**



**Alimentazione diretta**  
Direct power supply  
Alimentation directe

**Trend 60**



**Cataforesi**  
Cataphoresis  
Cataphorèse



**Anni di garanzia  
sul circuito LED**  
Years warranty on LED circuit  
Ans de garantie sur la source LED

**Trend 60 Blade**



**Trend U&D 60**



**Trend U&D 60 Blade**



**Trend U&D 60 Doppio  
Blade**



# Trend 60

<b>Trend 60</b>			<b>DIFF. DIFF.</b>	<b>DIFF. TRASP.</b>				
<b>IP 66 IK 07 2J xx5</b>								
LED	W	LM	REAL LM	COL.	CODE *	CODE *	€	* LED COLOUR
3	500	250-260	220-240 V		LL129000□	LL129004□	92,00	N 4000K
					LL129001□	LL129005□	92,00	3 3000K, lm -5%
					LL129002□	LL129006□	92,00	2 2700K, lm -5%
					LL129003□	LL129007□	92,00	
6	1000	440-500	220-240 V		LL129012□	LL129016□	116,00	
					LL129013□	LL129017□	116,00	
					LL129014□	LL129018□	116,00	
					LL129015□	LL129019□	116,00	

Versione monoemissione.

Unidirectional version.

Version unidirectionnelle.

<b>Trend 60 Blade</b>			<b>DIFF. TRASP.</b>				
<b>IP 66 IK 07 2J xx5</b>							
LED	W	LM	REAL LM	COL.	CODE *	€	* LED COLOUR
3	500	20	220-240 V		LL129008□	92,00	N 4000K
					LL129009□	92,00	3 3000K, lm -5%
					LL129010□	92,00	2 2700K, lm -5%
					LL129011□	92,00	

Versione monoemissione.

Unidirectional version.

Version unidirectionnelle.

<b>Trend U&amp;D 60</b>			<b>DIFF. DIFF.</b>	<b>DIFF. TRASP.</b>				
<b>IP 66 IK 07 2J xx5</b>								
LED	W	LM	REAL LM	COL.	CODE *	CODE *	€	* LED COLOUR
6	1000	500-520	220-240 V		LL129100□	LL129104□	116,00	N 4000K
					LL129101□	LL129105□	116,00	3 3000K, lm -5%
					LL129102□	LL129106□	116,00	2 2700K, lm -5%
					LL129103□	LL129107□	116,00	

Versione biemissione.

Bidirectional version.

Version bidirectionnelle.



**Trend U&D 60 Blade**

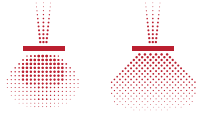

DIFF. DIFF.

DIFF. TRASP.

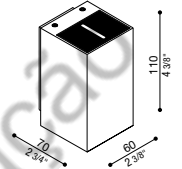

IP66 IK 07 2J xx5 CE UK CA

LED	W	LM	REAL LM	COL.	CODE *	CODE *	€	* LED COLOUR
6	1000	270-280	220-240 V		LL129108□	LL129112□	116,00	N 4000K
					LL129109□	LL129113□	116,00	3 3000K, lm -5%
					LL129110□	LL129114□	116,00	2 2700K, lm -5%
					LL129111□	LL129115□	116,00	

Versione biemissione.

Bidirectional version.

Version bidirectionnelle.

**Trend U&D 60 Doppio Blade**



DIFF. TRASP.

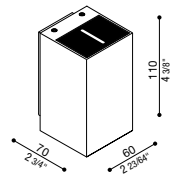

IP66 IK 07 2J xx5 CE UK CA

LED	W	LM	REAL LM	COL.	CODE *	€	* LED COLOUR
6	1000	40	220-240 V		LL129116□	116,00	N 4000K
					LL129117□	116,00	3 3000K, lm -5%
					LL129118□	116,00	2 2700K, lm -5%
					LL129119□	116,00	

Versione biemissione.

Bidirectional version.

Version bidirectionnelle.

**Finishing**

	Bianco RAL 9010 White RAL 9010 Blanc RAL 9010		Grigio antracite RAL 7021 Grey anthracite RAL 7021 Gris anthracite RAL 7021
	Grigio High Tech RAL 9006 Grey High Tech RAL 9006 Gris High Tech RAL 9006		Corten Corten Corten

- \* **Led colour**
- N 4000K
- 3 3000K, lm -5%
- 2 2700K, lm -5%

**Completa il codice**  
sostituendo al quadrato rosso la lettera o il numero corrispondente alla temperatura colore scelta.

**Complete the code**  
by replacing the red box with the letter or number corresponding to the selected colour temperature.

**Compléter le code**  
en remplaçant le carré rouge par la lettre ou le numéro correspondant à la sélection de température couleur.

**Alimentatore integrato**  
Integrated driver  
Alimentation intégrée

# Trend 60

## ACCESSORI

Accessories / Accessoires

### Still

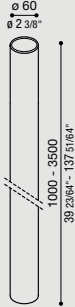

Palo diametro 60 mm in Bayblend senza basamento.  
Possibilità di installazione con o senza basamento. Anima interno palo in acciaio zincato per altezze da 2000 mm.

**Still**  
60 mm Bayblend pole without base.  
Possibility of installation with or without base.  
Galvanized steel inner pole from H 2000 mm.

**Still**  
Poteau de 60 mm en Bayblend sans socle.  
Possibilité d'installation avec ou sans socle. Noyau interne en acier galvanisé pour poteau à partir de h. 2000 mm.

#### H 160 mm

COL.	CODE	€
Black	LB11033	10,50
Grey	LB1103G	34,50
Dark Grey	LB1103E	34,50
Brown	LB1103K	34,50
White	LB11031	34,50

#### H 1000 mm

COL.	CODE	€
Black	LB1100012	13,00
Grey	LB110001G	42,50
Dark Grey	LB110001E	42,50
Brown	LB110001K	42,50
White	LB110001W	42,50

#### H 2000 mm

COL.	CODE	€
Black	LB1100032	36,50
Grey	LB110003G	92,00
Dark Grey	LB110003E	92,00
Brown	LB110003K	92,00
White	LB1100031	92,00

#### H 3000 mm

COL.	CODE	€
Black	LB1100052	52,00
Grey	LB110005G	135,00
Dark Grey	LB110005E	135,00
Brown	LB110005K	135,00
White	LB1100051	135,00

#### H 500 mm

COL.	CODE	€
Black	LB11112	12,00
Grey	LB1111G	38,50
Dark Grey	LB1111E	38,50
Brown	LB1111K	38,50
White	LB11111	38,50

#### H 1500 mm

COL.	CODE	€
Black	LB1100022	20,00
Grey	LB110002G	63,50
Dark Grey	LB110002E	63,50
Brown	LB110002K	63,50
White	LB1100021	63,50

#### H 2500 mm

COL.	CODE	€
Black	LB1100042	47,00
Grey	LB110004G	114,00
Dark Grey	LB110004E	114,00
Brown	LB110004K	114,00
White	LB1100041	114,00

#### H 3500 mm

COL.	CODE	€
Black	LB1100062	62,50
Grey	LB110006G	156,50
Dark Grey	LB110006E	156,50
Brown	LB110006K	156,50
White	LB1100061	156,50

### Basamento Palo Still Ø170 mm

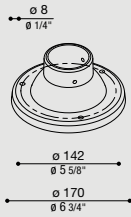

Basamento in nylon-fibra di vetro per palo diametro 60 mm.

**Base Ø170 mm for Still post**  
Base in fibreglass-nylon for post diameter 60 mm.

**Socle Ø170 mm pour poteau Still**  
Soclés en fibre de verre - nylon pour poteau diam.60 mm

COL.	CODE	€
Black	LB11812	22,00
Grey	LB1181G	34,00
Dark Grey	LB1181E	34,00
Brown	LB1181K	34,00
White	LB11811	34,00

### Piastra base a scomparsa palo Still

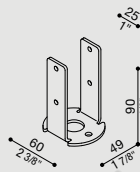

Soluzione alternativa al tradizionale interrimento o al basamento palo still mediante staffa di fissaggio a scomparsa. Consiste nell'inserire il palo still sulla staffa preforata da 3mm, realizzata in ferro zincato a caldo per immersione. Accessorio non idoneo per pali still superiori a h. 1500.

**Retractable plate base**  
Alternative solution to the usual burial or to the post base using a retractable fixing bracket.  
The post is inserted in the 3mm pre-drilled bracket made of hot-dip zinc-coated metal.  
Accessory not suitable for posts higher than 1500mm.

**Plaque de base rétractable**  
Solution alternative à l'enfouissement traditionnel ou mise en place moyennant un étrier de fixation rétractable du pôle post.  
Insérer le poteau Still sur l'étrier pré-percé de 3 mm, réalisé en fer galvanisé à chaud par immersion.  
Accessoire ne convenant pas à des poteaux Still de plus de 1500mm de haut.

COL.	CODE	€
Black	LB1130006	14,00

### Dima e kit di fissaggio Palo Still

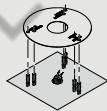

Dima, tirafondi e minuteria per ancoraggio del basamento al terreno.

**Template and fixing kit Still Post diam. 60 mm.**  
Template, fixing bolts and small metal parts to secure the base to the ground.

**Gabarit, tire-fond et visserie pour poteau Still**  
Gabarit, tire-fond et visserie pour l'ancrage du socle au sol.

COL.	CODE	€
Black	LB11254	13,00

### Adattatore palo Still Ø 60 Trend 60

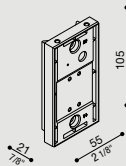

Base in policarbonato, ottenuta da stampaggio ad iniezione proprio. Da utilizzare in sostituzione della base standard Trend 60.

**Adaptor for Still Post Ø 60 Trend 60**  
Base for pole installation, injection moulded in-house, to be used in alternative to the standard base of article Trend 60.

**Adaptateur poteau Still Ø60 Trend 60**  
Base en polycarbonate, s'obtient du moulage à injection propre, à utiliser en alternative à la base standard de l'article Trend 60.

COL.	CODE	€
Black	LB1290006	5,80

### Cover Trend 60

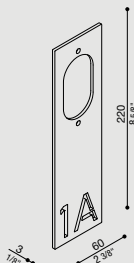

Cover decorativa in PMMA personalizzabile. Specificare in fase d'ordine la personalizzazione richiesta.

**Cover Trend 60**  
Decorative cover moulded in PMMA.  
Specify the customization required when ordering.

**Cover Trend 60**  
Cover décorative moulée en PMMA.  
Spécifier la personnalisation désiré au moment de la commande.

COL.	CODE	€
Black	LB1290001	29,00
Grey	LB1290002	29,00
Dark Grey	LB1290003	29,00
Brown	LB1290004	29,00
White	LB1290005	29,00





Trend 60

# Trend 60



Trend Up&Down 60 doppio blade



Trend 60



Trend 60

# Trend 60 Post

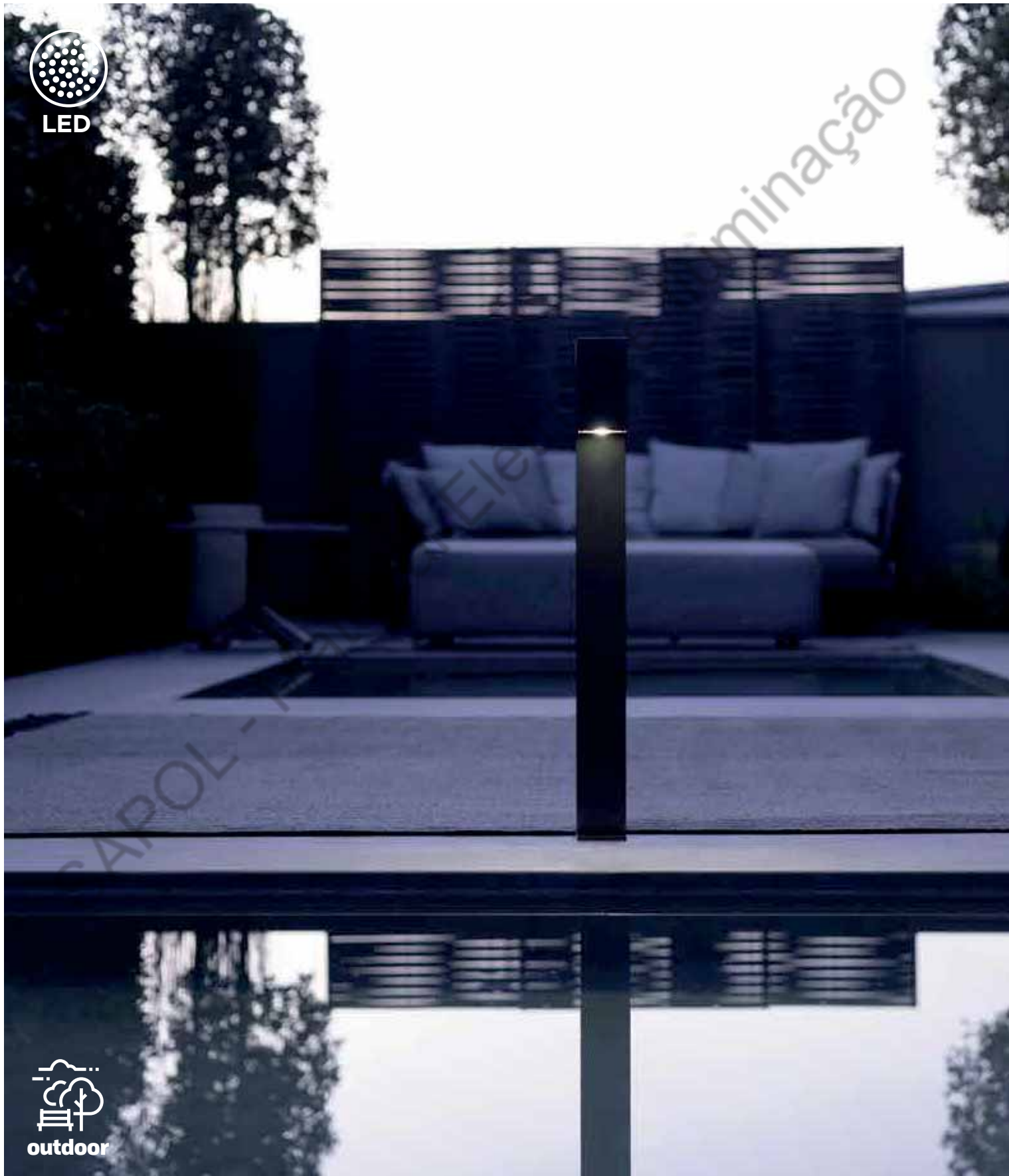

LED



outdoor





Adatto ad uso esterno.

Corpo in alluminio pressofuso; elevata resistenza all'ossidazione grazie al trattamento di cataforesi e alla verniciatura con resine poliestere stabilizzata ai raggi UV.

Diffusore in vetro temprato e serigrafato.

Guarnizioni in silicone. Riflettore in alluminio anodizzato.

Bulloneria in acciaio inox A4.

Palo da giardino in estruso di alluminio con base in alluminio anodizzato

**LED 4000K (N), 3000K (3) o 2700K (2). Alimentazione diretta 220-240V.**

**Nessun rischio fotobiologico, RGO gruppo di rischio esente (EN62471).**

**ENG** Suitable for indoor and outdoor use.

Die-cast aluminium body; highly resistant to oxidization due to cataphoresis treatment and UV stabilized polyester resin coating.

Heat tempered and silk-screen printed glass diffuser.

Silicone gaskets.

Reflector made of anodized aluminium.

A4 stainless steel nuts and bolts.

Post for garden use made of extruded aluminum with aluminum anodized base.

**LED 4000K (N), 3000K (3) or 2700K (2). Integral ballast 220-240V.**

**No risk of photobiological damage, RGO group (EN62471).**

**FRA** Également adapté pour l'usage à l'extérieur.

Corps en aluminium injecté; haute résistance à l'oxydation grâce au traitement de cataphorèse et laquage poudre à base de résines polyesters, fixées aux rayons UV.

Diffuseur en verre trempé et sérigraphié.

Jointes en silicone.

Réflecteur en aluminium anodisé.

Visserie en acier inox type A4.

Poteau de jardin en aluminium extrudé avec base en aluminium anodisé.

**LED 4000K (N), 3000K (3) ou 2700K (2).**

**Alimentation intégrée 220-240V.**

**Pas de risque photobiologique, RGO groupe (EN62471).**

**Trend 60 Post H600**



**Trend 60 Post H800**



**Outdoor  
e waterproof**



**Alimentazione diretta**

Direct power supply  
Alimentation directe



**Cataforesi**

Cataphoresis  
Cataphorèse



**Anni di garanzia  
sul circuito LED**

Years warranty on LED circuit  
Ans de garantie sur la source LED



# Trend 60 Post

<b>Trend 60 Post H600</b>				<b>DIFF. DIFF.</b>	<b>DIFF. TRASP.</b>			
<b>IP 66 IK 07 2J xx5 CE UK CA</b>								
LED	W	LM	REAL LM	COL.	CODE *	CODE *	€	* LED COLOUR
3	500	250-260	220-240 V		LL129200□	LL129204□	197,00	4000K
					LL129201□	LL129205□	197,00	3000K, lm -5%
					LL129202□	LL129206□	197,00	2700K, lm -5%
					LL129203□	LL129207□	197,00	

Fascio di luce asimmetrico.  
H 600 mm.

Asymmetrical beam.  
H 600 mm.

Faisceau lumineux asymétrique.  
H 600 mm.

<b>Trend 60 Post H800</b>				<b>DIFF. DIFF.</b>	<b>DIFF. TRASP.</b>			
<b>IP 66 IK 07 2J xx5 CE UK CA</b>								
LED	W	LM	REAL LM	COL.	CODE *	CODE *	€	* LED COLOUR
3	500	250-260	220-240 V		LL129301□	LL129305□	232,50	4000K
					LL129302□	LL129306□	232,50	3000K, lm -5%
					LL129303□	LL129307□	232,50	2700K, lm -5%
					LL129304□	LL129308□	232,50	

Fascio di luce asimmetrico.  
H 800 mm.

Asymmetrical beam.  
H 800 mm.

Faisceau lumineux asymétrique.  
H 800 mm.

## Finishing

	Bianco RAL 9010 White RAL 9010 Blanc RAL 9010		Grigio antracite RAL 7021 Grey anthracite RAL 7021 Gris anthracite RAL 7021
	Grigio High Tech RAL 9006 Grey High Tech RAL 9006 Gris High Tech RAL 9006		Corten Corten Corten

## \* Led colour

- 4000K
- 3000K, lm -5%
- 2700K, lm -5%

**Completa il codice** sostituendo al quadrato rosso la lettera o il numero corrispondente alla temperatura colore scelta.

**Complete the code** by replacing the red box with the letter or number corresponding to the selected colour temperature.

**Compléter le code** en remplaçant le carré rouge par la lettre ou le numéro correspondant à la sélection de température couleur.

## ✔ Alimentatore integrato

Integrated driver  
Alimentation intégrée



Fascio di luce asimmetrico.  
 Asymmetrical beam.  
 Faisceau lumineux  
 asymétrique.

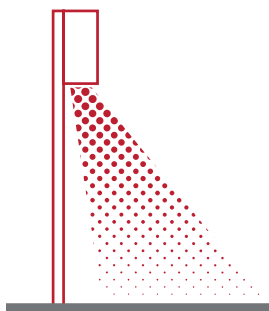

Trend 60 post



Trend 60 post



Trend 60 post

# Fix



LED



indoor



outdoor



Adatto anche ad uso esterno. Driver 220-240V integrato e Led di ultima generazione.  
 Corpo e tappo in alluminio primario pressofuso EN-AB46100; elevata resistenza all'ossidazione grazie al trattamento di passivazione a base di zirconio e alla verniciatura con resine poliesteri stabilizzata ai raggi UV.  
 Diffusore in vetro temprato effetto satinato. Guarnizione in silicone.  
 Bulloneria in acciaio A4 o AISI 316L.

**LED 4000K (N), 3000K (3) o 2700K (2). Alimentazione diretta 220-240V.**  
**Nessun rischio fotobiologico, RGO gruppo di rischio esente (EN62471).**

**ENG** Suitable for indoor and outdoor use.  
 Integrated driver 220-240V and the latest generation of Led.  
 Body and cover made of EN-AB46100 die-cast aluminium primary alloy; highly resistant to oxidization thanks to the zirconium-based passivation treatment and UV stabilized polyester resin coating.  
 Tempered glass diffuser with frosted effect.  
 Silicone gaskets.  
 A4 or AISI 316L stainless steel nuts and bolts.  
**LED 4000K (N), 3000K (3) o 2700K (2). Integrated driver 220-240V.**  
 No risk of photobiological damage, RGO group (EN62471).

**FRA** Également adapté à l'usage à l'extérieur.  
 Alimentation intégrée 220 - 240V et Led de dernière génération.  
 Corps et couverture en aluminium primaire injecté EN-AB46100; haute résistance à l'oxydation grâce au traitement de passivation à base de zirconium et laquage poudre à base de résines polyesters, fixées au rayon UV. Diffuseur en verre trempé effet satiné.  
 Joints en silicone.  
 Visserie en acier inox type A4 ou AISI 316L.  
**LED 4000K (N), 3000K (3) ou 2700K (2) (blanche chaud). Alimentation intégrée 220-240. Pas de risque photobiologique, RGO groupe (EN62471).**

**Fix 503**



**Outdoor  
 e waterproof**



**Alimentazione diretta**  
 Direct power supply  
 Alimentation directe

**Fix 504**

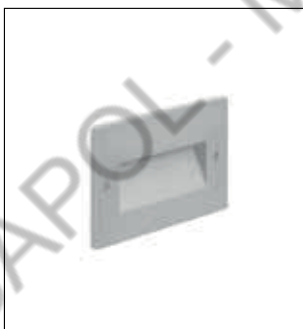

**Installazione rapida**  
 Quick installation  
 Installation rapide



**Anni di garanzia  
 sul circuito LED**  
 Years warranty on LED circuit  
 Ans de garantie sur la source LED

**Fix 506**



3 mm



## Fix 503

DIFF.  
VETRO

IP66 IK 10 20J xx9 CE UK  
CA

LED	W	LM	REAL LM	COL.	CODE *	€	* LED COLOUR
	4,2	450	225	⊕	LL120000□	80,50	N 4000K
				⊕	LL120001□	80,50	3 3000K, lm -5%
				⊕	LL120002□	80,50	2 2700K, lm -5%
				⊕	LL120003□	80,50	

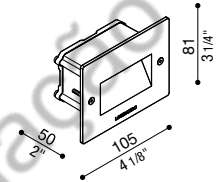

Predisposto per singolo ingresso alimentazione.

Single cable entry at the back.

Entrée d'alimentation simple.

## Fix 504

DIFF.  
VETRO

IP66 IK 10 20J xx9 CE UK  
CA

LED	W	LM	REAL LM	COL.	CODE *	€	* LED COLOUR
	5,6	600	300	⊕	LL120004□	99,50	N 4000K
				⊕	LL120005□	99,50	3 3000K, lm -5%
				⊕	LL120006□	99,50	2 2700K, lm -5%
				⊕	LL120007□	99,50	

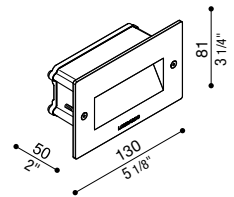

Predisposto per singolo ingresso alimentazione.

Single cable entry at the back.

Entrée d'alimentation simple.

## Fix 506

DIFF.  
VETRO

IP66 IK 10 20J xx9 CE UK  
CA

LED	W	LM	REAL LM	COL.	CODE *	€	* LED COLOUR
	7,2	750	375	⊕	LL120008□	116,00	N 4000K
				⊕	LL120009□	116,00	3 3000K, lm -5%
				⊕	LL120010□	116,00	2 2700K, lm -5%
				⊕	LL120011□	116,00	

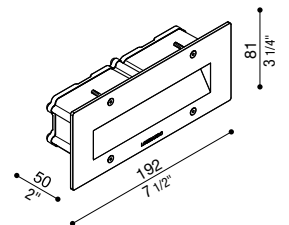

Predisposto per doppio ingresso alimentazione.

Double cable entry at the back.

Possibilità alimentazione double entrée.

### Finishing

 Bianco RAL 9010 White RAL 9010 Blanc RAL 9010	 Grigio antracite RAL 7021 Grey anthracite RAL 7021 Gris anthracite RAL 7021
 Grigio High Tech RAL 9006 Grey High Tech RAL 9006 Gris High Tech RAL 9006	 Corten Corten Corten

### \* Led colour

- N 4000K
- 3 3000K, lm -5%
- 2 2700K, lm -5%

**Completa il codice**  
sostituendo al quadrato rosso la lettera o il numero corrispondente alla temperatura colore scelta.

**Complete the code**  
by replacing the red box with the letter or number corresponding to the selected colour temperature.

**Compléter le code**  
en remplaçant le carré rouge par la lettre ou le numéro correspondant à la sélection de température couleur.

 **Alimentatore integrato**  
Integrated driver  
Alimentation intégrée





**ACCESSORI**  
Accessories / Accessoires

**Scatola Incasso Standard 503**

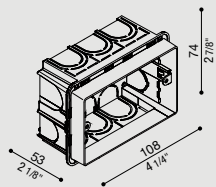

Recess Box 503

Armature à encastrer standard 503

COL.	CODE	€
	LB11660	3,30

**Scatola Incasso Standard 504**

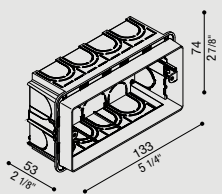

Recess Box 504

Armature à encastrer standard 504

COL.	CODE	€
	LB11690	5,30

**Scatola Incasso Standard 506L**

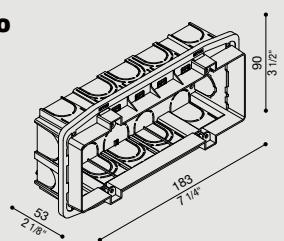

Recess Box 506L

Armature à encastrer standard 506L

COL.	CODE	€
	LB11680	13,50

**Morsettiere**  
Terminal blocks



**Scaricatori SPD**  
Surge protector devices



Pag. 448



Installazione in scatole standard.  
Installation with recess boxes.  
Installation avec boîtes standards.



Colori disponibili.  
Available colours.  
Couleurs disponibles.



# Fix

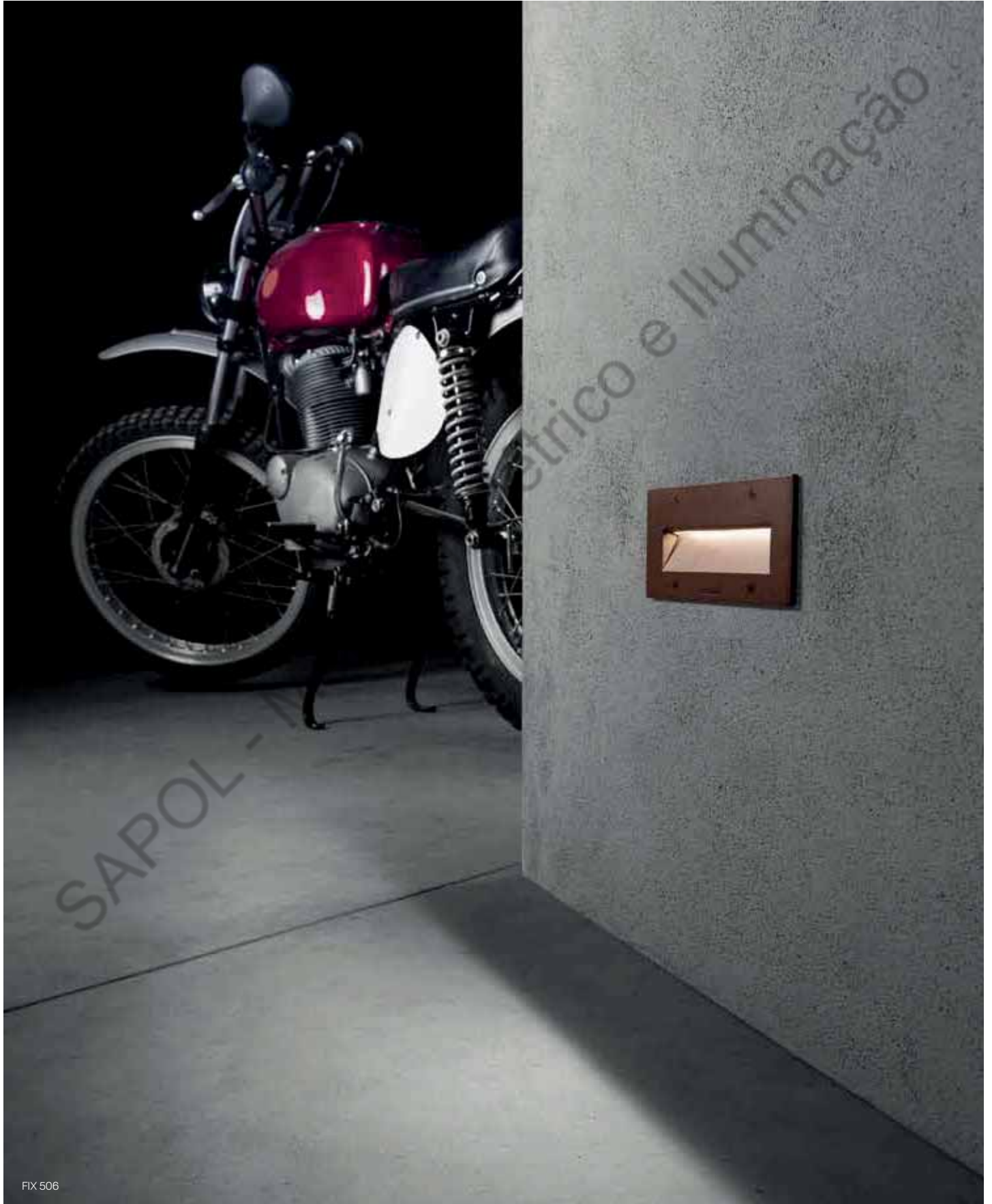



FIX 503



FIX 504

# Pin



LED



indoor



outdoor

**ACCESSORI**

Accessories / Accessoires

Pag. 381



Adatto anche ad uso esterno. Corpo in alluminio primario pressofuso EN-AB44100; elevata resistenza all'ossidazione grazie al trattamento di cataforesi. Diffusore in vetro temprato e serigrafato.

Apparecchio inaccessibile fornito con 0.20 m di cavo di alimentazione H05RN-F pre-cablato e resinato.

LED a tensione di rete.

Dimmerabile a taglio di fase.

**LED 4000K (N), 3000K (3) o 2700K (2). LED a tensione di rete.**

**Nessun rischio fotobiologico, RGO gruppo di rischio esente (EN62471).**

**ENG** Suitable for indoor and outdoor use.

Body made of EN - AB44100 die-cast aluminum primary alloy; highly resistant to oxidization due to cataphoresis treatment.

Heat tempered and silk-screen printed glass diffuser.

Inaccessible device, provided with 0.20 m of prewired power cable H05RN-F with epoxy resin treatment.

LED AC direct. Dimmable Phase cut.

**LED 4000K (N), 3000K (3) or 2700K (2). LED AC direct.**

**No risk of photobiological damage, RGO group (EN62471).**

**FRA** Également adapté pour l'usage à l'extérieur.

Corps en aluminium primaire injecté EN-AB44100; haute résistance à l'oxydation grâce au traitement de cataphorèse

Diffuseur en verre trempé et sérigraphié.

Appareil câblé en usine, fourni avec 0.20 m de câble d'alimentation H05RN-F-pré-câblé.

LED Direct 220-240. Dimmable coupure de Phase.

**LED 4000K (N), 3000K (3) ou 2700K (2) (blanche chaude).**

**LED Direct 220-240. Pas de risque photobiologique, RGO groupe (EN62471).**

**Pin T**



**Pin T Asimmetrico**



**Outdoor e waterproof**



**Pin Q**



**Pin Q Asimmetrico**



**Pre-cablato**

Pre-wired  
Pré-câblé



**Cataforesi**

Cataphoresis  
Cataphorèse



**Installazione rapida**

Quick installation  
Installation rapide



**Dimmerabile**

Dimmable  
Dimmable

Disponibile online download della dima per la ghiera di fissaggio.

Available online template for fixing retaining ring.

Disponible online gabarit pour bague de fixation.

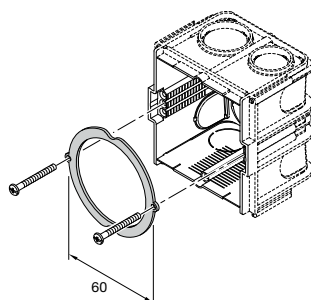

**Anni di garanzia sul circuito LED**

Years warranty on LED circuit  
Ans de garantie sur la source LED



# Pin

<b>Pin T</b>				<b>DIFF. TRASP.</b>							
<b>IP 66 IK 07 2J xx5</b>											
<b>LED</b>	<b>W</b>	<b>LM</b>	<b>REAL LM</b>	<b>COL.</b>	<b>CODE *</b>	<b>€</b>	<b>* LED COLOUR</b>				
2	200	56			LL125000□	52,50	N 4000K				
					LL125001□	52,50	3 3000K, lm -5%				
					LL125002□	52,50	2 2700K, lm -5%				
					LL125003□	52,50					
2	200	56			LL125100□	60,00					
					LL125101□	60,00					
					LL125102□	60,00					
					LL125103□	60,00					
Codici LL12510: KIT composto da Pin T + armatura da incasso 502 LB1250001.				Codes LL12510: Kit consisting of Pin T + recess box 502 LB1250001.						Codes LL12510: Kit composé des Pin T + armature à encastrer 502 LB1250001.	

<b>Pin T Asimmetrico</b>				<b>DIFF. TRASP.</b>							
<b>IP 66 IK 07 2J xx5</b>											
<b>LED</b>	<b>W</b>	<b>LM</b>	<b>REAL LM</b>	<b>COL.</b>	<b>CODE *</b>	<b>€</b>	<b>* LED COLOUR</b>				
2	200	67			LL125004□	52,50	N 4000K				
					LL125005□	52,50	3 3000K, lm -5%				
					LL125006□	52,50	2 2700K, lm -5%				
					LL125007□	52,50					
2	200	67			LL125104□	60,00					
					LL125105□	60,00					
					LL125106□	60,00					
					LL125107□	60,00					
Deflettore in alluminio. Codici LL12510: KIT composto da Pin T Asimmetrico + armatura da incasso 502 LB1250001.				Deflector made of aluminum. Codes LL12510: Kit consisting of Pin T Asimmetrico + recess box 502 LB1250001.						Réflecteur en aluminium. Codes LL12510: Kit composé des Pin T Asimmetrico + armature à encastrer 502 LB1250001.	

## Finishing



Neutro  
Neutral  
Neutre



Serigrafia Nera  
Black serigraphy  
Sérigraphie noir



Serigrafia Grigio High Tech  
Grey High Tech Serigraphy  
Sérigraphie Gris High Tech



Serigrafia Corten  
Corten serigraphy  
Sérigraphie Corten

## \* Led colour

- N 4000K
- 3 3000K, lm -5%
- 2 2700K, lm -5%

**Completa il codice** sostituendo al quadrato rosso la lettera o il numero corrispondente alla temperatura colore scelta.

**Complete the code** by replacing the red box with the letter or number corresponding to the selected colour temperature.

**Compléter le code** en remplaçant le carré rouge par la lettre ou le numéro correspondant à la sélection de température couleur.

**Alimentazione diretta**  
Integral ballast  
Alimentation intégrée  
 **220-240 V**



<b>Pin Q</b>				<b>DIFF. TRASP.</b>			
<b>IP 66 IK 07 2J xx5</b>							
LED	W	LM	REAL LM	COL.	CODE *		€
2	200	56	<b>AC DIRECT</b>	S	LL125008□	52,50	N 4000K 3 3000K, lm -5% 2 2700K, lm -5%
				S	LL125009□	52,50	
				S	LL125010□	52,50	
				S	LL125011□	52,50	
2	200	56	<b>AC DIRECT</b> <b>KIT</b> <b>PIN Q + BOX</b>	S	LL125108□	60,00	
				S	LL125109□	60,00	
				S	LL125110□	60,00	
				S	LL125111□	60,00	

Codici LL12510, LL12511: KIT composto da Pin Q + armatura da incasso 502 LB1250001.

Codes LL12510, LL12511: Kit consisting of Pin Q + recess box 502 LB1250001.

Codes LL12510, LL12511: Kit composé des Pin Q + armature à encastrer 502 LB1250001.

<b>Pin Q Asimmetrico</b>				<b>DIFF. TRASP.</b>			
<b>IP 66 IK 07 2J xx5</b>							
LED	W	LM	REAL LM	COL.	CODE *		€
2	200	67	<b>AC DIRECT</b>	S	LL125012□	52,50	N 4000K 3 3000K, lm -5% 2 2700K, lm -5%
				S	LL125013□	52,50	
				S	LL125014□	52,50	
				S	LL125015□	52,50	
2	200	67	<b>AC DIRECT</b> <b>KIT</b> <b>PIN Q ASIMM + BOX</b>	S	LL125112□	60,00	
				S	LL125113□	60,00	
				S	LL125114□	60,00	
				S	LL125115□	60,00	

Deflettore in alluminio.  
Codici LL12511: KIT composto da Pin Q Asimmetrico + armatura da incasso 502 LB1250001.

Deflector made of aluminum.  
Codes LL12511: Kit consisting of Pin Q Asimmetrico + recess box 502 LB1250001.

Réflecteur en aluminium.  
Codes LL12510, LL12511: Kit composé des Pin Q Asimmetrico + armature à encastrer 502 LB1250001.

**ACCESSORI**  
Accessories / Accessoires

<b>Scatola incasso standard 502</b>	Recess Box 502	Armature à encastrer standard 502	COL.	CODE	€
				LB1250001	7,30
<b>Scatola incasso cartongesso 502</b>	Recess Plasterboard wall Box 502	Armature à encastrer placoplâtre 502	COL.	CODE	€
				LB11693	6,30

**Morsettiere**  
Terminal blocks

**Scaricatori SPD**  
Surge protector devices

# Pin



Possibile scelta di 3 differenti serigrafie colorate: nero - grigio HT - Corten.

Possible choice of serigraphed glass in 3 different colours: black - HT grey - Corten.

Possibilité de choisir entre 3 sérigraphies colorées différentes : noir - gris HT - corten.



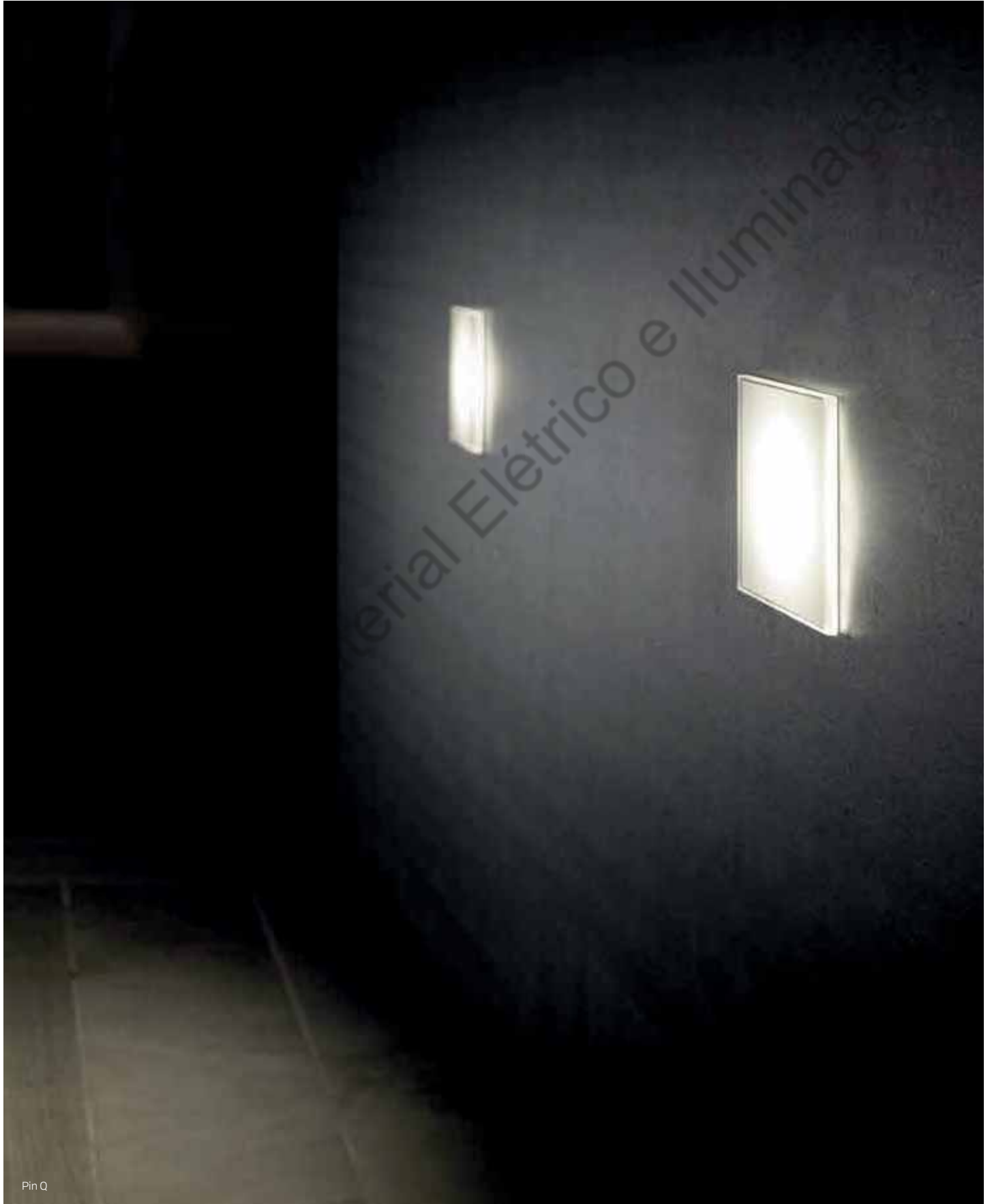

# Pin







Material Eléctrico e Iluminação



Pin T

# Stile next



## Incasso a muro con scatola standard

Installation with wall recessed box

Encastrement dans le mur avec boîte standards



503

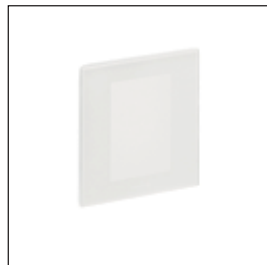

506E



506L

Scatole Standard  
recessed box  
boîte standards



503



506E



506L

## Incasso a muro ed in cartongesso

Recessed in wall and plasterboard

Encastrement dans le mur et dans le placoplâtre

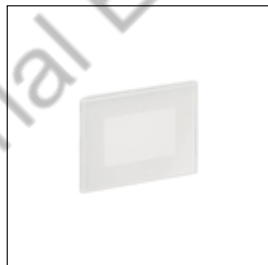

103

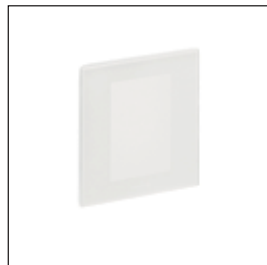

106E

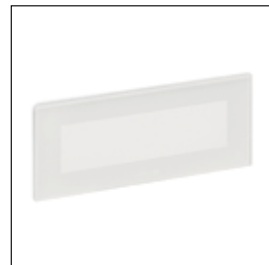

106L



103 asimmetrica



106L asimmetrica



106L asimmetrica orizzontale

### SENZA UTENSILI

Massima praticità per il montaggio ad incasso, che avviene semplicemente tramite sistema ad incastro adattabile alle diverse esigenze di profondità.

### TOOL FREE

Maximum practicality for the flush-fitting assembly consisting of a recessed system that can be adapted to suit various depths.

### SANS OUTILS

Grande facilité pour le montage par encastrement que l'on réalise de façon très simple au moyen d'un système d'encastrement qui s'adapte aux différentes exigences de profondeur.



503 asimmetrico



506L asimmetrico



506L asimmetrico orizzontale



**Alimentazione diretta**  
 Direct power supply  
 Alimentation directe



**Installazione rapida**  
 Quick installation  
 Installation rapide



**Anni di garanzia sul circuito LED**  
 Years warranty on LED circuit  
 Ans de garantie sur la source LED

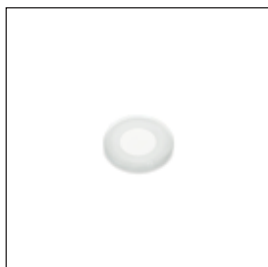

zero 60T



zero power 60T

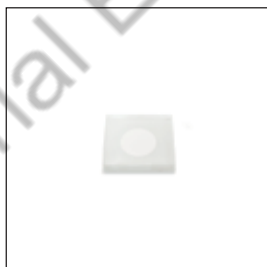

zero 60Q



zero power 60Q



zero 120T



zero power 120T



zero 120Q



zero power 120Q

# Stile next



LED



indoor



outdoor

**ACCESSORI**

Accessories / Accessoires

Pag. 392





Adatto anche ad uso esterno.

Corpo in alluminio primario pressofuso EN-AB44100; elevata resistenza all'ossidazione grazie al trattamento di passivazione a base di zirconio e alla verniciatura con resine poliestere stabilizzata ai raggi UV.

Diffusore in vetro temprato e serigrafato. Guarnizioni in silicone.

Bulloneria in acciaio inox A4 o AISI 316L.

Modello brevettato.

**LED 4000K (N), 3000K (3) o 2700K (2). Alimentazione diretta 220-240V.**

**Nessun rischio fotobiologico, RGO gruppo di rischio esente (EN62471).**

**ENG** Suitable for indoor and outdoor use.

Body made of EN-AB44100 die-cast aluminium primary alloy; highly resistant to oxidization due to the zirconium-based passivation treatment and UV stabilized polyester resin coating.

Heat tempered and serigraphed glass diffuser.

Silicone gaskets. A4 or AISI 316 L stainless steel nuts and bolts.

Patented model.

**LED 4000K (N), 3000K (3) or 2700K (2). Integral ballast 220-240V.**

No risk of photobiological damage, RGO group (EN62471).

**FRA** Egalement adapté à l'usage à l'extérieur.

Corps en aluminium primaire injecté EN-AB44100; haute résistance à l'oxydation, car passivé à base de zirconium et laquage poudre à base de résines polyester, fixé aux rayons UV.

Diffuseur en verre trempé et sérigraphié. Joints en silicone.

Visserie en acier inox type A4 ou AISI 316L.

Modèle breveté.

**LED 4000K (N), 3000K (3) ou 2700K (2) (blanche chaud).**

**Alimentation intégrée 220-240. Pas de risque photobiologique, RGO groupe (EN62471).**

**Stile next 503**

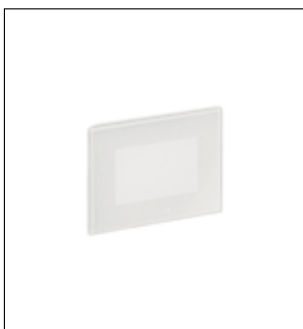

**Stile next 506E**



**Outdoor  
e waterproof**



**Alimentazione diretta**

Direct power supply  
Alimentation directe

**Stile next 506L**

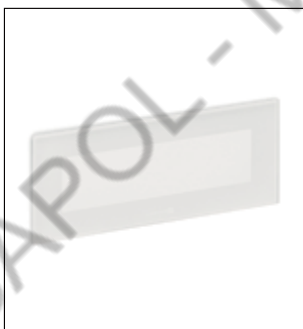

**Stile next 503 asimmetrico**



**Anni di garanzia  
sul circuito LED**

Years warranty on LED circuit  
Ans de garantie sur la source LED

**Stile next 506L  
asimmetrico**



**Stile next 506L  
asimmetrico orizzontale**

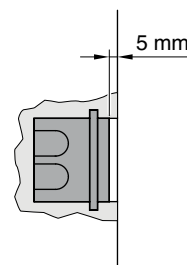
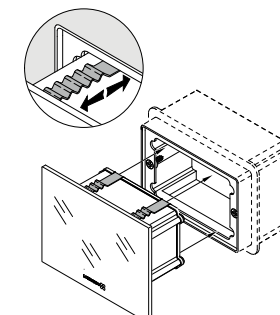

Incasso a muro con scatola. Consigliato incassare la scatola di 5 mm rispetto alla parete per agevolare l'installazione.

Wall recessed fixture. It is advisable to mount the box with a 5mm. recess compared with the wall to facilitate installation.

Encastrément mural. Il est conseillé d'encaisser la boîte de 5mm par rapport au mur pour faciliter l'installation



# Stile next

## Stile next 503

DIFF.  
OPAL.

IP 66 IK 06 1J xx3 CE UK  
CA

LED	W	LM	REAL LM	COL.	CODE *	€	* LED COLOUR
3	310	68	⊕ 220-240 V		LL641C□	92,00	N 4000K
					LL641C2□	92,00	3 3000K, lm -5%
					LL641CG□	92,00	2 2700K, lm -5%
					LL641CK□	92,00	
6	720	170	⊕ 220-240 V		LL641D□	139,00	

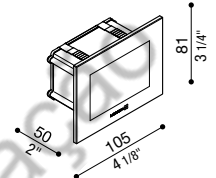

Possibile scelta di 3 differenti serigrafie colorate: nero - grigio HT - corten. Predisposto per singolo ingresso alimentazione.

Possible choice of serigraphed glass in 3 different colours: black - HT grey - corten. Single cable entry at the back.

Possibilité de choisir entre 3 sérigraphies colorées différentes: noir - gris HT - corten. Entrée d'alimentation simple.

## Stile next 506E

DIFF.  
OPAL.

IP 66 IK 06 1J xx3 CE UK  
CA

LED	W	LM	REAL LM	COL.	CODE *	€	* LED COLOUR
6	720	283	⊕ 220-240 V		LL651D□	174,00	N 4000K 3 3000K, lm -5%

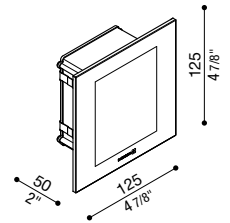

Predisposto per doppio ingresso alimentazione.

Double cable entry at the back.

Possibilité alimentation double entrée.

## Stile next 506L

DIFF.  
OPAL.

IP 66 IK 06 1J xx3 CE UK  
CA

LED	W	LM	REAL LM	COL.	CODE *	€	* LED COLOUR
6	720	217	⊕ 220-240 V		LL661D□	150,50	N 4000K
					LL661D2□	150,50	3 3000K, lm -5%
					LL661DG□	150,50	2 2700K, lm -5%
					LL661DK□	150,50	

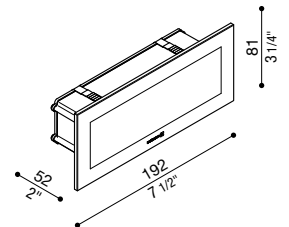

Possibile scelta di 3 differenti serigrafie colorate: nero - grigio HT - corten. Predisposto per doppio ingresso alimentazione.

Possible choice of serigraphed glass in 3 different colours: black - HT grey - corten. Double cable entry at the back.

Possibilité de choisir entre 3 sérigraphies colorées différentes: noir - gris HT - corten. Possibilité alimentation double entrée.



**Stile next 503  
asimmetrico**

DIFF.  
TRASP.

IP 66 IK 06 1J xx3 CE UK CA

LED	W	LM	REAL LM	COL.	CODE *	€	* LED COLOUR
	3	310	45		LL643C□	104,00	N 4000K
				S	LL643C2□	104,00	3 3000K, lm -5%
				S	LL643CG□	104,00	2 2700K, lm -5%
				S	LL643CK□	104,00	

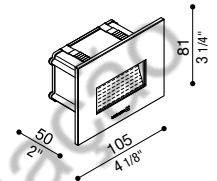

Possibile scelta di 3 differenti serigrafie colorate: nero - grigio HT - corten. Predisposto per singolo ingresso alimentazione. Deflettore in alluminio primario pressofuso EN-AB44100.

Possible choice of serigraphed glass in 3 different colours: black - HT grey - corten. Single cable entry at the back. Reflector made of EN-AB44100 die-cast aluminium primary alloy.

Possibilité de choisir entre 3 sérigraphies colorées différentes: noir - gris HT - corten. Entrée d'alimentation simple. Réflecteur en aluminium primaire injecté EN-AB44100.

**Stile next 506L  
asimmetrico**

DIFF.  
TRASP.

IP 66 IK 06 1J xx3 CE UK CA

LED	W	LM	REAL LM	COL.	CODE *	€	* LED COLOUR
	3	310	38		LL663C□	163,00	N 4000K 3 3000K, lm -5%

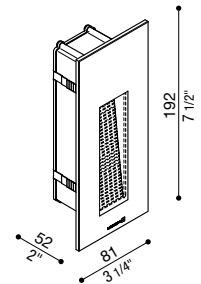

Predisposto per doppio ingresso alimentazione. Deflettore in alluminio primario pressofuso EN-AB44100.

Double cable entry at the back. Reflector made of EN-AB44100 die-cast aluminium primary alloy.

Possibilité alimentation double entrée. Réflecteur en aluminium primaire injecté EN-AB44100.

**Stile next 506L  
asimmetrico  
orizzontale**

DIFF.  
TRASP.

IP 66 IK 06 1J xx3 CE UK CA

LED	W	LM	REAL LM	COL.	CODE *	€	* LED COLOUR
	4	490	70		LL665F□	163,00	N 4000K
				S	LL665F2□	163,00	3 3000K, lm -5%
				S	LL665FG□	163,00	2 2700K, lm -5%
				S	LL665FK□	163,00	

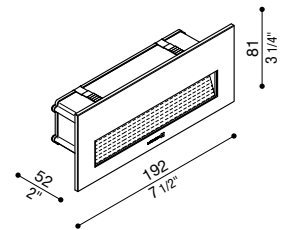

Possibile scelta di 3 differenti serigrafie colorate: nero - grigio HT - corten. Predisposto per doppio ingresso alimentazione. Deflettore in alluminio primario pressofuso EN-AB44100.

Possible choice of serigraphed glass in 3 different colours: black - HT grey - corten. Double cable entry at the back. Reflector made of EN-AB44100 die-cast aluminium primary alloy.

Possibilité de choisir entre 3 sérigraphies colorées différentes: noir - gris HT - corten. Possibilité alimentation double entrée. Réflecteur en aluminium primaire injecté EN-AB44100.

**Finishing**

	Neutro Neutral Neutre		Serigrafia Grigio High Tech Grey High Tech Serigraphy Sérigraphie Gris High Tech
	Serigrafia Nera Black serigraphy Sérigraphie noir		Serigrafia Corten Corten serigraphy Sérigraphie Corten

**\* Led colour**

- N 4000K
- 3 3000K, lm -5%
- 2 2700K, lm -5%

**Completa il codice** sostituendo al quadrato rosso la lettera o il numero corrispondente alla temperatura colore scelta.

**Complete the code** by replacing the red box with the letter or number corresponding to the selected colour temperature.

**Compléter le code** en remplaçant le carré rouge par la lettre ou le numéro correspondant à la sélection de température couleur.

**Alimentatore integrato**  
Integrated driver  
Alimentation intégrée

# Stile next

## ACCESSORI

Accessories / Accessoires

### Palo Stile Next

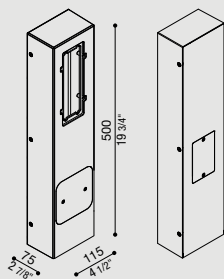

Palo multifunzionale in tecnopolimero completo di coperchi amovibili (da asportare nel caso si applichino apparecchi) e relativa bulloneria. Obbligatoria l'installazione del modello 506-L, non compreso. Predisposto per accogliere anche un coperchio per presa elettrica della Bticino mod. IDROBOX LUNA IP55 - Cod. 24602L.

#### Post Stile Next

Multi-purpose technopolymer post complete with removable covers (to be removed to accommodate the light fixtures) and all required nuts and bolts. Model 506L must be mounted (article to be ordered separately). It has been designed to accommodate an IP rated electric socket manufactured by Bticino mod. IDROBOX LUNA IP55 - Code 24603L.

#### Poteau Stile Next

Poteau multifonctionnel en technopolymère avec couvercles amovibles (à retirer pour appliquer les appareils) et visserie. L'installation du modèle 506-L, non compris, est obligatoire. Il a été également conçu pour l'application d'un couvercle de la prise de courant Bticino mod. IDROBOX LUNA IP55 - Cod. 24603L.

COL.	CODE	€
■	LB11652	43,00
■	LB1165G	59,50
■	LB1165K	65,50

### Dima e kit di fissaggio Palo Stile Next

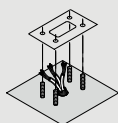

Dima, tirafondi e minuteria per ancoraggio del palo al terreno.

#### Template and fixing kit for post Stile Next

Template, fixing bolts and small metal parts to secure the post to the ground.

#### Gabarit, tire-fond et visserie pour ancrage du poteau Stile Next

Gabarit, tire-fond et visserie pour ancrage du poteau au sol.

COL.	CODE	€
■	LB11255	15,50

### Scatola Incasso Standard 503

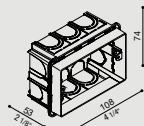

#### Recess Box 503

#### Armature à encastrer standard 503

COL.	CODE	€
■	LB11660	3,30

### Scatola Incasso Standard 506E

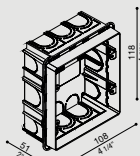

#### Recess Box 506E

#### Armature à encastrer standard 506E

COL.	CODE	€
■	LB11670	13,50

### Scatola Incasso Standard 506L

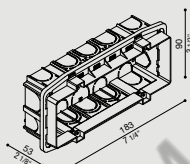

#### Recess Box 506L

#### Armature à encastrer standard 506L

COL.	CODE	€
■	LB11680	13,50

### Palo Stile Next Alluminio

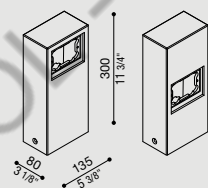

Palo multifunzionale per modelli Stile Next 503 – Stile Next 503 asimmetrico. Adatto per uso esterno, idoneo per applicazioni a pavimento. Struttura palo realizzata in alluminio pressofuso; elevata resistenza all'ossidazione grazie al trattamento di passivazione a base di zirconio e alla verniciatura con resine poliestere stabilizzata ai raggi UV. Bulloneria inclusa.

#### Aluminium Post Stile Next

Multi-purpose post for Stile Next 503 – Stile Next 503 asymmetric. Suitable for outdoor use and floor installation. Post in die-cast aluminium; highly resistant to oxidization thanks to the zirconium-based passivation treatment and UV stabilized polyester resin coating. Nuts and bolts included.

#### Poteau aluminium pour Stile Next

Poteau multifonctionnel pour Stile Next 503 – Stile Next asymmetric. Adapté à l'usage à l'extérieur et pour une application au sol. Poteau réalisé en aluminium injecté; haute résistance à l'oxydation, grâce à un traitement de passivation à base de zirconium et laquage poudre à base de résines polyesters, fixées aux rayons UV. Fixation comprise.

Versione monoemissione - Unidirectional version - Version unidirectionnelle

Versione biemissione - Bidirectional version - Version bidirectionnelle

COL.	CODE	€
■	LB1100000	84,00
■	LB1100002	84,00
■	LB1100001	84,00

COL.	CODE	€
■	LB1100003	84,00
■	LB1100005	84,00
■	LB1100004	84,00

### Box Alluminio 503

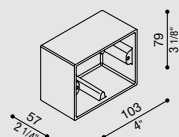

Box per montaggio sporgente a parete (non per incasso).

Corpo in alluminio primario pressofuso EN-AB44100; elevata resistenza all'ossidazione grazie al trattamento di passivazione a base di zirconio e alla verniciatura con resine poliestere stabilizzata ai raggi UV.

#### Box in aluminium 503

Box for surface wall mounting (not recessed). Body made of EN-AB44100 die-cast aluminium primary alloy; highly resistant to oxidization thanks to the zirconium-based passivation treatment and UV stabilized polyester resin coating.

#### Box aluminium 503

Box pour le montage au mur en saillie (pas à encastrement). Corps en aluminium primaire injecté EN-AB44100; haute résistance à l'oxydation grâce au traitement de passivation à base de zirconium et laquage poudre à base de résines polyesters, fixées au rayon UV.

COL.	CODE	€
■	LB11841	27,00
■	LB1184G	27,00



**ACCESSORI**

Accessories / Accessoires

**Box Alluminio 506E**

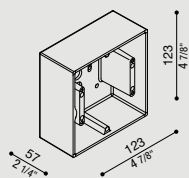

Box per montaggio sporgente a parete (non per incasso).  
Corpo in alluminio primario pressofuso EN-AB44100; elevata resistenza all'ossidazione grazie al trattamento di passivazione a base di zirconio e alla verniciatura con resine poliestere stabilizzata ai raggi UV.

**Box in aluminium 506E**  
Box for surface wall mounting (not recessed).  
Body made of EN-AB44100 die-cast aluminium primary alloy; highly resistant to oxidation thanks to the zirconium-based passivation treatment and UV stabilized polyester resin coating.

**Box Aluminium 506E**  
Box pour le montage au mur en saillie (pas à encastrement).  
Corps en aluminium primaire injecté EN-AB44100; haute résistance à l'oxydation grâce au traitement de passivation à base de zirconium et laquage poudre à base de résines polyesters, fixées au rayon UV.

COL.	CODE	€
	<b>LB11611</b>	<b>30,50</b>
	<b>LB1161G</b>	<b>30,50</b>

**Box Alluminio 506L**

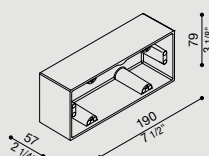

Box per montaggio sporgente a parete (non per incasso).  
Corpo in alluminio primario pressofuso EN-AB44100; elevata resistenza all'ossidazione grazie al trattamento di passivazione a base di zirconio e alla verniciatura con resine poliestere stabilizzata ai raggi UV.

**Box in aluminium 506L**  
Box for surface wall mounting (not recessed).  
Body made of EN-AB44100 die-cast aluminium primary alloy; highly resistant to oxidation thanks to the zirconium-based passivation treatment and UV stabilized polyester resin coating.

**Box Aluminium 506L**  
Box pour le montage au mur en saillie (pas à encastrement).  
Corps en aluminium primaire injecté EN-AB44100; haute résistance à l'oxydation grâce au traitement de passivation à base de zirconium et laquage poudre à base de résines polyesters, fixées au rayon UV.

COL.	CODE	€
	<b>LB11621</b>	<b>30,50</b>
	<b>LB1162G</b>	<b>30,50</b>



Disponibile anche con finitura "CORTEN"  
Available with CORTEN finish  
Finition CORTEN disponible

**Ancora un passo avanti**

Per l'installazione a terra Stile Next dispone di un robusto paletto in tecnopolimero, nero o verniciato in grigio high tech. Predisposto per alloggiare il modello Stile Next 506-L su un lato e integrabile sull'altro con Stile Next 503 consentendo nuovi utilizzi grazie alla doppia illuminazione; inoltre è predisposto per accogliere anche un coperchio per presa elettrica della Bticino mod. IDROBOX LUNA IP55 - Cod. 24602L.

**Another step forward**

For ground mounted column installation, Stile Next can offer a sturdy technopolymer post in black or coated in high tech grey. Designed to hold model Stile Next 506-L on one side, and optionally with Stile Next 503 on the other, it can also be used for new purposes thanks to the dual lighting possibility. Furthermore, it has also been designed to accommodate an IP rated electric socket manufactured by Bticino mod. IDROBOX LUNA IP55 - Code 24602L.

**Encore un pas en avant**

Pour l'installation au sol Stile Next dispose d'un robuste poteau en technopolymère, noir ou laqué de couleur gris High Tech. Conçu pour loger d'un côté le modèle Stile Next 506-L et de l'autre côté pour intégrer le modèle Stile Next 503; il réalise ainsi de nouvelles utilisations grâce au double éclairage; il a été également conçu pour l'application d'un couvercle de la prise de courant Bticino mod. IDROBOX LUNA IP55 - Cod. 24602L.



Fronte - Front - Devant      Retro - Back - Derrière

Il paletto è provvisto di coperchi amovibili, che vanno asportati nel caso si applichino gli apparecchi (non inclusi).

The post is provided with removable covers which can be removed to accommodate the luminaires (to be ordered separately).

Le poteau est muni de couvercles amovibles que l'on peut retirer quand on applique les appareils (non inclus).



# Stile Next



LED



indoor



outdoor

**ACCESSORI**

Accessories / Accessoires

Pag. 398





Adatto per installazioni a parete e controsoffittature in cartongesso o ad uso esterno.  
 Corpo in alluminio primario pressofuso EN-AB44100; elevata resistenza all'ossidazione grazie al trattamento di passivazione a base di zirconio e alla verniciatura con resine poliestere stabilizzata ai raggi UV.  
 Diffusore in vetro temprato e serigrafato. Guarnizioni in silicone.  
 Bulloneria in acciaio inox A4 o AISI 316L.  
 Modello brevettato.

**LED 4000K (N) o 3000K (3). Alimentazione diretta 220-240V.**  
**Nessun rischio fotobiologico, RGO gruppo di rischio esente (EN62471).**

**ENG** Suitable for installation on plasterboard walls and ceilings and for outdoor use.

Body made of EN-AB44100 die-cast aluminium primary alloy; highly resistant to oxidization thanks to the zirconium-based passivation treatment and UV stabilized polyester resin coating. Heat tempered and serigraphed glass diffuser. Silicone gaskets. A4 or AISI 316L stainless steel nuts and bolts. Patented model.

LED 4000K (N) or 3000K (3). Integral ballast 220-240V. No risk of photobiological damage, RGO group (EN62471).

**FRA** Egalement adapté pour les installations murales et les faux plafonds en placoplâtre et à l'usage à l'extérieur.

Corps en aluminium primaire injecté EN-AB44100; haute résistance à l'oxydation grâce au traitement de passivation à base de zirconium et laquage poudre à base de résines polyesters, fixées au rayon UV. Diffuseur en verre trempé et sérigraphié. Joints en silicone. Visserie en acier inox type A4 ou AISI 316L. Modèle breveté.

LED 4000K (N) ou 3000K (3) (blanche chaud). Alimentation intégrée 220-240.

Pas de risque photobiologique, RGO groupe (EN62471).

**Stile next 103**

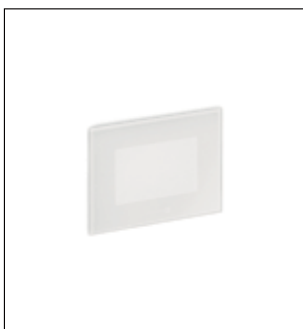

**Stile next 106E**



**Outdoor  
 e waterproof**



**Alimentazione diretta**  
 Direct power supply  
 Alimentation directe

**Stile next 106L**

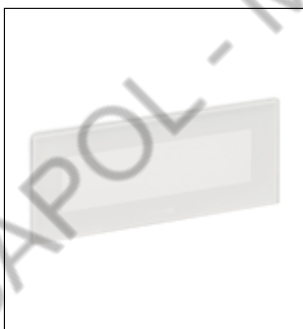

**Stile next 103 asimmetrica**



**Anni di garanzia  
 sul circuito LED**  
 Years warranty on LED circuit  
 Ans de garantie sur la source LED

Incasto a muro ed in cartongesso senza l'utilizzo di scatola.  
 Recessed in wall and plasterboard without any box.  
 Encastrement dans le mur et dans le placoplâtre sans utilisation de boîte.

**Stile next 106L  
 asimmetrica**



**Stile next 106L  
 asimmetrica orizzontale**

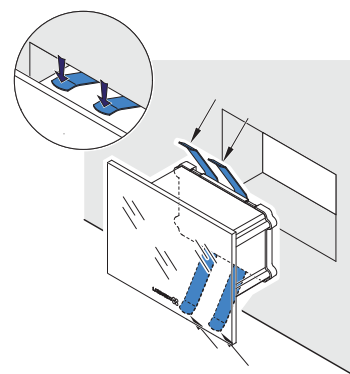

# Stile Next

## Stile next 103

DIFF.  
OPAL.

IP 66 IK 06 1J xx3 CE UK  
CA

LED	W	LM	REAL LM		COL.	CODE *	€	* LED COLOUR
3	310	68		⊕ ✓ 220-240 V	□	LL642C□	122,50	N 4000K 3 3000K, lm -5%
6	720	170		⊕ ✓ 220-240 V	□	LL642D□	149,00	
3	360	85		⊕ ✗ 24V	□	LL643D□	135,50	

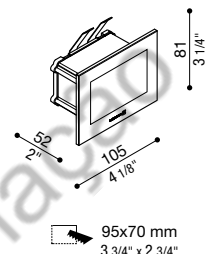

Kit composto dagli attuali codici LB11854 + LL642CN/3.

Kit consisting of the current codes LB11854 + LL642CN/3.

Kit composé des codes actuels LB11854 + LL642CN/3.

## Stile next 106E

DIFF.  
OPAL.

IP 66 IK 06 1J xx3 CE UK  
CA

LED	W	LM	REAL LM		COL.	CODE *	€	* LED COLOUR
6	720	283		⊕ ✓ 220-240 V	□	LL652D□	181,50	N 4000K 3 3000K, lm -5%
6	720	283		⊕ ✗ 24V	□	LL653D□	152,50	
3	270	96		⊕ ✓ 220-240 V	□	LL6523□	186,50	

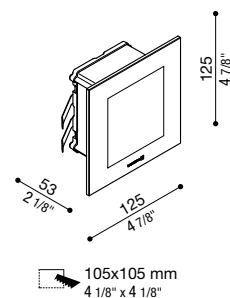

Predisposto per doppio ingresso alimentazione. LL653DN/3 alimentatore escluso.

Double cable entry at the back. LL653DN/3 ballast not included.

Possibilità alimentazione double entrée. LL653DN/3 ballast exclus.

## Stile next 106L

DIFF.  
OPAL.

IP 66 IK 06 1J xx3 CE UK  
CA

LED	W	LM	REAL LM		COL.	CODE *	€	* LED COLOUR
6	720	217		⊕ ✓ 220-240 V	□	LL662D□	169,00	N 4000K 3 3000K, lm -5%
6	720	217		⊕ ✗ 24V	□	LL663D□	152,50	
3	270	94		⊕ ✓ 220-240 V	□	LL6623□	186,50	

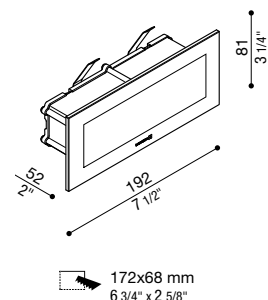

Predisposto per doppio ingresso alimentazione. LL663DN/3 alimentatore escluso.

Double cable entry at the back. LL663DN/3 ballast not included.

Possibilità alimentazione double entrée. LL663DN/3 ballast exclus.



**Stile next 103  
asimmetrica**

DIFF.  
TRASP.

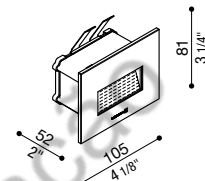

IP 66 IK 06 1J xx3 CE UK CA

LED	W	LM	REAL LM	COL.	CODE *	€	* LED COLOUR
3	310	45			LL644C□	134,50	N 4000K 3 3000K, lm -5%

Predisposto per singolo ingresso alimentazione. Deflettore in alluminio primario pressofuso EN-AB44100.

Single cable entry at the back.  
Reflector made of EN-AB44100 die-cast aluminium primary alloy.

Entrée d'alimentation simple.  
Réflecteur en aluminium primaire injecté EN-AB44100

**Stile next 106L  
asimmetrica**

DIFF.  
TRASP.

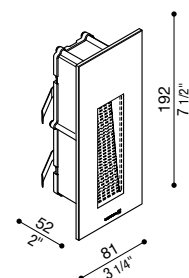

IP 66 IK 06 1J xx3 CE UK CA

LED	W	LM	REAL LM	COL.	CODE *	€	* LED COLOUR
3	310	38			LL664C□	181,50	N 4000K 3 3000K, lm -5%

Predisposto per doppio ingresso alimentazioni. Deflettore in alluminio primario pressofuso EN-AB44100.

Double cable entries at the back.  
Reflector made of EN-AB44100 die-cast aluminium primary alloy.

Possibilità alimentazione doppia entrata. Réflecteur en aluminium primaire injecté EN-AB44100.

**Stile next 106L  
asimmetrica  
orizzontale**

DIFF.  
TRASP.

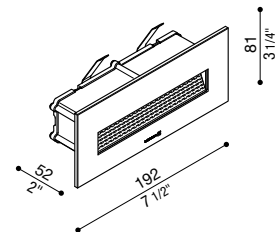

IP 66 IK 06 1J xx3 CE UK CA

LED	W	LM	REAL LM	COL.	CODE *	€	* LED COLOUR
4	490	70			LL666F□	181,50	N 4000K 3 3000K, lm -5%

Predisposto per doppio ingresso alimentazioni. Deflettore in alluminio primario pressofuso EN-AB44100.

Double cable entry at the back.  
Reflector made of EN-AB44100 die-cast aluminium primary alloy.

Possibilità alimentazione doppia entrata. Réflecteur en aluminium primaire injecté EN-AB44100.

**Finishing**



Neutro  
Neutral  
Neutre

**\* Led colour**

- N 4000K
- 3 3000K, lm -5%

**Completa il codice**  
sostituendo al quadrato rosso la lettera o il numero corrispondente alla temperatura colore scelta.

**Complete the code**  
by replacing the red box with the letter or number corresponding to the selected colour temperature.

**Compléter le code**  
en remplaçant le carré rouge par la lettre ou le numéro correspondant à la sélection de température couleur.

**✓ Alimentatore integrato**

Integrated driver  
Alimentation intégrée

**✗ Alimentatore escluso**

Driver not included  
Alimentation non incluse

# Stile Next

## ACCESSORI

Accessories / Accessoires

### Cassaforma Polistirolo Stile Next 103

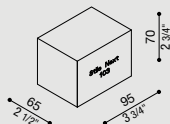

Cassaforma in polistirolo.

Polystyrene mould  
Stile Next 503  
Polystyrene mould.

Gabarit en polystyrène  
Stile Next 103  
Gabarit en polystyrène.

COL.	CODE	€
	<b>LB11571</b>	<b>3,30</b>

### Cassaforma Polistirolo Stile Next 106L

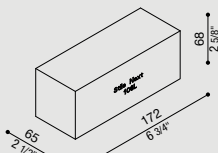

Cassaforma in polistirolo.

Polystyrene mould  
Stile Next 106L  
Polystyrene mould.

Gabarit en polystyrène  
Stile Next 106L  
Gabarit en polystyrène.

COL.	CODE	€
	<b>LB11573</b>	<b>5,30</b>

### Cassaforma Polistirolo Stile Next 106E

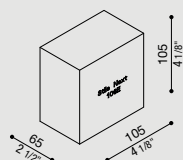

Cassaforma in polistirolo.

Polystyrene mould  
Stile Next 106E  
Polystyrene mould.

Gabarit en polystyrène  
Stile Next 106E  
Gabarit en polystyrène.

COL.	CODE	€
	<b>LB11572</b>	<b>4,30</b>

**Morsettiere**  
Terminal blocks



**Scaricatori SPD**  
Surge protector devices



Pag. 448

SAPOL - Material Eléctrico e Iluminação



Stile Next 103/503 Asimmetrica



Stile Next 103/503



# Stile Next



indoor



outdoor

**ACCESSORI**

Accessories / Accessoires

Pag. 405



Adatto per incasso da terra a filo della superficie, anche ad uso esterno e carrabile, carico massimo 2000 kg. Corpo in alluminio primario pressofuso EN-AB44100; elevata resistenza all'ossidazione grazie al trattamento di passivazione a base di zirconio e alla verniciatura con resine poliestere stabilizzata ai raggi UV. Diffusore in vetro temprato e serigrafato ad alto spessore 10 mm, solidale al corpo in alluminio tramite doppio strato di resinatura ad alta tenuta. 3 m di cavo di alimentazione H05RN-F pre-cablato e bloccato tramite apposita resinatura posteriore, che rende l'apparecchio inaccessibile.

Il fissaggio del prodotto alla relativa armatura da incasso, fornita a parte, avviene tramite apposite molle di ritenuta che ne consentono l'ancoraggio. Bulloneria in acciaio inox A4 o AISI 316L. Modello brevettato.

**LED 4000K (N) o 3000K (3). Alimentazione diretta 220-240V. Nessun rischio fotobiologico, RGO gruppo di rischio esente (EN62471).**

**ENG** Suitable for recessed flush ground application, also for outdoor use and drive-over, max load 2000 kgs.

Body made of EN-AB44100 die-cast aluminium primary alloy; highly resistant to oxidization thanks to the zirconium-based passivation treatment and UV stabilized polyester resin coating.

Heat tempered and serigraphed glass diffuser, 10 mm thickness, integral to the aluminium body with a double layer of high resistant resin. 3 metre pre-wired cable type H05RN-F, secured by means of a back resin preventing any access to the fixture.

The fixture is fixed to the appropriate recessed box - supplied separately - by means of retaining springs.

Nuts and bolts in A4 stainless steel or AISI 316L. Patented model.

**LED 4000K (N) or 3000K (3). Integral ballast 220-240V.**

No risk of photobiological damage, RGO group (EN62471)

**FRA** Convient également pour une utilisation au sol mais aussi pour une utilisation extérieure carrossable charge maxi 2000kg. Corps en aluminium primaire injecté EN-AB4410; haute résistance à l'oxydation, grâce à un traitement de passivation à base de zirconium et laquage poudre à base de résines polyesters, fixées aux rayons UV.

Diffuseur en verre trempé et sérigraphié épaisseur 10mm; soudé au corps en aluminium par une double couche de résine à haute résistance. Cordon d'alimentation H05RN-F de 3m pré-câblé et bloqué par un tour de résine spéciale, qui rend le dispositif inaccessible.

La fixation du bâti à la boîte d'encastrement, fournie à part, se fait par l'intermédiaire de ressorts d'ancrage. Fixation en acier inox type A4 ou AISI 316L. Modèle breveté.

**LED 4000K (N) ou 3000K (3) (blanche chaud). Alimentation intégrée 220-240V. Pas de risque photobiologique, RGO groupe (EN62471).**



**Outdoor  
e waterproof**



**Anni di garanzia  
sul circuito LED**

Years warranty on LED circuit  
Ans de garantie sur la source LED

**Stile next zero 60T**



**Stile next zero power 60T**



**Stile next zero 60Q**

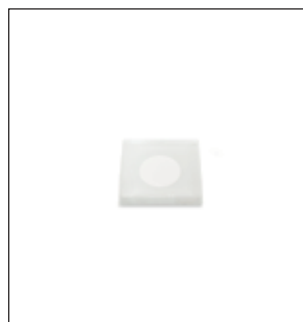

**Stile next zero power 60Q**



**Stile next zero 120T**



**Stile next zero power 120T**



**Stile next zero 120Q**



**Stile next zero power 120Q**



# Stile Next

<b>Stile next zero 60T</b>				<b>DIFF. OPAL.</b>	Fino ad esaurimento. Until our stock lasts. Jusqu'à épuisement de stock.	
IP 67 IK 10 20J xx9						
<b>LED</b>	W	LM	REAL LM	COL.	CODE *	€ * LED COLOUR
	3	230	38	220-240 V	LL104B□	184,50

Temperatura massima rilevata sul vetro 60°C.

Max temperature on the glass 60°C.

Température relevée sur le verre 60° C maxi.

<b>Stile next zero power 60T</b>				<b>DIFF. TRASP.</b>	Fino ad esaurimento. Until our stock lasts. Jusqu'à épuisement de stock.	
IP 67 IK 10 20J xx9						
<b>LED</b>	W	LM	REAL LM	COL.	CODE **	€ * OPTIC * LED COLOUR
	3	230	93	220-240 V	LL105B□	184,50
	2	229	186	220-240 V	LL105A□□	202,50

Temperatura massima rilevata sul vetro 60°C.

Max temperature on the glass 60°C.

Température relevée sur le verre 60° C maxi.

<b>Stile next zero 60Q</b>				<b>DIFF. OPAL.</b>	Fino ad esaurimento. Until our stock lasts. Jusqu'à épuisement de stock.	
IP 67 IK 10 20J xx9						
<b>LED</b>	W	LM	REAL LM	COL.	CODE *	€ * LED COLOUR
	3	230	38	220-240 V	LL134B□	184,50

Temperatura massima rilevata sul vetro 60°C.

Max temperature on the glass 60°C.

Température relevée sur le verre 60° C maxi.

## Finishing



Neutro  
Neutral  
Neutre

Alimentatore integrato  
Integrated driver  
Alimentation intégrée



### Stile next zero power 60Q

DIFF. TRASP.

Fino ad esaurimento.  
Until our stock lasts.  
Jusqu'à épuisement de stock.

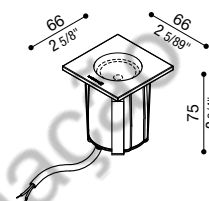

IP 67 IK 10 20J xx9 CE UK CA 2000 KG MAX 60° MAX

LED	W	LM	REAL LM	COL.	CODE **	€	* OPTIC	* LED COLOUR
3	230	93	220-240 V		LL135B□	184,50	S 13° M 29° L 48°	N 4000K 3 3000K, Im -5%
2	229	186	220-240 V		LL135A□□	202,50		

### Stile next zero 120T

DIFF. OPAL.

Fino ad esaurimento.  
Until our stock lasts.  
Jusqu'à épuisement de stock.

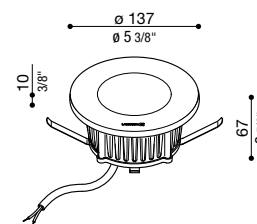

IP 67 IK 10 20J xx9 CE UK CA 2000 KG MAX 55° MAX

LED	W	LM	REAL LM	COL.	CODE *	€	* LED COLOUR
4,5	725	260	220-240 V		LL677H□	296,50	N 4000K 3 3000K, Im -5%

Temperatura massima rilevata sul vetro 55°C.

Max temperature on the glass 55°C.

Température relevée sur le verre 55° C maxi.

### Stile next zero power 120T

DIFF. TRASP.

Fino ad esaurimento.  
Until our stock lasts.  
Jusqu'à épuisement de stock.

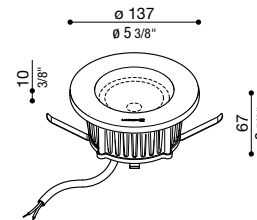

IP 67 IK 10 20J xx9 CE UK CA 2000 KG MAX 70° MAX

LED	W	LM	REAL LM	COL.	CODE **	€	* OPTIC	* LED COLOUR
8	900	502	220-240 V		LL697H□	296,50	S 10° M 20° L 40°	N 4000K 3 3000K, Im -5%
3,5	378	305	220-240 V		LL697C□□	313,00		

Temperatura massima rilevata sul vetro 70°C.

Max temperature on the glass 70°C.

Température relevée sur le verre 70° C maxi.

**\* Led colour**  
N 4000K  
3 3000K, Im -5%

**Completa il codice**  
sostituendo al quadrato rosso la lettera o il numero corrispondente alla temperatura colore scelta.

**Complete the code**  
by replacing the red box with the letter or number corresponding to the selected colour temperature.

**Compléter le code**  
en remplaçant le carré rouge par la lettre ou le numéro correspondant à la sélection de température couleur.

**\* Optic**

**Completa il codice**  
sostituendo al quadrato grigio la lettera corrispondente al modello di ottica scelta.

**Complete the code**  
by replacing the grey box with the letter corresponding to the selected optic model.

**Compléter le code**  
en remplaçant le carré gris par la lettre correspondante au modèle de lentille choisie.

# Stile Next

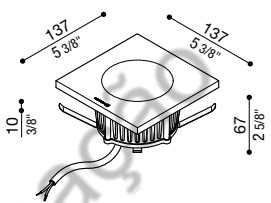
<b>Stile next zero 120Q</b>		<b>DIFF. OPAL.</b>		Fino ad esaurimento. Until our stock lasts. Jusqu'à épuisement de stock.			
<b>IP 67 IK 10 20J xx9</b>							
<b>LED</b>	<b>W</b>	<b>LM</b>	<b>REAL LM</b>	<b>COL.</b>	<b>CODE *</b>	<b>€</b>	<b>* LED COLOUR</b>
	4,5	725	260	220-240 V	LL687H□	296,50	4000K 3000K, lm -5%

Temperatura massima rilevata sul vetro 55°C.

Max temperature on the glass 55°C.

Température relevée sur le verre 55° C maxi.

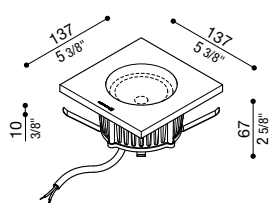
<b>Stile next zero power 120Q</b>		<b>DIFF. TRASP.</b>		Fino ad esaurimento. Until our stock lasts. Jusqu'à épuisement de stock.			
<b>IP 67 IK 10 20J xx9</b>							
<b>LED</b>	<b>W</b>	<b>LM</b>	<b>REAL LM</b>	<b>COL.</b>	<b>CODE **</b>	<b>€</b>	<b>* OPTIC * LED COLOUR</b>
	8	900	502	220-240 V	LL707H□	296,50	10° 20° 40° 4000K 3000K, lm -5%
	3,5	378	305	220-240 V	LL707C□□	313,00	

Temperatura massima rilevata sul vetro 70°C.

Max temperature on the glass 70°C.

Température relevée sur le verre 70° C maxi.



Diffusore in vetro temprato e serigrafato ad alto spessore 10 mm  
Heat tempered and serigraphed glass diffuser, 10 mm thickness  
Diffuseur en verre trempé et sérigraphié, épaisseur 10 mm

Corpo in alluminio pressofuso EN-AB4100  
Body made of EN-AB4100 die-cast aluminium primary alloy  
Corps en aluminium moulé sous pression EN-AB4100

Resinatura posteriore  
Back resin  
Couche de résine postérieure

Bulloneria in acciaio Inox A4  
Nuts and bolts in A4 stainless steel  
Fixation en acier Inox A4

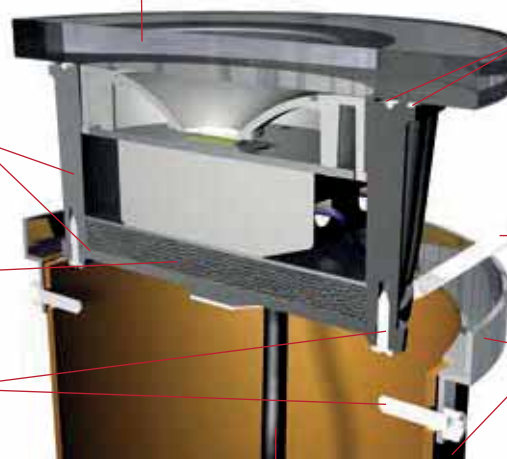

Doppio strato resinatura ad alta tenuta  
Double layer of high resistant resin  
Double couche de résine à haute résistance

Molle di ritenuta per ancoraggio prodotto  
Retaining springs  
Ressorts de retenue pour ancrage

Armatura da incasso in acciaio AISI 316L  
Recessed box made of AISI 316L stainless steel  
Armature d'encastrement en acier AISI 316L

Cavo di alimentazione H05RN-F pre-cablato da 3 m  
3 Metre pre-wired cable type H05RN-F  
Câble d'alimentation H05RN-F pré-câblé de 3 m





**ACCESSORI**  
Accessories / Accessoires

**Armatura da incasso Stile Next Zero 120T**

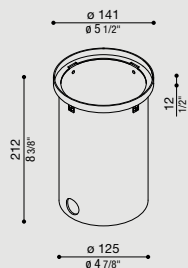

Armatura da incasso completa di collare superiore in acciaio inox AISI 316L, da posizionare a filo con la superficie di installazione.

**Recess box Stile Next Zero 120T**  
Recessed box complete with upper collar made of AISI 316L stainless steel, flush to the installation surface.

**Boîte d'encastrement Stile Next Zero 120T**  
Boîte d'encastrement avec collier supérieur en acier AISI type EN-AB44100, à placer au ras de la surface de montage.

COL.	CODE	€
	<b>LB11582</b>	<b>30,00</b>

**Armatura da incasso Stile Next Zero 120Q**

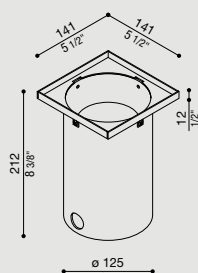

Armatura da incasso completa di collare superiore in acciaio inox AISI 316L, da posizionare a filo con la superficie di installazione.

**Recess box Stile Next Zero 120Q**  
Recessed box complete with upper collar made of AISI 316L stainless steel, flush to the installation surface.

**Boîte d'encastrement Stile Next Zero 120Q**  
Boîte d'encastrement avec collier supérieur en acier AISI type EN-AB44100, à placer au ras de la surface de montage.

COL.	CODE	€
	<b>LB11581</b>	<b>30,00</b>

**Armatura da incasso Stile Next Zero 60T**

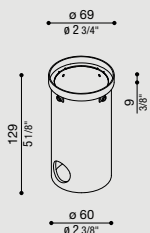

Armatura da incasso completa di collare superiore in acciaio inox AISI 316L, da posizionare a filo con la superficie di installazione.

**Recess box Stile Next Zero 60T**  
Recessed box complete with upper collar made of AISI 316L stainless steel, flush to the installation surface.

**Boîte d'encastrement Stile Next Zero 60T**  
Boîte d'encastrement avec collier supérieur en acier AISI type EN-AB44100, à placer au ras de la surface de montage.

COL.	CODE	€
	<b>LB11584</b>	<b>26,50</b>

**Armatura da incasso Stile Next Zero 60Q**

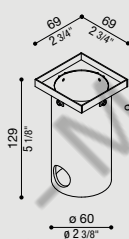

Armatura da incasso completa di collare superiore in acciaio inox AISI 316L, da posizionare a filo con la superficie di installazione.

**Recess box Stile Next Zero 60Q**  
Recessed box complete with upper collar made of AISI 316L stainless steel, flush to the installation surface.

**Boîte d'encastrement Stile Next Zero 60Q**  
Boîte d'encastrement avec collier supérieur en acier AISI type EN-AB44100, à placer au ras de la surface de montage.

COL.	CODE	€
	<b>LB11583</b>	<b>26,50</b>

**Ventosa Stile Next Zero 120T-120Q**



Ventosa per estrazione modelli Stile Next Zero

**Suction cup Stile Next Zero 120T-120Q**  
Suction cup to extract the models Stile Next Zero.

**Vetouse pour extraction Stile Next Zero 120T-120Q**  
Vetouse pour extraction pour les modèles Stile Next Zero.

COL.	CODE	€
	<b>LB11190</b>	<b>22,00</b>

**Ventosa Stile Next Zero 60T-60Q**



Ventosa per estrazione modelli Stile Next Zero.

**Suction cup Stile Next Zero 60T-60Q**  
Suction cup to extract the models Stile Next Zero.

**Vetouse pour extraction Stile Next Zero 60T-60Q**  
Vetouse pour extraction pour les modèles Stile Next Zero.

COL.	CODE	€
	<b>LB11191</b>	<b>22,00</b>

# Stile Next 260



Adatto anche ad uso esterno. Base in policarbonato e diffusore in vetro temprato e serigrafato.

Riflettore in alluminio tipo L2-1060. Guarnizioni in silicone.

Doppio pressacavo PG 13+ tappo di chiusura per singola alimentazione.

Viti imperdibili in acciaio inox A4 a testa esagonale ch.2,5.

**LED 4000K (N) o 3000K (3). Alimentazione diretta 220-240V.**

**Nessun rischio fotobiologico, RGO gruppo di rischio esente (EN62471).**

**ENG** Suitable for indoor and outdoor use.

Polycarbonate base and tempered serigraphed glass diffuser.

Reflector made of aluminium type L2-1060.

Silicone gaskets. PG 13 double cable gland + cover for single power supply.

A4 stainless steel captive hex screws size 2.5 mm. Patented model.

**LED 4000K (N) or 3000K (3). Integral ballast 220-240V.**

No risk of photobiological damage, RGO group (EN62471).

**FRA** Egalement adapté à l'usage à l'extérieur.

Base en polycarbonate et diffuseur en verre trempé et sérigraphié.

Réflecteur en aluminium type L2-1060. Joints en silicone. Double serre-câble PG

13 + bouchon de fermeture pour alimentation simple. Vis six pans creux ch. 2,5 en

acier inox type A4. Modèle breveté.

**LED 4000K (N) ou 3000K (3) (blanche chaud).**

Alimentation intégrée 220-240.

Pas de risque photobiologique, RGO groupe (EN62471).

## Stile next 260



**Outdoor  
e waterproof**



**Alimentazione diretta**

Direct power supply  
Alimentation directe



**Anni di garanzia  
sul circuito LED**

Years warranty on LED circuit  
Ans de garantie sur la source LED



**Stile next 260**

DIFF.  
OPAL.

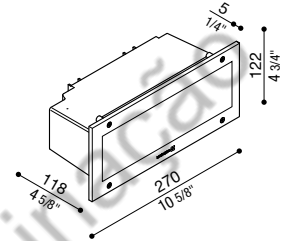

IP 66 IK 06 1J xx3 CE UK CEA

LED	W	LM	REAL LM	COL.	CODE *	€	* LED COLOUR
	10	1300	386	☉	LL785E☐	146,00	N 4000K 3 3000K, lm -5%
220-240 V							
LAMP	ATT.	LAMP MAX	CFL				
	E27	1x20	☉	☐	LB7852N	104,00	

Lampade dim. max: E27 145 mm Ø 48 mm.

Lamp dim. max: E27 145 mm Ø 48 mm.

Lampes dim. max: E27 145 mm Ø 48 mm.

**Finishing**



**\* Led colour**

- N 4000K
- 3 3000K, lm -5%

**Completa il codice**  
sostituendo al quadrato rosso la lettera o il numero corrispondente alla temperatura colore scelta.

**Complete the code**  
by replacing the red box with the letter or number corresponding to the selected colour temperature.

**Compléter le code**  
en remplaçant le carré rouge par la lettre ou le numéro correspondant à la sélection de température couleur.

**Alimentatore integrato**

Integrated driver  
Alimentation intégrée

**Armatura da incasso Stile 260 Stile Next 260**

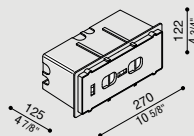

Armatura da incasso in termoplastico.

Thermoplastic recess box Stile 260 - Stile Next 260  
Thermoplastic recess box.

Armature à encastrer Stile 260 / Stile Next 260  
Armature à encastrer en matériau thermoplastique.

**ACCESSORI**

Accessories / Accessoires

COL.	CODE	€
	LB11530	11,50

**Cassaforma Polistirolo Stile 260 Stile Next 260**

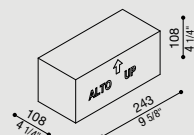

Cassaforma in polistirolo.

Polystyrene mould Stile 260 - Stile Next 260  
Polystyrene mould.

Gabarit en polystyrène Stile 260 / Stile Next 260  
Gabarit en polystyrène.

COL.	CODE	€
	LB11550	1,50

**Morsettiere**  
Terminal blocks



**Scaricatori SPD**  
Surge protector devices



# Kit Stile next Post



**Kit-01 / kit-02 / kit-03 / kit-04:** Palo multifunzionale in tecnopolimero completo di coperchi amovibili (da asportare nel caso si applichino apparecchi) e relativa bulloneria.

**Kit-05 / kit-06 / kit-07 / kit-08 / kit-09 / kit-10:** Palo multifunzionale per modelli Stile next 503 – Stile next 503 asimmetrico. Adatto per uso esterno, idoneo per applicazioni a pavimento. Struttura palo realizzata in alluminio pressofuso; elevata resistenza all'ossidazione grazie al trattamento di passivazione a base di zirconio e alla verniciatura con resine poliesteri stabilizzata ai raggi UV. Bulloneria inclusa.

**Kit-11 / kit-12:** Struttura in cemento per installazione a pavimento con diverse finiture cromatiche e relativa bulloneria. Stile next adatto anche ad uso esterno. Corpo in alluminio primario pressofuso EN-AB44100; elevata resistenza all'ossidazione grazie al trattamento di passivazione a base di zirconio e alla verniciatura con resine poliesteri stabilizzata ai raggi UV. Diffusore in vetro temprato e serigrafato.

Guarnizioni in silicone. Bulloneria in acciaio inox A4 o AISI 316L. Modello brevettato.

**LED 4000K (N) o 3000K (3). Alimentazione diretta 220-240V.**

**Nessun rischio fotobiologico, RG0 gruppo di rischio esente (EN62471).**



**Outdoor  
e waterproof**



**Alimentazione diretta**  
*Direct power supply  
Alimentation directe*



**Anni di garanzia  
sul circuito LED**  
*Years warranty on LED circuit  
Ans de garantie sur la source LED*



**ENG Kit-01 / kit-02 / kit-03 / kit-04:** Multi-purpose technopolymer post complete with removable covers (to be removed to accommodate the light fixtures) and all required nuts and bolts.

**Kit-05 / kit-06 / kit-07 / kit-08 / kit-09 / kit-10:** Multi-purpose post for Stile Next 503 – Stile next 503 asimmetrico. Suitable for outdoor use and floor installation.

Post in die-cast aluminium; highly resistant to oxidization thanks to the zirconium-based passivation treatment and UV stabilized polyester resin coating. Nuts and bolts included.

**Kit-11 / kit-12:** Body made of concrete for ground application. Available in different colours. Fixing nuts and bolts included.

Stile next suitable for indoor and outdoor use.

Body made of EN-AB44100 die-cast aluminium primary alloy; highly resistant to oxidization due to the zirconium-based passivation treatment and UV stabilized polyester resin coating. Heat tempered and serigraphed glass diffuser. Silicone gaskets. A4 or AISI 316 L stainless steel nuts and bolts. Patented model. **LED 4000K (N) or 3000K (3).**

Integral ballast 220-240V. No risk of photobiological damage, RGO group (EN62471).

**FRA Kit-01 / kit-02 / kit-03 / kit-04:** Poteau multifonctionnel en technopolymère avec couvercles amovibles (à retirer pour appliquer les appareils) et visserie.

**Kit-05 / kit-06 / kit-07 / kit-08 / kit-09 / kit-10:** Poteau multifonctionnel pour Stile Next 503 – Stile Next asimmetrico. Adapté à l'usage à l'extérieur et pour une application au sol.

Poteau réalisé en aluminium injecté; haute résistance à l'oxydation, grâce à un traitement de passivation à base de zirconium et laquage poudre à base de résines polyesters, fixées aux rayons UV. Fixation comprise.

**Kit-11 / kit-12:** Structure en ciment pour installation au sol, avec des couleurs différentes, et visserie (fixation).

Stile next également adapté à l'usage à l'extérieur. Corps en aluminium primaire injecté EN-AB44100; haute résistance à l'oxydation, car passivé à base de zirconium et laquage poudre à base de résines polyesters, fixé aux rayons UV. Diffuseur en verre trempé et sérigraphié. Joints en silicone. Visserie en acier inox type A4 ou AISI 316L. Modèle breveté.

**LED 4000K (N) ou 3000K (3) (blanche chaud).**

Alimentation intégrée 220-240.

Pas de risque photobiologique, RGO groupe (EN62471).

**Kit-01 Stile Next Post**



**Kit-02 Stile Next Post**



**Kit-03 Stile Next Post**



**Kit-04 Stile next Post**



**Kit-05 Stile Next Post**



**Kit-06 Stile Next Post**



**Kit-07 Stile Next Post**



**Kit-08 Stile Next Post**



**Kit-09 Stile Next Post**



**Kit-10 Stile Next Post**



**Kit-11 Stile Next Post**



**Kit-12 Stile Next Post**





# Kit Stile next Post

## Kit-01 Stile Next Post

IP 66 IK 06 1J xx3 CE UK CRA

LED	W	LM	REAL LM	COL.	CODE *	€	* LED COLOUR
6	720	283			LL661001	193,50	N 4000K
					LL661005	210,00	S 3000K, lm -5%
					LL661009	216,50	

Versione Monoemissione. Kit composto dagli attuali codici LB11652/G/K + LL661DN/3.

Unidirectional version. Kit consisting of the current codes LB11652/G/K + LL661DN/3.

Version unidirectionnelle. Kit composé des codes actuels LB11652/G/K + LL661DN/3.

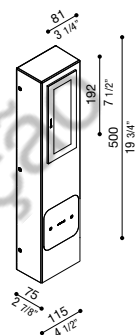

## Kit-02 Stile Next Post

IP 66 IK 06 1J xx3 CE UK CRA

LED	W	LM	REAL LM	COL.	CODE *	€	* LED COLOUR
3	310	38			LL661002	205,50	N 4000K
					LL661006	222,00	S 3000K, lm -5%
					LL661010	228,50	

Versione Monoemissione. Kit composto dagli attuali codici LB11652/G/K + LL663CN/3.

Unidirectional version. Kit consisting of the current codes LB11652/G/K + LL663CN/3.

Version unidirectionnelle. Kit composé des codes actuels LB11652/G/K + LL663CN/3.

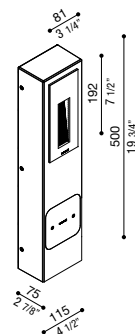

## Kit-03 Stile Next Post

IP 66 IK 06 1J xx3 CE UK CRA

LED	W	LM	REAL LM	COL.	CODE *	€	* LED COLOUR
6+3		283+68			LL661003	285,50	N 4000K
					LL661007	302,00	S 3000K, lm -5%
					LL661011	308,50	

Versione Biemissione. Kit composto dagli attuali codici LB11652/G/K + LL661DN/3 + LL641CN/3.

Bidirectional version. Kit consisting of the current codes LB11652/G/K + LL661DN/3 + LL641CN/3.

Version bidirectionnelle. Kit composé des codes actuels LB11652/G/K + LL661DN/3 + LL641CN/3.

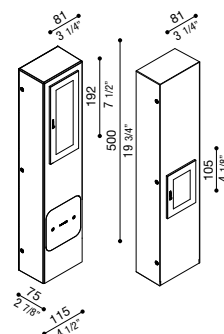

## Kit-04 Stile next Post

IP 66 IK 06 1J xx3 CE UK CRA

LED	W	LM	REAL LM	COL.	CODE *	€	* LED COLOUR
3+3		38+68			LL661004	297,50	N 4000K
					LL661008	314,00	S 3000K, lm -5%
					LL661012	320,50	

Versione Biemissione. Kit composto dagli attuali codici LB11652/G/K + LL663CN/3 + LL641CN/3.

Bidirectional version. Kit consisting of the current codes LB11652/G/K + LL663CN/3 + LL641CN/3.

Version bidirectionnelle. Kit composé des codes actuels LB11652/G/K + LL663CN/3 + LL641CN/3.

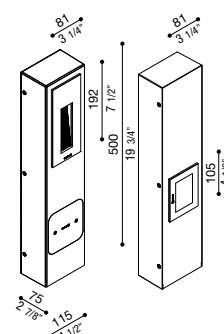



### Kit-05 Stile Next Post

DIFF. OPAL.

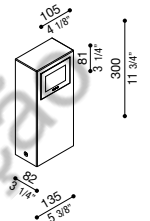

IP 66 IK 06 1J xx3 C E UK CA

LED	W	LM	REAL LM	COL.	CODE *	€	* LED COLOUR
3	310	68	⊕	220-240 V	LL110000□	176,50	N 4000K S 3000K, Im -5%
					LL110012□	176,50	
					LL110006□	176,50	
6	720	170	⊕	220-240 V	LL110018□	223,00	
					LL110019□	223,00	
					LL110020□	223,00	

Versione Monoemissione. Kit composto dagli attuali codici LB1100000/1/2 + LL641CN/3.

Unidirectional version. Kit consisting of the current codes LB1100000/1/2 + LL641CN/3.

Version unidirectionnelle. Kit composé des codes actuels LB1100000/1/2 + LL641CN/3.

### Kit-06 Stile Next Post

DIFF. TRASP.

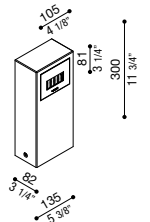

IP 66 IK 06 1J xx3 C E UK CA

LED	W	LM	REAL LM	COL.	CODE *	€	* LED COLOUR
3	310	45	⊕	220-240 V	LL110001□	189,00	N 4000K S 3000K, Im -5%
					LL110013□	189,00	
					LL110007□	189,00	

Versione monoemissione. Kit composto dagli attuali codici LB1100000/1/2 + LL643CN/3.

Unidirectional version. Kit consisting of the current codes LB1100000/1/2 + LL643CN/3.

Version unidirectionnelle. Kit composé des codes actuels LB1100000/1/2 + LL643CN/3.

### Kit-07 Stile Next Post

DIFF. OPAL.

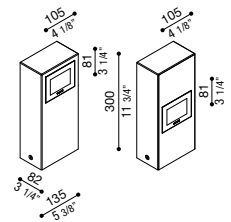

IP 66 IK 06 1J xx3 C E UK CA

LED	W	LM	REAL LM	COL.	CODE *	€	* LED COLOUR
3+3		68 + 68	⊕	220-240 V	LL110002□	268,50	N 4000K S 3000K, Im -5%
					LL110014□	268,50	
					LL110008□	268,50	
6+6		170+170	⊕	220-240 V	LL110021□	363,50	
					LL110022□	363,50	
					LL110023□	363,50	

Versione Biemissione. Kit composto dagli attuali codici LB1100003/4/5 + LL641CN/3 + LL641CN/3.

Bidirectional version. Kit consisting of the current codes LB1100003/4/5 + LL641CN/3 + LL641CN/3.

Version bidirectionnelle. Kit composé des codes actuels LB1100003/4/5 + LL641CN/3 + LL641CN/3.

#### Finishing

Nero da stampaggio Black Noir moulé	Grigio antracite RAL 7021 Grey anthracite RAL 7021 Gris anthracite RAL 7021
Grigio High Tech RAL 9006 Grey High Tech RAL 9006 Gris High Tech RAL 9006	Cemento grigio Concrete, grey Ciment, gris
Corten Corten Corten	

\* **Led colour**  
N 4000K  
S 3000K, Im -5%

**Completa il codice**  
sostituendo al quadrato rosso la lettera o il numero corrispondente alla temperatura colore scelta.

**Complete the code**  
by replacing the red box with the letter or number corresponding to the selected colour temperature.

**Compléter le code**  
en remplaçant le carré rouge par la lettre ou le numéro correspondant à la sélection de température couleur.

✓ **Alimentatore integrato**  
Integrated driver  
Alimentation intégrée

# Kit Stile next Post

<b>Kit-08 Stile Next Post</b>		<b>DIFF. TRASP.</b>	<b>POSITION</b>															
IP 66 IK 06 1J xx3																		
<b>LED</b>	<b>W</b> <b>LM</b> <b>REAL LM</b>	<b>COL.</b>	<b>CODE *</b> <b>€</b> <b>* LED COLOUR</b>															
3+3	45 + 45		<table border="0"> <tr> <td></td> <td>LL110003</td> <td>293,00</td> <td></td> <td>4000K</td> </tr> <tr> <td></td> <td>LL110015</td> <td>293,00</td> <td></td> <td>3000K, lm -5%</td> </tr> <tr> <td></td> <td>LL110009</td> <td>293,00</td> <td></td> <td></td> </tr> </table>		LL110003	293,00		4000K		LL110015	293,00		3000K, lm -5%		LL110009	293,00		
	LL110003	293,00		4000K														
	LL110015	293,00		3000K, lm -5%														
	LL110009	293,00																

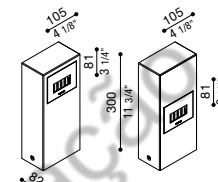

Versione Biemissione. Kit composto dagli attuali codici LB1100003/4/5 + LL643CN/3 + LL643CN/3.

Bidirectional version. Kit consisting of the current codes LB1100003/4/5 + LL643CN/3 + LL643CN/3.

Version bidirectionnelle. Kit composé des codes actuels LB1100003/4/5 + LL643CN/3 + LL643CN/3.

<b>Kit-09 Stile Next Post</b>		<b>DIFF. TRASP.</b>																
IP 66 IK 06 1J xx3																		
<b>LED</b>	<b>W</b> <b>LM</b> <b>REAL LM</b>	<b>COL.</b>	<b>CODE *</b> <b>€</b> <b>* LED COLOUR</b>															
3+3	68 + 45		<table border="0"> <tr> <td></td> <td>LL110004</td> <td>281,00</td> <td></td> <td>4000K</td> </tr> <tr> <td></td> <td>LL110016</td> <td>281,00</td> <td></td> <td>3000K, lm -5%</td> </tr> <tr> <td></td> <td>LL110010</td> <td>281,00</td> <td></td> <td></td> </tr> </table>		LL110004	281,00		4000K		LL110016	281,00		3000K, lm -5%		LL110010	281,00		
	LL110004	281,00		4000K														
	LL110016	281,00		3000K, lm -5%														
	LL110010	281,00																

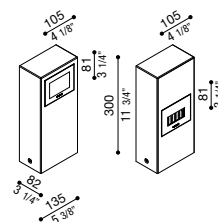

Versione Biemissione. Kit composto dagli attuali codici LB1100003/4/5 + LL641CN/3 + LL643CN/3.

Bidirectional version. Kit consisting of the current codes LB1100003/4/5 + LL641CN/3 + LL643CN/3.

Version bidirectionnelle. Kit composé des codes actuels LB1100003/4/5 + LL641CN/3 + LL643CN/3.

<b>Kit-10 Stile Next Post</b>		<b>DIFF. TRASP.</b>																
IP 66 IK 06 1J xx3																		
<b>LED</b>	<b>W</b> <b>LM</b> <b>REAL LM</b>	<b>COL.</b>	<b>CODE *</b> <b>€</b> <b>* LED COLOUR</b>															
3+3	45 + 68		<table border="0"> <tr> <td></td> <td>LL110005</td> <td>281,00</td> <td></td> <td>4000K</td> </tr> <tr> <td></td> <td>LL110017</td> <td>281,00</td> <td></td> <td>3000K, lm -5%</td> </tr> <tr> <td></td> <td>LL110011</td> <td>281,00</td> <td></td> <td></td> </tr> </table>		LL110005	281,00		4000K		LL110017	281,00		3000K, lm -5%		LL110011	281,00		
	LL110005	281,00		4000K														
	LL110017	281,00		3000K, lm -5%														
	LL110011	281,00																

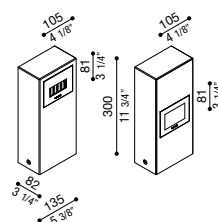

Versione Biemissione. Kit composto dagli attuali codici LB1100003/4/5 + LL643CN/3 + LL641CN/3.

Bidirectional version. Kit consisting of the current codes LB1100003/4/5 + LL643CN/3 + LL641CN/3.

Version bidirectionnelle. Kit composé des codes actuels LB1100003/4/5 + LL643CN/3 + LL641CN/3.

## Finishing

	Nero da stampaggio Black Noir moulé		Grigio antracite RAL 7021 Grey anthracite RAL 7021 Gris anthracite RAL 7021
	Grigio High Tech RAL 9006 Grey High Tech RAL 9006 Gris High Tech RAL 9006		Cemento grigio Concrete, grey Ciment, gris
	Corten Corten Corten		

- Led colour**
- 4000K
- 3000K, lm -5%

**Completa il codice** sostituendo al quadrato rosso la lettera o il numero corrispondente alla temperatura colore scelta.

**Complete the code** by replacing the red box with the letter or number corresponding to the selected colour temperature.

**Compléter le code** en remplaçant le carré rouge par la lettre ou le numéro correspondant à la sélection de température couleur.

- Alimentatore integrato**  
Integrated driver  
Alimentation intégrée



<b>Kit-11 Stile Next Post</b>			<b>DIFF. OPAL.</b>	Fino ad esaurimento. Until our stock lasts. Jusqu'à épuisement de stock.		
<b>IP 66 IK 06 1J xx3 CE UK CA</b>						
LED	W	LM	REAL LM	COL.	CODE *	€ * LED COLOUR
	3	310	68	220-240 V	LL642C854 □	267,00 N 4000K 3 3000K, lm -5%

Kit composto dagli attuali codici LB11854 + LL642CN/3. Kit consisting of the current codes LB11854 + LL642CN/3. Kit composé des codes actuels LB11854 + LL642CN/3.

<b>Kit-12 Stile Next Post</b>			<b>DIFF. TRASP.</b>	Fino ad esaurimento. Until our stock lasts. Jusqu'à épuisement de stock.		
<b>IP 66 IK 06 1J xx3 CE UK CA</b>						
LED	W	LM	REAL LM	COL.	CODE *	€ * LED COLOUR
	3	310	45	220-240 V	LL644C854 □	278,00 N 4000K 3 3000K, lm -5%

Kit composto dagli attuali codici LB11854 + LL644CN/3. Kit consisting of the current codes LB11854 + LL644CN/3. Kit composé des codes actuels LB11854 + LL644CN/3.

**ACCESSORI**

Accessories / Accessoires

**Dima e kit di fissaggio Palo Stile Next**

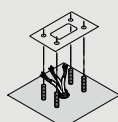

Dima, tirafondi e minuteria per ancoraggio del palo al terreno.

Template and fixing kit for post Stile Next  
Template, fixing bolts and small metal parts to secure the post to the ground.

Gabarit, tire-fond et visserie pour ancrage du poteau Stile Next  
Gabarit, tire-fond et visserie pour ancrage du poteau au sol.

COL.	CODE	€
	LB11255	15,00

**Morsettiere**  
Terminal blocks



**Scaricatori SPD**  
Surge protector devices



# Cemento style

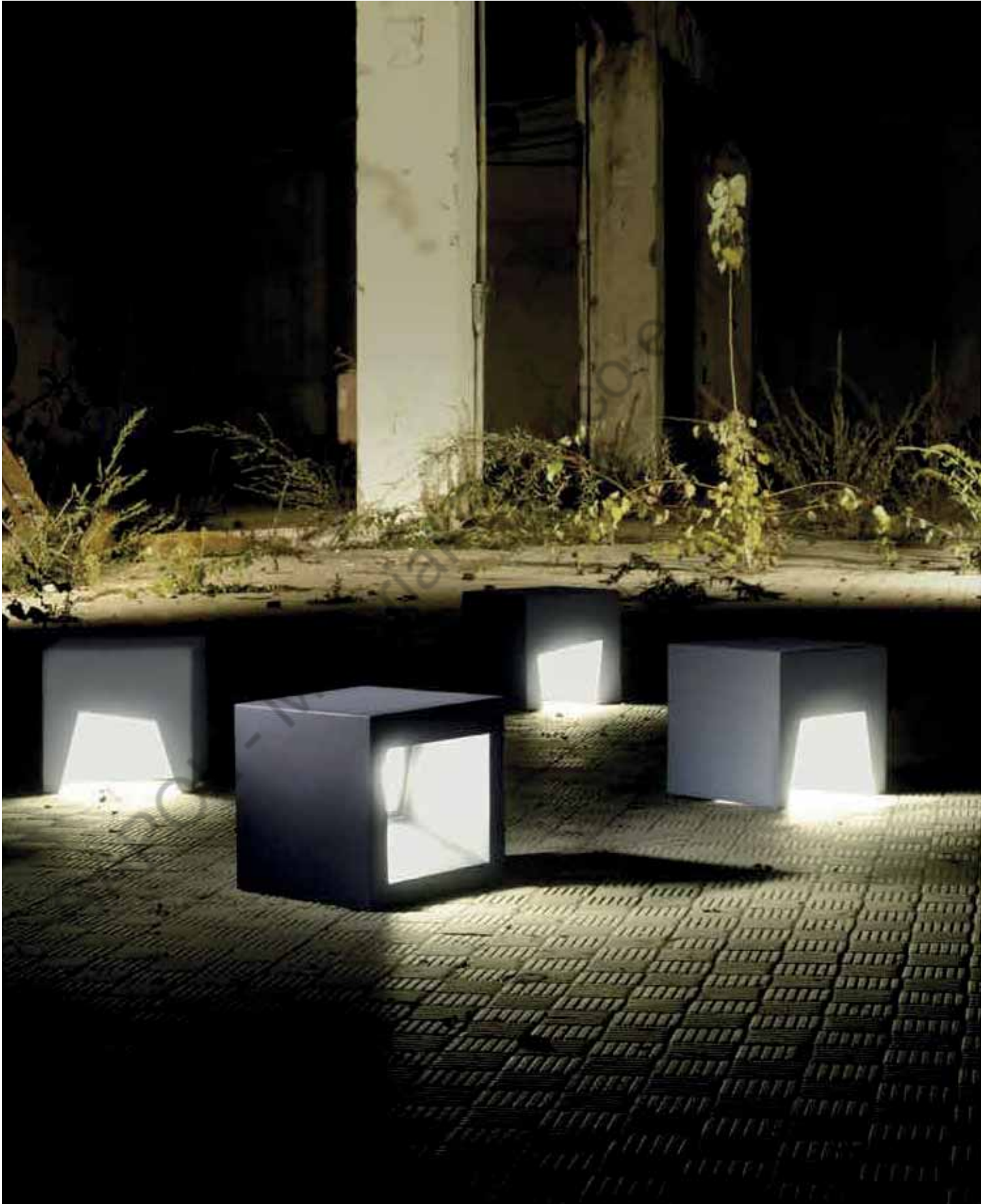





**Cemento Style Modulo A 118**



Apparecchio non incluso. Struttura in cemento per installazione a pavimento con relativa bulloneria. Peso dell'accessorio in cemento con prodotto inserito: 16.5kg. Prodotti associati: Stile Next 103

**Cemento Style - Modulo A 118**  
Lighting fixture not included. Body made of concrete for ground application. Fixing nuts and bolts included. Total weight of the concrete post with product fitted inside: 16.5Kg/36.37Lb. Suitable for fitting with our Stile Next 103.

**Cemento Style - Modulo A 118**  
Appareil non inclus. Structure en ciment pour installation au sol, avec visserie (fixation). Poids brut du support avec bâti inclus: 16.5Kg/36.37Lb. Produits complémentaires: Stile Next 103.

COL.	CODE	€
	LB12114	212,50

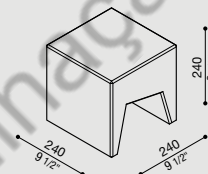

Fino ad esaurimento.  
Until our stock lasts.  
Jusqu'à épuisement de stock.

**Cemento Style Modulo R**



Apparecchio non incluso. Struttura in cemento per installazione a pavimento con relativa bulloneria. Peso dell'accessorio in cemento con prodotto inserito: 13kg. Prodotti associati: Stile Next 103

**Cemento Style - Modulo R**  
Lighting fixture not included. Body made of concrete for ground application. Fixing nuts and bolts included. Total weight of the concrete post with product fitted inside: 13Kg/28.66Lb. Suitable for fitting with our Stile Next 103.

**Cemento Style - Modulo R**  
Appareil non inclus. Structure en ciment pour installation au sol, avec visserie (fixation). Poids brut du support avec bâti inclus: 13Kg/28.66Lb. Produits complémentaires: Stile Next 103.

COL.	CODE	€
	LB12134	212,50

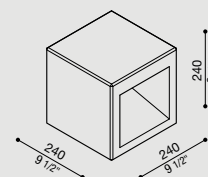

Fino ad esaurimento.  
Until our stock lasts.  
Jusqu'à épuisement de stock.

**Cemento Style 103**



Apparecchio non incluso. Struttura in cemento per installazione a pavimento con relativa bulloneria. Peso dell'accessorio in cemento con prodotto inserito: 2.7kg. Prodotti associati: Stile Next 103 - Stile Next 103 Asimmetrica.

**Cemento Style 103**  
Lighting fixture not included. Body made of concrete for ground application. Fixing nuts and bolts included. Total weight of the concrete post with product fitted inside: 2.7Kg/5.95Lb. Suitable for fitting with our Stile Next 103; Stile Next 103 Asimmetrica.

**Cemento Style 103**  
Appareil non inclus. Structure en ciment pour installation au sol, avec visserie (fixation). Poids brut du support avec bâti inclus: 2.7Kg/5.95Lb. Produits complémentaires: Stile Next 103 - Stile Next 103 Asimmetrica.

COL.	CODE	€
	LB11854	144,00

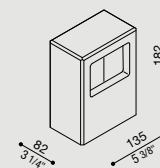

Fino ad esaurimento.  
Until our stock lasts.  
Jusqu'à épuisement de stock.

# Pipeline

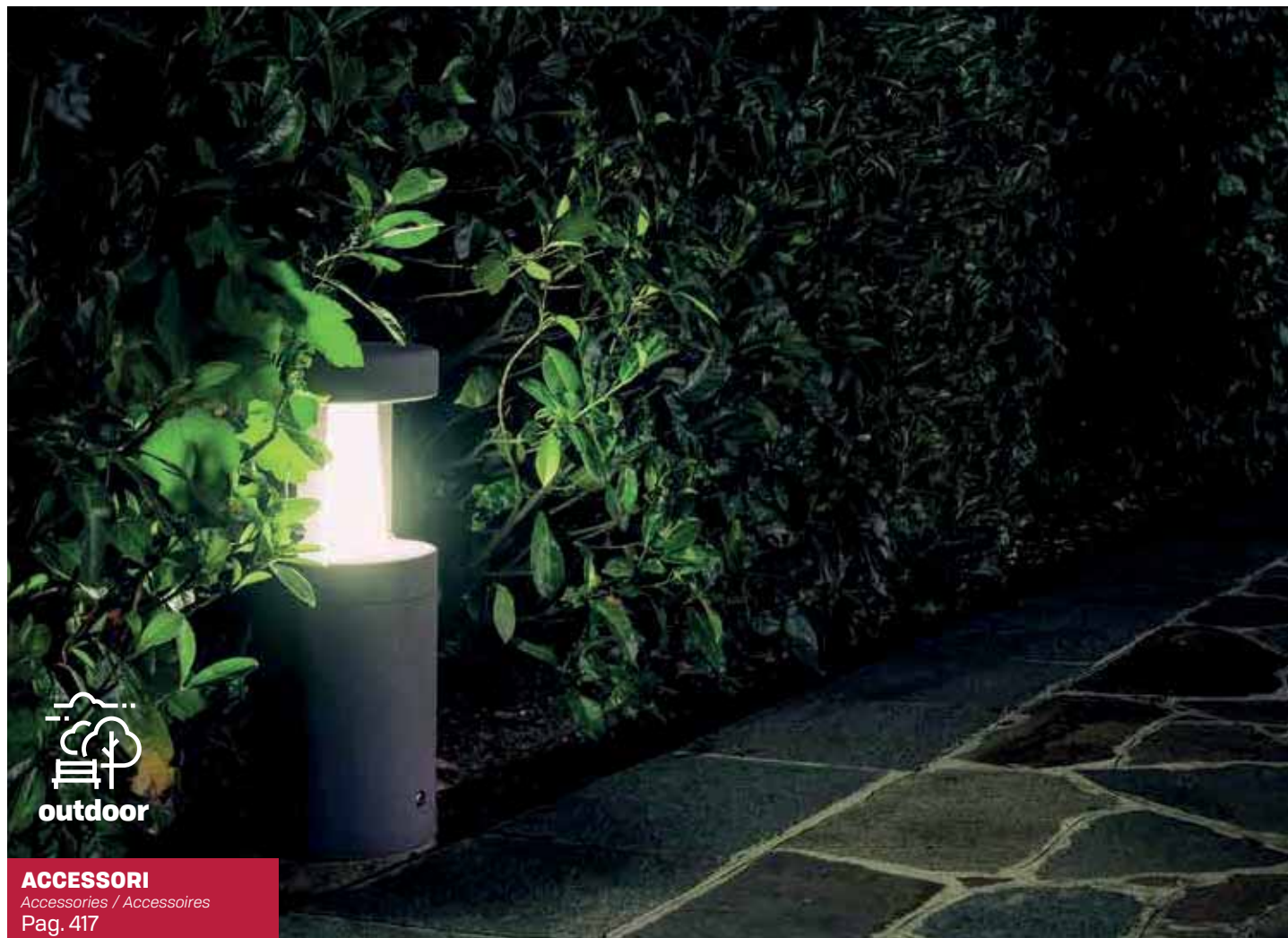

Adatto anche ad uso esterno. Struttura del palo realizzata in cemento, cover superiore in cemento. Corpo illuminante con base e anello in tecnopolimero. Diffusore in polycarbonato tripla stabilizzazione UV, satinato effetto vetro. Guarnizioni in silicone. Bulloneria in acciaio inox A4. Cavo di alimentazione H05RN-F pre-cablato.

**ENG** Also suitable for outdoor use. Post structure made of concrete with concrete top cover. Lighting body with technopolymer base and ring. Polycarbonate diffuser with triple stabilisation against UV rays, satin glass effect. Silicone gaskets. Stainless steel A4 nuts and bolts. Pre-wired cable type H05RN-F.

**FRA** Également adapté à l'usage à l'extérieur. Structure du poteau réalisé en béton, cover supérieur en béton. Luminaire avec base et anneau en technopolymère. Diffuseur en polycarbonate triple stabilisation UV, effet verre dépoli. Joints en silicone. Fixation en acier inox type A4. Câble d'alimentation H05RN-F pré-câblé.

**Pipeline T 90**



**Pipeline T 50**







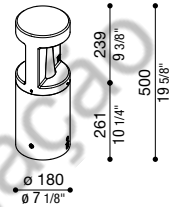

## Pipeline T 50

**DIFF. POLIGLASS**

Fino ad esaurimento.  
Until our stock lasts.  
Jusqu'à épuisement de stock.



**IP 66 IK 07 2J xx5**  

LAMP	ATT.	LAMP MAX	CFL	COL.	CODE	€
	E27	1X33			<b>LB109002</b>	<b>347,00</b>

Versione Biemissione, altezza 50 cm. Cover superiore realizzata in cemento. Idoneo per applicazione a pavimento, bulloneria inclusa. Peso prodotto: 9 Kg. Lampade dim. max: E27 196 mm Ø 58 mm.

*Bidirectional version, height 50 cm. Upper cover made of concrete. Suitable for floor installation, nuts and bolts included. Product weight: 9 Kg/19.84Lb. Lamp dim. max: E27 196 mm Ø 58 mm.*



*Versión bidireccional, altura 50 cm. Cover superior realizada en betón. Adapté pour une application au sol, fixation comprise. Poids produit: 9 kg/19.84Lb. Lampes dim. max: E27 196 mm Ø 58 mm.*

## Pipeline T 90

**DIFF. POLIGLASS**

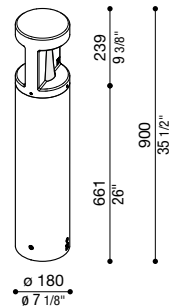
Fino ad esaurimento.  
Until our stock lasts.  
Jusqu'à épuisement de stock.



**IP 66 IK 07 2J xx5**  

LAMP	ATT.	LAMP MAX	CFL	COL.	CODE	€
	E27	1X33			<b>LB109000</b>	<b>403,50</b>

Versione Biemissione, altezza 90 cm. Cover superiore realizzata in cemento. Idoneo per applicazione a pavimento, bulloneria inclusa. Peso prodotto: 16 Kg. Lampade dim. max: E27 196 mm Ø 58 mm.

*Bidirectional version, height 90 cm. Upper cover made of concrete. Suitable for floor installation, nuts and bolts included. Product weight: 16 Kg/35.27Lb. Lamp dim. max: E27 196 mm Ø 58 mm.*

*Versión bidireccional, altura 90 cm. Cover superior realizada en betón. Adapté pour une application au sol, fixation comprise. Poids produit: 16 kg/35.27Lb. Lampes dim. max: E27 196 mm Ø 58 mm.*

### Finishing

 Cemento grigio  
Concrete, grey  
Ciment, gris

### ACCESSORI

Accessories / Accessoires

#### Morsettiera coassiale

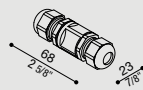

Morsettiera coassiale a 3 poli, IP68, per cavo Ø 7/12 mm.

**Coaxial Terminal block**  
Coaxial 3-pole terminal block,  
IP68, for cable diameter 7/12 mm.

**Bornier coaxial**  
Bornier coaxial à 3 pôles, IP68,  
pour câble diam. 7/12 mm

COL.	CODE	€
	<b>LB11293</b>	<b>15,50</b>

#### Morsettiera lineare a 3 vie

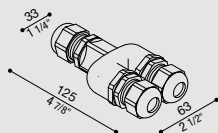

Morsettiera lineare a 3 vie a 3 poli, IP68, per cavo Ø 7/13,5 mm.

**3 way linear terminal block**  
3-way 3-pole linear terminal block,  
IP68, for cable Ø 7/13.5 mm.

**Bornier linéaire 3 voies**  
Bornier linéaire 3 voies à 3 pôles,  
IP68, pour câble diam. 7/13,5 mm

COL.	CODE	€
	<b>LB11294</b>	<b>24,50</b>



# Stile



Adatto anche ad uso esterno. Base in policarbonato e diffusore in vetro temprato. Riflettore in alluminio tipo L2-1060. Guarnizioni in silicone. Doppio pressacavo PG 13 + tappo di chiusura per singola alimentazione. Viti imperdibili in acciaio inox A4 a testa esagonale ch.3. **LED 4000K (N) o 3000K (3). Alimentazione diretta 220-240V. Nessun rischio fotobiologico, RG0 gruppo di rischio esente (EN62471).**

**ENG** Suitable for outdoor use. Polycarbonate base and tempered glass diffuser. Reflector made of aluminium type L2-1060. Silicone gaskets. PG 13 double cable gland + cover for single power supply. A4 stainless steel captive hex screws size 3 mm. **LED 4000K (N) or 3000K (3) LED. Integral ballast 220-240V. No risk of photobiological damage, RG0 group (EN62471).**

**FRA** Egalement adapté à l'usage à l'extérieur. Base en polycarbonate et diffuseur en verre trempé. Réflecteur en aluminium type L2-1060. Joints en silicone. Double serre-câble PG 13 + bouchon de fermeture pour alimentation simple. Vis six pans creux ch. 3 en acier inox type A4. **LED 4000K (N) ou 3000K (3) (blanche chaude). Alimentation intégrée 220-240. Pas de risque photobiologique, RG0 groupe (EN62471).**

**Stile 330 simmetrica**



**Stile 260 simmetrica**



## Finishing

	Nero da stampaggio Black Noir moulé		Corten Corten Corten
	Grigio High Tech RAL 9006 Grey High Tech RAL 9006 Gris High Tech RAL 9006		



### Stile 260 simmetrica

DIFF.  
VETRO

IP 66 IK 08 5J xx7 CE UK CA

LED	W	LM	REAL LM	COL.	CODE *	€	* LED COLOUR
	10	1300	386		LL781E2□	100,00	N 4000K
					LL781EG□	100,00	S 3000K, lm -5%
					LL781EK□	100,00	
LAMP	ATT.	LAMP MAX	CFL	COL.	CODE *	€	
	E27	1x20			LB78122	83,00	
					LB7812G	83,00	
					LB7812K	83,00	

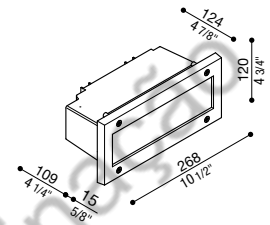

Anello in VALOX 4512. Lampade dim. max: E27 145 mm Ø 48 mm.

Frame made of VALOX 4512.  
Lamp max. dim: E27 145 mm Ø 48 mm.

Anneau en VALOX 4512.  
Lampes dim. max: E27 145 mm Ø 48 mm

### Stile 330 simmetrica

DIFF.  
VETRO

IP 66 IK 08 5J xx7 CE UK CA

LED	W	LM	REAL LM	COL.	CODE *	€	* LED COLOUR
	15	1900	764		LL791G2□	111,50	N 4000K
					LL791GG□	111,50	S 3000K, lm -5%
					LL791GK□	111,50	
LAMP	ATT.	LAMP MAX	CFL	COL.	CODE *	€	
	E27	1X33			LB79122	94,50	
					LB7912G	94,50	
					LB7912K	94,50	

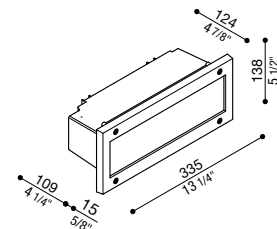

Anello in VALOX 4512. Lampade dim. max: E27 196 mm Ø 58 mm.

Frame made of VALOX 4512.  
Lamp max. dim: E27 196 mm Ø 58 mm.

Anneau en VALOX 4512.  
Lampes dim. max: E27 196 mm Ø 58 mm.

## ACCESSORI

Accessories / Accessoires

#### Armatura da incasso Stile 260 Stile Next 260

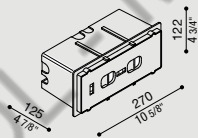

Armatura da incasso in termoplastico.

Thermoplastic recess box Stile 260 - Stile Next 260  
Thermoplastic recess box.

Armature à encastrer Stile 260 / Stile Next 260  
Armature à encastrer en matériau thermoplastique.

COL.	CODE	€
	LB11530	11,50

#### Cassaforma Polistirolo Stile 260 Stile Next 260

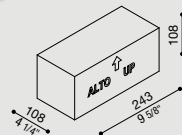

Cassaforma in polistirolo.

Polystyrene mould Stile 260 - Stile Next 260  
Polystyrene mould.

Gabarit en polystyrène Stile 260 / Stile Next 260  
Gabarit en polystyrène.

COL.	CODE	€
	LB11550	1,50

#### Armatura da incasso Stile 330

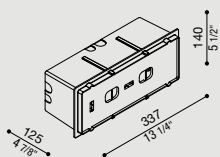

Armatura da incasso in termoplastico.

Thermoplastic recess box Stile 330  
Thermoplastic recess box.

Armature à encastrer Stile 330  
Armature à encastrer en matériau thermoplastique.

COL.	CODE	€
	LB11540	11,50

#### Cassaforma Polistirolo Stile 330

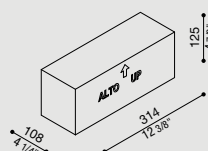

Cassaforma in polistirolo.

Polystyrene mould Stile 330  
Polystyrene mould.

Gabarit en polystyrène Stile 330  
Gabarit en polystyrène.

COL.	CODE	€
	LB11560	1,50

Morsettiere  
Terminal blocks



Scaricatori SPD  
Surge protector devices





# Airy

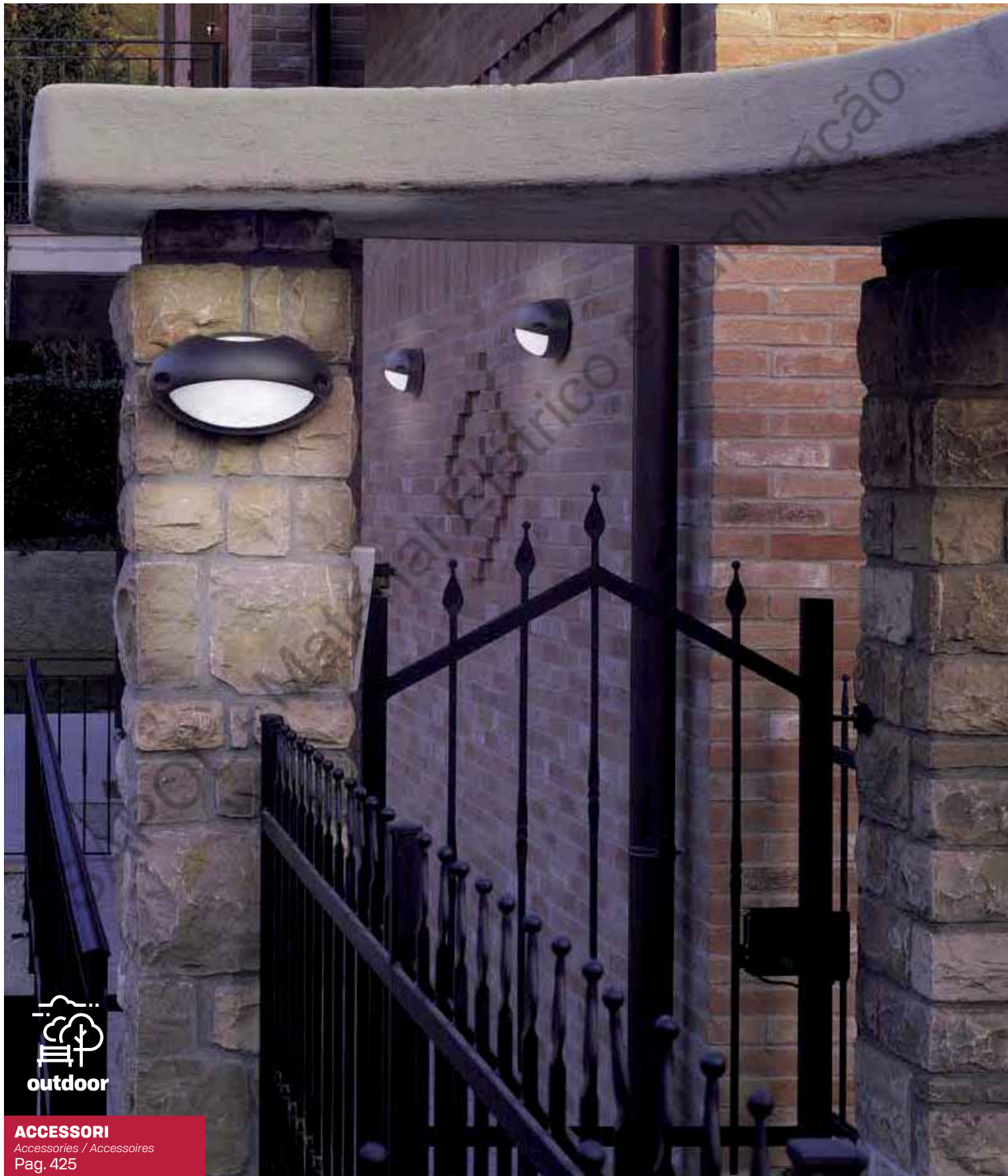



Adatto anche ad uso esterno.  
 Riflettore in alluminio tipo L2-1060.  
 Guarnizione in silicone.  
 Viti in acciaio inox A4.  
 Predisposizione ingresso tubo rigido 16/20 mm.

**Nessun rischio fotobiologico, RGO gruppo di rischio esente (EN62471).**

**ENG** Suitable for indoor and outdoor use.  
 Reflector made of aluminium type L2-1060.  
 Silicone gasket.  
 A4 stainless steel screws.  
 Cable entry option on the side with rigid tube 16/20 mm.  
 No risk of photobiological damage, RGO group (EN62471).

**FRA** Egalement adapté à l'usage à l'extérieur.  
 Réflecteur en aluminium type L2-1060.  
 Joint en silicone. Vis inox type A4.  
 Possibilité d'entrée avec un tube rigide 16/20 mm.  
 Pas de risque photobiologique, RGO groupe (EN62471).

Disponibili versioni a led.  
 Led versions available.  
 Versions led disponibles.

**Airy tonda 300**

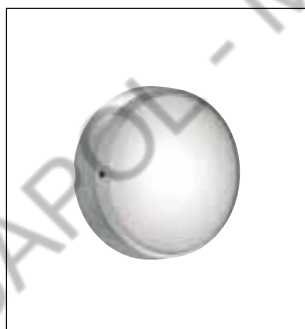

**Airy plus tonda 300**



**Airy top tonda 300**



**Airy plus top tonda 300**



**Airy ovale 300**

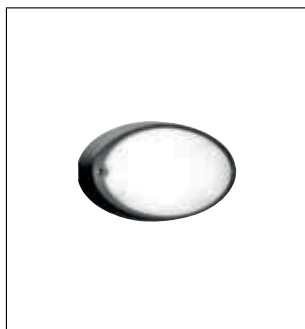

**Airy plus ovale 300**



**Airy top ovale 300**



**Airy plus top ovale 300**



# Airy

## Airy tonda 300

DIFF.  
VETRO

IP 54 IK 06 1J xx3 CE UK  
CA

LAMP	ATT.	LAMP MAX	CFL	COL.	CODE	€
	E27	1x100	1x23		LB82221	50,00
					LB82222	50,00
					LB8222G	65,50

Base e anello in tecnopolimero e diffusore in vetro acidato.  
Lampade dim. max: E27 152 mm Ø 48 mm.

Technopolymer base and ring and acid-etched glass diffuser.  
Lamp max. dim: E27 152 mm Ø 48 mm.

Base et anneau en technopolymère et diffuseur en verre acidé.  
Lampes dim. max: E27 152 mm Ø 48 mm.

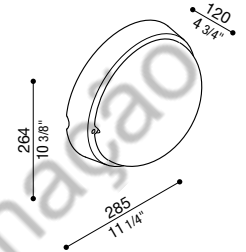

## Airy plus tonda 300

DIFF.  
OPAL.

DIFF.  
SEMITRASP.

IP 65 IK 10 20J xx9 CE UK  
CA

LAMP	ATT.	LAMP MAX	CFL	COL.	CODE	CODE	€
	E27	1x75	1x23		LB85121	LB85221	57,00
					LB85122	LB85222	57,00
					LB8512G	LB8522G	70,00

Base e diffusore in policarbonato, anello in tecnopolimero.  
Lampade dim. max: E27 152 mm Ø 48 mm.

Polycarbonate base and diffuser, technopolymer ring.  
Lamp max. dim: E27 152 mm Ø 48 mm.

Base et diffuseur en polycarbonate, anneau en technopolymère.  
Lampes dim. max: E27 152 mm Ø 48 mm.

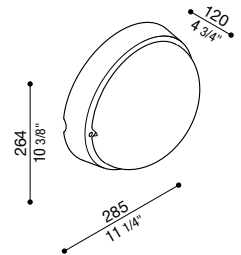

## Airy top tonda 300

DIFF.  
VETRO

IP 54 IK 06 1J xx3 CE UK  
CA

LAMP	ATT.	LAMP MAX	CFL	COL.	CODE	€
	E27	1x100	1x23		LB82721	57,00
					LB82722	57,00
					LB8272G	74,00

Base e visiera in tecnopolimero e diffusore in vetro acidato.  
Lampade dim. max: E27 152 mm Ø 48 mm

Technopolymer base and eyelid and acid-etched glass diffuser.  
Lamp max. dim: E27 152 mm Ø 48 mm

Base et casquette en technopolymère et diffuseur en verre acidé.  
Lampes dim. max: E27 152 mm Ø 48 mm

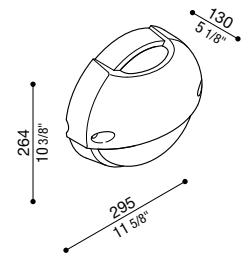

### Finishing

Bianco da stampaggio  
White  
Blanc moulé  
 Nero da stampaggio  
Black  
Noir moulé

Grigio High Tech RAL 9006  
Grey High Tech RAL 9006  
Gris High Tech RAL 9006



### Airy plus top tonda 300

DIFF. OPAL.

DIFF. SEMITRASP.

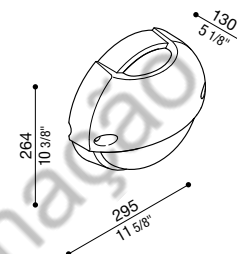

IP 65 IK 10 20J xx9 CE UK CRA

LAMP	ATT.	LAMP MAX	CFL	COL.	CODE	CODE	€
E27	1x75	1x20	☐	■	LB85321	LB85421	64,50
					LB85322	LB85422	64,50
					LB8532G	LB8542G	80,50

Base e diffusore in policarbonato, visiera in tecnopolimero. Lampade dim. max: E27 152 mm Ø 48 mm

Polycarbonate base and diffuser, technopolymer eyelid. Lamp max. dim: E27 152 mm Ø 48 mm

Base et diffuseur en polycarbonate, casquette en technopolymère. Lampes dim. max: E27 152 mm Ø 48 mm

### Airy ovale 300

DIFF. VETRO

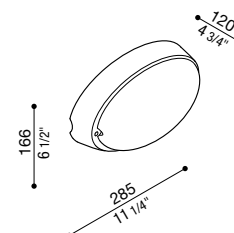

IP 54 IK 06 1J xx3 CE UK CRA

LAMP	ATT.	LAMP MAX	CFL	COL.	CODE	€
E27	1x60	1x23	☐	■	LB82121	35,50
					LB82122	35,50
					LB8212G	48,00

Base e anello in tecnopolimero e diffusore in vetro acidato. Lampade dim. max: E27 152 mm Ø 48 mm

Technopolymer base and ring and acid-etched glass diffuser. Lamp max. dim: E27 152 mm Ø 48 mm

Base et anneau en technopolymère et diffuseur en verre acidé. Lampes dim. max: E27 152 mm Ø 48 mm

### Airy plus ovale 300

DIFF. OPAL.

DIFF. SEMITRASP.

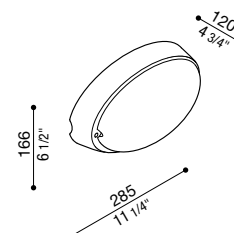

IP 65 IK 10 20J xx9 CE UK CRA

LAMP	ATT.	LAMP MAX	CFL	COL.	CODE	CODE	€
E27	1x60	1x23	☐	■	LB84121	LB84221	43,00
					LB84122	LB84222	43,00
					LB8412G	LB8422G	54,00

Base e diffusore in policarbonato, anello in tecnopolimero. Lampade dim. max: E27 152 mm Ø 48 mm

Polycarbonate base and diffuser, technopolymer ring. Lamp max. dim: E27 152 mm Ø 48 mm

Base et diffuseur en polycarbonate, anneau en technopolymère. Lampes dim. max: E27 152 mm Ø 48 mm



# Airy

<b>Airy top ovale 300</b>				<b>DIFF. VETRO</b>		
<b>IP 54 IK 06 1J xx3</b>						
<b>LAMP</b>	<b>ATT.</b>	<b>LAMP MAX</b>	<b>CFL</b>	<b>COL.</b>	<b>CODE</b>	<b>€</b>
	E27	1x60	1x23		<b>LB82321</b>	<b>42,00</b>
					<b>LB82322</b>	<b>42,00</b>
					<b>LB8232G</b>	<b>56,00</b>

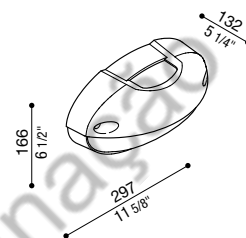

Base e visiera in tecnopolimero e diffusore in vetro acidato.  
Lampade dim. max: E27 152 mm Ø 48 mm

Technopolymer base and eyelid and acid-etched glass diffuser.  
Lamp max. dim: E27 152 mm Ø 48 mm

Base et casquette en technopolymère et diffuseur en verre acide.  
Lampes dim. max: E27 152 mm Ø 48 mm

<b>Airy plus top ovale 300</b>				<b>DIFF. OPAL.</b>		<b>DIFF. SEMITRASP.</b>	
<b>IP 65 IK 10 20J xx9</b>							
<b>LAMP</b>	<b>ATT.</b>	<b>LAMP MAX</b>	<b>CFL</b>	<b>COL.</b>	<b>CODE</b>	<b>CODE</b>	<b>€</b>
	E27	1x60	1x23		<b>LB84321</b>	<b>LB84421</b>	<b>49,00</b>
					<b>LB84322</b>	<b>LB84422</b>	<b>49,00</b>
					<b>LB8432G</b>	<b>LB8442G</b>	<b>62,00</b>

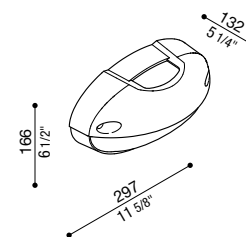

Base e diffusore in policarbonato, visiera in tecnopolimero.  
Lampade dim. max: E27 152 mm Ø 48 mm

Polycarbonate base and diffuser, technopolymer eyelid.  
Lamp max. dim: E27 152 mm Ø 48 mm

Base et diffuseur en polycarbonate, casquette en technopolymère.  
Lampes dim. max: E27 152 mm Ø 48 mm



## Finishing

Bianco da stampaggio  
White  
Blanc moulé

Grigio High Tech RAL 9006  
Grey High Tech RAL 9006  
Gris High Tech RAL 9006

Nero da stampaggio  
Black  
Noir moulé





**ACCESSORI**

Accessories / Accessoires

**Still**

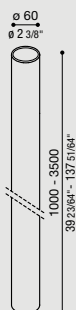

Palo diametro 60 mm in Bayblend senza basamento.  
Possibilità di installazione con o senza basamento.  
Anima interno palo in acciaio zincato per altezze da 2000 mm.

**Still**  
60 mm Bayblend pole without base.  
Possibility of installation with or without base.  
Galvanized steel inner pole from H 2000 mm.

**Still**  
Poteau de 60 mm en Bayblend sans socle.  
Possibilité d'installation avec ou sans socle.  
Noyau interne en acier galvanisé pour poteau à partir de h. 2000 mm.

H 160 mm			H 1000 mm			H 2000 mm			H 3000 mm		
COL.	CODE	€	COL.	CODE	€	COL.	CODE	€	COL.	CODE	€
	LB11033	10,50		LB1100012	13,00		LB1100032	36,50		LB1100052	52,00
	LB1103G	34,50		LB110001G	42,50		LB110003G	92,00		LB110005G	135,00
	LB1103E	34,50		LB110001E	42,50		LB110003E	92,00		LB110005E	135,00
	LB1103K	34,50		LB110001K	42,50		LB110003K	92,00		LB110005K	135,00
	LB11031	34,50		LB110001W	42,50		LB1100031	92,00		LB1100051	135,00

H 500 mm			H 1500 mm			H 2500 mm			H 3500 mm		
COL.	CODE	€	COL.	CODE	€	COL.	CODE	€	COL.	CODE	€
	LB11112	12,00		LB1100022	20,00		LB1100042	47,00		LB1100062	62,50
	LB1111G	38,50		LB110002G	63,50		LB110004G	114,00		LB110006G	156,50
	LB1111E	38,50		LB110002E	63,50		LB110004E	114,00		LB110006E	156,50
	LB1111K	38,50		LB110002K	63,50		LB110004K	114,00		LB110006K	156,50
	LB11111	38,50		LB1100021	63,50		LB1100041	114,00		LB1100061	156,50

**Adattatore Palo Still Ø60**

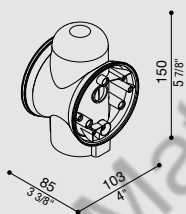

Adattatore diametro 60 mm. in policarbonato con tappo di chiusura per eventuale utilizzo con un solo punto luce.

**Adaptor for Still Post Ø 60**  
Polycarbonate adaptor diameter 60 mm.  
With blanking cap for single fixture use (one luminaire).

**Adaptateur poteau Still Ø60**  
Adaptateur diam. 60 mm en polycarbonate avec bouchon de fermeture pour utilisation avec une seule sortie (un seul point lumière).

COL.	CODE	€
	LB11312	12,50
	LB1131G	18,50
	LB1131K	25,00

**Basamento Palo Still Ø170 mm**

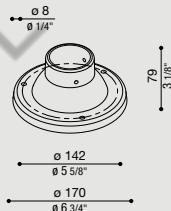

Basamento in nylon-fibra di vetro per palo diametro 60 mm.

**Base Ø170 mm for Still post**  
Base in fibreglass-nylon for post diameter 60 mm.

**Socle Ø170 mm pour poteau Still**  
Socles en fibre de verre - nylon pour poteau diam.60 mm

COL.	CODE	€
	LB11812	22,00
	LB1181G	34,00
	LB1181E	34,00
	LB1181K	34,00
	LB11811	34,00

**Piastra base a scomparsa palo Still**

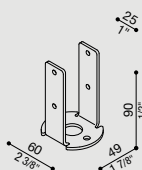

Soluzione alternativa al tradizionale interrimento o al basamento palo still mediante staffa di fissaggio a scomparsa. Consiste nell'inserire il palo still sulla staffa preforata da 3mm, realizzata in ferro zincato a caldo per immersione. Accessorio non idoneo per pali still superiori a h. 1500mm.

**Retractable plate base**  
Alternative solution to the usual burial or to the post base using a retractable fixing bracket.  
The post is inserted in the 3mm pre-drilled bracket made of hot-dip zinc-coated metal.  
Accessory not suitable for posts higher than 1500mm.

**Plaque de base rétractable**  
Solution alternative à l'enfouissement traditionnel ou mise en place moyennant un étrier de fixation rétractable du pieu post.  
Insérer le poteau Still sur l'étrier pré-percé de 3 mm, réalisé en fer galvanisé à chaud par immersion.  
Accessoire ne convenant pas à des poteaux Still de plus de 1500mm de haut.

COL.	CODE	€
	LB1130006	14,00



## ACCESSORI

Accessories / Accessoires

### Dima e kit di fissaggio Palo Still

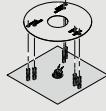

Dima, tirafondi e minuteria per ancoraggio del basamento al terreno.

**Template and fixing kit Still Post diam. 60 mm.**

Template, fixing bolts and small metal parts to secure the base to the ground.

**Gabarit, tire-fond et visserie pour poteau Still**

Gabarit, tire-fond et visserie pour l'ancrage du socle au sol.

COL.	CODE	€
	<b>LB11254</b>	<b>13,00</b>

### Braccetto Airy Tonda

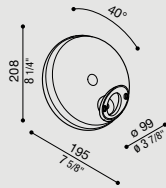

Kit in policarbonato composto da supporto (A) e copertura apparecchio (B). Possibilità di montaggio a parete o su palo (inclinato di 40° o in asse al palo). Braccetto per apparecchi tondi.

**Bracket Airy Tonda**

Kit comprised of support (A) and fitting plate (B), both in polycarbonate.

Wall or post mounting (angled at 40° or vertical to the post). Bracket for round luminaires.

**Bras Airy Tonda**

Kit en polycarbonate composé du support (A) et couverture appareil (B).

Possibilité de montage au mur ou sur poteau (Incliné à 40° ou centre par rapport au poteau). Bras pour appareils ronds.

COL.	CODE	€
	<b>LB11442</b>	<b>17,50</b>
	<b>LB1144G</b>	<b>33,00</b>
	<b>LB1144K</b>	<b>38,50</b>

### Braccetto Airy Ovale

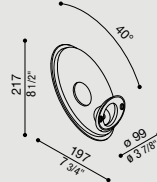
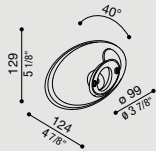

Kit in policarbonato composto da supporto (A) e copertura apparecchio (B). Possibilità di montaggio verticale o orizzontale a parete o su palo (inclinato di 40° o in asse al palo). Braccetto per apparecchi ovali.

**Bracket Airy Ovale**

Kit comprised of support (A) and fitting plate (B), both in polycarbonate. Wall or post mounting (angled at 40° or vertical to the post), both vertically and horizontally. Bracket for oval luminaires.

**Bras Airy Ovale**

Kit en polycarbonate composé du support (A) et couverture appareil (B).

Possibilité de montage au mur vertical ou horizontal, ou sur poteau (Incliné à 40° ou centre par rapport au poteau). Bras pour appareils ovales.

COL.	CODE	€
	<b>LB11432</b>	<b>15,50</b>
	<b>LB1143G</b>	<b>27,00</b>
	<b>LB1143K</b>	<b>34,00</b>





# Nova / Class



LED



indoor



outdoor

**ACCESSORI**

Accessories / Accessoires

Pag. 432



Adatto anche ad uso esterno.

Base e anello/visiera in policarbonato.

Riflettore in policarbonato o alluminio tipo L2-1060.

Predisposizione ingresso tubo rigido 16/20 mm.

Chiusura/apertura diffusore senza utensili.

**LED 4000K (N) o 3000K (3). Alimentazione diretta 220-240V.**

**Nessun rischio fotobiologico, RGO gruppo di rischio esente (EN62471).**

**ENG** Suitable for indoor and outdoor use.

Polycarbonate base and ring/eyelid.

Reflector made of polycarbonate or aluminium type L2-1060.

Cable entry option on the side with rigid tube 16/20 mm.

The diffuser can be opened/closed without the need for tools.

**LED 4000K (N) or 3000K (3). Integral ballast 220-240V.**

**No risk of photobiological damage, RGO group (EN62471).**

**FRA** Également adapté à l'usage à l'extérieur.

Base et anneau/casquette en polycarbonate.

Réflecteur en polycarbonate ou aluminium type L2-1060.

Possibilité d'entrée avec un tube rigide 16/20 mm.

Fermeture/ouverture du diffuseur sans outils.

**LED 4000K (N) ou 3000K (3) (blanche chaude). Alimentation intégrée 220-240.**

**Pas de risque photobiologique, RGO groupe (EN62471).**

**Nova tonda 330**



**Class tonda 330**



**Nova tonda 260**



**Class tonda 260**



**Anni di garanzia  
sul circuito LED**

Years warranty on LED circuit

Ans de garantie sur la source LED



# Nova / Class

## Nova tonda 330

DIFF.  
VETRO

Fino ad esaurimento.  
Until our stock lasts.  
Jusqu'à épuisement de stock.

IP 44 IK 07 2J xx5 CE UK  
CA

LED	W	LM	REAL LM		COL.	CODE *	€	* LED COLOUR
18	1950	1530	220-240 V	✓	█	LL812D1	138,00	N 4000K 3 3000K, lm -5%
						LL812D2	138,00	
						LL812DG	156,50	
18	1950	1530	220-240 V	✓	█	LL812R1	232,50	
						LL812R2	232,50	
						LL812RG	246,50	
18	1950	1530	220-240 V	✓	█	LS812D1	182,50	
						LS812D2	182,50	
						LS812DG	198,50	
LAMP	ATT.	LAMP MAX	CFL					
E27	1x100	1x33	NOT INC.	ⓘ	█	LB81221	79,50	
						LB81222	79,50	
						LB8122G	114,50	
E27	2x60	2x30	ⓘ	ⓘ	█	LB812M1	84,00	
						LB812M2	84,00	
						LB812MG	119,00	

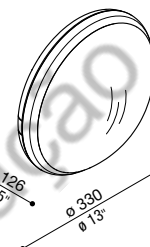

Diffusore in vetro acidato. Lampade dim. max: E27 196 mm Ø 58 mm. Versione doppia: lampade dim. max: E27 180 mm Ø 58 mm.

Acid-etched glass diffuser.  
Lamp max. dim: E27 196 mm Ø 58 mm.  
Double version: Lamp max. dim: E27 180 mm Ø 58 mm.

Diffuseur en verre acidé.  
Lampes dim. max: E27 196 mm Ø 58 mm.  
Version double - Lampes dim. max: E27 180 mm Ø 58 mm.

## Nova tonda 260

DIFF.  
VETRO

Fino ad esaurimento.  
Until our stock lasts.  
Jusqu'à épuisement de stock.

IP 44 IK 06 1J xx3 CE UK  
CA

LED	W	LM	REAL LM		COL.	CODE *	€	* LED COLOUR
18	1950	1515	220-240 V	✓	█	LL802P1	126,50	N 4000K 3 3000K, lm -5%
						LL802P2	126,50	
						LL802PG	139,00	
18	1950	1515	220-240 V	✓	█	LS802P1	171,00	
						LS802P2	171,00	
						LS802PG	184,50	
18	1950	1515	220-240 V	✓	█	LL802R1	274,50	
						LL802R2	274,50	
						LL802RG	296,50	
LAMP	ATT.	LAMP MAX	CFL					
E27	1x75	1x15	NOT INC.	ⓘ	█	LB80221	51,50	
						LB80222	51,50	
						LB8022G	65,50	

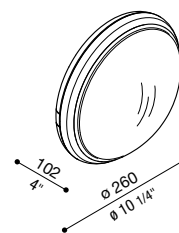

Diffusore in vetro acidato. Lampade dim. max: E27 128 mm Ø 48 mm.

Acid-etched glass diffuser.  
Lamp max. dim: E27 128 mm Ø 48 mm.

Diffuseur en verre acidé.  
Lampes dim. max: E27 128 mm Ø 48 mm.



**Class tonda 330**

DIFF.  
OPAL.

DIFF.  
SEMITRASP.

IP 65 IK 10 20J xx9 CE UK CA

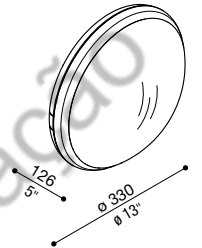

LED	W	LM	REAL LM		COL.	CODE *	CODE *	€	* LED COLOUR
18	1950	1256-1701	220-240 V	☑	LL581Q1	LL582Q1	122,50	N 4000K B 3000K, lm -5%	
					LL581Q2	LL582Q2	122,50		
					LL581QG	LL582QG	140,00		
18	1950	1256-1701	220-240 V	☑	LL581B1	LL582B1	216,50	3H	
					LL581B2	LL582B2	216,50		
					LL581BG	LL582BG	232,50		
18	1950	1256	220-240 V	☑	LS581Q1		165,00	INCLUDED	
					LS581Q2		165,00		
					LS581QG		181,50		
LAMP	ATT.	LAMP MAX	CFL						
E27	1x100	1x33	NOT INC.	☑	LB58121	LB58221	67,50		
					LB58122	LB58222	67,50		
					LB5812G	LB5822G	104,00		
E27	2x60	2x30	☑	☑	LB581M1	LB582M1	74,00		
					LB581M2	LB582M2	74,00		
					LB581MG	LB582MG	109,50		

Diffusore in policarbonato. Guarnizione in silicone.  
Lampade dim. max: E27 196 mm Ø 58 mm.  
Versione doppia: lampade dim. max: E27 180 mm Ø 58 mm.

Polycarbonate diffuser. Silicone gasket.  
Lamp max. dim: E27 196 mm Ø 58 mm.  
Double version: Lamp max. dim: E27 180 mm Ø 58 mm



Diffuseur en polycarbonate. Joint en silicone.  
Lampes dim. max: E27 196 mm Ø 58 mm.  
Version double - Lampes dim. max: E27 180 mm Ø 58 mm.

SAPOL - Material

# Nova / Class

## Class tonda 260

IP65 IK10 20J xx9 CE UK CRA

LED	W	LM	REAL LM	COL.	CODE *	CODE *	€	* LED COLOUR
18	1950	1223-1658	☑️ 220-240 V		LL591P1☐	LL592P1☐	108,50	N 4000K
					LL591P2☐	LL592P2☐	108,50	3 3000K, lm -5%
					LL591PG☐	LL592PG☐	121,00	
18	1950	1223	☑️ 220-240 V 		LL591B1☐		267,50	
					LL591B2☐		267,50	
					LL591BG☐		286,00	
18	1950	1223	☑️ 220-240 V 		LS591P1☐		153,50	
					LS591P2☐		153,50	
					LS591PG☐		165,00	
LAMP	ATT.	LAMP MAX	CFL					
E27	1x75	1x15	☑️ 		LB59121	LB59221	52,50	
					LB59122	LB59222	52,50	
					LB5912G	LB5922G	69,00	

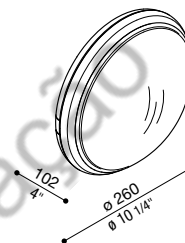



Diffusore in policarbonato. Guarnizione in silicone. Lampade dim. max: E27 128 mm Ø 48 mm.

Polycarbonate diffuser. Silicone gasket. Lamp max. dim: E27 128 mm Ø 48 mm.

Diffuseur en polycarbonate. Joint en silicone. Lampes dim. max: E27 128 mm Ø 48 mm.

### Finishing

	Bianco da stampaggio White Blanc moulé		Grigio High Tech RAL 9006 Grey High Tech RAL 9006 Gris High Tech RAL 9006
	Nero da stampaggio Black Noir moulé		

### \* Led colour

- N 4000K
- 3 3000K, lm -5%

**Completa il codice**  
sostituendo al quadrato rosso la lettera o il numero corrispondente alla temperatura colore scelta.

**Complete the code**  
by replacing the red box with the letter or number corresponding to the selected colour temperature.

**Compléter le code**  
en remplaçant le carré rouge par la lettre ou le numéro correspondant à la sélection de température couleur.

### ✓ Alimentatore integrato Integrated driver Alimentation intégrée

## ACCESSORI

Accessories / Accessoires

### Sensore di Movimento

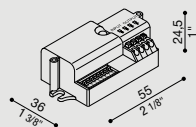

Kit di montaggio per sensore di movimento crepuscolare.  
Per la versione E27 è consigliabile l'utilizzo di lampadine FTB ad accensione illimitata (ON/OFF unlimited).

**Motion sensor**  
Mounting kit for motion sensor (which may be mounted inside the fixture).  
For E27 version we recommend the use of "on/off unlimited" FTP lamps.

**Détecteur de présence**  
Kit de montage pour détecteur de mouvement crépusculaire.  
Pour la version E27 il est conseillé d'utiliser l'appareil avec des lampes FTB de type on/off illimité (ON/OFF unlimited).

COL.	CODE	€
	LB11295	48,00

**Morsettiere**  
Terminal blocks



**Scaricatori SPD**  
Surge protector devices





Montaggio e smontaggio senza utensili.  
 Opening / closing of the diffuser without tools.  
 Montage et démontage sans outils.







# Green



Adatto anche ad uso esterno. Diffusore in policarbonato. Top in tecnopolimero. Riflettore in alluminio tipo L2-1060. Guarnizioni in silicone. Bulloneria in acciaio inox A4. Cavo di alimentazione H05RN-F pre-cablato.

**ENG** Suitable for outdoor use. Polycarbonate diffuser. Technopolymer top. Reflector made of aluminium type L2-1060. Silicone gaskets. A4 stainless steel nuts and bolts. H05RN-F pre-wired cable.

**FRA** Egalement adapté à l'usage à l'extérieur. Diffuseur en polycarbonate. Partie supérieure en technopolymère. Réflecteur en aluminium type L2-1060. Joints en silicone. Visserie en acier inox type A4. Câble d'alimentation H05RN-F pré-câblé.

<b>Green</b>		<b>DIFF. TRASP.</b>				
<b>IP 66 IK 08 5J xx7</b>   						
LAMP	ATT.	LAMP MAX	CFL	COL.	CODE	€
	E27	1x75	1x33		LB12622	54,00

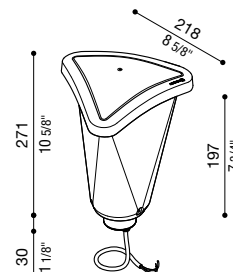

Lampade dim. max: E27196 mm Ø 58 mm

Lamp max. dim: E27196 mm Ø 58 mm

Lampes dim. max: E27196 mm Ø 58 mm

## Finishing

 Nero da stampaggio  
Black  
Noir moulé





**ACCESSORI**  
Accessories / Accessoires

**Still**

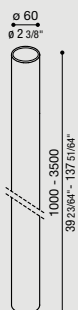

Palo diametro 60 mm in Bayblend senza basamento.  
Possibilità di installazione con o senza basamento.  
Anima interno palo in acciaio zincato per altezze da 2000 mm.

**Still**  
60 mm Bayblend pole without base.  
Possibility of installation with or without base.  
Galvanized steel inner pole from H 2000 mm.

**Still**  
Poteau de 60 mm en Bayblend sans socle.  
Possibilité d'installation avec ou sans socle.  
Noyau interne en acier galvanisé pour poteau à partir de h. 2000 mm.

H 160 mm			H 1000 mm			H 2000 mm			H 3000 mm		
COL.	CODE	€	COL.	CODE	€	COL.	CODE	€	COL.	CODE	€
	LB11033	10,50		LB1100012	13,00		LB1100032	36,50		LB1100052	52,00
	LB1103G	34,50		LB110001G	42,50		LB110003G	92,00		LB110005G	135,00
	LB1103E	34,50		LB110001E	42,50		LB110003E	92,00		LB110005E	135,00
	LB1103K	34,50		LB110001K	42,50		LB110003K	92,00		LB110005K	135,00
	LB11031	34,50		LB110001W	42,50		LB1100031	92,00		LB1100051	135,00

H 500 mm			H 1500 mm			H 2500 mm			H 3500 mm		
COL.	CODE	€	COL.	CODE	€	COL.	CODE	€	COL.	CODE	€
	LB11112	12,00		LB1100022	20,00		LB1100042	47,00		LB1100062	62,50
	LB1111G	38,50		LB110002G	63,50		LB110004G	114,00		LB110006G	156,50
	LB1111E	38,50		LB110002E	63,50		LB110004E	114,00		LB110006E	156,50
	LB1111K	38,50		LB110002K	63,50		LB110004K	114,00		LB110006K	156,50
	LB11111	38,50		LB1100021	63,50		LB1100041	114,00		LB1100061	156,50

**Basamento Palo Still Ø170 mm**



Basamento in nylon-fibra di vetro per palo diametro 60 mm.

**Base Ø170 mm for Still post**  
Base in fibreglass-nylon for post diameter 60 mm.

**Socle Ø170 mm pour poteau Still**  
Socles en fibre de verre - nylon pour poteau diam.60 mm

COL.	CODE	€
	LB11812	22,00
	LB1181G	34,00
	LB1181E	34,00
	LB1181K	34,00
	LB11811	34,00

**Piastra base a scomparsa palo Still**

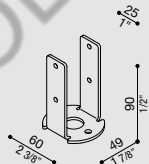

Soluzione alternativa al tradizionale interramento o al basamento palo still mediante staffa di fissaggio a scomparsa. Consiste nell'inserire il palo still sulla staffa preforata da 3mm, realizzata in ferro zincato a caldo per immersione. Accessorio non idoneo per pali still superiori a h. 1500.

**Retractable plate base**  
Alternative solution to the usual burial or to the post base using a retractable fixing bracket. The post is inserted in the 3mm pre-drilled bracket made of hot-dip zinc-coated metal. Accessory not suitable for posts higher than 1500mm.

**Plaque de base rétractable**  
Solution alternative à l'enfouissement traditionnel ou mise en place moyennant un étrier de fixation rétractable du pieu post. Insérer le poteau Still sur l'étrier pré-percé de 3 mm, réalisé en fer galvanisé à chaud par immersion. Accessoire ne convenant pas à des poteaux Still de plus de 1500mm de haut.

COL.	CODE	€
	LB1130006	14,00

**Dima e kit di fissaggio Palo Still**

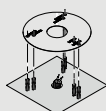

Dima, tirafondi e minuteria per ancoraggio del basamento al terreno.

**Template and fixing kit Still Post diam. 60 mm.**  
Template, fixing bolts and small metal parts to secure the base to the ground.

**Gabarit, tire-fond et visserie pour poteau Still**  
Gabarit, tire-fond et visserie pour l'ancrage du socle au sol.

COL.	CODE	€
	LB11254	13,00

**Braccetto Torch**

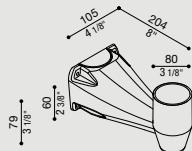

Braccetto in tecnopolimero. Possibilità di montaggio a parete o su palo (doppio o tripla).

**Bracket Torch**  
Technopolymer bracket. Can be fitted to the wall or on a post (double or triple).

**Bras Torch**  
Bras en technopolymère. Utilisation pour poteau (2 ou 3 produits) ou mur.

COL.	CODE	€
	LB11362	10,00

# Excell



indoor





outdoor

Adatto anche ad uso esterno. Base e anello in tecnopolimero. Guarnizione in silicone. Chiusura/apertura diffusore senza utensili.

**ENG** Suitable for indoor and outdoor use. Technopolymer base and ring. Silicone gasket. The diffuser can be opened/closed without the need for tools.

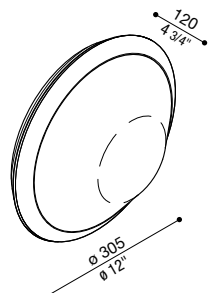
**FRA** Egalement adapté à l'usage à l'extérieur. Base et anneau en technopolymère. Joint en silicone. Fermeture/ouverture du diffuseur sans outils.

<b>Excell tonda 300</b>				<b>DIFF. SEMITRASP.</b>	Fino ad esaurimento. Until our stock lasts. Jusqu'à épuisement de stock.	
<b>IP 54 IK 07 2J xx5 CE UK CA</b>						
LAMP	ATT.	LAMP MAX	CFL	COL.	CODE	€
	E27	1x100	1x20		<b>LB26221</b>	<b>46,00</b>

Diffusore in policarbonato. Riflettore in alluminio tipo L2-1060 o policarbonato.  
Lampade dim. max: E27 152 mm Ø 48 mm.

Polycarbonate diffuser. Reflector made of polycarbonate or aluminium type L2-1060.  
Lamp max. dim: E27 152 mm Ø 48 mm.

Diffuseur en polycarbonate. Réflecteur en polycarbonate ou aluminium type L2-1060.  
Lampes dim. max: E27 152 mm Ø 48 mm.

## Finishing

 Bianco da stampaggio  
White  
Blanc moulé



indoor



outdoor

Adatto anche ad uso esterno. Base e diffusore in polycarbonato. Riflettore in alluminio tipo L2-1060. Guarnizione in silicone. Viti in acciaio inox A4. Predisposizione ingresso tubo rigido 16/20 mm.

**ENG** Suitable for indoor and outdoor use.

Polycarbonate base and diffuser. Reflector made of aluminium type L2-1060.

Silicone gasket. A4 stainless steel screws.

Cable entry option on the side with rigid tube 16/20 mm.

**FRA** Egalement adapté à l'usage à l'extérieur.

Base et diffuseur en polycarbonate. Réflecteur en aluminium type L2-1060.

Joint en silicone. Vis inox type A4.

Possibilité d'entrée avec un tube rigide 16/20 mm.

**Luce tonda 260**



**Luce mini tonda 220**



**Luce ovale 260**



**Luce mini ovale 220**



# Luce

## Luce tonda 260

DIFF.  
SEMITRASP.

IP66 IK 10 20J xx9 CE UK  
CR

LAMP	ATT.	LAMP MAX	CFL	COL.	CODE	€
	E27	1x100	1x23		LB53221	49,00
					LB53224	49,00

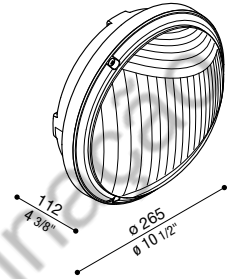

Lampade dim. max: E27 152 mm Ø 48 mm

Lamp max. dim: E27 152 mm Ø 48 mm

Lampes dim. max: E27 152 mm Ø 48 mm

## Luce mini tonda 220

DIFF.  
SEMITRASP.

IP66 IK 09 10J xx7 CE UK  
CR

LAMP	ATT.	LAMP MAX	CFL	COL.	CODE	€
	E27	1x60	1x15		LB53121	30,00
					LB53124	30,00

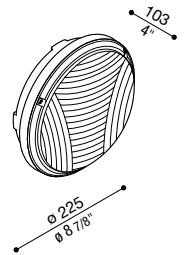

Lampade dim. max: E27 128 mm Ø 48 mm

Lamp max. dim: E27 128 mm Ø 48 mm

Lampes dim. max: E27 128 mm Ø 48 mm

SAPOL - Material Elétrico e Iluminação



**Luce ovale 260**

DIFF. SEMITRASP.

IP 65 IK 10 20J xx9 CE UK CR

LAMP	ATT.	LAMP MAX	CFL	COL.	CODE	€
	E27	1x75	1x20	<input type="checkbox"/>	LB53421	39,50
				<input type="checkbox"/>	LB53424	39,50

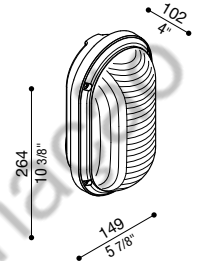

Lampade dim. max: E27 152 mm Ø 48 mm

Lamp max. dim: E27 152 mm Ø 48 mm

Lampes dim. max: E27 152 mm Ø 48 mm

**Luce mini ovale 220**

DIFF. SEMITRASP.

IP 66 IK 09 10J xx7 CE UK CR

LAMP	ATT.	LAMP MAX	CFL	COL.	CODE	€
	E27	1x60	1x15	<input type="checkbox"/>	LB53621	26,00
				<input type="checkbox"/>	LB53624	26,00

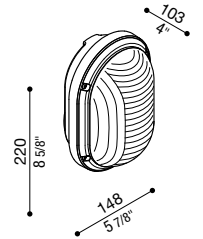

Lampade dim. max: E27 128 mm Ø 48 mm

Lamp max. dim: E27 128 mm Ø 48 mm

Lampes dim. max: E27 128 mm Ø 48 mm

**Finishing**

- Bianco da stampaggio  
White  
Blanc moulé
- Grigio Ral 7035 da stampaggio  
Grey Ral 7035  
Gris Ral 7035 moulé



# Nido



indoor



outdoor

Adatto anche ad uso esterno. Base e diffusore in polycarbonato.  
Riflettore in alluminio tipo L2-1060.  
Guarnizione in silicone. Viti in acciaio inox A4.  
Modello brevettato.

**ENG** Suitable for indoor and outdoor use. Polycarbonate base and diffuser.  
Reflector made of aluminium type L2-1060. Silicone gasket. A4 stainless steel  
screws. Patented model.

**FRA** Egalement adapté à l'usage à l'extérieur. Base et diffuseur en polycarbonate.  
Réflecteur en aluminium type L2-1060. Joint en silicone. Vis inox type A4.  
Modèle breveté.



**Nido tonda 240**



**Nido ovale 240**



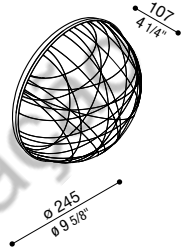



<b>Nido tonda 240</b>				<b>DIFF. OPAL.</b>	<b>DIFF. SEMITRASP.</b>	Fino ad esaurimento. Until our stock lasts. Jusqu'à épuisement de stock.	
<b>IP 55 IK 08 5J xx7 CE UK CRA</b>							
LAMP	ATT.	LAMP MAX	CFL	COL.	CODE	CODE	€
	E27	1x20			<b>LB24220</b>	<b>LB2422N</b>	<b>27,00</b>

LB2422A diffusore ambra verniciato traslucido. Lampade dim. max: E27 145 mm Ø 48 mm

LB2422A translucent amber diffuser (painted). Lamp max. dim: E27 145 mm Ø 48 mm

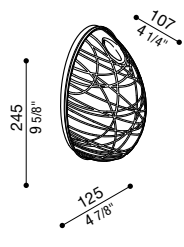
LB2422A Diffuseur verni couleur ambre translucide. Lampes dim. max: E27 145 mm Ø 48 mm

<b>Nido ovale 240</b>				<b>DIFF. OPAL.</b>	<b>DIFF. SEMITRASP.</b>	Fino ad esaurimento. Until our stock lasts. Jusqu'à épuisement de stock.	
<b>IP 55 IK 08 5J xx7 CE UK CRA</b>							
LAMP	ATT.	LAMP MAX	CFL	COL.	CODE	CODE	€
	E27	1x20			<b>LB24120</b>	<b>LB2412N</b>	<b>20,00</b>

LB2412A diffusore ambra verniciato traslucido. Lampade dim. max: E27 145 mm Ø 48 mm

LB2412A translucent amber diffuser (painted). Lamp max. dim: E27 145 mm Ø 48 mm

LB2412A Diffuseur verni couleur ambre translucide. Lampes dim. max: E27 145 mm Ø 48 mm

**Finishing**

 Trasparente Satinato  
Transparent satin effect  
Transparent satiné

**ACCESSORI**

Accessories / Accessoires

**Sensore di Movimento**

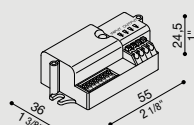

Kit di montaggio per sensore di movimento crepuscolare.  
Per la versione E27 è consigliabile l'utilizzo di lampadine FTB ad accensione illimitata (ON/OFF unlimited).

**Motion sensor**  
Mounting kit for motion sensor (which may be mounted inside the fixture).  
For E27 version we recommend the use of "on/off unlimited" FTP lamps.

**Détecteur de présence**  
Kit de montage pour détecteur de mouvement crépusculaire.  
Pour la version E27 il est conseillé d'utiliser l'appareil avec des lampes FTB de type on/off illimité (ON/OFF unlimited).

COL.	CODE	€
	<b>LB11295</b>	<b>48,00</b>

**Morsettiere**  
Terminal blocks



**Scaricatori SPD**  
Surge protector devices



# Tartaruga



Adatto anche ad uso esterno. Diffusore in vetro trasparente. Riflettore in alluminio tipo L2-1060. Viti in acciaio inox A4.

**ENG** Suitable for indoor and outdoor use. Transparent glass diffuser. Reflector made of aluminium type L2-1060. A4 Stainless steel screws.

**FRA** Egalement adapté à l'usage à l'extérieur. Diffuseur en verre transparent. Réflecteur en aluminium type L2-1060. Vis inox type A4.

**Tartaruga tonda 200  
con gabbia**



**Tartaruga tonda 200  
senza gabbia**



**Tartaruga ovale 200  
con gabbia**



**Tartaruga ovale 200  
senza gabbia**



**Tartaruga ovale  
3 entrate 195 mm**



**Tartaruga ovale  
3 entrate 170 mm**





**Tartaruga tonda  
200 con gabbia**

DIFF.  
VETRO

IP 44 IK 06 1J xx3 CE UK  
CA

LAMP	ATT.	LAMP MAX	CFL	COL.	CODE	€
	E27	1x75	1x11	<input type="checkbox"/>	LB46121	17,50

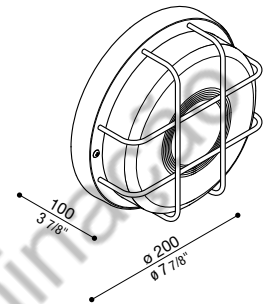

Base e gabbia in tecnopolimero.  
Lampade dim. max: E27 120 mm Ø 45 mm

Technopolymer base and cage.  
Lamp max. dim: E27 120 mm Ø 45 mm

Base et grille en technopolymère.  
Lampes dim. max: E27 120 mm Ø 45 mm

**Tartaruga tonda  
200 senza  
gabbia**

DIFF.  
VETRO

IP 44 IK 06 1J xx3 CE UK  
CA

LAMP	ATT.	LAMP MAX	CFL	COL.	CODE	€
	E27	1x75	1x11	<input type="checkbox"/>	LB46521	16,00

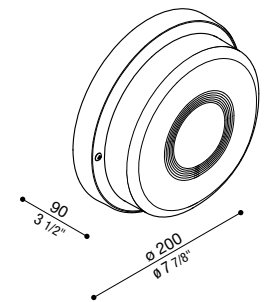

Base in tecnopolimero.  
Lampade dim. max: E27 120 mm Ø 45 mm

Technopolymer base.  
Lamp max. dim: E27 120 mm Ø 45 mm

Base en technopolymère.  
Lampes dim. max: E27 120 mm Ø 45 mm

**Tartaruga ovale  
200 con gabbia**

DIFF.  
VETRO

IP 44 IK 06 1J xx3 CE UK  
CA

LAMP	ATT.	LAMP MAX	CFL	COL.	CODE	€
	E27	1x60	1x11	<input type="checkbox"/>	LB44121	11,00
				<input checked="" type="checkbox"/>	LB44122	11,00
				<input type="checkbox"/>	LB44124	11,00

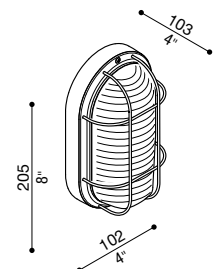

Base e gabbia in tecnopolimero.  
Lampade dim. max: E27 120 mm Ø 45 mm

Technopolymer base and cage.  
Lamp max. dim: E27 120 mm Ø 45 mm

Base et grille en technopolymère.  
Lampes dim. max: E27 120 mm Ø 45 mm

**Finishing**

<input type="checkbox"/>	Bianco da stampaggio White Blanc moulé	<input type="checkbox"/>	Grigio Ral 7035 da stampaggio Grey Ral 7035 Gris Ral 7035 moulé
<input checked="" type="checkbox"/>	Nero da stampaggio Black Noir moulé		

# Tartaruga

## Tartaruga ovale 200 senza gabbia

DIFF.  
VETRO

IP 44 IK 06 1J xx3 CE UK  
CR

LAMP	ATT.	LAMP MAX	CFL	COL.	CODE	€
	E27	1x60	1x11		LB44521	10,00

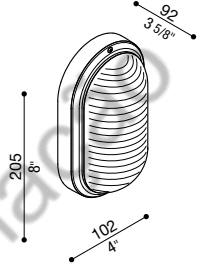

Base in tecnopolimero. Lampade dim. max: E27 120 mm Ø 45 mm

Technopolymer base.  
Lamp max. dim: E27 120 mm Ø 45 mm

Base en technopolymère.  
Lampes dim. max: E27 120 mm Ø 45 mm

## Tartaruga ovale 3 entrate 170 mm

DIFF.  
VETRO

IP 44 IK 06 1J xx3 CE UK  
CR

LAMP	ATT.	LAMP MAX	CFL	COL.	CODE	€
	E27	1x60			LB41224	11,50

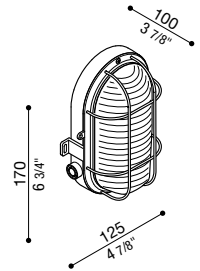

Base in poliammide. Gabbia in metallo zincato. Predisposizione triplo ingresso tubo 16/20 mm. Lampade dim. max: E27 120 mm Ø 45 mm

Polyamide base. Zinc-coated metal cage.  
Three cable entry options on the side with rigid tube 16/20 mm.  
Lamp max. dim: E27 120 mm Ø 45 mm

Base en polyamide. Grille en tôle zinguée.  
Possibilité pour trois entrées avec tube rigide 16/20 mm.  
Lampes dim. max: E27 120 mm Ø 45 mm

## Tartaruga ovale 3 entrate 195 mm

DIFF.  
VETRO

IP 44 IK 06 1J xx3 CE UK  
CR

LAMP	ATT.	LAMP MAX	CFL	COL.	CODE	€
	E27	1X100	1X11		LB41424	16,00

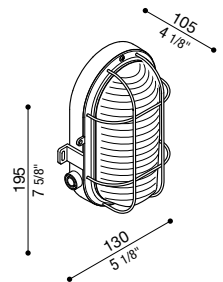

Base in poliammide. Gabbia in metallo zincato. Predisposizione triplo ingresso tubo 16/20 mm. Lampade dim. max: E27 120 mm Ø 45 mm

Polyamide base. Zinc-coated metal cage.  
Three cable entry options on the side with rigid tube 16/20 mm.  
Lamp max. dim: E27 120 mm Ø 45 mm

Base en polyamide. Grille en tôle zinguée.  
Possibilité pour trois entrées avec tube rigide 16/20 mm.  
Lampes dim. max: E27 120 mm Ø 45 mm

### Finishing

	Bianco da stampaggio White Blanc moulé		Grigio Ral 7035 da stampaggio Grey Ral 7035 Gris Ral 7035 moulé
	Nero da stampaggio Black Noir moulé		





**Modelli idonei per sensori** *Motion sensor list - Modèles pour détecteur*

	<b>KOBO</b>	Predisposto per rilevatore <i>Suitable for motion sensor</i> <i>Conforme pour détecteur de présence</i>	p. 66		<b>LINE</b>		p. 128
	<b>ROSS</b>	 INCLUDED →	p. 42		<b>NOVA / CLASS</b>	 INCLUDED	p. 428
	<b>ART</b>	 INCLUDED	p. 32				

Rilevatore di presenza incluso  
*Motion sensor included*  
*Détecteur inclus*

→ Funzione corridoio  
*Corridor function*  
*Fonction corridor*

Sensore crepuscolare  
*Day night sensor*  
*Détecteur crépusculaire*

SAPOL - Material Elétrico e Iluminação

# Sensori

## Sensore di movimento Motion sensor - Détecteur de présence

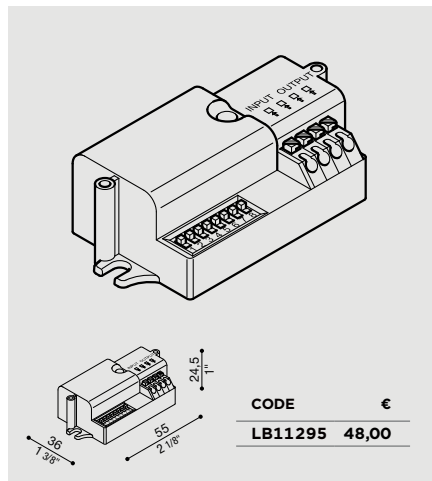

### Distribuzioni fotometriche Photometric distribution Distributions photométriques

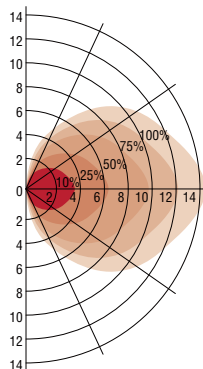

Montaggio a parete (m)  
Altezza di installazione  
suggerita: 1+1,8 m.

Wall mounting (m)  
Recommended  
installation height: 1:1.8 m.

Montage mural (m)  
Hauteur d'installation  
recommandée : 1 à 1,8 m.

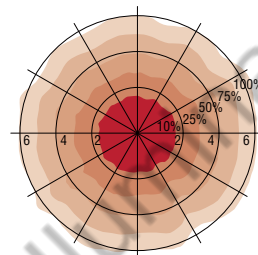

Montaggio a soffitto (m)  
Altezza di installazione  
suggerita: 2,5+6 m.

Ceiling mounting (m)  
Recommended  
installation height: 2.5:6 m.

Montage au plafond (m)  
Hauteur d'installation  
recommandée : 2,5 à 6 m.

### ITA CARATTERISTICHE TECNICHE

Voltaggio:	220/240VAC 50Hz
Sistema HF:	5.8GHz ± 75MHz, Banda d'onda ISM
Potenza di trasmissione:	<0,5mW
Alimentazione:	800W (carica resistente) 400W (carico capacitivo)
Angolo di rilevamento:	150° (installazione a muro) 360° (installazione a soffitto)
Consumo:	<0,5W (stanby)
Zona di rilevamento:	Max (P x A): 12m x 6m
Altezza di montaggio:	Max. 6m
Rilevatore di movimento:	0.5 ~ 3 m/s
Temperatura di lavoro:	-35°C ~ +70°C

Il sensore rileva i movimenti delle persone. Se un movimento è rilevato nel suo campo di rilevamento, la luce si accende per il tempo impostato. Tutti i movimenti che intervengono durante la durata definita attivano il sensore.

**ATTENZIONE:** il rilevamento è possibile attraverso le porte, muri e pareti di sottili lastre di vetro.

**Le persone o gli oggetti che si muovono verso il sensore sono meglio rilevati. La distanza tra due rilevatori deve sempre essere superiore al raggio del campo di rilevamento.**

Il cablaggio è polarizzato è quindi necessario rispettare le polarità Fase e Neutro.

**NOTA:** in caso di utilizzo con delle sorgenti luminose fluorescenti compatte E27 è necessario assicurarsi che queste siano di tipo ON/OFF UNLIMITED (ACCENSIONI ILLIMITATE); inoltre è consigliabile impostare una temporizzazione che assicuri un'illuminazione di 5 min minimo al fine di evitare un'usura prematura.

LOMBARDO S.r.l. non risponde di danni a cose e persone imputabili a modifiche, manomissioni o impiego non conforme alle caratteristiche tecniche del prodotto.

### ENG TECHNICAL CHARACTERISTICS

Voltage:	220/240VAC 50Hz
HF System:	5.8GHz ± 75MHz, ISM wave band
Transmission power:	<0,5mW
Input:	800W (resistive charging) 400W (inductive charging)
Detection angle:	150° (wall installation) 360° (ceiling installation)
Power consumption:	<0,5W (stanby)
Detection zone:	Max (D x H): 12m x 6m
Mounting height:	6m Max.
Motion detection:	0.5 ~ 3 m/s
Operating temperature:	-35°C ~ +70°C

The sensor detects the movements of persons. If a movement is detected within its detection area, the light will start for the defined time. All movements during the defined time activate the sensor.

**CAUTION:** detection is possible through doors, walls and thin glass panes.

**Persons and objects moving towards the sensor are better detected. The distance between two detectors has to be always higher than the radius of the detection area.**

The wiring is polarized and therefore it is necessary to respect the polarities Phase and Neutral.

**NOTE:** In case of use of compact E27 fluorescent lamps, it is necessary to assure that they are of UNLIMITED ON/OFF type; furthermore, it is recommended to install a timer assuring minimum 5 min. lighting in order to avoid early wear.

LOMBARDO S.r.l. is not liable for damage to property and people due to modification, tampering and use not in conformity with the technical characteristics of the product.

### FRA CARACTERISTIQUES TECHNIQUES

Voltaggio:	220/240VAC 50Hz
Système HF:	5.8GHz ± 75MHz, bande des ondes ISM
Puissance de transmission:	<0,5mW
Alimentation:	800W (charge résistive) 400W (charge capacitive)
Angle de detection:	150° (installation murale) 360° (installation au plafond)
Puissance consommée:	<0,5W (stanby)
Zone de détection:	Max. (P x H) : 12 m x 6 m
Hauteur de montage:	6 m Max.
Détection de mouvement:	0,5 ~ 3 m/s
Température de travail:	-35°C ~ +70°C

Le sensore détecte les mouvements des personnes. Si un mouvement est détecté dans son champ de détection, la lumière s'allumera pour la durée définie. Tous les mouvements qui interviennent pendant la durée définie vont activer le sensor.

**ATTENTION:** la détection est possible à travers les portes, les murs et les parois de plaques de verre fines.

**Les personnes et les objets en mouvement vers le sensor sont mieux détectés. La distance entre deux détecteurs doit être toujours supérieure au rayon du champ de détection.**

Le câblage est polarisé donc il est nécessaire de respecter les polarités Phase et Neutre.

**NOTE:** En cas d'utilisation avec des sources fluo-compacte E27, il est nécessaire de s'assurer que celles-ci soient de type ON/OFF UNLIMITED (on/off illimité); il faut en outre mettre une temporisation assurant un éclairage de 5min minimum afin d'éviter une usure prématurée.

LOMBARDO S.r.l. n'est pas responsable des dommages aux biens et aux personnes en raison de modifications, manipulations ou utilisation non conforme aux caractéristiques techniques du produit.



**Sensore crepuscolare** Day and night sensor - Détecteur crépusculaire

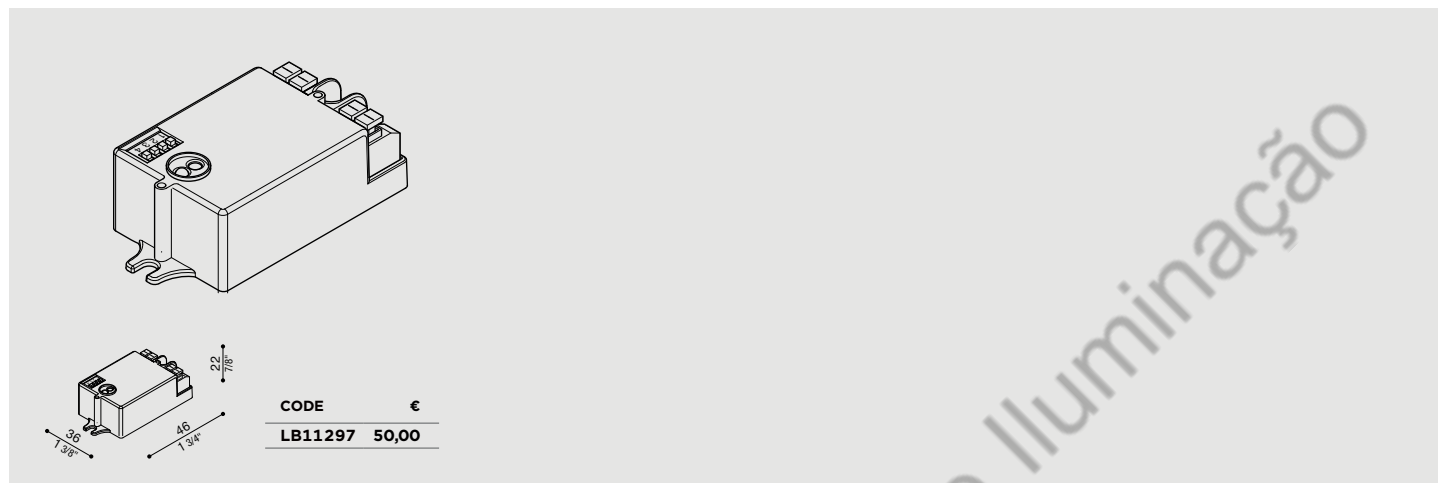

**ITA CARATTERISTICHE TECNICHE**

Voltaggio: 220/240VAC 50Hz  
 Potenza: 400W  
 Temperatura di lavoro: -20°C ~ +50°C

LOMBARDO S.r.l. non risponde di danni a cose e persone imputabili a modifiche, manomissioni o impiego non conforme alle caratteristiche tecniche del prodotto.

- Accende automaticamente le luci al crepuscolo e si spegne all'alba.
- Risparmia energia riducendo il tempo di funzionamento della lampada.
- Distingue esattamente la luce del sole e la luce led.
- Accensione/spengimento regolabili.
- Le dimensioni compatte lo rendono adatto per installazioni in piccoli spazi.

**ENG TECHNICAL CHARACTERISTICS**

Voltage: 220/240VAC 50Hz  
 Power: 400W  
 Operating temperature: -20°C ~ +50°C

LOMBARDO S.r.l. is not liable for damage to property and people due to modification, tampering and use not in conformity with the technical characteristics of the product.

- Automatically turn on lights at dusk and off at dawn.
- Save energy by reducing light fixture operating time.
- Exactly distinguish sunlight and LED light and can be built-in LED lighting fixtures.
- Super compact size make it is suitable to be fixed in small fittings.
- Adjustable switching On/Off ambient light level.

**FRA CARACTERISTIQUES TECHNIQUES**

Voltage: 220/240VAC 50Hz  
 Puissance: 400W  
 Température de travail: -20°C ~ +50°C

LOMBARDO S.r.l. n'est pas responsable des dommages aux biens et aux personnes en raison de modifications, manipulations ou utilisation non conforme aux caractéristiques techniques du produit.

- Il allume automatiquement les lumières au crépuscule et les éteint à l'aube.
- Permet d'économiser de l'énergie en réduisant la durée du fonctionnement de la lampe.
- Distingue exactement la lumière du soleil et la lumière des LED.
- Ses dimensions très compactes permettent de l'installer même dans des petits appareils.
- Mise en marche/arrêt réglable

# Morsettiere e SPD

## Morsettiere Terminal blocks - Borniers

### Morsettiera coassiale



Morsettiera coassiale a 3 poli, IP68, per cavo  $\varnothing$  7/12 mm.

**Coaxial Terminal block**  
Coaxial 3-pole terminal block,  
IP68, for cable diameter 7/12 mm.

**Bornier coaxial**  
Bornier coaxial à 3 pôles, IP68,  
pour câble diam. 7/12 mm

CODE	€
<b>LB11293</b>	<b>16,00</b>

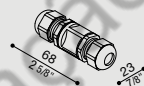

### Morsettiera lineare a 3 vie



Morsettiera lineare a 3 vie a 3 poli, IP68, per cavo  $\varnothing$  7/13,5 mm.

**3 way linear terminal block**  
3-way 3-pole linear terminal block,  
IP68, for cable  $\varnothing$  7/13.5 mm.

**Bornier linéaire 3 voies**  
Bornier linéaire 3 voies à 3 pôles,  
IP68, pour câble diam. 7/13,5 mm

CODE	€
<b>LB11294</b>	<b>25,50</b>

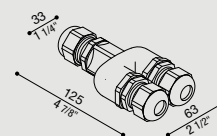

## Scaricatori di sovratensione Surge protector devices - Dispositif anti surtension

### Scaricatore di sovratensione SPD



Scaricatore di sovratensione di tipo II e tipo III.  
Tensione di funzionamento 120/320 VAC 50/60Hz.  
Tensione massima di scarica 10kV e corrente di scarica massima 10kAmp. grado di protezione IP67.  
Idoneo per installazioni a monte dell'apparecchio ed in serie rispetto al corpo illuminante.  
Tempi medi di intervento 8/20 $\mu$ s  
Dotato di indicatore Led di funzionamento, a led spento il dispositivo deve essere sostituito.

**Surge protector device type I and type III.**  
Operating voltage 120/320 VAC 50/60Hz. Maximum voltage surge 10kV and maximum discharge current 10kAmp, protection grade IP67. Suitable for installation in series connection and before the lighting luminaire. Response time 8/20 $\mu$ s. Equipped with power indicator led, if the led is off the device must be replaced.

**Dispositif anti surtension type II et III.**  
Tension d'opération 120/320 VAC 50/60Hz. Tension de décharge maximal de 10kV et courant de décharge maximal de 10kAmp. Degré de protection IP67. Approprié pour installations en amont de l'alimentation et en série du dispositif d'éclairage. Temps de réponse: 8/20 $\mu$ s. Équipé d'un indicateur de fonctionnement Led. Avec la Led éteinte, l'appareil doit être remplacé.

CODE	€
<b>LB11298</b>	<b>25,00</b>

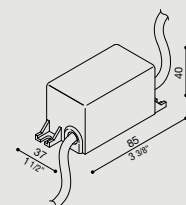

### Scaricatore di sovratensione SPD



Scaricatore di sovratensione di tipo II.  
Tensione di funzionamento 240 VAC 50/60Hz.  
Tensione massima di scarica 10kV e corrente di scarica massima 20kAmp. grado di protezione IP67.  
Idoneo per installazioni a monte dell'apparecchio ed in parallelo rispetto al corpo illuminante.  
Tempi medi di intervento <25ns.  
Dotato di indicatore Led di funzionamento, a led spento il dispositivo deve essere sostituito  
Il componente non è idoneo ad installazione su impianti privi di messa a terra.

**Surge protector device type II.**  
Operating voltage 240 VAC 50/60Hz. Maximum voltage surge 10kV and maximum discharge current 20kAmp, protection grade IP67. Suitable for installation in parallel connection and before the lighting luminaire. Response time <25ns. Equipped with power indicator led, if the led is off the device must be replaced. The device is not suitable for installation without ground.

**Dispositif anti surtension type II.**  
Dispositif anti surtension type II. Tension d'opération 240 VAC 50/60Hz. Tension de décharge maximal de 10kV et courant de décharge maximal de 20kAmp. Degré de protection IP67. Approprié pour installations en amont de l'alimentation et en parallèle du dispositif d'éclairage. Temps de réponse: <25ns. Équipé d'un indicateur de fonctionnement Led. Avec la led éteinte, l'appareil doit être remplacé. Non adapté à installation sans mise à la terre.

CODE	€
<b>LB11299</b>	<b>30,00</b>

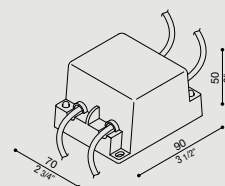















PROGETTO LUCE





LOMBARDO



50°  
1969-2019

# RICERCA ALFANUMERICA PER CODICE

Codice Code Réf.	Pag. Page	Codice Code Réf.	Pag. Page	Codice Code Réf.	Pag. Page	Codice Code Réf.	Pag. Page	Codice Code Réf.	Pag. Page
BL1161012	37	LB1070072	314	LB11190	405	LB1150026	151	LB1260019	194
BL1161013	37	LB1070073	309	LB11191	405	LB1150035	179	LB1262004	207
BL116101N	37	LB1070074	314	LB11231	132	LB1150036	150	LB1262005	207
BL1161022	37	LB1080001	355	LB1123E	132	LB1150037	150	LB12622	434
BL1161023	37	LB1080002	355	LB1123G	132	LB1150038	150	LB1280003	102
BL116102N	37	LB1080003	355	LB1123K	132	LB1150039	150	LB1280004	102
BL1161032	37	LB1080004	355	LB11254	435	LB11530	419	LB1290001	364
BL1161033	37	LB1090000	417	LB11255	413	LB11540	419	LB1290002	364
BL116103N	37	LB1090002	417	LB11293	448	LB11550	419	LB1290003	364
BL1161042	37	LB1100000	392	LB11294	448	LB11560	419	LB1290004	364
BL1161043	37	LB1100001	392	LB11295	446	LB11571	398	LB1290005	364
BL116104N	37	LB1100002	392	LB11297	447	LB11572	398	LB1290006	364
BL1161052	37	LB1100003	392	LB11298	448	LB11573	398	LB1300001	71
BL1161053	37	LB1100004	392	LB11299	448	LB11576	132	LB1300002	71
BL116105N	37	LB1100005	392	LB1130001	132	LB11581	405	LB1300003	71
LB1070001	234	LB1100012	144	LB1130002	132	LB11582	405	LB1300004	71
LB1070002	234	LB110001E	144	LB1130003	132	LB11583	405	LB1300005	71
LB1070004	261	LB110001G	144	LB1130004	132	LB11584	405	LB1310001	254
LB1070005	261	LB110001K	144	LB1130006	435	LB11611	393	LB1330001	179
LB1070006	261	LB110001W	144	LB1130007	133	LB1161G	393	LB1330011	179
LB1070007	261	LB1100021	144	LB1130008	133	LB11621	393	LB133001E	179
LB1070008	235	LB1100022	144	LB1130009	133	LB1162G	393	LB133001G	179
LB1070009	287	LB110002E	144	LB1130010	133	LB11652	392	LB133001K	179
LB1070011	287	LB110002G	144	LB1130011	133	LB1165G	392	LB133001V	179
LB1070012	287	LB110002K	144	LB1130012	133	LB1165K	392	LB1350001	84
LB1070013	235	LB1100031	144	LB1130013	133	LB11660	392	LB1350002	84
LB1070014	235	LB1100032	144	LB1130014	133	LB11670	392	LB1350003	84
LB1070015	235	LB110003E	144	LB11312	425	LB11680	392	LB1350004	84
LB1070016	235	LB110003G	144	LB1131G	425	LB11690	375	LB1350005	84
LB1070018	287	LB110003K	144	LB1131K	425	LB11693	381	LB1350006	84
LB1070019	287	LB1100041	144	LB11362	435	LB11811	435	LB1350007	84
LB1070020	235	LB1100042	144	LB11432	426	LB11812	435	LB1350008	84
LB1070021	235	LB110004E	144	LB1143G	426	LB1181E	435	LB1360001	261
LB1070025	254	LB110004G	144	LB1143K	426	LB1181G	435	LB1380000	268
LB1070026	254	LB110004K	144	LB11442	426	LB1181K	435	LB1380001	267
LB1070027	254	LB1100051	144	LB1144G	426	LB11841	392	LB1380002	267
LB1070028	254	LB1100052	144	LB1144K	426	LB1184G	392	LB1380003	267
LB1070029	275	LB110005E	144	LB1150003	150	LB11854	415	LB1380004	267
LB1070030	275	LB110005G	144	LB1150004	150	LB1190001	234	LB1380005	267
LB1070031	275	LB110005K	144	LB1150005	150	LB12114	415	LB1380006	267
LB1070032	275	LB1100061	144	LB1150006	150	LB12134	415	LB1380007	268
LB1070039	234	LB1100062	144	LB1150007	151	LB1230001	250	LB1380008	268
LB1070041	250	LB110006E	144	LB1150008	151	LB1250001	381	LB1380009	267
LB1070043	303	LB110006G	144	LB1150009	151	LB1260001	194	LB1380010	268
LB1070054	250	LB110006K	144	LB1150010	151	LB1260002	194	LB1390001	275
LB1070055	250	LB1100081	145	LB1150011	150	LB1260003	194	LB1390002	275
LB1070056	250	LB1100082	145	LB1150012	150	LB1260004	194	LB1390003	275
LB1070057	250	LB110008E	145	LB1150013	150	LB1260005	194	LB1390004	275
LB1070059	254	LB110008G	145	LB1150014	150	LB1260006	194	LB140000E	118
LB1070060	254	LB110008K	145	LB1150015	151	LB1260007	194	LB140000G	118
LB1070061	254	LB11031	144	LB1150016	151	LB1260008	194	LB140000K	118
LB1070063	261	LB11033	144	LB1150017	151	LB1260009	194	LB140000W	118
LB1070064	309	LB1103E	144	LB1150018	151	LB1260010	194	LB140001E	118
LB1070065	275	LB1103G	144	LB1150019	151	LB1260011	194	LB140001G	118
LB1070066	309	LB1103K	144	LB1150020	151	LB1260012	194	LB140001K	118
LB1070067	330	LB11111	144	LB1150021	151	LB1260013	194	LB140001W	118
LB1070068	330	LB11112	144	LB1150022	151	LB1260014	194	LB140002E	118
LB1070069	330	LB1111E	144	LB1150023	151	LB1260015	194	LB140002G	118
LB1070070	330	LB1111G	144	LB1150024	151	LB1260016	194	LB140002K	118
LB1070071	314	LB1111K	144	LB1150025	151	LB1260018	194	LB140002W	118





Codice Code Réf.	Pag. Page	Codice Code Réf.	Pag. Page	Codice Code Réf.	Pag. Page	Codice Code Réf.	Pag. Page	Codice Code Réf.	Pag. Page
LB1400K1E	118	LB59121	432	LD134000N	54	LD134020N	56	LE134020N	56
LB1400K1G	118	LB59122	432	LD1340012	54	LD1340212	56	LE1340212	56
LB1400K1K	118	LB5912G	432	LD1340013	54	LD1340213	56	LE1340213	56
LB1400K1W	118	LB59221	432	LD134001N	54	LD134021N	56	LE134021N	56
LB1400K2E	118	LB59222	432	LD1340022	54	LD1340222	56	LE1340222	56
LB1400K2G	118	LB5922G	432	LD1340023	54	LD1340223	56	LE1340223	56
LB1400K2K	118	LB78122	419	LD134002N	54	LD134022N	56	LE134022N	56
LB1400K2W	118	LB7812G	419	LD1340032	54	LD1340232	56	LE1340232	56
LB1460001	287	LB7812K	419	LD1340033	54	LD1340233	56	LE1340233	56
LB1460002	287	LB7852N	407	LD134003N	54	LD134023N	56	LE134023N	56
LB1470001	314	LB79122	419	LD1340042	55	LE1340042	55	LL104B3	402
LB2412N	441	LB7912G	419	LD1340043	55	LE1340043	55	LL104BN	402
LB2412O	441	LB7912K	419	LD134004N	55	LE134004N	55	LL105AL3	402
LB2422N	441	LB80221	430	LD1340052	55	LE1340052	55	LL105ALN	402
LB2422O	441	LB80222	430	LD1340053	55	LE1340053	55	LL105AM3	402
LB26221	436	LB8022G	430	LD134005N	55	LE134005N	55	LL105AMN	402
LB41224	444	LB81221	430	LD1340062	55	LE1340062	55	LL105AS3	402
LB41424	444	LB81222	430	LD1340063	55	LE1340063	55	LL105ASN	402
LB44121	443	LB8122G	430	LD134006N	55	LE134006N	55	LL105B3	402
LB44122	443	LB812M1	430	LD1340072	55	LE1340072	55	LL105BN	402
LB44124	443	LB812M2	430	LD1340073	55	LE1340073	55	LL107000D2	228
LB44521	444	LB812MG	430	LD134007N	55	LE134007N	55	LL107000D3	228
LB46121	443	LB82121	423	LD1340082	55	LE1340082	55	LL107000DB	228
LB46521	443	LB82122	423	LD1340083	55	LE1340083	55	LL107000DN	228
LB49121	352	LB8212G	423	LD134008N	55	LE134008N	55	LL107000L2	228
LB4912E	352	LB82221	422	LD1340092	55	LE1340092	55	LL107000L3	228
LB4912G	352	LB82222	422	LD1340093	55	LE1340093	55	LL107000LB	228
LB4912K	352	LB8222G	422	LD134009N	55	LE134009N	55	LL107000LN	228
LB49221	352	LB82321	424	LD1340102	55	LE1340102	55	LL107000M2	228
LB4922E	352	LB82322	424	LD1340103	55	LE1340103	55	LL107000M3	228
LB4922G	352	LB8232G	424	LD134010N	55	LE134010N	55	LL107000MB	228
LB4922K	352	LB82721	422	LD1340112	55	LE1340112	55	LL107000MN	228
LB49421	352	LB82722	422	LD1340113	55	LE1340113	55	LL107000S2	228
LB4942E	352	LB8272G	422	LD134011N	55	LE134011N	55	LL107000S3	228
LB4942G	352	LB84121	423	LD1340122	54	LE1340122	54	LL107000SB	228
LB4942K	352	LB84122	423	LD1340123	54	LE1340123	54	LL107000SN	228
LB49521	352	LB8412G	423	LD134012N	54	LE134012N	54	LL107001D2	229
LB4952E	352	LB84221	423	LD1340132	54	LE1340132	54	LL107001D3	229
LB4952G	352	LB84222	423	LD1340133	54	LE1340133	54	LL107001DB	229
LB4952K	352	LB8422G	423	LD134013N	54	LE134013N	54	LL107001DN	229
LB53121	438	LB84321	424	LD1340142	54	LE1340142	54	LL107001L2	229
LB53124	438	LB84322	424	LD1340143	54	LE1340143	54	LL107001L3	229
LB53221	438	LB8432G	424	LD134014N	54	LE134014N	54	LL107001LB	229
LB53224	438	LB84421	424	LD1340152	54	LE1340152	54	LL107001LN	229
LB53421	439	LB84422	424	LD1340153	54	LE1340153	54	LL107001M2	229
LB53424	439	LB8442G	424	LD134015N	54	LE134015N	54	LL107001M3	229
LB53621	439	LB85121	422	LD1340162	56	LE1340162	56	LL107001MB	229
LB53624	439	LB85122	422	LD1340163	56	LE1340163	56	LL107001MN	229
LB58121	431	LB8512G	422	LD134016N	56	LE134016N	56	LL107001S2	229
LB58122	431	LB85221	422	LD1340172	56	LE1340172	56	LL107001S3	229
LB5812G	431	LB85222	422	LD1340173	56	LE1340173	56	LL107001SB	229
LB581M1	431	LB8522G	422	LD134017N	56	LE134017N	56	LL107001SN	229
LB581M2	431	LB85321	423	LD1340182	56	LE1340182	56	LL1070022	230
LB581MG	431	LB85322	423	LD1340183	56	LE1340183	56	LL1070023	230
LB58221	431	LB8532G	423	LD134018N	56	LE134018N	56	LL107002B	230
LB58222	431	LB85421	423	LD1340192	56	LE1340192	56	LL107002N	230
LB5822G	431	LB85422	423	LD1340193	56	LE1340193	56	LL1070032	230
LB582M1	431	LB8542G	423	LD134019N	56	LE134019N	56	LL1070033	230
LB582M2	431	LD1340002	54	LD1340202	56	LE1340202	56	LL107003B	230
LB582MG	431	LD1340003	54	LD1340203	56	LE1340203	56	LL107003N	230

# RICERCA ALFANUMERICA PER CODICE

Codice Code Réf.	Pag. Page	Codice Code Réf.	Pag. Page	Codice Code Réf.	Pag. Page	Codice Code Réf.	Pag. Page	Codice Code Réf.	Pag. Page
LL1070042	230	LL1070102	230	LL107017L3	232	LL107032L2	228	LL107036D2	231
LL1070043	230	LL1070103	230	LL107017LN	232	LL107032L3	228	LL107036D3	231
LL107004B	230	LL107010B	230	LL107017M2	232	LL107032LB	228	LL107036DB	231
LL107004N	230	LL107010N	230	LL107017M3	232	LL107032LN	228	LL107036DN	231
LL107005D2	231	LL107011D2	231	LL107017MN	232	LL107032M2	228	LL107036L2	231
LL107005D3	231	LL107011D3	231	LL107017S2	232	LL107032M3	228	LL107036L3	231
LL107005DB	231	LL107011DB	231	LL107017S3	232	LL107032MB	228	LL107036LB	231
LL107005DN	231	LL107011DN	231	LL107017SN	232	LL107032MN	228	LL107036LN	231
LL107005L2	231	LL107011L2	231	LL1070182	232	LL107032S2	228	LL107036M2	231
LL107005L3	231	LL107011L3	231	LL1070183	232	LL107032S3	228	LL107036M3	231
LL107005LB	231	LL107011LB	231	LL107018N	232	LL107032SB	228	LL107036MB	231
LL107005LN	231	LL107011LN	231	LL1070192	232	LL107032SN	228	LL107036MN	231
LL107005M2	231	LL107011M2	231	LL1070193	232	LL107033D2	228	LL107036S2	231
LL107005M3	231	LL107011M3	231	LL107019N	232	LL107033D3	228	LL107036S3	231
LL107005MB	231	LL107011MB	231	LL1070202	233	LL107033DB	228	LL107036SB	231
LL107005MN	231	LL107011MN	231	LL1070203	233	LL107033DN	228	LL107036SN	231
LL107005S2	231	LL107011S2	231	LL107020N	233	LL107033L2	228	LL107037D2	231
LL107005S3	231	LL107011S3	231	LL1070212	233	LL107033L3	228	LL107037D3	231
LL107005SB	231	LL107011SB	231	LL1070213	233	LL107033LB	228	LL107037DB	231
LL107005SN	231	LL107011SN	231	LL107021N	233	LL107033LN	228	LL107037DN	231
LL107006D2	228	LL107012D2	233	LL1070222	232	LL107033M2	228	LL107037L2	231
LL107006D3	228	LL107012D3	233	LL1070223	232	LL107033M3	228	LL107037L3	231
LL107006DB	228	LL107012DN	233	LL107022N	232	LL107033MB	228	LL107037LB	231
LL107006DN	228	LL107012L2	233	LL1070232	232	LL107033MN	228	LL107037LN	231
LL107006L2	228	LL107012L3	233	LL1070233	232	LL107033S2	228	LL107037M2	231
LL107006L3	228	LL107012LN	233	LL107023N	232	LL107033S3	228	LL107037M3	231
LL107006LB	228	LL107012M2	233	LL1070242	229	LL107033SB	228	LL107037MB	231
LL107006LN	228	LL107012M3	233	LL1070243	229	LL107033SN	228	LL107037MN	231
LL107006M2	228	LL107012MN	233	LL107024B	229	LL107034D2	228	LL107037S2	231
LL107006M3	228	LL107012S2	233	LL107024N	229	LL107034D3	228	LL107037S3	231
LL107006MB	228	LL107012S3	233	LL1070252	229	LL107034DB	228	LL107037SB	231
LL107006MN	228	LL107012SN	233	LL1070253	229	LL107034DN	228	LL107037SN	231
LL107006S2	228	LL107013D2	233	LL107025B	229	LL107034L2	228	LL107038D2	231
LL107006S3	228	LL107013D3	233	LL107025N	229	LL107034L3	228	LL107038D3	231
LL107006SB	228	LL107013DN	233	LL1070262	229	LL107034LB	228	LL107038DB	231
LL107006SN	228	LL107013L2	233	LL1070263	229	LL107034LN	228	LL107038DN	231
LL107007D2	229	LL107013L3	233	LL107026B	229	LL107034M2	228	LL107038L2	231
LL107007D3	229	LL107013LN	233	LL107026N	229	LL107034M3	228	LL107038L3	231
LL107007DB	229	LL107013M2	233	LL1070272	229	LL107034MB	228	LL107038LB	231
LL107007DN	229	LL107013M3	233	LL1070273	229	LL107034MN	228	LL107038LN	231
LL107007L2	229	LL107013MN	233	LL107027B	229	LL107034S2	228	LL107038M2	231
LL107007L3	229	LL107013S2	233	LL107027N	229	LL107034S3	228	LL107038M3	231
LL107007LB	229	LL107013S3	233	LL1070282	231	LL107034SB	228	LL107038MB	231
LL107007LN	229	LL107013SN	233	LL1070283	231	LL107034SN	228	LL107038MN	231
LL107007M2	229	LL107016D2	232	LL107028B	231	LL107035D2	228	LL107038S2	231
LL107007M3	229	LL107016D3	232	LL107028N	231	LL107035D3	228	LL107038S3	231
LL107007MB	229	LL107016DN	232	LL1070292	231	LL107035DB	228	LL107038SB	231
LL107007MN	229	LL107016L2	232	LL1070293	231	LL107035DN	228	LL107038SN	231
LL107007S2	229	LL107016L3	232	LL107029B	231	LL107035L2	228	LL107039D2	231
LL107007S3	229	LL107016LN	232	LL107029N	231	LL107035L3	228	LL107039D3	231
LL107007SB	229	LL107016M2	232	LL1070302	233	LL107035LB	228	LL107039DB	231
LL107007SN	229	LL107016M3	232	LL1070303	233	LL107035LN	228	LL107039DN	231
LL1070082	230	LL107016MN	232	LL107030N	233	LL107035M2	228	LL107039L2	231
LL1070083	230	LL107016S2	232	LL1070312	233	LL107035M3	228	LL107039L3	231
LL107008B	230	LL107016S3	232	LL1070313	233	LL107035MB	228	LL107039LB	231
LL107008N	230	LL107016SN	232	LL107031N	233	LL107035MN	228	LL107039LN	231
LL1070092	230	LL107017D2	232	LL107032D2	228	LL107035S2	228	LL107039M2	231
LL1070093	230	LL107017D3	232	LL107032D3	228	LL107035S3	228	LL107039M3	231
LL107009B	230	LL107017DN	232	LL107032DB	228	LL107035SB	228	LL107039MB	231
LL107009N	230	LL107017L2	232	LL107032DN	228	LL107035SN	228	LL107039MN	231



Codice Code Réf.	Pag. Page	Codice Code Réf.	Pag. Page	Codice Code Réf.	Pag. Page	Codice Code Réf.	Pag. Page	Codice Code Réf.	Pag. Page
LL107039S2	231	LL107044MN	233	LL108006N	353	LL108023MN	353	LL108055N	354
LL107039S3	231	LL107044S2	233	LL1080072	353	LL108023S2	353	LL1080562	354
LL107039SB	231	LL107044S3	233	LL1080073	353	LL108023S3	353	LL1080563	354
LL107039SN	231	LL107044SN	233	LL108007N	353	LL108023SN	353	LL108056N	354
LL107040D2	232	LL107045D2	233	LL1080082	353	LL1080242	354	LL108057L2	354
LL107040D3	232	LL107045D3	233	LL1080083	353	LL1080243	354	LL108057L3	354
LL107040DN	232	LL107045DN	233	LL108008N	353	LL108024N	354	LL108057LN	354
LL107040L2	232	LL107045L2	233	LL1080092	353	LL1080252	354	LL108057M2	354
LL107040L3	232	LL107045L3	233	LL1080093	353	LL1080253	354	LL108057M3	354
LL107040LN	232	LL107045LN	233	LL108009N	353	LL108025N	354	LL108057MN	354
LL107040M2	232	LL107045M2	233	LL1080102	353	LL1080262	354	LL108057S2	354
LL107040M3	232	LL107045M3	233	LL1080103	353	LL1080263	354	LL108057S3	354
LL107040MN	232	LL107045MN	233	LL108010N	353	LL108026N	354	LL108057SN	354
LL107040S2	232	LL107045S2	233	LL1080112	353	LL1080272	354	LL108058L2	354
LL107040S3	232	LL107045S3	233	LL1080113	353	LL1080273	354	LL108058L3	354
LL107040SN	232	LL107045SN	233	LL108011N	353	LL108027N	354	LL108058LN	354
LL107041D2	232	LL107046D2	233	LL1080122	353	LL1080322	354	LL108058M2	354
LL107041D3	232	LL107046D3	233	LL1080123	353	LL1080323	354	LL108058M3	354
LL107041DN	232	LL107046DN	233	LL108012N	353	LL108032N	354	LL108058MN	354
LL107041L2	232	LL107046L2	233	LL1080132	353	LL1080332	354	LL108058S2	354
LL107041L3	232	LL107046L3	233	LL1080133	353	LL1080333	354	LL108058S3	354
LL107041LN	232	LL107046LN	233	LL108013N	353	LL108033N	354	LL108058SN	354
LL107041M2	232	LL107046M2	233	LL1080142	353	LL1080342	354	LL108059L2	354
LL107041M3	232	LL107046M3	233	LL1080143	353	LL1080343	354	LL108059L3	354
LL107041MN	232	LL107046MN	233	LL108014N	353	LL108034N	354	LL108059LN	354
LL107041S2	232	LL107046S2	233	LL1080152	353	LL1080352	354	LL108059M2	354
LL107041S3	232	LL107046S3	233	LL1080153	353	LL1080353	354	LL108059M3	354
LL107041SN	232	LL107046SN	233	LL108015N	353	LL108035N	354	LL108059MN	354
LL107042D2	232	LL107047D2	233	LL108020L2	353	LL1080362	354	LL108059S2	354
LL107042D3	232	LL107047D3	233	LL108020L3	353	LL1080363	354	LL108059S3	354
LL107042DN	232	LL107047DN	233	LL108020LN	353	LL108036N	354	LL108059SN	354
LL107042L2	232	LL107047L2	233	LL108020M2	353	LL1080372	354	LL108060L2	354
LL107042L3	232	LL107047L3	233	LL108020M3	353	LL1080373	354	LL108060L3	354
LL107042LN	232	LL107047LN	233	LL108020MN	353	LL108037N	354	LL108060LN	354
LL107042M2	232	LL107047M2	233	LL108020S2	353	LL1080382	354	LL108060M2	354
LL107042M3	232	LL107047M3	233	LL108020S3	353	LL1080383	354	LL108060M3	354
LL107042MN	232	LL107047MN	233	LL108020SN	353	LL108038N	354	LL108060MN	354
LL107042S2	232	LL107047S2	233	LL108021L2	353	LL1080392	354	LL108060S2	354
LL107042S3	232	LL107047S3	233	LL108021L3	353	LL1080393	354	LL108060S3	354
LL107042SN	232	LL107047SN	233	LL108021LN	353	LL108039N	354	LL108060SN	354
LL107043D2	232	LL1080002	353	LL108021M2	353	LL1080492	354	LL1080612	354
LL107043D3	232	LL1080003	353	LL108021M3	353	LL1080493	354	LL1080613	354
LL107043DN	232	LL108000N	353	LL108021MN	353	LL108049N	354	LL108061N	354
LL107043L2	232	LL1080012	353	LL108021S2	353	LL1080502	354	LL1080622	354
LL107043L3	232	LL1080013	353	LL108021S3	353	LL1080503	354	LL1080623	354
LL107043LN	232	LL108001N	353	LL108021SN	353	LL108050N	354	LL108062N	354
LL107043M2	232	LL1080022	353	LL108022L2	353	LL1080512	354	LL1080632	354
LL107043M3	232	LL1080023	353	LL108022L3	353	LL1080513	354	LL1080633	354
LL107043MN	232	LL108002N	353	LL108022LN	353	LL108051N	354	LL108063N	354
LL107043S2	232	LL1080032	353	LL108022M2	353	LL1080522	354	LL1080642	354
LL107043S3	232	LL1080033	353	LL108022M3	353	LL1080523	354	LL1080643	354
LL107043SN	232	LL108003N	353	LL108022MN	353	LL108052N	354	LL108064N	354
LL107044D2	233	LL1080042	353	LL108022S2	353	LL1080532	354	LL1080652	353
LL107044D3	233	LL1080043	353	LL108022S3	353	LL1080533	354	LL1080653	353
LL107044DN	233	LL108004N	353	LL108022SN	353	LL108053N	354	LL108065N	353
LL107044L2	233	LL1080052	353	LL108023L2	353	LL1080542	354	LL1080662	353
LL107044L3	233	LL1080053	353	LL108023L3	353	LL1080543	354	LL1080663	353
LL107044LN	233	LL108005N	353	LL108023LN	353	LL108054N	354	LL108066N	353
LL107044M2	233	LL1080062	353	LL108023M2	353	LL1080552	354	LL1080672	353
LL107044M3	233	LL1080063	353	LL108023M3	353	LL1080553	354	LL1080673	353

# RICERCA ALFANUMERICA PER CODICE

Codice Code Réf.	Pag. Page	Codice Code Réf.	Pag. Page	Codice Code Réf.	Pag. Page	Codice Code Réf.	Pag. Page	Codice Code Réf.	Pag. Page
LL108067N	353	LL1100043	412	LL113006N	140	LL113108N	142	LL113200N	131
LL1080682	353	LL110004N	412	LL1130072	140	LL1131092	142	LL1132012	131
LL1080683	353	LL1100053	412	LL1130073	140	LL1131093	142	LL1132013	131
LL108068N	353	LL110005N	412	LL113007N	140	LL113109N	142	LL113201N	131
LL1080692	353	LL1100063	411	LL1130082	140	LL1131102	142	LL1132022	131
LL1080693	353	LL110006N	411	LL1130083	140	LL1131103	142	LL1132023	131
LL108069N	353	LL1100073	411	LL113008N	140	LL113110N	142	LL113202N	131
LL1080702	353	LL110007N	411	LL1130092	140	LL1131112	142	LL1132032	131
LL1080703	353	LL1100083	411	LL1130093	140	LL1131113	142	LL1132033	131
LL108070N	353	LL110008N	411	LL113009N	140	LL113111N	142	LL113203N	131
LL1080712	353	LL1100093	412	LL1130102	141	LL1131122	131	LL1132052	131
LL1080713	353	LL110009N	412	LL1130103	141	LL1131123	131	LL1132053	131
LL108071N	353	LL1100103	412	LL113010N	141	LL113112N	131	LL113205N	131
LL1080722	353	LL110010N	412	LL1130112	141	LL1131132	131	LL1132062	131
LL1080723	353	LL1100113	412	LL1130113	141	LL1131133	131	LL1132063	131
LL108072N	353	LL110011N	412	LL113011N	141	LL113113N	131	LL113206N	131
LL108073L2	353	LL1100123	411	LL1130122	141	LL1131142	131	LL1132072	131
LL108073L3	353	LL110012N	411	LL1130123	141	LL1131143	131	LL1132073	131
LL108073LN	353	LL1100133	411	LL113012N	141	LL113114N	131	LL113207N	131
LL108073M2	353	LL110013N	411	LL1130132	141	LL1131152	131	LL1132082	131
LL108073M3	353	LL1100143	411	LL1130133	141	LL1131153	131	LL1132083	131
LL108073MN	353	LL110014N	411	LL113013N	141	LL113115N	131	LL113208N	131
LL108073S2	353	LL1100153	412	LL1130142	141	LL1131302	140	LL1150002	148
LL108073S3	353	LL110015N	412	LL1130143	141	LL1131303	140	LL1150003	148
LL108073SN	353	LL1100163	412	LL113014N	141	LL113130N	140	LL115000N	148
LL108074L2	353	LL110016N	412	LL1130152	141	LL1131312	140	LL1150012	148
LL108074L3	353	LL1100173	412	LL1130153	141	LL1131313	140	LL1150013	148
LL108074LN	353	LL110017N	412	LL113015N	141	LL113131N	140	LL115001N	148
LL108074M2	353	LL1100183	411	LL1130162	141	LL1131322	140	LL1150022	148
LL108074M3	353	LL110018N	411	LL1130163	141	LL1131323	140	LL1150023	148
LL108074MN	353	LL1100193	411	LL113016N	141	LL113132N	140	LL115002N	148
LL108074S2	353	LL110019N	411	LL1130172	141	LL1131332	140	LL1150032	148
LL108074S3	353	LL1100203	411	LL1130173	141	LL1131333	140	LL1150033	148
LL108074SN	353	LL110020N	411	LL113017N	141	LL113133N	140	LL115003N	148
LL108075L2	353	LL1100213	411	LL1131002	130	LL1131342	141	LL1150042	148
LL108075L3	353	LL110021N	411	LL1131003	130	LL1131343	141	LL1150043	148
LL108075LN	353	LL1100223	411	LL113100N	130	LL113134N	141	LL115004N	148
LL108075M2	353	LL110022N	411	LL1131012	130	LL1131352	141	LL1150052	148
LL108075M3	353	LL1100233	411	LL1131013	130	LL1131353	141	LL1150053	148
LL108075MN	353	LL110023N	411	LL113101N	130	LL113135N	141	LL115005N	148
LL108075S2	353	LL1130002	130	LL1131022	130	LL1131362	141	LL1150062	148
LL108075S3	353	LL1130003	130	LL1131023	130	LL1131363	141	LL1150063	148
LL108075SN	353	LL113000N	130	LL113102N	130	LL113136N	141	LL115006N	148
LL108076L2	353	LL1130012	130	LL1131032	130	LL1131372	141	LL1150072	148
LL108076L3	353	LL1130013	130	LL1131033	130	LL1131373	141	LL1150073	148
LL108076LN	353	LL113001N	130	LL113103N	130	LL113137N	141	LL115007N	148
LL108076M2	353	LL1130022	140	LL1131042	142	LL1131382	142	LL1150082	159
LL108076M3	353	LL1130023	140	LL1131043	142	LL1131383	142	LL1150083	159
LL108076MN	353	LL113002N	140	LL113104N	142	LL113138N	142	LL115008N	159
LL108076S2	353	LL1130032	140	LL1131052	142	LL1131392	142	LL1150092	159
LL108076S3	353	LL1130033	140	LL1131053	142	LL1131393	142	LL1150093	159
LL108076SN	353	LL113003N	140	LL113105N	142	LL113139N	142	LL115009N	159
LL1100003	411	LL1130042	140	LL1131062	142	LL1131402	142	LL1150102	159
LL110000N	411	LL1130043	140	LL1131063	142	LL1131403	142	LL1150103	159
LL1100013	411	LL113004N	140	LL113106N	142	LL113140N	142	LL115010N	159
LL110001N	411	LL1130052	140	LL1131072	142	LL1131412	142	LL1150112	159
LL1100023	411	LL1130053	140	LL1131073	142	LL1131413	142	LL1150113	159
LL110002N	411	LL113005N	140	LL113107N	142	LL113141N	142	LL115011N	159
LL1100033	412	LL1130062	140	LL1131082	142	LL1132002	131	LL1150122	159
LL110003N	412	LL1130063	140	LL1131083	142	LL1132003	131	LL1150123	159



Codice Code Réf.	Pag. Page	Codice Code Réf.	Pag. Page	Codice Code Réf.	Pag. Page	Codice Code Réf.	Pag. Page	Codice Code Réf.	Pag. Page
LL115012N	159	LL115035N	165	LL115110N	149	LL115131N	167	LL115151N	169
LL1150132	159	LL1150362	165	LL1151112	149	LL1151322	167	LL1151522	169
LL1150133	159	LL1150363	165	LL1151113	149	LL1151323	167	LL1151523	169
LL115013N	159	LL115036N	165	LL115111N	149	LL115132N	167	LL115152N	169
LL1150142	159	LL1150372	165	LL1151132	163	LL1151332	167	LL1151532	169
LL1150143	159	LL1150373	165	LL1151133	163	LL1151333	167	LL1151533	169
LL115014N	159	LL115037N	165	LL115113N	163	LL115133N	167	LL115153N	169
LL1150152	159	LL1150382	165	LL1151142	163	LL1151342	167	LL1151542	169
LL1150153	159	LL1150383	165	LL1151143	163	LL1151343	167	LL1151543	169
LL115015N	159	LL115038N	165	LL115114N	163	LL115134N	167	LL115154N	169
LL1150162	159	LL1150392	165	LL1151152	163	LL1151352	166	LL1151552	169
LL1150163	159	LL1150393	165	LL1151153	163	LL1151353	166	LL1151553	169
LL115016N	159	LL115039N	165	LL115115N	163	LL115135N	166	LL115155N	169
LL1150172	159	LL1150402	165	LL1151162	163	LL1151362	166	LL1151562	169
LL1150173	159	LL1150403	165	LL1151163	163	LL1151363	166	LL1151563	169
LL115017N	159	LL115040N	165	LL115116N	163	LL115136N	166	LL115156N	169
LL1150182	159	LL1150412	165	LL1151172	163	LL1151372	166	LL115166A2	149
LL1150183	159	LL1150413	165	LL1151173	163	LL1151373	166	LL115166A3	149
LL115018N	159	LL115041N	165	LL115117N	163	LL115137N	166	LL115166AN	149
LL1150192	159	LL1150422	169	LL1151182	163	LL1151382	166	LL115166S2	149
LL1150193	159	LL1150423	169	LL1151183	163	LL1151383	166	LL115166S3	149
LL115019N	159	LL115042N	169	LL115118N	163	LL115138N	166	LL115166SN	149
LL1150232	163	LL1150432	169	LL1151192	161	LL1151392	167	LL115166W2	149
LL1150233	163	LL1150433	169	LL1151193	161	LL1151393	167	LL115166W3	149
LL115023N	163	LL115043N	169	LL115119N	161	LL115139N	167	LL115166WN	149
LL1150242	163	LL1150442	169	LL1151202	161	LL1151402	167	LL115167A2	149
LL1150243	163	LL1150443	169	LL1151203	161	LL1151403	167	LL115167A3	149
LL115024N	163	LL115044N	169	LL115120N	161	LL115140N	167	LL115167AN	149
LL1150252	163	LL1151002	148	LL1151212	161	LL1151412	167	LL115167S2	149
LL1150253	163	LL1151003	148	LL1151213	161	LL1151413	167	LL115167S3	149
LL115025N	163	LL115100N	148	LL115121N	161	LL115141N	167	LL115167SN	149
LL1150262	161	LL1151012	148	LL1151222	161	LL1151422	167	LL115167W2	149
LL1150263	161	LL1151013	148	LL1151223	161	LL1151423	167	LL115167W3	149
LL115026N	161	LL115101N	148	LL115122N	161	LL115142N	167	LL115167WN	149
LL1150272	161	LL1151022	148	LL1151232	161	LL1151432	166	LL115168A2	149
LL1150273	161	LL1151023	148	LL1151233	161	LL1151433	166	LL115168A3	149
LL115027N	161	LL115102N	148	LL115123N	161	LL115143N	166	LL115168AN	149
LL1150282	161	LL1151032	148	LL1151242	161	LL1151442	166	LL115168S2	149
LL1150283	161	LL1151033	148	LL1151243	161	LL1151443	166	LL115168S3	149
LL115028N	161	LL115103N	148	LL115124N	161	LL115144N	166	LL115168SN	149
LL1150292	161	LL1151042	149	LL1151252	161	LL1151452	166	LL115168W2	149
LL1150293	161	LL1151043	149	LL1151253	161	LL1151453	166	LL115168W3	149
LL115029N	161	LL115104N	149	LL115125N	161	LL115145N	166	LL115168WN	149
LL1150302	165	LL1151052	149	LL1151262	161	LL1151462	166	LL115169A2	149
LL1150303	165	LL1151053	149	LL1151263	161	LL1151463	166	LL115169A3	149
LL115030N	165	LL115105N	149	LL115126N	161	LL115146N	166	LL115169AN	149
LL1150312	165	LL1151062	149	LL1151272	166	LL1151472	167	LL115169S2	149
LL1150313	165	LL1151063	149	LL1151273	166	LL1151473	167	LL115169S3	149
LL115031N	165	LL115106N	149	LL115127N	166	LL115147N	167	LL115169SN	149
LL1150322	165	LL1151072	149	LL1151282	166	LL1151482	167	LL115169W2	149
LL1150323	165	LL1151073	149	LL1151283	166	LL1151483	167	LL115169W3	149
LL115032N	165	LL115107N	149	LL115128N	166	LL115148N	167	LL115169WN	149
LL1150332	165	LL1151082	149	LL1151292	166	LL1151492	167	LL1160002	34
LL1150333	165	LL1151083	149	LL1151293	166	LL1151493	167	LL1160003	34
LL115033N	165	LL115108N	149	LL115129N	166	LL115149N	167	LL116000N	34
LL1150342	165	LL1151092	149	LL1151302	166	LL1151502	167	LL1160012	34
LL1150343	165	LL1151093	149	LL1151303	166	LL1151503	167	LL1160013	34
LL115034N	165	LL115109N	149	LL115130N	166	LL115150N	167	LL116001N	34
LL1150352	165	LL1151102	149	LL1151312	167	LL1151512	169	LL1160022	34
LL1150353	165	LL1151103	149	LL1151313	167	LL1151513	169	LL1160023	34



# RICERCA ALFANUMERICA PER CODICE

Codice Code Réf.	Pag. Page	Codice Code Réf.	Pag. Page	Codice Code Réf.	Pag. Page	Codice Code Réf.	Pag. Page	Codice Code Réf.	Pag. Page
LL116002N	34	LL116106N	36	LL119002S2	228	LL119007S2	228	LL121006N	340
LL1160032	34	LL1161072	36	LL119002S3	228	LL119007S3	228	LL1210072	340
LL1160033	34	LL1161073	36	LL119002SB	228	LL119007SB	228	LL1210073	340
LL116003N	34	LL116107N	36	LL119002SN	228	LL119007SN	228	LL121007N	340
LL1160042	34	LL1161082	36	LL119003D2	228	LL1200002	374	LL1210082	340
LL1160043	34	LL1161083	36	LL119003D3	228	LL1200003	374	LL1210083	340
LL116004N	34	LL116108N	36	LL119003DB	228	LL120000N	374	LL121008N	340
LL1160052	34	LL1161092	36	LL119003DN	228	LL1200012	374	LL1210092	340
LL1160053	34	LL1161093	36	LL119003M2	228	LL1200013	374	LL1210093	340
LL116005N	34	LL116109N	36	LL119003M3	228	LL120001N	374	LL121009N	340
LL1160062	35	LL1161102	36	LL119003MB	228	LL1200022	374	LL1210102	340
LL1160063	35	LL1161103	36	LL119003MN	228	LL1200023	374	LL1210103	340
LL116006N	35	LL116110N	36	LL119003S2	228	LL120002N	374	LL121010N	340
LL1160072	35	LL1161172	36	LL119003S3	228	LL1200032	374	LL1210112	340
LL1160073	35	LL1161173	36	LL119003SB	228	LL1200033	374	LL1210113	340
LL116007N	35	LL116117N	36	LL119003SN	228	LL120003N	374	LL121011N	340
LL1160082	35	LL1161182	36	LL119004D2	228	LL1200042	374	LL1210122	346
LL1160083	35	LL1161183	36	LL119004D3	228	LL1200043	374	LL1210123	346
LL116008N	35	LL116118N	36	LL119004DB	228	LL120004N	374	LL121012N	346
LL1160092	35	LL1161192	36	LL119004DN	228	LL1200052	374	LL1210132	346
LL1160093	35	LL1161193	36	LL119004M2	228	LL1200053	374	LL1210133	346
LL116009N	35	LL116119N	36	LL119004M3	228	LL120005N	374	LL121013N	346
LL1160102	35	LL1161202	36	LL119004MB	228	LL1200062	374	LL1210142	346
LL1160103	35	LL1161203	36	LL119004MN	228	LL1200063	374	LL1210143	346
LL116010N	35	LL116120N	36	LL119004S2	228	LL120006N	374	LL121014N	346
LL1160172	34	LL1161212	36	LL119004S3	228	LL1200072	374	LL1210152	346
LL1160173	34	LL1161213	36	LL119004SB	228	LL1200073	374	LL1210153	346
LL116017N	34	LL116121N	36	LL119004SN	228	LL120007N	374	LL121015N	346
LL1160182	34	LL119000D2	228	LL119005D2	228	LL1200082	374	LL1210162	346
LL1160183	34	LL119000D3	228	LL119005D3	228	LL1200083	374	LL1210163	346
LL116018N	34	LL119000DB	228	LL119005DB	228	LL120008N	374	LL121016N	346
LL1160192	34	LL119000DN	228	LL119005DN	228	LL1200092	374	LL1210172	346
LL1160193	34	LL119000M2	228	LL119005M2	228	LL1200093	374	LL1210173	346
LL116019N	34	LL119000M3	228	LL119005M3	228	LL120009N	374	LL121017N	346
LL1160202	34	LL119000MB	228	LL119005MB	228	LL1200102	374	LL1210182	346
LL1160203	34	LL119000MN	228	LL119005MN	228	LL1200103	374	LL1210183	346
LL116020N	34	LL119000S2	228	LL119005S2	228	LL120010N	374	LL121018N	346
LL1160212	34	LL119000S3	228	LL119005S3	228	LL1200112	374	LL1210192	346
LL1160213	34	LL119000SB	228	LL119005SB	228	LL1200113	374	LL1210193	346
LL116021N	34	LL119000SN	228	LL119005SN	228	LL120011N	374	LL121019N	346
LL1161002	36	LL119001D2	228	LL119006D2	228	LL1210002	340	LL1210302	346
LL1161003	36	LL119001D3	228	LL119006D3	228	LL1210003	340	LL1210303	346
LL116100N	36	LL119001DB	228	LL119006DB	228	LL121000N	340	LL121030N	346
LL1161012	36	LL119001DN	228	LL119006DN	228	LL1210012	340	LL1210312	346
LL1161013	36	LL119001M2	228	LL119006M2	228	LL1210013	340	LL1210313	346
LL116101N	36	LL119001M3	228	LL119006M3	228	LL121001N	340	LL121031N	346
LL1161022	36	LL119001MB	228	LL119006MB	228	LL1210022	340	LL1210322	346
LL1161023	36	LL119001MN	228	LL119006MN	228	LL1210023	340	LL1210323	346
LL116102N	36	LL119001S2	228	LL119006S2	228	LL121002N	340	LL121032N	346
LL1161032	36	LL119001S3	228	LL119006S3	228	LL1210032	340	LL1210332	346
LL1161033	36	LL119001SB	228	LL119006SB	228	LL1210033	340	LL1210333	346
LL116103N	36	LL119001SN	228	LL119006SN	228	LL121003N	340	LL121033N	346
LL1161042	36	LL119002D2	228	LL119007D2	228	LL1210042	340	LL1220123	296
LL1161043	36	LL119002D3	228	LL119007D3	228	LL1210043	340	LL122012N	296
LL116104N	36	LL119002DB	228	LL119007DB	228	LL121004N	340	LL1220133	296
LL1161052	36	LL119002DN	228	LL119007DN	228	LL1210052	340	LL122013N	296
LL1161053	36	LL119002M2	228	LL119007M2	228	LL1210053	340	LL1220143	296
LL116105N	36	LL119002M3	228	LL119007M3	228	LL121005N	340	LL122014N	296
LL1161062	36	LL119002MB	228	LL119007MB	228	LL1210062	340	LL1220153	296
LL1161063	36	LL119002MN	228	LL119007MN	228	LL1210063	340	LL122015N	296



Codice Code Réf.	Pag. Page	Codice Code Réf.	Pag. Page	Codice Code Réf.	Pag. Page	Codice Code Réf.	Pag. Page	Codice Code Réf.	Pag. Page
LL1220163	296	LL123014N	248	LL124004N	44	LL124024N	44	LL124064N	44
LL122016N	296	LL1230152	249	LL1240052	44	LL1240252	44	LL1240682	45
LL1220173	296	LL1230153	249	LL1240053	44	LL1240253	44	LL1240683	45
LL122017N	296	LL123015N	249	LL124005N	44	LL124025N	44	LL124068N	45
LL1220183	296	LL1230162	249	LL1240062	44	LL1240262	44	LL1240692	45
LL122018N	296	LL1230163	249	LL1240063	44	LL1240263	44	LL1240693	45
LL1220193	296	LL123016N	249	LL124006N	44	LL124026N	44	LL124069N	45
LL122019N	296	LL1230172	249	LL1240072	44	LL1240272	44	LL1240702	45
LL1220203	296	LL1230173	249	LL1240073	44	LL1240273	44	LL1240703	45
LL122020N	296	LL123017N	249	LL124007N	44	LL124027N	44	LL124070N	45
LL1220213	296	LL1230182	249	LL1240082	44	LL1240282	44	LL1240712	45
LL122021N	296	LL1230183	249	LL1240083	44	LL1240283	44	LL1240713	45
LL1220223	296	LL123018N	249	LL124008N	44	LL124028N	44	LL124071N	45
LL122022N	296	LL1230192	249	LL1240092	44	LL1240292	44	LL1240722	45
LL1220233	296	LL1230193	249	LL1240093	44	LL1240293	44	LL1240723	45
LL122023N	296	LL123019N	249	LL124009N	44	LL124029N	44	LL124072N	45
LL1230002	248	LL1230202	249	LL1240102	44	LL1240302	44	LL1240732	45
LL1230003	248	LL1230203	249	LL1240103	44	LL1240303	44	LL1240733	45
LL123000N	248	LL123020N	249	LL124010N	44	LL124030N	44	LL124073N	45
LL1230012	248	LL1230212	249	LL1240112	44	LL1240312	44	LL1240742	45
LL1230013	248	LL1230213	249	LL1240113	44	LL1240313	44	LL1240743	45
LL123001N	248	LL123021N	249	LL124011N	44	LL124031N	44	LL124074N	45
LL1230022	248	LL1230222	249	LL1240122	44	LL1240322	44	LL1240752	45
LL1230023	248	LL1230223	249	LL1240123	44	LL1240323	44	LL1240753	45
LL123002N	248	LL123022N	249	LL124012N	44	LL124032N	44	LL124075N	45
LL1230032	248	LL1230232	249	LL1240132	44	LL1240332	44	LL1240762	45
LL1230033	248	LL1230233	249	LL1240133	44	LL1240333	44	LL1240763	45
LL123003N	248	LL123023N	249	LL124013N	44	LL124033N	44	LL124076N	45
LL1230042	248	LL1230242	249	LL1240142	44	LL1240342	44	LL1240772	45
LL1230043	248	LL1230243	249	LL1240143	44	LL1240343	44	LL1240773	45
LL123004N	248	LL123024N	249	LL124014N	44	LL124034N	44	LL124077N	45
LL1230052	248	LL1230252	249	LL1240152	44	LL1240352	44	LL1250002	380
LL1230053	248	LL1230253	249	LL1240153	44	LL1240353	44	LL1250003	380
LL123005N	248	LL123025N	249	LL124015N	44	LL124035N	44	LL125000N	380
LL1230062	248	LL1230262	249	LL1240162	44	LL1240362	44	LL1250012	380
LL1230063	248	LL1230263	249	LL1240163	44	LL1240363	44	LL1250013	380
LL123006N	248	LL123026N	249	LL124016N	44	LL124036N	44	LL125001N	380
LL1230072	248	LL1230272	249	LL1240172	44	LL1240372	44	LL1250022	380
LL1230073	248	LL1230273	249	LL1240173	44	LL1240373	44	LL1250023	380
LL123007N	248	LL123027N	249	LL124017N	44	LL124037N	44	LL125002N	380
LL1230082	248	LL1230282	249	LL1240182	44	LL1240382	44	LL1250032	380
LL1230083	248	LL1230283	249	LL1240183	44	LL1240383	44	LL1250033	380
LL123008N	248	LL123028N	249	LL124018N	44	LL124038N	44	LL125003N	380
LL1230092	248	LL1230292	249	LL1240192	44	LL1240392	44	LL1250042	380
LL1230093	248	LL1230293	249	LL1240193	44	LL1240393	44	LL1250043	380
LL123009N	248	LL123029N	249	LL124019N	44	LL124039N	44	LL125004N	380
LL1230102	248	LL1240002	44	LL1240202	44	LL1240602	44	LL1250052	380
LL1230103	248	LL1240003	44	LL1240203	44	LL1240603	44	LL1250053	380
LL123010N	248	LL124000N	44	LL124020N	44	LL124060N	44	LL125005N	380
LL1230112	248	LL1240012	44	LL1240212	44	LL1240612	44	LL1250062	380
LL1230113	248	LL1240013	44	LL1240213	44	LL1240613	44	LL1250063	380
LL123011N	248	LL124001N	44	LL124021N	44	LL124061N	44	LL125006N	380
LL1230122	248	LL1240022	44	LL1240222	44	LL1240622	44	LL1250072	380
LL1230123	248	LL1240023	44	LL1240223	44	LL1240623	44	LL1250073	380
LL123012N	248	LL124002N	44	LL124022N	44	LL124062N	44	LL125007N	380
LL1230132	248	LL1240032	44	LL1240232	44	LL1240632	44	LL1250082	381
LL1230133	248	LL1240033	44	LL1240233	44	LL1240633	44	LL1250083	381
LL123013N	248	LL124003N	44	LL124023N	44	LL124063N	44	LL125008N	381
LL1230142	248	LL1240042	44	LL1240242	44	LL1240642	44	LL1250092	381
LL1230143	248	LL1240043	44	LL1240243	44	LL1240643	44	LL1250093	381

# RICERCA ALFANUMERICA PER CODICE

Codice Code Réf.	Pag. Page	Codice Code Réf.	Pag. Page	Codice Code Réf.	Pag. Page	Codice Code Réf.	Pag. Page	Codice Code Réf.	Pag. Page
LL125009N	381	LL125113N	381	LL126004LN	192	LL126013N	202	LL126104LN	193
LL1250102	381	LL1251142	381	LL126004M2	192	LL1260142	202	LL126104M2	193
LL1250103	381	LL1251143	381	LL126004M3	192	LL1260143	202	LL126104M3	193
LL125010N	381	LL125114N	381	LL126004MN	192	LL126014N	202	LL126104MN	193
LL1250112	381	LL1251152	381	LL126004S2	192	LL1260152	202	LL126104S2	193
LL1250113	381	LL1251153	381	LL126004S3	192	LL1260153	202	LL126104S3	193
LL125011N	381	LL125115N	381	LL126004SN	192	LL126015N	202	LL126104SN	193
LL1250122	381	LL126000D2	192	LL126005D2	192	LL126100D2	192	LL126105D2	193
LL1250123	381	LL126000D3	192	LL126005D3	192	LL126100D3	192	LL126105D3	193
LL125012N	381	LL126000DN	192	LL126005DN	192	LL126100DN	192	LL126105DN	193
LL1250132	381	LL126000L2	192	LL126005L2	192	LL126100L2	192	LL126105L2	193
LL1250133	381	LL126000L3	192	LL126005L3	192	LL126100L3	192	LL126105L3	193
LL125013N	381	LL126000LN	192	LL126005LN	192	LL126100LN	192	LL126105LN	193
LL1250142	381	LL126000M2	192	LL126005M2	192	LL126100M2	192	LL126105M2	193
LL1250143	381	LL126000M3	192	LL126005M3	192	LL126100M3	192	LL126105M3	193
LL125014N	381	LL126000MN	192	LL126005MN	192	LL126100MN	192	LL126105MN	193
LL1250152	381	LL126000S2	192	LL126005S2	192	LL126100S2	192	LL126105S2	193
LL1250153	381	LL126000S3	192	LL126005S3	192	LL126100S3	192	LL126105S3	193
LL125015N	381	LL126000SN	192	LL126005SN	192	LL126100SN	192	LL126105SN	193
LL1251002	380	LL126001D2	192	LL126006D2	192	LL126101D2	192	LL126106D2	193
LL1251003	380	LL126001D3	192	LL126006D3	192	LL126101D3	192	LL126106D3	193
LL125100N	380	LL126001DN	192	LL126006DN	192	LL126101DN	192	LL126106DN	193
LL1251012	380	LL126001L2	192	LL126006L2	192	LL126101L2	192	LL126106L2	193
LL1251013	380	LL126001L3	192	LL126006L3	192	LL126101L3	192	LL126106L3	193
LL125101N	380	LL126001LN	192	LL126006LN	192	LL126101LN	192	LL126106LN	193
LL1251022	380	LL126001M2	192	LL126006M2	192	LL126101M2	192	LL126106M2	193
LL1251023	380	LL126001M3	192	LL126006M3	192	LL126101M3	192	LL126106M3	193
LL125102N	380	LL126001MN	192	LL126006MN	192	LL126101MN	192	LL126106MN	193
LL1251032	380	LL126001S2	192	LL126006S2	192	LL126101S2	192	LL126106S2	193
LL1251033	380	LL126001S3	192	LL126006S3	192	LL126101S3	192	LL126106S3	193
LL125103N	380	LL126001SN	192	LL126006SN	192	LL126101SN	192	LL126106SN	193
LL1251042	380	LL126002D2	192	LL126007D2	192	LL126102D2	192	LL126107D2	193
LL1251043	380	LL126002D3	192	LL126007D3	192	LL126102D3	192	LL126107D3	193
LL125104N	380	LL126002DN	192	LL126007DN	192	LL126102DN	192	LL126107DN	193
LL1251052	380	LL126002L2	192	LL126007L2	192	LL126102L2	192	LL126107L2	193
LL1251053	380	LL126002L3	192	LL126007L3	192	LL126102L3	192	LL126107L3	193
LL125105N	380	LL126002LN	192	LL126007LN	192	LL126102LN	192	LL126107LN	193
LL1251062	380	LL126002M2	192	LL126007M2	192	LL126102M2	192	LL126107M2	193
LL1251063	380	LL126002M3	192	LL126007M3	192	LL126102M3	192	LL126107M3	193
LL125106N	380	LL126002MN	192	LL126007MN	192	LL126102MN	192	LL126107MN	193
LL1251072	380	LL126002S2	192	LL126007S2	192	LL126102S2	192	LL126107S2	193
LL1251073	380	LL126002S3	192	LL126007S3	192	LL126102S3	192	LL126107S3	193
LL125107N	380	LL126002SN	192	LL126007SN	192	LL126102SN	192	LL126107SN	193
LL1251082	381	LL126003D2	192	LL1260082	202	LL126103D2	192	LL126200D2	206
LL1251083	381	LL126003D3	192	LL1260083	202	LL126103D3	192	LL126200D3	206
LL125108N	381	LL126003DN	192	LL126008N	202	LL126103DN	192	LL126200DN	206
LL1251092	381	LL126003L2	192	LL1260092	202	LL126103L2	192	LL126200L2	206
LL1251093	381	LL126003L3	192	LL1260093	202	LL126103L3	192	LL126200L3	206
LL125109N	381	LL126003LN	192	LL126009N	202	LL126103LN	192	LL126200LN	206
LL1251102	381	LL126003M2	192	LL1260102	202	LL126103M2	192	LL126200M2	206
LL1251103	381	LL126003M3	192	LL1260103	202	LL126103M3	192	LL126200M3	206
LL125110N	381	LL126003MN	192	LL126010N	202	LL126103MN	192	LL126200MN	206
LL1251112	381	LL126003S2	192	LL1260112	202	LL126103S2	192	LL126200S2	206
LL1251113	381	LL126003S3	192	LL1260113	202	LL126103S3	192	LL126200S3	206
LL125111N	381	LL126003SN	192	LL126011N	202	LL126103SN	192	LL126200SN	206
LL1251122	381	LL126004D2	192	LL1260122	202	LL126104D2	193	LL126201D2	206
LL1251123	381	LL126004D3	192	LL1260123	202	LL126104D3	193	LL126201D3	206
LL125112N	381	LL126004DN	192	LL126012N	202	LL126104DN	193	LL126201DN	206
LL1251132	381	LL126004L2	192	LL1260132	202	LL126104L2	193	LL126201L2	206
LL1251133	381	LL126004L3	192	LL1260133	202	LL126104L3	193	LL126201L3	206

# A-Z search by code

## Recherche alpha-numerique par référence



Codice Code Réf.	Pag. Page	Codice Code Réf.	Pag. Page	Codice Code Réf.	Pag. Page	Codice Code Réf.	Pag. Page	Codice Code Réf.	Pag. Page
LL126201LN	206	LL126206LN	206	LL126319N	210	LL128015N	96	LL128063N	94
LL126201M2	206	LL126206M2	206	LL1263202	210	LL1280162	96	LL1280642	95
LL126201M3	206	LL126206M3	206	LL1263203	210	LL1280163	96	LL1280643	95
LL126201MN	206	LL126206MN	206	LL126320N	210	LL128016N	96	LL128064N	95
LL126201S2	206	LL126206S2	206	LL1263212	210	LL1280172	96	LL1280652	95
LL126201S3	206	LL126206S3	206	LL1263213	210	LL1280173	96	LL1280653	95
LL126201SN	206	LL126206SN	206	LL126321N	210	LL128017N	96	LL128065N	95
LL126202D2	206	LL126207D2	206	LL1263222	210	LL1280182	96	LL1280662	95
LL126202D3	206	LL126207D3	206	LL1263223	210	LL1280183	96	LL1280663	95
LL126202DN	206	LL126207DN	206	LL126322N	210	LL128018N	96	LL128066N	95
LL126202L2	206	LL126207L2	206	LL1263232	210	LL1280202	96	LL1280672	95
LL126202L3	206	LL126207L3	206	LL1263233	210	LL1280203	96	LL1280673	95
LL126202LN	206	LL126207LN	206	LL126323N	210	LL128020N	96	LL128067N	95
LL126202M2	206	LL126207M2	206	LL1280002	94	LL1280232	94	LL1280682	96
LL126202M3	206	LL126207M3	206	LL1280003	94	LL1280233	94	LL1280683	96
LL126202MN	206	LL126207MN	206	LL128000N	94	LL128023N	94	LL128068N	96
LL126202S2	206	LL126207S2	206	LL1280012	94	LL1280242	94	LL1280692	96
LL126202S3	206	LL126207S3	206	LL1280013	94	LL1280243	94	LL1280693	96
LL126202SN	206	LL126207SN	206	LL128001N	94	LL128024N	94	LL128069N	96
LL126203D2	206	LL1263002	210	LL1280022	94	LL1280322	95	LL1280702	96
LL126203D3	206	LL1263003	210	LL1280023	94	LL1280323	95	LL1280703	96
LL126203DN	206	LL126300N	210	LL128002N	94	LL128032N	95	LL128070N	96
LL126203L2	206	LL1263012	210	LL1280032	94	LL1280332	95	LL1280712	96
LL126203L3	206	LL1263013	210	LL1280033	94	LL1280333	95	LL1280713	96
LL126203LN	206	LL126301N	210	LL128003N	94	LL128033N	95	LL128071N	96
LL126203M2	206	LL1263022	210	LL1280042	94	LL1280472	97	LL1280722	97
LL126203M3	206	LL1263023	210	LL1280043	94	LL1280473	97	LL1280723	97
LL126203MN	206	LL126302N	210	LL128004N	94	LL128047N	97	LL128072N	97
LL126203S2	206	LL1263032	211	LL1280052	94	LL1280482	97	LL1280732	97
LL126203S3	206	LL1263033	211	LL1280053	94	LL1280483	97	LL1280733	97
LL126203SN	206	LL126303N	211	LL128005N	94	LL128048N	97	LL128073N	97
LL126204D2	206	LL1263042	211	LL1280062	95	LL1280492	97	LL1280742	97
LL126204D3	206	LL1263043	211	LL1280063	95	LL1280493	97	LL1280743	97
LL126204DN	206	LL126304N	211	LL128006N	95	LL128049N	97	LL128074N	97
LL126204L2	206	LL1263052	211	LL1280072	95	LL1280502	97	LL1280752	97
LL126204L3	206	LL1263053	211	LL1280073	95	LL1280503	97	LL1280753	97
LL126204LN	206	LL126305N	211	LL128007N	95	LL128050N	97	LL128075N	97
LL126204M2	206	LL1263092	211	LL1280082	95	LL1280512	97	LL12810E2	98
LL126204M3	206	LL1263093	211	LL1280083	95	LL1280513	97	LL12810E3	98
LL126204MN	206	LL126309N	211	LL128008N	95	LL128051N	97	LL12810EN	98
LL126204S2	206	LL1263102	211	LL1280092	95	LL1280522	97	LL12810G2	98
LL126204S3	206	LL1263103	211	LL1280093	95	LL1280523	97	LL12810G3	98
LL126204SN	206	LL126310N	211	LL128009N	95	LL128052N	97	LL12810GN	98
LL126205D2	206	LL1263112	211	LL1280102	95	LL1280532	97	LL12810K2	98
LL126205D3	206	LL1263113	211	LL1280103	95	LL1280533	97	LL12810K3	98
LL126205DN	206	LL126311N	211	LL128010N	95	LL128053N	97	LL12810KN	98
LL126205L2	206	LL1263122	211	LL1280112	95	LL1280542	97	LL12810W2	98
LL126205L3	206	LL1263123	211	LL1280113	95	LL1280543	97	LL12810W3	98
LL126205LN	206	LL126312N	211	LL128011N	95	LL128054N	97	LL12810WN	98
LL126205M2	206	LL1263132	211	LL1280122	96	LL1280602	94	LL12811E2	98
LL126205M3	206	LL1263133	211	LL1280123	96	LL1280603	94	LL12811E3	98
LL126205MN	206	LL126313N	211	LL128012N	96	LL128060N	94	LL12811EN	98
LL126205S2	206	LL1263142	211	LL1280132	96	LL1280612	94	LL12811G2	98
LL126205S3	206	LL1263143	211	LL1280133	96	LL1280613	94	LL12811G3	98
LL126205SN	206	LL126314N	211	LL128013N	96	LL128061N	94	LL12811GN	98
LL126206D2	206	LL1263182	210	LL1280142	96	LL1280622	94	LL12811K2	98
LL126206D3	206	LL1263183	210	LL1280143	96	LL1280623	94	LL12811K3	98
LL126206DN	206	LL126318N	210	LL128014N	96	LL128062N	94	LL12811KN	98
LL126206L2	206	LL1263192	210	LL1280152	96	LL1280632	94	LL12811W2	98
LL126206L3	206	LL1263193	210	LL1280153	96	LL1280633	94	LL12811W3	98

# RICERCA ALFANUMERICA PER CODICE

Codice Code Réf.	Pag. Page	Codice Code Réf.	Pag. Page	Codice Code Réf.	Pag. Page	Codice Code Réf.	Pag. Page	Codice Code Réf.	Pag. Page
LL12811WN	98	LL12816WN	100	LL12821WN	101	LL129019N	362	LL129119N	363
LL12812E2	98	LL12817E2	100	LL1290002	362	LL1291002	362	LL1292002	370
LL12812E3	98	LL12817E3	100	LL1290003	362	LL1291003	362	LL1292003	370
LL12812EN	98	LL12817EN	100	LL129000N	362	LL129100N	362	LL129200N	370
LL12812G2	98	LL12817G2	100	LL1290012	362	LL1291012	362	LL1292012	370
LL12812G3	98	LL12817G3	100	LL1290013	362	LL1291013	362	LL1292013	370
LL12812GN	98	LL12817GN	100	LL129001N	362	LL129101N	362	LL129201N	370
LL12812K2	98	LL12817K2	100	LL1290022	362	LL1291022	362	LL1292022	370
LL12812K3	98	LL12817K3	100	LL1290023	362	LL1291023	362	LL1292023	370
LL12812KN	98	LL12817KN	100	LL129002N	362	LL129102N	362	LL129202N	370
LL12812W2	98	LL12817W2	100	LL1290032	362	LL1291032	362	LL1292032	370
LL12812W3	98	LL12817W3	100	LL1290033	362	LL1291033	362	LL1292033	370
LL12812WN	98	LL12817WN	100	LL129003N	362	LL129103N	362	LL129203N	370
LL12813E2	99	LL12818E2	100	LL1290042	362	LL1291042	362	LL1292042	370
LL12813E3	99	LL12818E3	100	LL1290043	362	LL1291043	362	LL1292043	370
LL12813EN	99	LL12818EN	100	LL129004N	362	LL129104N	362	LL129204N	370
LL12813G2	99	LL12818G2	100	LL1290052	362	LL1291052	362	LL1292052	370
LL12813G3	99	LL12818G3	100	LL1290053	362	LL1291053	362	LL1292053	370
LL12813GN	99	LL12818GN	100	LL129005N	362	LL129105N	362	LL129205N	370
LL12813K2	99	LL12818K2	100	LL1290062	362	LL1291062	362	LL1292062	370
LL12813K3	99	LL12818K3	100	LL1290063	362	LL1291063	362	LL1292063	370
LL12813KN	99	LL12818KN	100	LL129006N	362	LL129106N	362	LL129206N	370
LL12813W2	99	LL12818W2	100	LL1290072	362	LL1291072	362	LL1292072	370
LL12813W3	99	LL12818W3	100	LL1290073	362	LL1291073	362	LL1292073	370
LL12813WN	99	LL12818WN	100	LL129007N	362	LL129107N	362	LL129207N	370
LL12814E2	99	LL12819E2	101	LL1290082	362	LL1291082	363	LL1293012	370
LL12814E3	99	LL12819E3	101	LL1290083	362	LL1291083	363	LL1293013	370
LL12814EN	99	LL12819EN	101	LL129008N	362	LL129108N	363	LL129301N	370
LL12814G2	99	LL12819G2	101	LL1290092	362	LL1291092	363	LL1293022	370
LL12814G3	99	LL12819G3	101	LL1290093	362	LL1291093	363	LL1293023	370
LL12814GN	99	LL12819GN	101	LL129009N	362	LL129109N	363	LL129302N	370
LL12814K2	99	LL12819K2	101	LL1290102	362	LL1291102	363	LL1293032	370
LL12814K3	99	LL12819K3	101	LL1290103	362	LL1291103	363	LL1293033	370
LL12814KN	99	LL12819KN	101	LL129010N	362	LL129110N	363	LL129303N	370
LL12814W2	99	LL12819W2	101	LL1290112	362	LL1291112	363	LL1293042	370
LL12814W3	99	LL12819W3	101	LL1290113	362	LL1291113	363	LL1293043	370
LL12814WN	99	LL12819WN	101	LL129011N	362	LL129111N	363	LL129304N	370
LL12815E2	99	LL12820E2	101	LL1290122	362	LL1291122	363	LL1293052	370
LL12815E3	99	LL12820E3	101	LL1290123	362	LL1291123	363	LL1293053	370
LL12815EN	99	LL12820EN	101	LL129012N	362	LL129112N	363	LL129305N	370
LL12815G2	99	LL12820G2	101	LL1290132	362	LL1291132	363	LL1293062	370
LL12815G3	99	LL12820G3	101	LL1290133	362	LL1291133	363	LL1293063	370
LL12815GN	99	LL12820GN	101	LL129013N	362	LL129113N	363	LL129306N	370
LL12815K2	99	LL12820K2	101	LL1290142	362	LL1291142	363	LL1293072	370
LL12815K3	99	LL12820K3	101	LL1290143	362	LL1291143	363	LL1293073	370
LL12815KN	99	LL12820KN	101	LL129014N	362	LL129114N	363	LL129307N	370
LL12815W2	99	LL12820W2	101	LL1290152	362	LL1291152	363	LL1293082	370
LL12815W3	99	LL12820W3	101	LL1290153	362	LL1291153	363	LL1293083	370
LL12815WN	99	LL12820WN	101	LL129015N	362	LL129115N	363	LL129308N	370
LL12816E2	100	LL12821E2	101	LL1290162	362	LL1291162	363	LL1300002	70
LL12816E3	100	LL12821E3	101	LL1290163	362	LL1291163	363	LL1300003	70
LL12816EN	100	LL12821EN	101	LL129016N	362	LL129116N	363	LL130000N	70
LL12816G2	100	LL12821G2	101	LL1290172	362	LL1291172	363	LL1300012	70
LL12816G3	100	LL12821G3	101	LL1290173	362	LL1291173	363	LL1300013	70
LL12816GN	100	LL12821GN	101	LL129017N	362	LL129117N	363	LL130001N	70
LL12816K2	100	LL12821K2	101	LL1290182	362	LL1291182	363	LL1300022	70
LL12816K3	100	LL12821K3	101	LL1290183	362	LL1291183	363	LL1300023	70
LL12816KN	100	LL12821KN	101	LL129018N	362	LL129118N	363	LL130002N	70
LL12816W2	100	LL12821W2	101	LL1290192	362	LL1291192	363	LL1300042	70
LL12816W3	100	LL12821W3	101	LL1290193	362	LL1291193	363	LL1300043	70





Codice Code Réf.	Pag. Page	Codice Code Réf.	Pag. Page	Codice Code Réf.	Pag. Page	Codice Code Réf.	Pag. Page	Codice Code Réf.	Pag. Page
LL130004N	70	LL132001SN	220	LL132008MN	220	LL133002LN	176	LL133008LN	176
LL1300052	70	LL132002L2	220	LL132008S2	220	LL133002M2	176	LL133008M2	176
LL1300053	70	LL132002L3	220	LL132008S3	220	LL133002M3	176	LL133008M3	176
LL130005N	70	LL132002LN	220	LL132008SN	220	LL133002MN	176	LL133008MN	176
LL1300062	70	LL132002M2	220	LL132009L2	220	LL133002S2	176	LL133008S2	176
LL1300063	70	LL132002M3	220	LL132009L3	220	LL133002S3	176	LL133008S3	176
LL130006N	70	LL132002MN	220	LL132009LN	220	LL133002SN	176	LL133008SN	176
LL1300072	70	LL132002S2	220	LL132009M2	220	LL133003D2	176	LL133009L2	176
LL1300073	70	LL132002S3	220	LL132009M3	220	LL133003D3	176	LL133009L3	176
LL130007N	70	LL132002SN	220	LL132009MN	220	LL133003DN	176	LL133009LN	176
LL1300082	70	LL132003L2	220	LL132009S2	220	LL133003L2	176	LL133009M2	176
LL1300083	70	LL132003L3	220	LL132009S3	220	LL133003L3	176	LL133009M3	176
LL130008N	70	LL132003LN	220	LL132009SN	220	LL133003LN	176	LL133009MN	176
LL131000A2	254	LL132003M2	220	LL132010L2	220	LL133003M2	176	LL133009S2	176
LL131000A3	254	LL132003M3	220	LL132010L3	220	LL133003M3	176	LL133009S3	176
LL131000AN	254	LL132003MN	220	LL132010LN	220	LL133003MN	176	LL133009SN	176
LL131000B2	254	LL132003S2	220	LL132010M2	220	LL133003S2	176	LL133010D2	176
LL131000B3	254	LL132003S3	220	LL132010M3	220	LL133003S3	176	LL133010D3	176
LL131000BN	254	LL132003SN	220	LL132010MN	220	LL133003SN	176	LL133010DN	176
LL131000D2	254	LL132004L2	220	LL132010S2	220	LL133004D2	176	LL133010L2	176
LL131000D3	254	LL132004L3	220	LL132010S3	220	LL133004D3	176	LL133010L3	176
LL131000DN	254	LL132004LN	220	LL132010SN	220	LL133004DN	176	LL133010LN	176
LL131000M2	254	LL132004M2	220	LL132011L2	220	LL133004L2	176	LL133010M2	176
LL131000M3	254	LL132004M3	220	LL132011L3	220	LL133004L3	176	LL133010M3	176
LL131000MN	254	LL132004MN	220	LL132011LN	220	LL133004LN	176	LL133010MN	176
LL131000S2	254	LL132004S2	220	LL132011M2	220	LL133004M2	176	LL133010S2	176
LL131000S3	254	LL132004S3	220	LL132011M3	220	LL133004M3	176	LL133010S3	176
LL131000SN	254	LL132004SN	220	LL132011MN	220	LL133004MN	176	LL133010SN	176
LL131100A2	254	LL132005L2	220	LL132011S2	220	LL133004S2	176	LL133011D2	176
LL131100A3	254	LL132005L3	220	LL132011S3	220	LL133004S3	176	LL133011D3	176
LL131100AN	254	LL132005LN	220	LL132011SN	220	LL133004SN	176	LL133011DN	176
LL131100B2	254	LL132005M2	220	LL133000D2	176	LL133005L2	176	LL133011L2	176
LL131100B3	254	LL132005M3	220	LL133000D3	176	LL133005L3	176	LL133011L3	176
LL131100BN	254	LL132005MN	220	LL133000DN	176	LL133005LN	176	LL133011LN	176
LL131100D2	254	LL132005S2	220	LL133000L2	176	LL133005M2	176	LL133011M2	176
LL131100D3	254	LL132005S3	220	LL133000L3	176	LL133005M3	176	LL133011M3	176
LL131100DN	254	LL132005SN	220	LL133000LN	176	LL133005MN	176	LL133011MN	176
LL131100M2	254	LL132006L2	220	LL133000M2	176	LL133005S2	176	LL133011S2	176
LL131100M3	254	LL132006L3	220	LL133000M3	176	LL133005S3	176	LL133011S3	176
LL131100MN	254	LL132006LN	220	LL133000MN	176	LL133005SN	176	LL133011SN	176
LL131100S2	254	LL132006M2	220	LL133000S2	176	LL133006L2	176	LL133012D2	176
LL131100S3	254	LL132006M3	220	LL133000S3	176	LL133006L3	176	LL133012D3	176
LL131100SN	254	LL132006MN	220	LL133000SN	176	LL133006LN	176	LL133012DN	176
LL132000L2	220	LL132006S2	220	LL133001D2	176	LL133006M2	176	LL133012L2	176
LL132000L3	220	LL132006S3	220	LL133001D3	176	LL133006M3	176	LL133012L3	176
LL132000LN	220	LL132006SN	220	LL133001DN	176	LL133006MN	176	LL133012LN	176
LL132000M2	220	LL132007L2	220	LL133001L2	176	LL133006S2	176	LL133012M2	176
LL132000M3	220	LL132007L3	220	LL133001L3	176	LL133006S3	176	LL133012M3	176
LL132000MN	220	LL132007LN	220	LL133001LN	176	LL133006SN	176	LL133012MN	176
LL132000S2	220	LL132007M2	220	LL133001M2	176	LL133007L2	176	LL133012S2	176
LL132000S3	220	LL132007M3	220	LL133001M3	176	LL133007L3	176	LL133012S3	176
LL132000SN	220	LL132007MN	220	LL133001MN	176	LL133007LN	176	LL133012SN	176
LL132001L2	220	LL132007S2	220	LL133001S2	176	LL133007M2	176	LL133013D2	176
LL132001L3	220	LL132007S3	220	LL133001S3	176	LL133007M3	176	LL133013D3	176
LL132001LN	220	LL132007SN	220	LL133001SN	176	LL133007MN	176	LL133013DN	176
LL132001M2	220	LL132008L2	220	LL133002D2	176	LL133007S2	176	LL133013L2	176
LL132001M3	220	LL132008L3	220	LL133002D3	176	LL133007S3	176	LL133013L3	176
LL132001MN	220	LL132008LN	220	LL133002DN	176	LL133007SN	176	LL133013LN	176
LL132001S2	220	LL132008M2	220	LL133002L2	176	LL133008L2	176	LL133013M2	176
LL132001S3	220	LL132008M3	220	LL133002L3	176	LL133008L3	176	LL133013M3	176

# RICERCA ALFANUMERICA PER CODICE

Codice Code Réf.	Pag. Page	Codice Code Réf.	Pag. Page	Codice Code Réf.	Pag. Page	Codice Code Réf.	Pag. Page	Codice Code Réf.	Pag. Page
LL133013MN	176	LL133019SN	176	LL133024SN	177	LL133031DN	177	LL133036MN	177
LL133013S2	176	LL133020D2	177	LL133025L2	177	LL133031L2	177	LL133036S2	177
LL133013S3	176	LL133020D3	177	LL133025L3	177	LL133031L3	177	LL133036S3	177
LL133013SN	176	LL133020DN	177	LL133025LN	177	LL133031LN	177	LL133036SN	177
LL133014D2	176	LL133020L2	177	LL133025M2	177	LL133031M2	177	LL133037L2	177
LL133014D3	176	LL133020L3	177	LL133025M3	177	LL133031M3	177	LL133037L3	177
LL133014DN	176	LL133020LN	177	LL133025MN	177	LL133031MN	177	LL133037LN	177
LL133014L2	176	LL133020M2	177	LL133025S2	177	LL133031S2	177	LL133037M2	177
LL133014L3	176	LL133020M3	177	LL133025S3	177	LL133031S3	177	LL133037M3	177
LL133014LN	176	LL133020MN	177	LL133025SN	177	LL133031SN	177	LL133037MN	177
LL133014M2	176	LL133020S2	177	LL133026L2	177	LL133032D2	177	LL133037S2	177
LL133014M3	176	LL133020S3	177	LL133026L3	177	LL133032D3	177	LL133037S3	177
LL133014MN	176	LL133020SN	177	LL133026LN	177	LL133032DN	177	LL133037SN	177
LL133014S2	176	LL133021D2	177	LL133026M2	177	LL133032L2	177	LL133038L2	177
LL133014S3	176	LL133021D3	177	LL133026M3	177	LL133032L3	177	LL133038L3	177
LL133014SN	176	LL133021DN	177	LL133026MN	177	LL133032LN	177	LL133038LN	177
LL133015L2	176	LL133021L2	177	LL133026S2	177	LL133032M2	177	LL133038M2	177
LL133015L3	176	LL133021L3	177	LL133026S3	177	LL133032M3	177	LL133038M3	177
LL133015LN	176	LL133021LN	177	LL133026SN	177	LL133032MN	177	LL133038MN	177
LL133015M2	176	LL133021M2	177	LL133027L2	177	LL133032S2	177	LL133038S2	177
LL133015M3	176	LL133021M3	177	LL133027L3	177	LL133032S3	177	LL133038S3	177
LL133015MN	176	LL133021MN	177	LL133027LN	177	LL133032SN	177	LL133038SN	177
LL133015S2	176	LL133021S2	177	LL133027M2	177	LL133033D2	177	LL133039L2	177
LL133015S3	176	LL133021S3	177	LL133027M3	177	LL133033D3	177	LL133039L3	177
LL133015SN	176	LL133021SN	177	LL133027MN	177	LL133033DN	177	LL133039LN	177
LL133016L2	176	LL133022D2	177	LL133027S2	177	LL133033L2	177	LL133039M2	177
LL133016L3	176	LL133022D3	177	LL133027S3	177	LL133033L3	177	LL133039M3	177
LL133016LN	176	LL133022DN	177	LL133027SN	177	LL133033LN	177	LL133039MN	177
LL133016M2	176	LL133022L2	177	LL133028L2	177	LL133033M2	177	LL133039S2	177
LL133016M3	176	LL133022L3	177	LL133028L3	177	LL133033M3	177	LL133039S3	177
LL133016MN	176	LL133022LN	177	LL133028LN	177	LL133033MN	177	LL133039SN	177
LL133016S2	176	LL133022M2	177	LL133028M2	177	LL133033S2	177	LL133040D2	178
LL133016S3	176	LL133022M3	177	LL133028M3	177	LL133033S3	177	LL133040D3	178
LL133016SN	176	LL133022MN	177	LL133028MN	177	LL133033SN	177	LL133040DN	178
LL133017L2	176	LL133022S2	177	LL133028S2	177	LL133034D2	177	LL133040L2	178
LL133017L3	176	LL133022S3	177	LL133028S3	177	LL133034D3	177	LL133040L3	178
LL133017LN	176	LL133022SN	177	LL133028SN	177	LL133034DN	177	LL133040LN	178
LL133017M2	176	LL133023D2	177	LL133029L2	177	LL133034L2	177	LL133040M2	178
LL133017M3	176	LL133023D3	177	LL133029L3	177	LL133034L3	177	LL133040M3	178
LL133017MN	176	LL133023DN	177	LL133029LN	177	LL133034LN	177	LL133040MN	178
LL133017S2	176	LL133023L2	177	LL133029M2	177	LL133034M2	177	LL133040S2	178
LL133017S3	176	LL133023L3	177	LL133029M3	177	LL133034M3	177	LL133040S3	178
LL133017SN	176	LL133023LN	177	LL133029MN	177	LL133034MN	177	LL133040SN	178
LL133018L2	176	LL133023M2	177	LL133029S2	177	LL133034S2	177	LL133041D2	178
LL133018L3	176	LL133023M3	177	LL133029S3	177	LL133034S3	177	LL133041D3	178
LL133018LN	176	LL133023MN	177	LL133029SN	177	LL133034SN	177	LL133041DN	178
LL133018M2	176	LL133023S2	177	LL133030D2	177	LL133035L2	177	LL133041L2	178
LL133018M3	176	LL133023S3	177	LL133030D3	177	LL133035L3	177	LL133041L3	178
LL133018MN	176	LL133023SN	177	LL133030DN	177	LL133035LN	177	LL133041LN	178
LL133018S2	176	LL133024D2	177	LL133030L2	177	LL133035M2	177	LL133041M2	178
LL133018S3	176	LL133024D3	177	LL133030L3	177	LL133035M3	177	LL133041M3	178
LL133018SN	176	LL133024DN	177	LL133030LN	177	LL133035MN	177	LL133041MN	178
LL133019L2	176	LL133024L2	177	LL133030M2	177	LL133035S2	177	LL133041S2	178
LL133019L3	176	LL133024L3	177	LL133030M3	177	LL133035S3	177	LL133041S3	178
LL133019LN	176	LL133024LN	177	LL133030MN	177	LL133035SN	177	LL133041SN	178
LL133019M2	176	LL133024M2	177	LL133030S2	177	LL133036L2	177	LL133042D2	178
LL133019M3	176	LL133024M3	177	LL133030S3	177	LL133036L3	177	LL133042D3	178
LL133019MN	176	LL133024MN	177	LL133030SN	177	LL133036LN	177	LL133042DN	178
LL133019S2	176	LL133024S2	177	LL133031D2	177	LL133036M2	177	LL133042L2	178
LL133019S3	176	LL133024S3	177	LL133031D3	177	LL133036M3	177	LL133042L3	178



Codice Code Réf.	Pag. Page	Codice Code Réf.	Pag. Page	Codice Code Réf.	Pag. Page	Codice Code Réf.	Pag. Page	Codice Code Réf.	Pag. Page
LL133042LN	178	LL133048LN	178	LL133053SN	178	LL134013N	54	LL1350172	83
LL133042M2	178	LL133048M2	178	LL133054L2	178	LL1340142	54	LL1350173	83
LL133042M3	178	LL133048M3	178	LL133054L3	178	LL1340143	54	LL135017N	83
LL133042MN	178	LL133048MN	178	LL133054LN	178	LL134014N	54	LL1350182	83
LL133042S2	178	LL133048S2	178	LL133054M2	178	LL1340152	54	LL1350183	83
LL133042S3	178	LL133048S3	178	LL133054M3	178	LL1340153	54	LL135018N	83
LL133042SN	178	LL133048SN	178	LL133054MN	178	LL134015N	54	LL1350192	83
LL133043D2	178	LL133049D2	178	LL133054S2	178	LL1340162	56	LL1350193	83
LL133043D3	178	LL133049D3	178	LL133054S3	178	LL1340163	56	LL135019N	83
LL133043DN	178	LL133049DN	178	LL133054SN	178	LL134016N	56	LL1351002	82
LL133043L2	178	LL133049L2	178	LL133055L2	178	LL1340172	56	LL1351003	82
LL133043L3	178	LL133049L3	178	LL133055L3	178	LL1340173	56	LL135100N	82
LL133043LN	178	LL133049LN	178	LL133055LN	178	LL134017N	56	LL1351012	82
LL133043M2	178	LL133049M2	178	LL133055M2	178	LL1340182	56	LL1351013	82
LL133043M3	178	LL133049M3	178	LL133055M3	178	LL1340183	56	LL135101N	82
LL133043MN	178	LL133049MN	178	LL133055MN	178	LL134018N	56	LL1351022	82
LL133043S2	178	LL133049S2	178	LL133055S2	178	LL1340192	56	LL1351023	82
LL133043S3	178	LL133049S3	178	LL133055S3	178	LL1340193	56	LL135102N	82
LL133043SN	178	LL133049SN	178	LL133055SN	178	LL134019N	56	LL1351032	82
LL133044L2	178	LL133050D2	178	LL1340002	54	LL1340202	56	LL1351033	82
LL133044L3	178	LL133050D3	178	LL1340003	54	LL1340203	56	LL135103N	82
LL133044LN	178	LL133050DN	178	LL134000N	54	LL134020N	56	LL1351042	83
LL133044M2	178	LL133050L2	178	LL1340012	54	LL1340212	56	LL1351043	83
LL133044M3	178	LL133050L3	178	LL1340013	54	LL1340213	56	LL135104N	83
LL133044MN	178	LL133050LN	178	LL134001N	54	LL134021N	56	LL1351052	83
LL133044S2	178	LL133050M2	178	LL1340022	54	LL1340222	56	LL1351053	83
LL133044S3	178	LL133050M3	178	LL1340023	54	LL1340223	56	LL135105N	83
LL133044SN	178	LL133050MN	178	LL134002N	54	LL134022N	56	LL1351062	83
LL133045L2	178	LL133050S2	178	LL1340032	54	LL1340232	56	LL1351063	83
LL133045L3	178	LL133050S3	178	LL1340033	54	LL1340233	56	LL135106N	83
LL133045LN	178	LL133050SN	178	LL134003N	54	LL134023N	56	LL1351072	83
LL133045M2	178	LL133051D2	178	LL1340042	55	LL134B3	402	LL1351073	83
LL133045M3	178	LL133051D3	178	LL1340043	55	LL134BN	402	LL135107N	83
LL133045MN	178	LL133051DN	178	LL134004N	55	LL1350002	82	LL1351162	83
LL133045S2	178	LL133051L2	178	LL1340052	55	LL1350003	82	LL1351163	83
LL133045S3	178	LL133051L3	178	LL1340053	55	LL135000N	82	LL135116N	83
LL133045SN	178	LL133051LN	178	LL134005N	55	LL1350012	82	LL1351172	83
LL133046L2	178	LL133051M2	178	LL1340062	55	LL1350013	82	LL1351173	83
LL133046L3	178	LL133051M3	178	LL1340063	55	LL135001N	82	LL135117N	83
LL133046LN	178	LL133051MN	178	LL134006N	55	LL1350022	82	LL1351182	83
LL133046M2	178	LL133051S2	178	LL1340072	55	LL1350023	82	LL1351183	83
LL133046M3	178	LL133051S3	178	LL1340073	55	LL135002N	82	LL135118N	83
LL133046MN	178	LL133051SN	178	LL134007N	55	LL1350032	82	LL1351192	83
LL133046S2	178	LL133052L2	178	LL1340082	55	LL1350033	82	LL1351193	83
LL133046S3	178	LL133052L3	178	LL1340083	55	LL135003N	82	LL135119N	83
LL133046SN	178	LL133052LN	178	LL134008N	55	LL1350042	82	LL135AL3	403
LL133047L2	178	LL133052M2	178	LL1340092	55	LL1350043	82	LL135ALN	403
LL133047L3	178	LL133052M3	178	LL1340093	55	LL135004N	82	LL135AM3	403
LL133047LN	178	LL133052MN	178	LL134009N	55	LL1350052	82	LL135AMN	403
LL133047M2	178	LL133052S2	178	LL1340102	55	LL1350053	82	LL135AS3	403
LL133047M3	178	LL133052S3	178	LL1340103	55	LL135005N	82	LL135ASN	403
LL133047MN	178	LL133052SN	178	LL134010N	55	LL1350062	82	LL135B3	403
LL133047S2	178	LL133053L2	178	LL1340112	55	LL1350063	82	LL135BN	403
LL133047S3	178	LL133053L3	178	LL1340113	55	LL135006N	82	LL136000L2	260
LL133047SN	178	LL133053LN	178	LL134011N	55	LL1350072	82	LL136000L3	260
LL133048D2	178	LL133053M2	178	LL1340122	54	LL1350073	82	LL136000LN	260
LL133048D3	178	LL133053M3	178	LL1340123	54	LL135007N	82	LL136000M2	260
LL133048DN	178	LL133053MN	178	LL134012N	54	LL1350162	83	LL136000M3	260
LL133048L2	178	LL133053S2	178	LL1340132	54	LL1350163	83	LL136000N	260
LL133048L3	178	LL133053S3	178	LL1340133	54	LL135016N	83	LL136000S2	260

# RICERCA ALFANUMERICA PER CODICE

Codice Code Réf.	Pag. Page	Codice Code Réf.	Pag. Page	Codice Code Réf.	Pag. Page	Codice Code Réf.	Pag. Page	Codice Code Réf.	Pag. Page
LL136000S3	260	LL13703W3	241	LL14000ED3	114	LL14001GD3	116	LL14010KD3	115
LL136000SN	260	LL13703WN	241	LL14000EDN	114	LL14001GDN	116	LL14010KDN	115
LL1370002	240	LL1370402	241	LL14000ES2	114	LL14001GS2	116	LL14010KS2	115
LL1370003	240	LL1370403	241	LL14000ES3	114	LL14001GS3	116	LL14010KS3	115
LL137000N	240	LL137040N	241	LL14000ESN	114	LL14001GSN	116	LL14010KSN	115
LL13700E2	240	LL13704E2	241	LL14000EW2	114	LL14001GW2	116	LL14010KW2	115
LL13700E3	240	LL13704E3	241	LL14000EW3	114	LL14001GW3	116	LL14010KW3	115
LL13700EN	240	LL13704EN	241	LL14000EWN	114	LL14001GWN	116	LL14010KWN	115
LL13700G2	240	LL13704G2	241	LL14000GA2	114	LL14001KA2	116	LL14010WA2	115
LL13700G3	240	LL13704G3	241	LL14000GA3	114	LL14001KA3	116	LL14010WA3	115
LL13700GN	240	LL13704GN	241	LL14000GAN	114	LL14001KAN	116	LL14010WAN	115
LL13700K2	240	LL13704K2	241	LL14000GD2	114	LL14001KD2	116	LL14010WD2	115
LL13700K3	240	LL13704K3	241	LL14000GD3	114	LL14001KD3	116	LL14010WD3	115
LL13700KN	240	LL13704KN	241	LL14000GDN	114	LL14001KDN	116	LL14010WDN	115
LL13700W2	240	LL13704W2	241	LL14000GS2	114	LL14001KS2	116	LL14010WS2	115
LL13700W3	240	LL13704W3	241	LL14000GS3	114	LL14001KS3	116	LL14010WS3	115
LL13700WN	240	LL13704WN	241	LL14000GSN	114	LL14001KSN	116	LL14010WSN	115
LL1370102	240	LL1380002	264	LL14000GW2	114	LL14001KW2	116	LL14010WW2	115
LL1370103	240	LL1380003	264	LL14000GW3	114	LL14001KW3	116	LL14010WW3	115
LL137010N	240	LL138000N	264	LL14000GWN	114	LL14001KWN	116	LL14010WWN	115
LL13701E2	240	LL1380012	264	LL14000KA2	114	LL14001WA2	116	LL14011EA2	117
LL13701E3	240	LL1380013	264	LL14000KA3	114	LL14001WA3	116	LL14011EA3	117
LL13701EN	240	LL138001N	264	LL14000KAN	114	LL14001WAN	116	LL14011EAN	117
LL13701G2	240	LL1380022	264	LL14000KD2	114	LL14001WD2	116	LL14011ED2	117
LL13701G3	240	LL1380023	264	LL14000KD3	114	LL14001WD3	116	LL14011ED3	117
LL13701GN	240	LL138002N	264	LL14000KDN	114	LL14001WDN	116	LL14011EDN	117
LL13701K2	240	LL1380032	264	LL14000KS2	114	LL14001WS2	116	LL14011ES2	117
LL13701K3	240	LL1380033	264	LL14000KS3	114	LL14001WS3	116	LL14011ES3	117
LL13701KN	240	LL138003N	264	LL14000KSN	114	LL14001WSN	116	LL14011ESN	117
LL13701W2	240	LL1380042	265	LL14000KW2	114	LL14001WW2	116	LL14011EW2	117
LL13701W3	240	LL1380043	265	LL14000KW3	114	LL14001WW3	116	LL14011EW3	117
LL13701WN	240	LL138004N	265	LL14000KWN	114	LL14001WWN	116	LL14011EWN	117
LL1370202	240	LL1381002	265	LL14000WA2	114	LL14010EA2	115	LL14011GA2	117
LL1370203	240	LL1381003	265	LL14000WA3	114	LL14010EA3	115	LL14011GA3	117
LL137020N	240	LL138100N	265	LL14000WAN	114	LL14010EAN	115	LL14011GAN	117
LL13702E2	240	LL1381012	265	LL14000WD2	114	LL14010ED2	115	LL14011GD2	117
LL13702E3	240	LL1381013	265	LL14000WD3	114	LL14010ED3	115	LL14011GD3	117
LL13702EN	240	LL138101N	265	LL14000WDN	114	LL14010EDN	115	LL14011GDN	117
LL13702G2	240	LL1381022	265	LL14000WS2	114	LL14010ES2	115	LL14011GS2	117
LL13702G3	240	LL1381023	265	LL14000WS3	114	LL14010ES3	115	LL14011GS3	117
LL13702GN	240	LL138102N	265	LL14000WSN	114	LL14010ESN	115	LL14011GSN	117
LL13702K2	240	LL1381032	266	LL14000WW2	114	LL14010EW2	115	LL14011GW2	117
LL13702K3	240	LL1381033	266	LL14000WW3	114	LL14010EW3	115	LL14011GW3	117
LL13702KN	240	LL138103N	266	LL14000WWN	114	LL14010EWN	115	LL14011GWN	117
LL13702W2	240	LL1381042	266	LL14001EA2	116	LL14010GA2	115	LL14011KA2	117
LL13702W3	240	LL1381043	266	LL14001EA3	116	LL14010GA3	115	LL14011KA3	117
LL13702WN	240	LL138104N	266	LL14001EAN	116	LL14010GAN	115	LL14011KAN	117
LL1370302	241	LL1391002	274	LL14001ED2	116	LL14010GD2	115	LL14011KD2	117
LL1370303	241	LL1391003	274	LL14001ED3	116	LL14010GD3	115	LL14011KD3	117
LL137030N	241	LL139100N	274	LL14001EDN	116	LL14010GDN	115	LL14011KDN	117
LL13703E2	241	LL1392002	274	LL14001ES2	116	LL14010GS2	115	LL14011KS2	117
LL13703E3	241	LL1392003	274	LL14001ES3	116	LL14010GS3	115	LL14011KS3	117
LL13703EN	241	LL139200N	274	LL14001ESN	116	LL14010GSN	115	LL14011KSN	117
LL13703G2	241	LL1393002	274	LL14001EW2	116	LL14010GW2	115	LL14011KW2	117
LL13703G3	241	LL1393003	274	LL14001EW3	116	LL14010GW3	115	LL14011KW3	117
LL13703GN	241	LL139300N	274	LL14001EWN	116	LL14010GWN	115	LL14011KWN	117
LL13703K2	241	LL14000EA2	114	LL14001GA2	116	LL14010KA2	115	LL14011WA2	117
LL13703K3	241	LL14000EA3	114	LL14001GA3	116	LL14010KA3	115	LL14011WA3	117
LL13703KN	241	LL14000EAN	114	LL14001GAN	116	LL14010KAN	115	LL14011WAN	117
LL13703W2	241	LL14000ED2	114	LL14001GD2	116	LL14010KD2	115	LL14011WD2	117



Codice Code Réf.	Pag. Page	Codice Code Réf.	Pag. Page	Codice Code Réf.	Pag. Page	Codice Code Réf.	Pag. Page	Codice Code Réf.	Pag. Page
LL14011WD3	117	LL14021WD3	117	LL14031ED3	116	LL14302L3	318	LL14400Y3	26
LL14011WDN	117	LL14021WDN	117	LL14031EDN	116	LL14302LN	318	LL14400YN	26
LL14011WS2	117	LL14021WS2	117	LL14031ES2	116	LL14302W2	318	LL14400Z2	26
LL14011WS3	117	LL14021WS3	117	LL14031ES3	116	LL14302W3	318	LL14400Z3	26
LL14011WSN	117	LL14021WSN	117	LL14031ESN	116	LL14302WN	318	LL14400ZN	26
LL14011WW2	117	LL14021WW2	117	LL14031EW2	116	LL14302Z2	318	LL1440102	27
LL14011WW3	117	LL14021WW3	117	LL14031EW3	116	LL14302Z3	318	LL1440103	27
LL14011WWN	117	LL14021WWN	117	LL14031EWN	116	LL14302ZN	318	LL144010N	27
LL14020E2	115	LL14030EA2	114	LL14031GA2	116	LL14303D2	318	LL14401E2	27
LL14020E3	115	LL14030EA3	114	LL14031GA3	116	LL14303D3	318	LL14401E3	27
LL14020EN	115	LL14030EAN	114	LL14031GAN	116	LL14303DN	318	LL14401EN	27
LL14020G2	115	LL14030ED2	114	LL14031GD2	116	LL14303L2	318	LL14401G2	27
LL14020G3	115	LL14030ED3	114	LL14031GD3	116	LL14303L3	318	LL14401G3	27
LL14020GN	115	LL14030EDN	114	LL14031GDN	116	LL14303LN	318	LL14401GN	27
LL14020K2	115	LL14030ES2	114	LL14031GS2	116	LL14303W2	318	LL14401K2	27
LL14020K3	115	LL14030ES3	114	LL14031GS3	116	LL14303W3	318	LL14401K3	27
LL14020KN	115	LL14030ESN	114	LL14031GSN	116	LL14303WN	318	LL14401KN	27
LL14020W2	115	LL14030EW2	114	LL14031GW2	116	LL14303Z2	318	LL14401U2	27
LL14020W3	115	LL14030EW3	114	LL14031GW3	116	LL14303Z3	318	LL14401U3	27
LL14020WN	115	LL14030EWN	114	LL14031GWN	116	LL14303ZN	318	LL14401UN	27
LL14021EA2	117	LL14030GA2	114	LL14031KA2	116	LL14304D2	319	LL14401Y2	27
LL14021EA3	117	LL14030GA3	114	LL14031KA3	116	LL14304D3	319	LL14401Y3	27
LL14021EAN	117	LL14030GAN	114	LL14031KAN	116	LL14304DN	319	LL14401YN	27
LL14021ED2	117	LL14030GD2	114	LL14031KD2	116	LL14304L2	319	LL14401Z2	27
LL14021ED3	117	LL14030GD3	114	LL14031KD3	116	LL14304L3	319	LL14401Z3	27
LL14021EDN	117	LL14030GDN	114	LL14031KDN	116	LL14304LN	319	LL14401ZN	27
LL14021ES2	117	LL14030GS2	114	LL14031KS2	116	LL14304W2	319	LL14501D2	328
LL14021ES3	117	LL14030GS3	114	LL14031KS3	116	LL14304W3	319	LL14501D3	328
LL14021ESN	117	LL14030GSN	114	LL14031KSN	116	LL14304WN	319	LL14501DN	328
LL14021EW2	117	LL14030GW2	114	LL14031KW2	116	LL14304Z2	319	LL14501K2	328
LL14021EW3	117	LL14030GW3	114	LL14031KW3	116	LL14304Z3	319	LL14501K3	328
LL14021EWN	117	LL14030GWN	114	LL14031KWN	116	LL14304ZN	319	LL14501KN	328
LL14021GA2	117	LL14030KA2	114	LL14031WA2	116	LL14305D2	319	LL14501L2	328
LL14021GA3	117	LL14030KA3	114	LL14031WA3	116	LL14305D3	319	LL14501L3	328
LL14021GAN	117	LL14030KAN	114	LL14031WAN	116	LL14305DN	319	LL14501LN	328
LL14021GD2	117	LL14030KD2	114	LL14031WD2	116	LL14305L2	319	LL14501W2	328
LL14021GD3	117	LL14030KD3	114	LL14031WD3	116	LL14305L3	319	LL14501W3	328
LL14021GDN	117	LL14030KDN	114	LL14031WDN	116	LL14305LN	319	LL14501WN	328
LL14021GS2	117	LL14030KS2	114	LL14031WS2	116	LL14305W2	319	LL14501Z2	328
LL14021GS3	117	LL14030KS3	114	LL14031WS3	116	LL14305W3	319	LL14501Z3	328
LL14021GSN	117	LL14030KSN	114	LL14031WSN	116	LL14305WN	319	LL14501ZN	328
LL14021GW2	117	LL14030KW2	114	LL14031WW2	116	LL14305Z2	319	LL14502D2	328
LL14021GW3	117	LL14030KW3	114	LL14031WW3	116	LL14305Z3	319	LL14502D3	328
LL14021GWN	117	LL14030KWN	114	LL14031WWN	116	LL14305ZN	319	LL14502DN	328
LL14021KA2	117	LL14030WA2	114	LL14301D2	318	LL14400O2	26	LL14502K2	328
LL14021KA3	117	LL14030WA3	114	LL14301D3	318	LL14400O3	26	LL14502K3	328
LL14021KAN	117	LL14030WAN	114	LL14301DN	318	LL14400ON	26	LL14502KN	328
LL14021KD2	117	LL14030WD2	114	LL14301L2	318	LL14400E2	26	LL14502L2	328
LL14021KD3	117	LL14030WD3	114	LL14301L3	318	LL14400E3	26	LL14502L3	328
LL14021KDN	117	LL14030WDN	114	LL14301LN	318	LL14400EN	26	LL14502LN	328
LL14021KS2	117	LL14030WS2	114	LL14301W2	318	LL14400G2	26	LL14502W2	328
LL14021KS3	117	LL14030WS3	114	LL14301W3	318	LL14400G3	26	LL14502W3	328
LL14021KSN	117	LL14030WSN	114	LL14301WN	318	LL14400GN	26	LL14502WN	328
LL14021KW2	117	LL14030WW2	114	LL14301Z2	318	LL14400K2	26	LL14502Z2	328
LL14021KW3	117	LL14030WW3	114	LL14301Z3	318	LL14400K3	26	LL14502Z3	328
LL14021KWN	117	LL14030WWN	114	LL14301ZN	318	LL14400KN	26	LL14502ZN	328
LL14021WA2	117	LL14031EA2	116	LL14302D2	318	LL14400U2	26	LL14503D2	329
LL14021WA3	117	LL14031EA3	116	LL14302D3	318	LL14400U3	26	LL14503D3	329
LL14021WAN	117	LL14031EAN	116	LL14302DN	318	LL14400UN	26	LL14503DN	329
LL14021WD2	117	LL14031ED2	116	LL14302L2	318	LL14400Y2	26	LL14503K2	329



# RICERCA ALFANUMERICA PER CODICE

Codice Code Réf.	Pag. Page	Codice Code Réf.	Pag. Page	Codice Code Réf.	Pag. Page	Codice Code Réf.	Pag. Page	Codice Code Réf.	Pag. Page
LL14503K3	329	LL14521K3	328	LL14600GD3	284	LL14601GS3	284	LL14602UM3	285
LL14503KN	329	LL14521KN	328	LL14600GDN	284	LL14601GSN	284	LL14602UMN	285
LL14503L2	329	LL14521L2	328	LL14600GM2	284	LL14601UD2	284	LL14602US2	285
LL14503L3	329	LL14521L3	328	LL14600GM3	284	LL14601UD3	284	LL14602US3	285
LL14503LN	329	LL14521LN	328	LL14600GMN	284	LL14601UDN	284	LL14602USN	285
LL14503W2	329	LL14521W2	328	LL14600GS2	284	LL14601UM2	284	LL14602WD2	285
LL14503W3	329	LL14521W3	328	LL14600GS3	284	LL14601UM3	284	LL14602WD3	285
LL14503WN	329	LL14521WN	328	LL14600GSN	284	LL14601UMN	284	LL14602WDN	285
LL14503Z2	329	LL14521Z2	328	LL14600GD2	284	LL14601US2	284	LL14602WM2	285
LL14503Z3	329	LL14521Z3	328	LL14600UD3	284	LL14601US3	284	LL14602WM3	285
LL14503ZN	329	LL14521ZN	328	LL14600UDN	284	LL14601USN	284	LL14602WMN	285
LL14511D2	328	LL14522D2	328	LL14600UM2	284	LL14601WD2	284	LL14602WS2	285
LL14511D3	328	LL14522D3	328	LL14600UM3	284	LL14601WD3	284	LL14602WS3	285
LL14511DN	328	LL14522DN	328	LL14600UMN	284	LL14601WDN	284	LL14602WSN	285
LL14511K2	328	LL14522K2	328	LL14600US2	284	LL14601WM2	284	LL14602ZD2	285
LL14511K3	328	LL14522K3	328	LL14600US3	284	LL14601WM3	284	LL14602ZD3	285
LL14511KN	328	LL14522KN	328	LL14600USN	284	LL14601WMN	284	LL14602ZDN	285
LL14511L2	328	LL14522L2	328	LL14600WD2	284	LL14601WS2	284	LL14602ZM2	285
LL14511L3	328	LL14522L3	328	LL14600WD3	284	LL14601WS3	284	LL14602ZM3	285
LL14511LN	328	LL14522LN	328	LL14600WDN	284	LL14601WSN	284	LL14602ZMN	285
LL14511W2	328	LL14522W2	328	LL14600WM2	284	LL14601ZD2	284	LL14602ZS2	285
LL14511W3	328	LL14522W3	328	LL14600WM3	284	LL14601ZD3	284	LL14602ZS3	285
LL14511WN	328	LL14522WN	328	LL14600WMN	284	LL14601ZDN	284	LL14602ZSN	285
LL14511Z2	328	LL14522Z2	328	LL14600WS2	284	LL14601ZM2	284	LL14603AD2	286
LL14511Z3	328	LL14522Z3	328	LL14600WS3	284	LL14601ZM3	284	LL14603AD3	286
LL14511ZN	328	LL14522ZN	328	LL14600WSN	284	LL14601ZMN	284	LL14603ADN	286
LL14512D2	328	LL14523D2	329	LL14600ZD2	284	LL14601ZS2	284	LL14603AM2	286
LL14512D3	328	LL14523D3	329	LL14600ZD3	284	LL14601ZS3	284	LL14603AM3	286
LL14512DN	328	LL14523DN	329	LL14600ZDN	284	LL14601ZSN	284	LL14603AMN	286
LL14512K2	328	LL14523K2	329	LL14600ZM2	284	LL14602AD2	285	LL14603AS2	286
LL14512K3	328	LL14523K3	329	LL14600ZM3	284	LL14602AD3	285	LL14603AS3	286
LL14512KN	328	LL14523KN	329	LL14600ZMN	284	LL14602ADN	285	LL14603ASN	286
LL14512L2	328	LL14523L2	329	LL14600ZS2	284	LL14602AM2	285	LL14603BD2	286
LL14512L3	328	LL14523L3	329	LL14600ZS3	284	LL14602AM3	285	LL14603BD3	286
LL14512LN	328	LL14523LN	329	LL14600ZSN	284	LL14602AMN	285	LL14603BDN	286
LL14512W2	328	LL14523W2	329	LL14601AD2	284	LL14602AS2	285	LL14603BM2	286
LL14512W3	328	LL14523W3	329	LL14601AD3	284	LL14602AS3	285	LL14603BM3	286
LL14512WN	328	LL14523WN	329	LL14601ADN	284	LL14602ASN	285	LL14603BMN	286
LL14512Z2	328	LL14523Z2	329	LL14601AM2	284	LL14602BD2	285	LL14603BS2	286
LL14512Z3	328	LL14523Z3	329	LL14601AM3	284	LL14602BD3	285	LL14603BS3	286
LL14512ZN	328	LL14523ZN	329	LL14601AMN	284	LL14602BDN	285	LL14603BSN	286
LL14513D2	329	LL14600AD2	284	LL14601AS2	284	LL14602BM2	285	LL14603GD2	286
LL14513D3	329	LL14600AD3	284	LL14601AS3	284	LL14602BM3	285	LL14603GD3	286
LL14513DN	329	LL14600ADN	284	LL14601ASN	284	LL14602BMN	285	LL14603GDN	286
LL14513K2	329	LL14600AM2	284	LL14601BD2	284	LL14602BS2	285	LL14603GM2	286
LL14513K3	329	LL14600AM3	284	LL14601BD3	284	LL14602BS3	285	LL14603GM3	286
LL14513KN	329	LL14600AMN	284	LL14601BDN	284	LL14602BSN	285	LL14603GMN	286
LL14513L2	329	LL14600AS2	284	LL14601BM2	284	LL14602GD2	285	LL14603GS2	286
LL14513L3	329	LL14600AS3	284	LL14601BM3	284	LL14602GD3	285	LL14603GS3	286
LL14513LN	329	LL14600ASN	284	LL14601BMN	284	LL14602GDN	285	LL14603GSN	286
LL14513W2	329	LL14600BD2	284	LL14601BS2	284	LL14602GM2	285	LL14603UD2	286
LL14513W3	329	LL14600BD3	284	LL14601BS3	284	LL14602GM3	285	LL14603UD3	286
LL14513WN	329	LL14600BDN	284	LL14601BSN	284	LL14602GMN	285	LL14603UDN	286
LL14513Z2	329	LL14600BM2	284	LL14601GD2	284	LL14602GS2	285	LL14603UM2	286
LL14513Z3	329	LL14600BM3	284	LL14601GD3	284	LL14602GS3	285	LL14603UM3	286
LL14513ZN	329	LL14600BMN	284	LL14601GDN	284	LL14602GSN	285	LL14603UMN	286
LL14521D2	328	LL14600BS2	284	LL14601GM2	284	LL14602UD2	285	LL14603US2	286
LL14521D3	328	LL14600BS3	284	LL14601GM3	284	LL14602UD3	285	LL14603US3	286
LL14521DN	328	LL14600BSN	284	LL14601GMN	284	LL14602UDN	285	LL14603USN	286
LL14521K2	328	LL14600GD2	284	LL14601GS2	284	LL14602UM2	285	LL14603WD2	286



Codice Code Réf.	Pag. Page	Codice Code Réf.	Pag. Page	Codice Code Réf.	Pag. Page	Codice Code Réf.	Pag. Page	Codice Code Réf.	Pag. Page
LL14603WD3	286	LL14604WS3	285	LL14605ZM3	286	LL14701BE3	302	LL14703WE3	302
LL14603WDN	286	LL14604WSN	285	LL14605ZMN	286	LL14701BEN	302	LL14703WEN	302
LL14603WM2	286	LL14604ZD2	285	LL14605ZS2	286	LL14701BL2	302	LL14703WL2	302
LL14603WM3	286	LL14604ZD3	285	LL14605ZS3	286	LL14701BL3	302	LL14703WL3	302
LL14603WMN	286	LL14604ZDN	285	LL14605ZSN	286	LL14701BLN	302	LL14703WLN	302
LL14603WS2	286	LL14604ZM2	285	LL14606AD2	287	LL14701BM2	302	LL14703WM2	302
LL14603WS3	286	LL14604ZM3	285	LL14606AD3	287	LL14701BM3	302	LL14703WM3	302
LL14603WSN	286	LL14604ZMN	285	LL14606ADN	287	LL14701BMN	302	LL14703WMN	302
LL14603ZD2	286	LL14604ZS2	285	LL14606AM2	287	LL14701BS2	302	LL14703WS2	302
LL14603ZD3	286	LL14604ZS3	285	LL14606AM3	287	LL14701BS3	302	LL14703WS3	302
LL14603ZDN	286	LL14604ZSN	285	LL14606AMN	287	LL14701BSN	302	LL14703WSN	302
LL14603ZM2	286	LL14605AD2	286	LL14606AS2	287	LL14701WE2	302	LL14705DE2	308
LL14603ZM3	286	LL14605AD3	286	LL14606AS3	287	LL14701WE3	302	LL14705DE3	308
LL14603ZMN	286	LL14605ADN	286	LL14606ASN	287	LL14701WEN	302	LL14705DEN	308
LL14603ZS2	286	LL14605AM2	286	LL14606BD2	287	LL14701WL2	302	LL14705DL2	308
LL14603ZS3	286	LL14605AM3	286	LL14606BD3	287	LL14701WL3	302	LL14705DL3	308
LL14603ZSN	286	LL14605AMN	286	LL14606BDN	287	LL14701WLN	302	LL14705DLN	308
LL14604AD2	285	LL14605AS2	286	LL14606BM2	287	LL14701WM2	302	LL14705DM2	308
LL14604AD3	285	LL14605AS3	286	LL14606BM3	287	LL14701WM3	302	LL14705DM3	308
LL14604ADN	285	LL14605ASN	286	LL14606BMN	287	LL14701WMN	302	LL14705DMN	308
LL14604AM2	285	LL14605BD2	286	LL14606BS2	287	LL14701WS2	302	LL14705DS2	308
LL14604AM3	285	LL14605BD3	286	LL14606BS3	287	LL14701WS3	302	LL14705DS3	308
LL14604AMN	285	LL14605BDN	286	LL14606BSN	287	LL14701WSN	302	LL14705DSN	308
LL14604AS2	285	LL14605BM2	286	LL14606GD2	287	LL14702BE2	302	LL14705KE2	308
LL14604AS3	285	LL14605BM3	286	LL14606GD3	287	LL14702BE3	302	LL14705KE3	308
LL14604ASN	285	LL14605BMN	286	LL14606GDN	287	LL14702BEN	302	LL14705KEN	308
LL14604BD2	285	LL14605BS2	286	LL14606GM2	287	LL14702BL2	302	LL14705KL2	308
LL14604BD3	285	LL14605BS3	286	LL14606GM3	287	LL14702BL3	302	LL14705KL3	308
LL14604BDN	285	LL14605BSN	286	LL14606GMN	287	LL14702BLN	302	LL14705KLN	308
LL14604BM2	285	LL14605GD2	286	LL14606GS2	287	LL14702BM2	302	LL14705KM2	308
LL14604BM3	285	LL14605GD3	286	LL14606GS3	287	LL14702BM3	302	LL14705KM3	308
LL14604BMN	285	LL14605GDN	286	LL14606GSN	287	LL14702BMN	302	LL14705KMN	308
LL14604BS2	285	LL14605GM2	286	LL14606UD2	287	LL14702BS2	302	LL14705KS2	308
LL14604BS3	285	LL14605GM3	286	LL14606UD3	287	LL14702BS3	302	LL14705KS3	308
LL14604BSN	285	LL14605GMN	286	LL14606UDN	287	LL14702BSN	302	LL14705KSN	308
LL14604GD2	285	LL14605GS2	286	LL14606UM2	287	LL14702WE2	302	LL14705LE2	308
LL14604GD3	285	LL14605GS3	286	LL14606UM3	287	LL14702WE3	302	LL14705LE3	308
LL14604GDN	285	LL14605GSN	286	LL14606UMN	287	LL14702WEN	302	LL14705LEN	308
LL14604GM2	285	LL14605UD2	286	LL14606US2	287	LL14702WL2	302	LL14705LL2	308
LL14604GM3	285	LL14605UD3	286	LL14606US3	287	LL14702WL3	302	LL14705LL3	308
LL14604GMN	285	LL14605UDN	286	LL14606USN	287	LL14702WLN	302	LL14705LLN	308
LL14604GS2	285	LL14605UM2	286	LL14606WD2	287	LL14702WM2	302	LL14705LM2	308
LL14604GS3	285	LL14605UM3	286	LL14606WD3	287	LL14702WM3	302	LL14705LM3	308
LL14604GSN	285	LL14605UMN	286	LL14606WDN	287	LL14702WMN	302	LL14705LMN	308
LL14604UD2	285	LL14605US2	286	LL14606WM2	287	LL14702WS2	302	LL14705LS2	308
LL14604UD3	285	LL14605US3	286	LL14606WM3	287	LL14702WS3	302	LL14705LS3	308
LL14604UDN	285	LL14605USN	286	LL14606WMN	287	LL14702WSN	302	LL14705LSN	308
LL14604UM2	285	LL14605WD2	286	LL14606WS2	287	LL14703BE2	302	LL14705WE2	308
LL14604UM3	285	LL14605WD3	286	LL14606WS3	287	LL14703BE3	302	LL14705WE3	308
LL14604UMN	285	LL14605WDN	286	LL14606WSN	287	LL14703BEN	302	LL14705WEN	308
LL14604US2	285	LL14605WM2	286	LL14606ZD2	287	LL14703BL2	302	LL14705WL2	308
LL14604US3	285	LL14605WM3	286	LL14606ZD3	287	LL14703BL3	302	LL14705WL3	308
LL14604USN	285	LL14605WMN	286	LL14606ZDN	287	LL14703BLN	302	LL14705WLN	308
LL14604WD2	285	LL14605WS2	286	LL14606ZM2	287	LL14703BM2	302	LL14705WM2	308
LL14604WD3	285	LL14605WS3	286	LL14606ZM3	287	LL14703BM3	302	LL14705WM3	308
LL14604WDN	285	LL14605WSN	286	LL14606ZMN	287	LL14703BMN	302	LL14705WMN	308
LL14604WM2	285	LL14605ZD2	286	LL14606ZS2	287	LL14703BS2	302	LL14705WS2	308
LL14604WM3	285	LL14605ZD3	286	LL14606ZS3	287	LL14703BS3	302	LL14705WS3	308
LL14604WMN	285	LL14605ZDN	286	LL14606ZSN	287	LL14703BSN	302	LL14705WSN	308
LL14604WS2	285	LL14605ZM2	286	LL14701BE2	302	LL14703WE2	302	LL14706DE2	308

# RICERCA ALFANUMERICA PER CODICE

Codice Code Réf.	Pag. Page	Codice Code Réf.	Pag. Page	Codice Code Réf.	Pag. Page	Codice Code Réf.	Pag. Page	Codice Code Réf.	Pag. Page
LL14706DE3	308	LL14707KE3	314	LL4900083	352	LL493EM3	352	LL496EM3	352
LL14706DEN	308	LL14707KEN	314	LL490008N	352	LL493EMN	352	LL496EMN	352
LL14706DL2	308	LL14707KL2	314	LL4900092	352	LL493ES2	352	LL496ES2	352
LL14706DL3	308	LL14707KL3	314	LL4900093	352	LL493ES3	352	LL496ES3	352
LL14706DLN	308	LL14707KLN	314	LL490009N	352	LL493ESN	352	LL496ESN	352
LL14706DM2	308	LL14707KM2	314	LL4900102	352	LL493GL2	352	LL496GL2	352
LL14706DM3	308	LL14707KM3	314	LL4900103	352	LL493GL3	352	LL496GL3	352
LL14706DMN	308	LL14707KMN	314	LL490010N	352	LL493GLN	352	LL496GLN	352
LL14706DS2	308	LL14707KS2	314	LL4900112	352	LL493GM2	352	LL496GM2	352
LL14706DS3	308	LL14707KS3	314	LL4900113	352	LL493GM3	352	LL496GM3	352
LL14706DSN	308	LL14707KSN	314	LL490011N	352	LL493GMN	352	LL496GMN	352
LL14706KE2	308	LL14707LE2	314	LL4900122	352	LL493GS2	352	LL496GS2	352
LL14706KE3	308	LL14707LE3	314	LL4900123	352	LL493GS3	352	LL496GS3	352
LL14706KEN	308	LL14707LEN	314	LL490012N	352	LL493GSN	352	LL496GSN	352
LL14706KL2	308	LL14707LL2	314	LL4900132	352	LL493KL2	352	LL496KL2	352
LL14706KL3	308	LL14707LL3	314	LL4900133	352	LL493KL3	352	LL496KL3	352
LL14706KLN	308	LL14707LLN	314	LL490013N	352	LL493KLN	352	LL496KLN	352
LL14706KM2	308	LL14707LM2	314	LL4900142	352	LL493KM2	352	LL496KM2	352
LL14706KM3	308	LL14707LM3	314	LL4900143	352	LL493KM3	352	LL496KM3	352
LL14706KMN	308	LL14707LMN	314	LL490014N	352	LL493KMN	352	LL496KMN	352
LL14706KS2	308	LL14707LS2	314	LL4900152	352	LL493KS2	352	LL496KS2	352
LL14706KS3	308	LL14707LS3	314	LL4900153	352	LL493KS3	352	LL496KS3	352
LL14706KSN	308	LL14707LSN	314	LL490015N	352	LL493KSN	352	LL496KSN	352
LL14706LE2	308	LL14707WE2	314	LL49112	352	LL49412	352	LL581B13	431
LL14706LE3	308	LL14707WE3	314	LL49113	352	LL49413	352	LL581B1N	431
LL14706LEN	308	LL14707WEN	314	LL4911N	352	LL4941N	352	LL581B23	431
LL14706LL2	308	LL14707WL2	314	LL491E2	352	LL494E2	352	LL581B2N	431
LL14706LL3	308	LL14707WL3	314	LL491E3	352	LL494E3	352	LL581BG3	431
LL14706LLN	308	LL14707WLN	314	LL491EN	352	LL494EN	352	LL581BGN	431
LL14706LM2	308	LL14707WM2	314	LL491G2	352	LL494G2	352	LL581Q13	431
LL14706LM3	308	LL14707WM3	314	LL491G3	352	LL494G3	352	LL581Q1N	431
LL14706LMN	308	LL14707WMN	314	LL491GN	352	LL494GN	352	LL581Q23	431
LL14706LS2	308	LL14707WS2	314	LL491K2	352	LL494K2	352	LL581Q2N	431
LL14706LS3	308	LL14707WS3	314	LL491K3	352	LL494K3	352	LL581QG3	431
LL14706LSN	308	LL14707WSN	314	LL491KN	352	LL494KN	352	LL581QGN	431
LL14706WE2	308	LL4900002	352	LL49212	352	LL49512	352	LL582B13	431
LL14706WE3	308	LL4900003	352	LL49213	352	LL49513	352	LL582B1N	431
LL14706WEN	308	LL490000N	352	LL4921N	352	LL4951N	352	LL582B23	431
LL14706WL2	308	LL4900012	352	LL492E2	352	LL495E2	352	LL582B2N	431
LL14706WL3	308	LL4900013	352	LL492E3	352	LL495E3	352	LL582BG3	431
LL14706WLN	308	LL490001N	352	LL492EN	352	LL495EN	352	LL582BGN	431
LL14706WM2	308	LL4900022	352	LL492G2	352	LL495G2	352	LL582Q13	431
LL14706WM3	308	LL4900023	352	LL492G3	352	LL495G3	352	LL582Q1N	431
LL14706WMN	308	LL490002N	352	LL492GN	352	LL495GN	352	LL582Q23	431
LL14706WS2	308	LL4900032	352	LL492K2	352	LL495K2	352	LL582Q2N	431
LL14706WS3	308	LL4900033	352	LL492K3	352	LL495K3	352	LL582QG3	431
LL14706WSN	308	LL490003N	352	LL492KN	352	LL495KN	352	LL582QGN	431
LL14707DE2	314	LL4900042	352	LL4931L2	352	LL4961L2	352	LL591B13	432
LL14707DE3	314	LL4900043	352	LL4931L3	352	LL4961L3	352	LL591B1N	432
LL14707DEN	314	LL490004N	352	LL4931LN	352	LL4961LN	352	LL591B23	432
LL14707DL2	314	LL4900052	352	LL4931M2	352	LL4961M2	352	LL591B2N	432
LL14707DL3	314	LL4900053	352	LL4931M3	352	LL4961M3	352	LL591BG3	432
LL14707DLN	314	LL490005N	352	LL4931MN	352	LL4961MN	352	LL591BGN	432
LL14707DM2	314	LL4900062	352	LL4931S2	352	LL4961S2	352	LL591P13	432
LL14707DM3	314	LL4900063	352	LL4931S3	352	LL4961S3	352	LL591P1N	432
LL14707DMN	314	LL490006N	352	LL4931SN	352	LL4961SN	352	LL591P23	432
LL14707DS2	314	LL4900072	352	LL493EL2	352	LL496EL2	352	LL591P2N	432
LL14707DS3	314	LL4900073	352	LL493EL3	352	LL496EL3	352	LL591PG3	432
LL14707DSN	314	LL490007N	352	LL493ELN	352	LL496ELN	352	LL591PGN	432
LL14707KE2	314	LL4900082	352	LL493EM2	352	LL496EM2	352	LL592P13	432



Codice Code Réf.	Pag. Page	Codice Code Réf.	Pag. Page	Codice Code Réf.	Pag. Page	Codice Code Réf.	Pag. Page	Codice Code Réf.	Pag. Page
LL592P1N	432	LL661005N	410	LL697CSN	403	LM134003N	54	LM14000GWN	114
LL592P23	432	LL6610063	410	LL697H3	403	LM1340042	55	LM14000KA2	114
LL592P2N	432	LL661006N	410	LL697HN	403	LM1340043	55	LM14000KA3	114
LL592PG3	432	LL6610073	410	LL707CL3	404	LM134004N	55	LM14000KAN	114
LL592PGN	432	LL661007N	410	LL707CLN	404	LM1340052	55	LM14000KD2	114
LL641C2	390	LL6610083	410	LL707CM3	404	LM1340053	55	LM14000KD3	114
LL641C22	390	LL661008N	410	LL707CMN	404	LM134005N	55	LM14000KDN	114
LL641C23	390	LL6610093	410	LL707CS3	404	LM1340062	55	LM14000KS2	114
LL641C2N	390	LL661009N	410	LL707CSN	404	LM1340063	55	LM14000KS3	114
LL641C3	390	LL6610103	410	LL707H3	404	LM134006N	55	LM14000KSN	114
LL641CG2	390	LL661010N	410	LL707HN	404	LM1340072	55	LM14000KW2	114
LL641CG3	390	LL6610113	410	LL781E23	419	LM1340073	55	LM14000KW3	114
LL641CGN	390	LL661011N	410	LL781E2N	419	LM134007N	55	LM14000KWN	114
LL641CK2	390	LL6610123	410	LL781EG3	419	LM1340122	54	LM14000WA2	114
LL641CK3	390	LL661012N	410	LL781EGN	419	LM1340123	54	LM14000WA3	114
LL641CKN	390	LL661D2	390	LL781EK3	419	LM134012N	54	LM14000WAN	114
LL641CN	390	LL661D22	390	LL781EKN	419	LM1340132	54	LM14000WD2	114
LL641D3	390	LL661D23	390	LL785E3	407	LM1340133	54	LM14000WD3	114
LL641DN	390	LL661D2N	390	LL785EN	407	LM134013N	54	LM14000WDN	114
LL642C3	396	LL661D3	390	LL791G23	419	LM1340142	54	LM14000WS2	114
LL642C8543	413	LL661DG2	390	LL791G2N	419	LM1340143	54	LM14000WS3	114
LL642C854N	413	LL661DG3	390	LL791GG3	419	LM134014N	54	LM14000WSN	114
LL642CN	396	LL661DGN	390	LL791GGN	419	LM1340152	54	LM14000WW2	114
LL642D3	396	LL661DK2	390	LL791GK3	419	LM1340153	54	LM14000WW3	114
LL642DN	396	LL661DK3	390	LL791GKN	419	LM134015N	54	LM14000WWN	114
LL643C2	391	LL661DKN	390	LL802P13	430	LM1340162	56	LM14001EA2	116
LL643C22	391	LL661DN	390	LL802P1N	430	LM1340163	56	LM14001EA3	116
LL643C23	391	LL66233	396	LL802P23	430	LM134016N	56	LM14001EAN	116
LL643C2N	391	LL6623N	396	LL802P2N	430	LM1340172	56	LM14001ED2	116
LL643C3	391	LL662D3	396	LL802PG3	430	LM1340173	56	LM14001ED3	116
LL643CG2	391	LL662DN	396	LL802PGN	430	LM134017N	56	LM14001EDN	116
LL643CG3	391	LL663C3	391	LL802R13	430	LM1340182	56	LM14001ES2	116
LL643CGN	391	LL663CN	391	LL802R1N	430	LM1340183	56	LM14001ES3	116
LL643CK2	391	LL663D3	396	LL802R23	430	LM134018N	56	LM14001ESN	116
LL643CK3	391	LL663DN	396	LL802R2N	430	LM1340192	56	LM14001EW2	116
LL643CKN	391	LL664C3	397	LL802RG3	430	LM1340193	56	LM14001EW3	116
LL643CN	391	LL664CN	397	LL802RGN	430	LM134019N	56	LM14001EWN	116
LL643D3	396	LL665F2	391	LL812D13	430	LM14000EA2	114	LM14001GA2	116
LL643DN	396	LL665F22	391	LL812D1N	430	LM14000EA3	114	LM14001GA3	116
LL644C3	397	LL665F23	391	LL812D23	430	LM14000EAN	114	LM14001GAN	116
LL644C8543	413	LL665F2N	391	LL812D2N	430	LM14000ED2	114	LM14001GD2	116
LL644C854N	413	LL665F3	391	LL812DG3	430	LM14000ED3	114	LM14001GD3	116
LL644CN	397	LL665FG2	391	LL812DGN	430	LM14000EDN	114	LM14001GDN	116
LL651D3	390	LL665FG3	391	LL812R13	430	LM14000ES2	114	LM14001GS2	116
LL651DN	390	LL665FGN	391	LL812R1N	430	LM14000ES3	114	LM14001GS3	116
LL65233	396	LL665FK2	391	LL812R23	430	LM14000ESN	114	LM14001GSN	116
LL6523N	396	LL665FK3	391	LL812R2N	430	LM14000EW2	114	LM14001GW2	116
LL652D3	396	LL665FKN	391	LL812RG3	430	LM14000EW3	114	LM14001GW3	116
LL652DN	396	LL665FN	391	LL812RGN	430	LM14000EWN	114	LM14001GWN	116
LL653D3	396	LL666F3	397	LM1340002	54	LM14000GA2	114	LM14001KA2	116
LL653DN	396	LL666FN	397	LM1340003	54	LM14000GA3	114	LM14001KA3	116
LL6610013	410	LL677H3	403	LM134000N	54	LM14000GAN	114	LM14001KAN	116
LL661001N	410	LL677HN	403	LM1340012	54	LM14000GD2	114	LM14001KD2	116
LL6610023	410	LL687H3	404	LM1340013	54	LM14000GD3	114	LM14001KD3	116
LL661002N	410	LL687HN	404	LM134001N	54	LM14000GDN	114	LM14001KDN	116
LL6610033	410	LL697CL3	403	LM1340022	54	LM14000GS2	114	LM14001KS2	116
LL661003N	410	LL697CLN	403	LM1340023	54	LM14000GS3	114	LM14001KS3	116
LL6610043	410	LL697CM3	403	LM134002N	54	LM14000GSN	114	LM14001KSN	116
LL661004N	410	LL697CMN	403	LM1340032	54	LM14000GW2	114	LM14001KW2	116
LL6610053	410	LL697CS3	403	LM1340033	54	LM14000GW3	114	LM14001KW3	116

# RICERCA ALFANUMERICA PER CODICE

Codice Code Réf.	Pag. Page	Codice Code Réf.	Pag. Page	Codice Code Réf.	Pag. Page	Codice Code Réf.	Pag. Page	Codice Code Réf.	Pag. Page
LM14001KWN	116	LM14010WVN	115	LM14021EWN	117	LM14030GWN	114	LM14031KWN	116
LM14001WA2	116	LM14011EA2	117	LM14021GA2	117	LM14030KA2	114	LM14031WA2	116
LM14001WA3	116	LM14011EA3	117	LM14021GA3	117	LM14030KA3	114	LM14031WA3	116
LM14001WAN	116	LM14011EAN	117	LM14021GAN	117	LM14030KAN	114	LM14031WAN	116
LM14001WD2	116	LM14011ED2	117	LM14021GD2	117	LM14030KD2	114	LM14031WD2	116
LM14001WD3	116	LM14011ED3	117	LM14021GD3	117	LM14030KD3	114	LM14031WD3	116
LM14001WDN	116	LM14011EDN	117	LM14021GDN	117	LM14030KDN	114	LM14031WDN	116
LM14001WS2	116	LM14011ES2	117	LM14021GS2	117	LM14030KS2	114	LM14031WS2	116
LM14001WS3	116	LM14011ES3	117	LM14021GS3	117	LM14030KS3	114	LM14031WS3	116
LM14001WSN	116	LM14011ESN	117	LM14021GSN	117	LM14030KSN	114	LM14031WSN	116
LM14001WW2	116	LM14011EW2	117	LM14021GW2	117	LM14030KW2	114	LM14031WW2	116
LM14001WW3	116	LM14011EW3	117	LM14021GW3	117	LM14030KW3	114	LM14031WW3	116
LM14001WVN	116	LM14011EWN	117	LM14021GWN	117	LM14030KWN	114	LM14031WVN	116
LM14010EA2	115	LM14011GA2	117	LM14021KA2	117	LM14030WA2	114	LN1160012	35
LM14010EA3	115	LM14011GA3	117	LM14021KA3	117	LM14030WA3	114	LN1160013	35
LM14010EAN	115	LM14011GAN	117	LM14021KAN	117	LM14030WAN	114	LN116001N	35
LM14010ED2	115	LM14011GD2	117	LM14021KD2	117	LM14030WD2	114	LN1160022	35
LM14010ED3	115	LM14011GD3	117	LM14021KD3	117	LM14030WD3	114	LN1160023	35
LM14010EDN	115	LM14011GDN	117	LM14021KDN	117	LM14030WDN	114	LN116002N	35
LM14010ES2	115	LM14011GS2	117	LM14021KS2	117	LM14030WS2	114	LN1160032	35
LM14010ES3	115	LM14011GS3	117	LM14021KS3	117	LM14030WS3	114	LN1160033	35
LM14010ESN	115	LM14011GSN	117	LM14021KSN	117	LM14030WSN	114	LN116003N	35
LM14010EW2	115	LM14011GW2	117	LM14021KW2	117	LM14030WW2	114	LN1160042	35
LM14010EW3	115	LM14011GW3	117	LM14021KW3	117	LM14030WW3	114	LN1160043	35
LM14010EWN	115	LM14011GWN	117	LM14021KWN	117	LM14030WVN	114	LN116004N	35
LM14010GA2	115	LM14011KA2	117	LM14021WA2	117	LM14031EA2	116	LN1160052	35
LM14010GA3	115	LM14011KA3	117	LM14021WA3	117	LM14031EA3	116	LN1160053	35
LM14010GAN	115	LM14011KAN	117	LM14021WAN	117	LM14031EAN	116	LN116005N	35
LM14010GD2	115	LM14011KD2	117	LM14021WD2	117	LM14031ED2	116	LN1161012	37
LM14010GD3	115	LM14011KD3	117	LM14021WD3	117	LM14031ED3	116	LN1161013	37
LM14010GDN	115	LM14011KDN	117	LM14021WDN	117	LM14031EDN	116	LN116101N	37
LM14010GS2	115	LM14011KS2	117	LM14021WS2	117	LM14031ES2	116	LN1161022	37
LM14010GS3	115	LM14011KS3	117	LM14021WS3	117	LM14031ES3	116	LN1161023	37
LM14010GSN	115	LM14011KSN	117	LM14021WSN	117	LM14031ESN	116	LN116102N	37
LM14010GW2	115	LM14011KW2	117	LM14021WW2	117	LM14031EW2	116	LN1161032	37
LM14010GW3	115	LM14011KW3	117	LM14021WW3	117	LM14031EW3	116	LN1161033	37
LM14010GWN	115	LM14011KWN	117	LM14021WVN	117	LM14031EWN	116	LN116103N	37
LM14010KA2	115	LM14011WA2	117	LM14030EA2	114	LM14031GA2	116	LN1161042	37
LM14010KA3	115	LM14011WA3	117	LM14030EA3	114	LM14031GA3	116	LN1161043	37
LM14010KAN	115	LM14011WAN	117	LM14030EAN	114	LM14031GAN	116	LN116104N	37
LM14010KD2	115	LM14011WD2	117	LM14030ED2	114	LM14031GD2	116	LN1161052	37
LM14010KD3	115	LM14011WD3	117	LM14030ED3	114	LM14031GD3	116	LN1161053	37
LM14010KDN	115	LM14011WDN	117	LM14030EDN	114	LM14031GDN	116	LN116105N	37
LM14010KS2	115	LM14011WS2	117	LM14030ES2	114	LM14031GS2	116	LS1160012	34
LM14010KS3	115	LM14011WS3	117	LM14030ES3	114	LM14031GS3	116	LS1160013	34
LM14010KSN	115	LM14011WSN	117	LM14030ESN	114	LM14031GSN	116	LS116001N	34
LM14010KW2	115	LM14011WW2	117	LM14030EW2	114	LM14031GW2	116	LS1160022	34
LM14010KW3	115	LM14011WW3	117	LM14030EW3	114	LM14031GW3	116	LS1160023	34
LM14010KWN	115	LM14011WVN	117	LM14030EWN	114	LM14031GWN	116	LS116002N	34
LM14010WA2	115	LM14021EA2	117	LM14030GA2	114	LM14031KA2	116	LS1160032	34
LM14010WA3	115	LM14021EA3	117	LM14030GA3	114	LM14031KA3	116	LS1160033	34
LM14010WAN	115	LM14021EAN	117	LM14030GAN	114	LM14031KAN	116	LS116003N	34
LM14010WD2	115	LM14021ED2	117	LM14030GD2	114	LM14031KD2	116	LS1160042	34
LM14010WD3	115	LM14021ED3	117	LM14030GD3	114	LM14031KD3	116	LS1160043	34
LM14010WDN	115	LM14021EDN	117	LM14030GDN	114	LM14031KDN	116	LS116004N	34
LM14010WS2	115	LM14021ES2	117	LM14030GS2	114	LM14031KS2	116	LS1160052	34
LM14010WS3	115	LM14021ES3	117	LM14030GS3	114	LM14031KS3	116	LS1160053	34
LM14010WSN	115	LM14021ESN	117	LM14030GSN	114	LM14031KSN	116	LS116005N	34
LM14010WW2	115	LM14021EW2	117	LM14030GW2	114	LM14031KW2	116	LS1161012	36
LM14010WW3	115	LM14021EW3	117	LM14030GW3	114	LM14031KW3	116	LS1161013	36





Codice Code Réf.	Pag. Page	Codice Code Réf.	Pag. Page	Codice Code Réf.	Pag. Page	Codice Code Réf.	Pag. Page	Codice Code Réf.	Pag. Page
LS116101N	36	LT126001SN	192	LT126006SN	192	LT126103SN	192	LT126303N	211
LS1161022	36	LT126002D2	192	LT126007D2	192	LT126104D2	193	LT1263042	211
LS1161023	36	LT126002D3	192	LT126007D3	192	LT126104D3	193	LT1263043	211
LS116102N	36	LT126002DN	192	LT126007DN	192	LT126104DN	193	LT126304N	211
LS1161032	36	LT126002L2	192	LT126007L2	192	LT126104L2	193	LT1263052	211
LS1161033	36	LT126002L3	192	LT126007L3	192	LT126104L3	193	LT1263053	211
LS116103N	36	LT126002LN	192	LT126007LN	192	LT126104LN	193	LT126305N	211
LS1161042	36	LT126002M2	192	LT126007M2	192	LT126104M2	193	LT1263092	211
LS1161043	36	LT126002M3	192	LT126007M3	192	LT126104M3	193	LT1263093	211
LS116104N	36	LT126002MN	192	LT126007MN	192	LT126104MN	193	LT126309N	211
LS1161052	36	LT126002S2	192	LT126007S2	192	LT126104S2	193	LT1263102	211
LS1161053	36	LT126002S3	192	LT126007S3	192	LT126104S3	193	LT1263103	211
LS116105N	36	LT126002SN	192	LT126007SN	192	LT126104SN	193	LT126310N	211
LS581013	431	LT126003D2	192	LT126100D2	192	LT126105D2	193	LT1263112	211
LS58101N	431	LT126003D3	192	LT126100D3	192	LT126105D3	193	LT1263113	211
LS581023	431	LT126003DN	192	LT126100DN	192	LT126105DN	193	LT126311N	211
LS58102N	431	LT126003L2	192	LT126100L2	192	LT126105L2	193	LT1263122	211
LS5810G3	431	LT126003L3	192	LT126100L3	192	LT126105L3	193	LT1263123	211
LS5810GN	431	LT126003LN	192	LT126100LN	192	LT126105LN	193	LT126312N	211
LS591P13	432	LT126003M2	192	LT126100M2	192	LT126105M2	193	LT1263132	211
LS591P1N	432	LT126003M3	192	LT126100M3	192	LT126105M3	193	LT1263133	211
LS591P23	432	LT126003MN	192	LT126100MN	192	LT126105MN	193	LT126313N	211
LS591P2N	432	LT126003S2	192	LT126100S2	192	LT126105S2	193	LT1263142	211
LS591PG3	432	LT126003S3	192	LT126100S3	192	LT126105S3	193	LT1263143	211
LS591PGN	432	LT126003SN	192	LT126100SN	192	LT126105SN	193	LT126314N	211
LS802P13	430	LT126004D2	192	LT126101D2	192	LT126106D2	193	LT1263182	210
LS802P1N	430	LT126004D3	192	LT126101D3	192	LT126106D3	193	LT1263183	210
LS802P23	430	LT126004DN	192	LT126101DN	192	LT126106DN	193	LT126318N	210
LS802P2N	430	LT126004L2	192	LT126101L2	192	LT126106L2	193	LT1263192	210
LS802PG3	430	LT126004L3	192	LT126101L3	192	LT126106L3	193	LT1263193	210
LS802PGN	430	LT126004LN	192	LT126101LN	192	LT126106LN	193	LT126319N	210
LS812D13	430	LT126004M2	192	LT126101M2	192	LT126106M2	193	LT1263202	210
LS812D1N	430	LT126004M3	192	LT126101M3	192	LT126106M3	193	LT1263203	210
LS812D23	430	LT126004MN	192	LT126101MN	192	LT126106MN	193	LT126320N	210
LS812D2N	430	LT126004S2	192	LT126101S2	192	LT126106S2	193	LT1263212	210
LS812DG3	430	LT126004S3	192	LT126101S3	192	LT126106S3	193	LT1263213	210
LS812DGN	430	LT126004SN	192	LT126101SN	192	LT126106SN	193	LT126321N	210
LT126000D2	192	LT126005D2	192	LT126102D2	192	LT126107D2	193	LT1263222	210
LT126000D3	192	LT126005D3	192	LT126102D3	192	LT126107D3	193	LT1263223	210
LT126000DN	192	LT126005DN	192	LT126102DN	192	LT126107DN	193	LT126322N	210
LT126000L2	192	LT126005L2	192	LT126102L2	192	LT126107L2	193	LT1263232	210
LT126000L3	192	LT126005L3	192	LT126102L3	192	LT126107L3	193	LT1263233	210
LT126000LN	192	LT126005LN	192	LT126102LN	192	LT126107LN	193	LT126323N	210
LT126000M2	192	LT126005M2	192	LT126102M2	192	LT126107M2	193	LT1350002	82
LT126000M3	192	LT126005M3	192	LT126102M3	192	LT126107M3	193	LT1350003	82
LT126000MN	192	LT126005MN	192	LT126102MN	192	LT126107MN	193	LT135000N	82
LT126000S2	192	LT126005S2	192	LT126102S2	192	LT126107S2	193	LT1350012	82
LT126000S3	192	LT126005S3	192	LT126102S3	192	LT126107S3	193	LT1350013	82
LT126000SN	192	LT126005SN	192	LT126102SN	192	LT126107SN	193	LT135001N	82
LT126001D2	192	LT126006D2	192	LT126103D2	192	LT1263002	210	LT1350022	82
LT126001D3	192	LT126006D3	192	LT126103D3	192	LT1263003	210	LT1350023	82
LT126001DN	192	LT126006DN	192	LT126103DN	192	LT126300N	210	LT135002N	82
LT126001L2	192	LT126006L2	192	LT126103L2	192	LT1263012	210	LT1350032	82
LT126001L3	192	LT126006L3	192	LT126103L3	192	LT1263013	210	LT1350033	82
LT126001LN	192	LT126006LN	192	LT126103LN	192	LT126301N	210	LT135003N	82
LT126001M2	192	LT126006M2	192	LT126103M2	192	LT1263022	210	LT1350042	82
LT126001M3	192	LT126006M3	192	LT126103M3	192	LT1263023	210	LT1350043	82
LT126001MN	192	LT126006MN	192	LT126103MN	192	LT126302N	210	LT135004N	82
LT126001S2	192	LT126006S2	192	LT126103S2	192	LT1263032	211	LT1350052	82
LT126001S3	192	LT126006S3	192	LT126103S3	192	LT1263033	211	LT1350053	82

# RICERCA ALFANUMERICA PER CODICE

Codice Code Réf.	Pag. Page	Codice Code Réf.	Pag. Page	Codice Code Réf.	Pag. Page	Codice Code Réf.	Pag. Page	Codice Code Réf.	Pag. Page
LT135005N	82	LT14000KDN	114	LT14001WDN	116	LT14011EDN	117	LT14021GDN	117
LT1350062	82	LT14000KS2	114	LT14001WS2	116	LT14011ES2	117	LT14021GS2	117
LT1350063	82	LT14000KS3	114	LT14001WS3	116	LT14011ES3	117	LT14021GS3	117
LT135006N	82	LT14000KSN	114	LT14001WSN	116	LT14011ESN	117	LT14021GSN	117
LT1350072	82	LT14000KW2	114	LT14001WW2	116	LT14011EW2	117	LT14021GW2	117
LT1350073	82	LT14000KW3	114	LT14001WW3	116	LT14011EW3	117	LT14021GW3	117
LT135007N	82	LT14000KWN	114	LT14001WWN	116	LT14011EWN	117	LT14021GWN	117
LT1351002	82	LT14000WA2	114	LT14010EA2	115	LT14011GA2	117	LT14021KA2	117
LT1351003	82	LT14000WA3	114	LT14010EA3	115	LT14011GA3	117	LT14021KA3	117
LT135100N	82	LT14000WAN	114	LT14010EAN	115	LT14011GAN	117	LT14021KAN	117
LT1351012	82	LT14000WD2	114	LT14010ED2	115	LT14011GD2	117	LT14021KD2	117
LT1351013	82	LT14000WD3	114	LT14010ED3	115	LT14011GD3	117	LT14021KD3	117
LT135101N	82	LT14000WDN	114	LT14010EDN	115	LT14011GDN	117	LT14021KDN	117
LT1351022	82	LT14000WS2	114	LT14010ES2	115	LT14011GS2	117	LT14021KS2	117
LT1351023	82	LT14000WS3	114	LT14010ES3	115	LT14011GS3	117	LT14021KS3	117
LT135102N	82	LT14000WSN	114	LT14010ESN	115	LT14011GSN	117	LT14021KSN	117
LT1351032	82	LT14000WW2	114	LT14010EW2	115	LT14011GW2	117	LT14021KW2	117
LT1351033	82	LT14000WW3	114	LT14010EW3	115	LT14011GW3	117	LT14021KW3	117
LT135103N	82	LT14000WWN	114	LT14010EWN	115	LT14011GWN	117	LT14021KWN	117
LT1351042	83	LT14001EA2	116	LT14010GA2	115	LT14011KA2	117	LT14021WA2	117
LT1351043	83	LT14001EA3	116	LT14010GA3	115	LT14011KA3	117	LT14021WA3	117
LT135104N	83	LT14001EAN	116	LT14010GAN	115	LT14011KAN	117	LT14021WAN	117
LT1351052	83	LT14001ED2	116	LT14010GD2	115	LT14011KD2	117	LT14021WD2	117
LT1351053	83	LT14001ED3	116	LT14010GD3	115	LT14011KD3	117	LT14021WD3	117
LT135105N	83	LT14001EDN	116	LT14010GDN	115	LT14011KDN	117	LT14021WDN	117
LT1351062	83	LT14001ES2	116	LT14010GS2	115	LT14011KS2	117	LT14021WS2	117
LT1351063	83	LT14001ES3	116	LT14010GS3	115	LT14011KS3	117	LT14021WS3	117
LT135106N	83	LT14001ESN	116	LT14010GSN	115	LT14011KSN	117	LT14021WSN	117
LT1351072	83	LT14001EW2	116	LT14010GW2	115	LT14011KW2	117	LT14021WW2	117
LT1351073	83	LT14001EW3	116	LT14010GW3	115	LT14011KW3	117	LT14021WW3	117
LT135107N	83	LT14001EWN	116	LT14010GWN	115	LT14011KWN	117	LT14021WWN	117
LT14000EA2	114	LT14001GA2	116	LT14010KA2	115	LT14011WA2	117	LT14030EA2	114
LT14000EA3	114	LT14001GA3	116	LT14010KA3	115	LT14011WA3	117	LT14030EA3	114
LT14000EAN	114	LT14001GAN	116	LT14010KAN	115	LT14011WAN	117	LT14030EAN	114
LT14000ED2	114	LT14001GD2	116	LT14010KD2	115	LT14011WD2	117	LT14030ED2	114
LT14000ED3	114	LT14001GD3	116	LT14010KD3	115	LT14011WD3	117	LT14030ED3	114
LT14000EDN	114	LT14001GDN	116	LT14010KDN	115	LT14011WDN	117	LT14030EDN	114
LT14000ES2	114	LT14001GS2	116	LT14010KS2	115	LT14011WS2	117	LT14030ES2	114
LT14000ES3	114	LT14001GS3	116	LT14010KS3	115	LT14011WS3	117	LT14030ES3	114
LT14000ESN	114	LT14001GSN	116	LT14010KSN	115	LT14011WSN	117	LT14030ESN	114
LT14000EW2	114	LT14001GW2	116	LT14010KW2	115	LT14011WW2	117	LT14030EW2	114
LT14000EW3	114	LT14001GW3	116	LT14010KW3	115	LT14011WW3	117	LT14030EW3	114
LT14000EWN	114	LT14001GWN	116	LT14010KWN	115	LT14011WWN	117	LT14030EWN	114
LT14000GA2	114	LT14001KA2	116	LT14010WA2	115	LT14021EA2	117	LT14030GA2	114
LT14000GA3	114	LT14001KA3	116	LT14010WA3	115	LT14021EA3	117	LT14030GA3	114
LT14000GAN	114	LT14001KAN	116	LT14010WAN	115	LT14021EAN	117	LT14030GAN	114
LT14000GD2	114	LT14001KD2	116	LT14010WD2	115	LT14021ED2	117	LT14030GD2	114
LT14000GD3	114	LT14001KD3	116	LT14010WD3	115	LT14021ED3	117	LT14030GD3	114
LT14000GDN	114	LT14001KDN	116	LT14010WDN	115	LT14021EDN	117	LT14030GDN	114
LT14000GS2	114	LT14001KS2	116	LT14010WS2	115	LT14021ES2	117	LT14030GS2	114
LT14000GS3	114	LT14001KS3	116	LT14010WS3	115	LT14021ES3	117	LT14030GS3	114
LT14000GSN	114	LT14001KSN	116	LT14010WSN	115	LT14021ESN	117	LT14030GSN	114
LT14000GW2	114	LT14001KW2	116	LT14010WW2	115	LT14021EW2	117	LT14030GW2	114
LT14000GW3	114	LT14001KW3	116	LT14010WW3	115	LT14021EW3	117	LT14030GW3	114
LT14000GWN	114	LT14001KWN	116	LT14010WWN	115	LT14021EWN	117	LT14030GWN	114
LT14000KA2	114	LT14001WA2	116	LT14011EA2	117	LT14021GA2	117	LT14030KA2	114
LT14000KA3	114	LT14001WA3	116	LT14011EA3	117	LT14021GA3	117	LT14030KA3	114
LT14000KAN	114	LT14001WAN	116	LT14011EAN	117	LT14021GAN	117	LT14030KAN	114
LT14000KD2	114	LT14001WD2	116	LT14011ED2	117	LT14021GD2	117	LT14030KD2	114
LT14000KD3	114	LT14001WD3	116	LT14011ED3	117	LT14021GD3	117	LT14030KD3	114



Codice Code Réf.	Pag. Page	Codice Code Réf.	Pag. Page	Codice Code Réf.	Pag. Page	Codice Code Réf.	Pag. Page	Codice Code Réf.	Pag. Page
LT14030KDN	114	LT14031WDN	116	LZ14600ZSN	284	LZ14602AMN	285	LZ14603BDN	286
LT14030KS2	114	LT14031WS2	116	LZ14601AD2	284	LZ14602AS2	285	LZ14603BM2	286
LT14030KS3	114	LT14031WS3	116	LZ14601AD3	284	LZ14602AS3	285	LZ14603BM3	286
LT14030KSN	114	LT14031WSN	116	LZ14601ADN	284	LZ14602ASN	285	LZ14603BMN	286
LT14030KW2	114	LT14031WW2	116	LZ14601AM2	284	LZ14602BD2	285	LZ14603BS2	286
LT14030KW3	114	LT14031WW3	116	LZ14601AM3	284	LZ14602BD3	285	LZ14603BS3	286
LT14030KWN	114	LT14031WWN	116	LZ14601AMN	284	LZ14602BDN	285	LZ14603BSN	286
LT14030WA2	114	LZ14600AD2	284	LZ14601AS2	284	LZ14602BM2	285	LZ14603GD2	286
LT14030WA3	114	LZ14600AD3	284	LZ14601AS3	284	LZ14602BM3	285	LZ14603GD3	286
LT14030WAN	114	LZ14600ADN	284	LZ14601ASN	284	LZ14602BMN	285	LZ14603GDN	286
LT14030WD2	114	LZ14600AM2	284	LZ14601BD2	284	LZ14602BS2	285	LZ14603GM2	286
LT14030WD3	114	LZ14600AM3	284	LZ14601BD3	284	LZ14602BS3	285	LZ14603GM3	286
LT14030WDN	114	LZ14600AMN	284	LZ14601BDN	284	LZ14602BSN	285	LZ14603GMN	286
LT14030WS2	114	LZ14600AS2	284	LZ14601BM2	284	LZ14602GD2	285	LZ14603GS2	286
LT14030WS3	114	LZ14600AS3	284	LZ14601BM3	284	LZ14602GD3	285	LZ14603GS3	286
LT14030WSN	114	LZ14600ASN	284	LZ14601BMN	284	LZ14602GDN	285	LZ14603GSN	286
LT14030WW2	114	LZ14600BD2	284	LZ14601BS2	284	LZ14602GM2	285	LZ14603UD2	286
LT14030WW3	114	LZ14600BD3	284	LZ14601BS3	284	LZ14602GM3	285	LZ14603UD3	286
LT14030WWN	114	LZ14600BDN	284	LZ14601BSN	284	LZ14602GMN	285	LZ14603UDN	286
LT14031EA2	116	LZ14600BM2	284	LZ14601GD2	284	LZ14602GS2	285	LZ14603UM2	286
LT14031EA3	116	LZ14600BM3	284	LZ14601GD3	284	LZ14602GS3	285	LZ14603UM3	286
LT14031EAN	116	LZ14600BMN	284	LZ14601GDN	284	LZ14602GSN	285	LZ14603UMN	286
LT14031ED2	116	LZ14600BS2	284	LZ14601GM2	284	LZ14602UD2	285	LZ14603US2	286
LT14031ED3	116	LZ14600BS3	284	LZ14601GM3	284	LZ14602UD3	285	LZ14603US3	286
LT14031EDN	116	LZ14600BSN	284	LZ14601GMN	284	LZ14602UDN	285	LZ14603USN	286
LT14031ES2	116	LZ14600GD2	284	LZ14601GS2	284	LZ14602UM2	285	LZ14603WD2	286
LT14031ES3	116	LZ14600GD3	284	LZ14601GS3	284	LZ14602UM3	285	LZ14603WD3	286
LT14031ESN	116	LZ14600GDN	284	LZ14601GSN	284	LZ14602UMN	285	LZ14603WDN	286
LT14031EW2	116	LZ14600GM2	284	LZ14601UD2	284	LZ14602US2	285	LZ14603WM2	286
LT14031EW3	116	LZ14600GM3	284	LZ14601UD3	284	LZ14602US3	285	LZ14603WM3	286
LT14031EWN	116	LZ14600GMN	284	LZ14601UDN	284	LZ14602USN	285	LZ14603WMN	286
LT14031GA2	116	LZ14600GS2	284	LZ14601UM2	284	LZ14602WD2	285	LZ14603WS2	286
LT14031GA3	116	LZ14600GS3	284	LZ14601UM3	284	LZ14602WD3	285	LZ14603WS3	286
LT14031GAN	116	LZ14600GSN	284	LZ14601UMN	284	LZ14602WDN	285	LZ14603WSN	286
LT14031GD2	116	LZ14600UD2	284	LZ14601US2	284	LZ14602WM2	285	LZ14603ZD2	286
LT14031GD3	116	LZ14600UD3	284	LZ14601US3	284	LZ14602WM3	285	LZ14603ZD3	286
LT14031GDN	116	LZ14600UDN	284	LZ14601USN	284	LZ14602WMN	285	LZ14603ZDN	286
LT14031GS2	116	LZ14600UM2	284	LZ14601WD2	284	LZ14602WS2	285	LZ14603ZM2	286
LT14031GS3	116	LZ14600UM3	284	LZ14601WD3	284	LZ14602WS3	285	LZ14603ZM3	286
LT14031GSN	116	LZ14600UMN	284	LZ14601WDN	284	LZ14602WSN	285	LZ14603ZMN	286
LT14031GW2	116	LZ14600US2	284	LZ14601WM2	284	LZ14602ZD2	285	LZ14603ZS2	286
LT14031GW3	116	LZ14600US3	284	LZ14601WM3	284	LZ14602ZD3	285	LZ14603ZS3	286
LT14031GWN	116	LZ14600USN	284	LZ14601WMN	284	LZ14602ZDN	285	LZ14603ZSN	286
LT14031KA2	116	LZ14600WD2	284	LZ14601WS2	284	LZ14602ZM2	285	LZ14604AD2	285
LT14031KA3	116	LZ14600WD3	284	LZ14601WS3	284	LZ14602ZM3	285	LZ14604AD3	285
LT14031KAN	116	LZ14600WDN	284	LZ14601WSN	284	LZ14602ZMN	285	LZ14604ADN	285
LT14031KD2	116	LZ14600WM2	284	LZ14601ZD2	284	LZ14602ZS2	285	LZ14604AM2	285
LT14031KD3	116	LZ14600WM3	284	LZ14601ZD3	284	LZ14602ZS3	285	LZ14604AM3	285
LT14031KDN	116	LZ14600WMN	284	LZ14601ZDN	284	LZ14602ZSN	285	LZ14604AMN	285
LT14031KS2	116	LZ14600WS2	284	LZ14601ZM2	284	LZ14603AD2	286	LZ14604AS2	285
LT14031KS3	116	LZ14600WS3	284	LZ14601ZM3	284	LZ14603AD3	286	LZ14604AS3	285
LT14031KSN	116	LZ14600WSN	284	LZ14601ZMN	284	LZ14603ADN	286	LZ14604ASN	285
LT14031KW2	116	LZ14600ZD2	284	LZ14601ZS2	284	LZ14603AM2	286	LZ14604BD2	285
LT14031KW3	116	LZ14600ZD3	284	LZ14601ZS3	284	LZ14603AM3	286	LZ14604BD3	285
LT14031KWN	116	LZ14600ZDN	284	LZ14601ZSN	284	LZ14603AMN	286	LZ14604BDN	285
LT14031WA2	116	LZ14600ZM2	284	LZ14602AD2	285	LZ14603AS2	286	LZ14604BM2	285
LT14031WA3	116	LZ14600ZM3	284	LZ14602AD3	285	LZ14603AS3	286	LZ14604BM3	285
LT14031WAN	116	LZ14600ZMN	284	LZ14602ADN	285	LZ14603ASN	286	LZ14604BMN	285
LT14031WD2	116	LZ14600ZS2	284	LZ14602AM2	285	LZ14603BD2	286	LZ14604BS2	285
LT14031WD3	116	LZ14600ZS3	284	LZ14602AM3	285	LZ14603BD3	286	LZ14604BS3	285

# RICERCA ALFANUMERICA PER CODICE

Codice Code Réf.	Pag. Page	Codice Code Réf.	Pag. Page	Codice Code Réf.	Pag. Page	Codice Code Réf.	Pag. Page	Codice Code Réf.	Pag. Page
LZ14604BSN	285	LZ14605GMN	286	LZ14606UDN	287	LZ14702BSN	302	LZ14704KSN	308
LZ14604GD2	285	LZ14605GS2	286	LZ14606UM2	287	LZ14702WE2	302	LZ14704LE2	308
LZ14604GD3	285	LZ14605GS3	286	LZ14606UM3	287	LZ14702WE3	302	LZ14704LE3	308
LZ14604GDN	285	LZ14605GSN	286	LZ14606UMN	287	LZ14702WEN	302	LZ14704LEN	308
LZ14604GM2	285	LZ14605UD2	286	LZ14606US2	287	LZ14702WL2	302	LZ14704LL2	308
LZ14604GM3	285	LZ14605UD3	286	LZ14606US3	287	LZ14702WL3	302	LZ14704LL3	308
LZ14604GMN	285	LZ14605UDN	286	LZ14606USN	287	LZ14702WLN	302	LZ14704LLN	308
LZ14604GS2	285	LZ14605UM2	286	LZ14606WD2	287	LZ14702WM2	302	LZ14704LM2	308
LZ14604GS3	285	LZ14605UM3	286	LZ14606WD3	287	LZ14702WM3	302	LZ14704LM3	308
LZ14604GSN	285	LZ14605UMN	286	LZ14606WDN	287	LZ14702WMN	302	LZ14704LMN	308
LZ14604UD2	285	LZ14605US2	286	LZ14606WM2	287	LZ14702WS2	302	LZ14704LS2	308
LZ14604UD3	285	LZ14605US3	286	LZ14606WM3	287	LZ14702WS3	302	LZ14704LS3	308
LZ14604UDN	285	LZ14605USN	286	LZ14606WMN	287	LZ14702WSN	302	LZ14704LSN	308
LZ14604UM2	285	LZ14605WD2	286	LZ14606WS2	287	LZ14703BE2	302	LZ14704WE2	308
LZ14604UM3	285	LZ14605WD3	286	LZ14606WS3	287	LZ14703BE3	302	LZ14704WE3	308
LZ14604UMN	285	LZ14605WDN	286	LZ14606WSN	287	LZ14703BEN	302	LZ14704WEN	308
LZ14604US2	285	LZ14605WM2	286	LZ14606ZD2	287	LZ14703BL2	302	LZ14704WL2	308
LZ14604US3	285	LZ14605WM3	286	LZ14606ZD3	287	LZ14703BL3	302	LZ14704WL3	308
LZ14604USN	285	LZ14605WMN	286	LZ14606ZDN	287	LZ14703BLN	302	LZ14704WLN	308
LZ14604WD2	285	LZ14605WS2	286	LZ14606ZM2	287	LZ14703BM2	302	LZ14704WM2	308
LZ14604WD3	285	LZ14605WS3	286	LZ14606ZM3	287	LZ14703BM3	302	LZ14704WM3	308
LZ14604WDN	285	LZ14605WSN	286	LZ14606ZMN	287	LZ14703BMN	302	LZ14704WMN	308
LZ14604WM2	285	LZ14605ZD2	286	LZ14606ZS2	287	LZ14703BS2	302	LZ14704WS2	308
LZ14604WM3	285	LZ14605ZD3	286	LZ14606ZS3	287	LZ14703BS3	302	LZ14704WS3	308
LZ14604WMN	285	LZ14605ZDN	286	LZ14606ZSN	287	LZ14703BSN	302	LZ14704WSN	308
LZ14604WS2	285	LZ14605ZM2	286	LZ14701BE2	302	LZ14703WE2	302	LZ14705DE2	308
LZ14604WS3	285	LZ14605ZM3	286	LZ14701BE3	302	LZ14703WE3	302	LZ14705DE3	308
LZ14604WSN	285	LZ14605ZMN	286	LZ14701BEN	302	LZ14703WEN	302	LZ14705DEN	308
LZ14604ZD2	285	LZ14605ZS2	286	LZ14701BL2	302	LZ14703WL2	302	LZ14705DL2	308
LZ14604ZD3	285	LZ14605ZS3	286	LZ14701BL3	302	LZ14703WL3	302	LZ14705DL3	308
LZ14604ZDN	285	LZ14605ZSN	286	LZ14701BLN	302	LZ14703WLN	302	LZ14705DLN	308
LZ14604ZM2	285	LZ14606AD2	287	LZ14701BM2	302	LZ14703WM2	302	LZ14705DM2	308
LZ14604ZM3	285	LZ14606AD3	287	LZ14701BM3	302	LZ14703WM3	302	LZ14705DM3	308
LZ14604ZMN	285	LZ14606ADN	287	LZ14701BMN	302	LZ14703WMN	302	LZ14705DMN	308
LZ14604ZS2	285	LZ14606AM2	287	LZ14701BS2	302	LZ14703WS2	302	LZ14705DS2	308
LZ14604ZS3	285	LZ14606AM3	287	LZ14701BS3	302	LZ14703WS3	302	LZ14705DS3	308
LZ14604ZSN	285	LZ14606AMN	287	LZ14701BSN	302	LZ14703WSN	302	LZ14705DSN	308
LZ14605AD2	286	LZ14606AS2	287	LZ14701WE2	302	LZ14704DE2	308	LZ14705KE2	308
LZ14605AD3	286	LZ14606AS3	287	LZ14701WE3	302	LZ14704DE3	308	LZ14705KE3	308
LZ14605ADN	286	LZ14606ASN	287	LZ14701WEN	302	LZ14704DEN	308	LZ14705KEN	308
LZ14605AM2	286	LZ14606BD2	287	LZ14701WL2	302	LZ14704DL2	308	LZ14705KL2	308
LZ14605AM3	286	LZ14606BD3	287	LZ14701WL3	302	LZ14704DL3	308	LZ14705KL3	308
LZ14605AMN	286	LZ14606BDN	287	LZ14701WLN	302	LZ14704DLN	308	LZ14705KLN	308
LZ14605AS2	286	LZ14606BM2	287	LZ14701WM2	302	LZ14704DM2	308	LZ14705KM2	308
LZ14605AS3	286	LZ14606BM3	287	LZ14701WM3	302	LZ14704DM3	308	LZ14705KM3	308
LZ14605ASN	286	LZ14606BMN	287	LZ14701WMN	302	LZ14704DMN	308	LZ14705KMN	308
LZ14605BD2	286	LZ14606BS2	287	LZ14701WS2	302	LZ14704DS2	308	LZ14705KS2	308
LZ14605BD3	286	LZ14606BS3	287	LZ14701WS3	302	LZ14704DS3	308	LZ14705KS3	308
LZ14605BDN	286	LZ14606BSN	287	LZ14701WSN	302	LZ14704DSN	308	LZ14705KSN	308
LZ14605BM2	286	LZ14606GD2	287	LZ14702BE2	302	LZ14704KE2	308	LZ14705LE2	308
LZ14605BM3	286	LZ14606GD3	287	LZ14702BE3	302	LZ14704KE3	308	LZ14705LE3	308
LZ14605BMN	286	LZ14606GDN	287	LZ14702BEN	302	LZ14704KEN	308	LZ14705LEN	308
LZ14605BS2	286	LZ14606GM2	287	LZ14702BL2	302	LZ14704KL2	308	LZ14705LL2	308
LZ14605BS3	286	LZ14606GM3	287	LZ14702BL3	302	LZ14704KL3	308	LZ14705LL3	308
LZ14605BSN	286	LZ14606GMN	287	LZ14702BLN	302	LZ14704KLN	308	LZ14705LLN	308
LZ14605GD2	286	LZ14606GS2	287	LZ14702BM2	302	LZ14704KM2	308	LZ14705LM2	308
LZ14605GD3	286	LZ14606GS3	287	LZ14702BM3	302	LZ14704KM3	308	LZ14705LM3	308
LZ14605GDN	286	LZ14606GSN	287	LZ14702BMN	302	LZ14704KMN	308	LZ14705LMN	308
LZ14605GM2	286	LZ14606UD2	287	LZ14702BS2	302	LZ14704KS2	308	LZ14705LS2	308
LZ14605GM3	286	LZ14606UD3	287	LZ14702BS3	302	LZ14704KS3	308	LZ14705LS3	308

# A-Z search by code

## Recherche alpha-numerique par référence

Codice Code Réf.	Pag. Page	Codice Code Réf.	Pag. Page
LZ14705LSN	308	LZ14706WSN	308
LZ14705WE2	308	LZ14707DE2	314
LZ14705WE3	308	LZ14707DE3	314
LZ14705WEN	308	LZ14707DEN	314
LZ14705WL2	308	LZ14707DL2	314
LZ14705WL3	308	LZ14707DL3	314
LZ14705WLN	308	LZ14707DLN	314
LZ14705WM2	308	LZ14707DM2	314
LZ14705WM3	308	LZ14707DM3	314
LZ14705WMN	308	LZ14707DMN	314
LZ14705WS2	308	LZ14707DS2	314
LZ14705WS3	308	LZ14707DS3	314
LZ14705WSN	308	LZ14707DSN	314
LZ14706DE2	308	LZ14707KE2	314
LZ14706DE3	308	LZ14707KE3	314
LZ14706DEN	308	LZ14707KEN	314
LZ14706DL2	308	LZ14707KL2	314
LZ14706DL3	308	LZ14707KL3	314
LZ14706DLN	308	LZ14707KLN	314
LZ14706DM2	308	LZ14707KM2	314
LZ14706DM3	308	LZ14707KM3	314
LZ14706DMN	308	LZ14707KMN	314
LZ14706DS2	308	LZ14707KS2	314
LZ14706DS3	308	LZ14707KS3	314
LZ14706DSN	308	LZ14707KSN	314
LZ14706KE2	308	LZ14707LE2	314
LZ14706KE3	308	LZ14707LE3	314
LZ14706KEN	308	LZ14707LEN	314
LZ14706KL2	308	LZ14707LL2	314
LZ14706KL3	308	LZ14707LL3	314
LZ14706KLN	308	LZ14707LLN	314
LZ14706KM2	308	LZ14707LM2	314
LZ14706KM3	308	LZ14707LM3	314
LZ14706KMN	308	LZ14707LMN	314
LZ14706KS2	308	LZ14707LS2	314
LZ14706KS3	308	LZ14707LS3	314
LZ14706KSN	308	LZ14707LSN	314
LZ14706LE2	308	LZ14707WE2	314
LZ14706LE3	308	LZ14707WE3	314
LZ14706LEN	308	LZ14707WEN	314
LZ14706LL2	308	LZ14707WL2	314
LZ14706LL3	308	LZ14707WL3	314
LZ14706LLN	308	LZ14707WLN	314
LZ14706LM2	308	LZ14707WM2	314
LZ14706LM3	308	LZ14707WM3	314
LZ14706LMN	308	LZ14707WMN	314
LZ14706LS2	308	LZ14707WS2	314
LZ14706LS3	308	LZ14707WS3	314
LZ14706LSN	308	LZ14707WSN	314
LZ14706WE2	308		
LZ14706WE3	308		
LZ14706WEN	308		
LZ14706WL2	308		
LZ14706WL3	308		
LZ14706WLN	308		
LZ14706WM2	308		
LZ14706WM3	308		
LZ14706WMN	308		
LZ14706WS2	308		
LZ14706WS3	308		



# Italia

Via Pizzigoni, 3  
24060 Villongo (BG)  
tel. 035-939411  
fax 035-939496  
e-mail: info@lombardo.it  
www.lombardo.it

## LOMBARDIA – PIACENZA

AGENZIA BIEFFE  
Via Mazzini, 70/s  
20026 Trezzo s/Adda (MI)  
Tel. 02 90963740  
Fax. 02/90964607  
e-mail: info@agenziabieffe.com  
www.agenziabieffe.com

## LIGURIA

CHIESTA GIACOMO DI GUIDO STEFANO & C. SAS  
Via Villa Berrone 31/33 R  
16014 Campomorone (GE)  
Tel. 010 780 152 - 010 783 732  
Fax. 010 780 318  
e-mail: agenziachiesta@agenziachiesta.com

## PIEMONTE, VALLE D'AOSTA

AGENZIA BM SRL  
Via Mascagni, 20/B  
10040 Rivalta Di Torino (TO)  
Tel. 011 349 5521  
e-mail: info@agenziabm.it

## EMILIA ROMAGNA

GIAN LUCA BONAFINI  
Via Don Angelo Bughetti, 14  
40026 Imola (BO)  
Telefono 0542 190 4002  
Cell. Sig. Gianluca Bonafini: 335 586 6286  
e-mail: bonafini@agenziabonafini.it

## VENETO

(PADOVA-VICENZA-ROVIGO-VENEZIA)  
SITEL SRL (sede)  
Via Lisbona, 28/A  
35127 Padova  
Tel. 049 760999  
e-mail: info@sitelx.it

## AGENZIA AEB

Via Porretana, 148/3  
40135 Bologna (BO)  
Tel. 347 012 2539  
Cell. Sig. Fabio Ferrari: 348 710 7947  
e-mail: agenziaaeb@agenziaaeb.it

## VERONA - TRENTINO ALTO ADIGE

SITEL SRL (filiale)  
Via Spagnole, 2/B  
37015 Santambrogio di Valpolicella (VR)  
Tel. 049 760999  
e-mail: info@sitelx.it

## TOSCANA , UMBRIA

LIBRA S.R.L.  
Via Crispi, 34  
55041 Lido di Camaiore (LU)  
Tel. 0584 617 802  
Fax 0584 618 494  
e-mail: luporini@tin.it

## TREVISO - BELLUNO - FRIULI VENEZIA GIULIA

SITEL SRL (filiale)  
Via Don Pietro della Toffola, 24  
33074 Fontanafredda (PN)  
Tel. 049 760999  
e-mail: info@sitelx.it

## MARCHE

GIAMPAOLI LUCA  
Via Olimpia, 6  
62016 Porto Potenza Picena (MC)  
Tel. e Fax 0733-687256  
Cell. Sig. Luca Giampaoli: 337 638 017  
e-mail: giampaoli1992@gmail.com  
Cell. Sig. Luciano Tirabassi: 337 660 826  
e-mail: tirabassi.luciano@gmail.com  
Cell. Sig. Marco Di Marco: 335 104 8969  
e-mail: dimarco.ma@gmail.com



**ABRUZZO – MOLISE**

MASTROMAURO FRANCESCA  
Via Raiale, 159  
65128 Pescara  
Tel. 085 431 0996  
Fax 085 430 9458  
e-mail: info@agenziamastromauro.it

**CALABRIA**

GERVASI GIAMPAOLO RAPPRESENTANZE  
Sede Legale:  
Via Dell'accoglienza, 21/C - 87040 Mendicino (CS)  
Sede Operativa:  
Via Giovanni XXIII, 44 - 88021 Borgia (CZ)  
Tel./Fax: 0961951065  
e-mail uffici: g.gervasirappresentanze@gmail.com

**LAZIO**

SR RAPPRESENTANZE S.N.C. di Anastasi R.  
e Pandolfi S. & C.  
Via del Casale Ferranti, 85 - 00178 Roma  
Tel. 06 87165024  
Cell. Sig. Anastasi Roberto: 335 5241662  
Cell. Sig. Bracale Marco: 392 3210449  
Cell. Sig. Pandolfi Stefano: 335 6497659  
e-mail: commerciale@sprappresentanze.com

**SICILIA**

FIORE RAPPRESENTANZE S.N.C.  
Via Aspromonte, 57  
90144 Palermo  
Tel. 091 626 9961  
Fax 091 626 9953  
Cell. Sig. Matteo Fiore 337 891 214  
Cell. Sig. Mario Galvagna 337 500 036  
e-mail: fioreagenziapa@gmail.com

**CAMPANIA**

PROJECT LIGHTING STUDIO S.A.S.  
Via Kennedy, 107  
80010 Quarto (NA)  
Tel. 081-19483273  
Cell. Marzocchella Sergio: 393 337 0004  
Cell. Marzocchella Maurizio: 339 172 9190  
e-mail: mmarzocchella@gmail.com/  
smarzocchella@gmail.com

**SARDEGNA**

MAKELUCE di Paola Sias  
Via Giotto, 40  
09121 Cagliari  
Tel. 070 541 116  
Cell. Sig.ra Paola Sias: 348 432 6489  
e-mail: paolasias@makeluce.it  
Cell. Sig. Bruno Sias: 348 603 6488  
e-mail: bruno.sias@tin.it

**PUGLIA – BASILICATA**

GRIMALDI FRANCESCO  
Via Vigili del Fuoco Caduti in Servizio, 51  
70026 Modugno (BA)  
Tel. 080 502 2650  
Fax 080 502 1684  
e-mail: agenzigrimaldi@agenziagrimaldi.it  
www.agenziagrimaldi.it

## Export

---

Tel. +39 035-939411  
export@lombardo.it

## Note generali *General note - Notes générales*

### ITA

#### **Direttiva RAEE: Rifiuti di apparecchiature elettriche ed elettroniche**

Il 25 Luglio 2005 il Consiglio di ministri ha recepito con Decreto Legislativo N°151 la Direttiva Europea 2002/96/CE relativa alla riduzione delle sostanze pericolose nelle apparecchiature elettriche ed elettroniche e dello smaltimento dei rifiuti da essi derivanti. L'obiettivo è promuovere una logica di sviluppo sostenibile nel settore delle apparecchiature elettriche ed elettroniche, di cui gli apparecchi di illuminazione ne fanno parte, ai fini di un corretto trattamento dei prodotti a fine vita e ciò può attuarsi attraverso la piena conformità alla Direttiva RAEE.

Il Produttore, come definito dal Dlgs n°151, dovrà farsi carico dei costi di gestione che comprendono la raccolta, presso gli impianti di stoccaggio provvisorio e dello smaltimento dei rifiuti degli apparecchi di illuminazione immessi sul mercato.

Per adempiere a questi obblighi di legge Lombardo S.r.l. ha deciso di avvalersi del Consorzio ECOLIGHT.

Gli apparecchi di illuminazione saranno marcati in modo da identificare il Produttore e riportare il simbolo del cassonetto barrato, indicante la raccolta differenziata separata dal resto dei rifiuti urbani.

Gli apparecchi illuminanti all'interno del presente listino/catalogo, con esclusione degli accessori, saranno soggetti al contributo di smaltimento in base al loro peso netto e si suddividono in tre fasce:

Fascia 1:

Apparecchi il cui peso è compreso tra 0 e 2 Kg.

Fascia 2:

Apparecchi il cui peso è compreso tra 2 e 8 Kg.

Fascia 3:

Apparecchi il cui peso è superiore a 8 Kg.

#### **Direttiva RoHS**

Il Decreto Legislativo sopra menzionato incorpora anche la Direttiva 2002/95/CE - RoHS - Limiti d'uso di alcune sostanze pericolose - relativa alla riduzione delle sostanze pericolose nelle apparecchiature elettriche ed elettroniche. A partire dal 1° Luglio 2006 tutte le nuove apparecchiature elettriche ed elettroniche immesse sul mercato non dovranno contenere o contenere in misura limitata sostanze quali: Piombo - Mercurio - Cadmio - Cromo esavalente - Bifenile polibromurati (PBB) - Eteri difendi polibromurati (PBDE).

#### **Informativa art.13 D.lgs 196/2003**

Gentile Signore/a, ai sensi del D.Lgs 196/2003 sulla tutela delle persone e di altri soggetti rispetto al trattamento dei dati personali, il trattamento delle informazioni che La riguardano, sarà improntato ai principi di correttezza, liceità e trasparenza e tutelando la Sua riservatezza ed i Suoi diritti. I dati sono conservati nel data base informatico (o cartaceo) del titolare del trattamento LOMBARDO S.r.l. I dati raccolti, provengono esclusivamente da elenchi e/o registri pubblici, e saranno trattati anche da incaricati interni della struttura, preposti alla gestione dell'iniziativa per l'invio del materiale commerciale e promozionale.

Il titolare del trattamento è LOMBARDO S.r.l. -

Via Pizzigoni, 3 - 24060 Villongo (Bg); il Responsabile della Sicurezza è il Sig. Lussana Claudio.

Potrà esercitare i diritti di cui all'art. 7 del

D.Lgs 196/03 (accesso, integrazione, modifica, cancellazione) telefonando al Responsabile del Trattamento al numero 035/939411, a mezzo posta elettronica all'indirizzo [amministrazione@lombardo.it](mailto:amministrazione@lombardo.it) oppure scrivendo a LOMBARDO S.r.l. - ufficio privacy - Via Pizzigoni, 3 - 24060 Villongo (Bg).

### ENG

*As responsible manufacturer with specific concern for the protection of the environment Lombardo is proud to be a member of "Ecolight" Electrical Waste Disposal and Recycling scheme in Italy.*

*Take care to ensure you meet your own environmental obligations in your own country.*

### FRA

*LOMBARDO adhère au consortium ECOLIGHT  
Via Gattamelata 34,  
20149 Milano Tel. 02 3264816*

**LOMBARDO**



**aderisce al consorzio**

**ECO LIGHT**

ECOLIGHT

Via Gattamelata 34,  
20149 Milano Tel. 02 3264816



## Note generali General note - Notes générales

### ITA

Tutti i dati contenuti nel presente catalogo sono validi a condizione che gli apparecchi siano installati ed utilizzati nel modo per cui sono stati costruiti e che venga fatta correttamente manutenzione. Il tutto nel rispetto delle regole professionali, dello standard di installazione e delle istruzioni del produttore. Tutti gli apparecchi sono testati secondo le norme EN60598-1. La LOMBARDO S.r.l. non si assume responsabilità per impieghi diversi da quelli testati e per la mancata osservanza delle indicazioni riportate sul foglio istruzioni.

### IMPORTANTI

Gli apparecchi intesi per uso continuato o per periodi protratti devono essere soggetti a discussione con il ns. Ufficio Tecnico. I prodotti LOMBARDO, come pubblicati in catalogo, sono stati disegnati, studiati e testati per il corretto funzionamento in base alle sorgenti luminose come indicato in catalogo accanto ad ogni articolo. Rammentiamo quindi alla Spett.le Clientela che qualora l'utente intenda utilizzare i ns. prodotti con tipi di lampadine diversi da quelli pubblicati, la LOMBARDO S.r.l. non si assume alcuna responsabilità. Gli apparecchi ad incandescenza sono per tensione nominale fino a 250V. Gli apparecchi a fluorescenza sono per tensione nominale 230V 50Hz. Tutti gli apparecchi sono forniti senza lampadine.

### Condizioni di vendita

I prodotti illustrati nel presente listino sono destinati esclusivamente al mercato italiano.

### Resa merce

Per ordini di importo superiore a 600,00 netto, la resa verrà effettuata in porto franco. Per ordini di importo inferiore a 600,00 netto, la resa verrà effettuata franco destino con addebito del costo del trasporto in fattura.

### Reclami

I reclami inerenti all'integrità del materiale dovranno essere fatti al trasportatore nel momento della consegna della merce, firmando il documento di trasporto con riserva. I reclami inerenti la quantità del materiale verranno da noi accettati nel termine massimo di 8 (otto) giorni dal ricevimento della merce.

### Ordini minimi

Non si accettano ordini inferiori a 300,00 netti.

### Dimensioni

Le quote nel listino si intendono in millimetri.

### Imballi

Si prega la Spettabile Clientela di attenersi agli imballi standard esposti in listino.

### Resi

Non si accettano resi. Situazioni eccezionali verranno come tali trattate dalla Direzione Commerciale.

### Listino valido fino a revoca

### Modifiche dei prodotti

LOMBARDO S.r.l. si riserva il diritto di apportare ai propri prodotti, in qualunque momento e senza alcun preavviso, tutte le modifiche che, a suo insindacabile giudizio, riterrà convenienti ai fini produttivi o utili a migliorare la funzionalità e le prestazioni. Errori ed omissioni sono accettati.

### ENG

All the data in this catalogue is valid providing the luminaires are installed, maintained and used in the way for which they were made, using "professional practice", relevant installation standards and manufacturers instructions. All luminaires in this catalogue have been tested according to EN60598-1. LOMBARDO S.r.l. will not accept responsibility for uses other than the tested ones, or for a non-observance of the instructions mentioned in our instruction leaflet.

### IMPORTANT!

Where a luminaire is to be used for hazardous, continuous or extended burning hours please contact our Technical Department for confirmation of the suitability of the item chosen. The LOMBARDO range of products in our catalogue have been designed, engineered and tested to function correctly with the light source specified alongside each product. Where a customer installs a light source other than the one specified or converts our luminaires in any way, LOMBARDO S.r.l. can not accept responsibility for failures or incidents that result from the changes made. If in doubt please contact our Technical Department.

Nominal voltage of incandescent luminaires: up to 250V

Nominal voltage of fluorescent luminaires: 230V 50Hz

Luminaires are supplied without lamps.

We reserve the right to alter and modify specifications.

Errors and omissions accepted.

### FRA

Toutes les données présentes dans ce catalogue sont valables à condition que les appareils soient installés et utilisés selon les modalités pour lesquelles ils ont été fabriqués et soient correctement entretenus dans le respect des règles professionnelles, des spécifications d'installation et des instructions du fabricant. Tous les appareils sont testés selon les normes EN60598-1. LOMBARDO S.r.l. décline toute responsabilité pour des emplois différents de ceux qui ont été testés et en cas de non-respect des indications fournies par le feuillet d'instructions.

### IMPORTANT

Les appareils prévus pour un emploi suivi ou des périodes prolongées doivent être soumis à l'examen de notre Bureau d'Étude. Les produits LOMBARDO publiés au catalogue ont été conçus, étudiés et testés pour fonctionner correctement avec les sources lumineuses indiquées à côté de chaque article. Nous rappelons donc que LOMBARDO S.r.l. décline toute responsabilité pour l'utilisation de nos produits avec des ampoules différentes de celles qui sont préconisées.

Les appareils à incandescence sont destinés à une tension nominale de 250V.

Les appareils à fluorescence sont destinés à une tension nominale de 230V 50Hz.

Tous les appareils sont fournis sans ampoules

### MODIFICATIONS DES PRODUITS

Lombardo S.r.l. se réserve la faculté d'apporter à ses produits, à tout moment et sans préavis, toutes les modifications qui, selon son avis discrétionnaire, se rendraient nécessaires pour des fins liées à la production ou s'avèreraient utiles pour améliorer leur fonctionnalité et leur efficacité. Sous réserve d'erreurs ou omissions.

## Condizioni di garanzia

ITA

### Condizioni di garanzia offerte da Lombardo S.r.l. per la fornitura di prodotti che utilizzano la sorgente luminosa a LED.

L'elevato standard qualitativo dei prodotti Lombardo consente alla società di offrire una garanzia integrale in caso di uso conforme della durata di cinque (5) anni e/o 50.000h di funzionamento.

#### 1) PRODOTTI

La presente garanzia si applica ai prodotti **LOMBARDO che utilizzano una sorgente luminosa a LED**, limitatamente alla sorgente LED.

La presente Garanzia copre gli apparecchi utilizzati in ambienti con temperature non superiori a 25° C Ta.

#### 2) CONDIZIONI DELLA GARANZIA

La presente garanzia ha efficacia esclusivamente a condizione che:

- 1) l'utente utilizzi il prodotto Lombardo secondo le specifiche del prodotto stesso;
- 2) il prodotto sia stato installato correttamente da personale tecnico qualificato in possesso dei requisiti previsti dalle normative rispettivamente applicabili;
- 3) le apparecchiature non siano state modificate dall'utente e/o non siano state eseguite manutenzioni/riparazioni senza l'autorizzazione scritta da parte dell'ufficio tecnico di Lombardo.

#### Ulteriori condizioni

- I prodotti difettosi dovranno essere inviati a Lombardo entro 15 giorni dalla scoperta del malfunzionamento, a pena di decadenza della presente garanzia, e i costi di tale spedizione saranno a carico del cliente. I costi di smontaggio e rimontaggio sono a carico del cliente. Eventuali costi sostenuti per accedere al luogo di installazione (es: trabattelli, elevatori, apertura degli spazi in orari notturni, intervento di terze parti) sono a carico del cliente.

#### 3) DURATA DELLA GARANZIA e LIMITAZIONI

- La garanzia concessa dalla Lombardo S.r.l. al CLIENTE per i **prodotti Lombardo che utilizzano una sorgente luminosa a LED**, ha la durata di cinque (5) anni e/o 50.000h di funzionamento, mentre per i driver la garanzia ha una durata di 2 anni dalla data di acquisto.
- Per assicurare che la garanzia del prodotto coincida con la garanzia del produttore, la garanzia viene estesa di ulteriori 3 mesi dalla data di produzione riportata sul prodotto, fino ad un massimo di 63 mesi dalla data di produzione. Tale data è facilmente identificabile sull'etichetta del prodotto.

#### 4) ESCLUSIONI

La garanzia non copre

- danni causati dal trasporto;
- danni causati dall'utilizzo dell'apparecchiatura in condizioni ambientali inadeguate;
- danni causati da negligenza o da carenze manutentive o tentativi di riparazione eseguiti da personale non qualificato e/o non autorizzato e comunque con l'utilizzo di accessori o pezzi di ricambio non originali;
- apparecchi installati su impianti che hanno uno squilibrio (tensione/corrente) del fattore di potenza inferiore a 0,8;
- apparecchi installati su impianti privi di sistemi di protezione contro sovratensioni di qualsiasi natura (es.: fulmini).

#### 5) ESECUZIONE DELLA GARANZIA

- La garanzia convenzionale qui prevista potrà operare esclusivamente nel caso in cui la stessa costituisca oggetto di reclamo scritto alla Lombardo S.r.l., da inviarsi, mediante lettera o e-mail, entro **quindici (15) giorni** dal manifestarsi del cattivo funzionamento dell'apparato, a pena di decadenza.
- Il **CLIENTE**, per avvalersi della garanzia convenzionale qui rilasciata, dovrà fornire la prova di aver rispettato le condizioni di cui sopra.

**La difettosità degli apparecchi verrà valutata dalla Lombardo S.r.l. che a suo insindacabile giudizio determinerà se questa rientra nelle condizioni di garanzie qui esposte.**

- L'utente che si avvarrà della garanzia avrà diritto alla sostituzione o riparazione dell'apparecchio.
- A seguito del progresso tecnologico nonché delle modifiche verificatesi nell'uso del flusso luminoso di prodotti, i moduli LED inviati in sostituzione potrebbero differire nelle caratteristiche di illuminazione rispetto ai prodotti originali.
- Lombardo S.r.l. si riserva il diritto di sostituire il prodotto difettoso con altro prodotto simile nel design avente performance uguali o superiori, o di rifondere il cliente per l'importo acquistato.
- Sono esclusi i costi di manodopera per la sostituzione degli apparecchi e comunque ogni danno, sia pure indirettamente, connesso con la difettosità dell'apparecchio.
- Nessun agente, distributore o rivenditore è in alcun modo autorizzato a cambiare, modificare o estendere i termini della garanzia per conto della Lombardo S.r.l. in qualsiasi condizione.
- Su richiesta della Lombardo S.r.l. i prodotti non conformi o difettosi diventeranno di proprietà della Lombardo S.r.l. non appena saranno sostituiti.

#### 6) LEGGE APPLICABILE - FORO COMPETENTE

L'esecuzione, interpretazione e tutte le questioni pertinenti la validità e gli effetti della presente garanzia convenzionale saranno comunque determinate e regolate dalla legge italiana. Ogni e qualsiasi controversia comunque derivante dalla presente garanzia o ad essa connessa e/o relativa sarà devoluta alla competenza esclusiva del Foro di Bergamo.

Ai sensi e per gli effetti degli art.1341 e 1342 del codice civile si approvano specificatamente le clausole di cui agli articoli: 2 (condizioni della garanzia), 3 (durata della garanzia e limitazioni), 4 (esclusioni). 5 (esecuzione della garanzia) e 6 (legge applicabile - foro competente)





Terms of guarantee

ENG

**Terms of guarantee offered by Lombardo S.r.l. for the supply of products using a LED light source.**

The high level of quality of the Lombardo products enables the company to offer a complete guarantee **lasting five (5) years and/or 50,000 operating hours** for the standard use of its products..

**1) PRODUCTS**

This guarantee applies to **LOMBARDO products using a LED light source**, and is limited to the LED source.

This Guarantee covers light fittings used in environments with a maximum environmental temperature of 25°C.

**2) TERMS OF THE GUARANTEE**

This guarantee is valid only on condition that:

- 1) the user uses the Lombardo product according to the specifications of the product itself;
- 2) the product is installed correctly by qualified technicians with the qualifications required by the applicable regulations;
- 3) the light fittings are not modified by the user and/or that maintenance/repairs have not been carried out without the written authorisation of the Lombardo technical office.

**Further conditions**

- Faulty products must be sent to Lombardo within 15 days from the discovery of the fault otherwise this guarantee will be null and void. The costs of transport will be at the customer's expense. The costs of disassembling and reassembling the product are at the customer's expense. Any costs incurred for gaining access to the place of installation (e.g. mobile scaffolding, hoists, opening of places at night, intervention of third parties) will be at the customer's expense.

**3) DURATION OF THE GUARANTEE and LIMITATIONS**

- The guarantee granted by Lombardo S.r.l. to the CUSTOMER for **Lombardo products using a LED light source**, lasts for five (5) years and/or 50,000 operating hours, while for the driver the guarantee period is two (2) years from the date of purchase.
- To ensure that the product guarantee coincides with the manufacturer's guarantee, the guarantee is extended for a further 3 months from the date of manufacture printed on the product, up to a maximum of 63 months from the date of manufacture. This date is easy to identify on the product label.

**4) EXCLUSIONS**

The guarantee does not cover

- damage caused by transport;
- damage caused by using the light fitting in unsuitable environmental conditions;
- damage caused by negligence or a lack of maintenance or attempts at repair work carried out by unqualified and/or unauthorised personnel and in any case without using the original accessories or spare parts;
- fittings installed on wiring systems that have a power factor unbalance (voltage/current) of less than 0.8;
- fittings installed on wiring systems without any type of overvoltage protection (e.g. for lightning).

**5) FULFILMENT OF THE GUARANTEE**

- The conventional guarantee provided herein can only be fulfilled if it is the subject of a written claim to Lombardo S.r.l. to be sent by means of letter or e-mail within **fifteen (15) days** from the discovery of the faulty operation of the fitting, otherwise the guarantee will be null and void.
- In order to take advantage of the conventional guarantee issued herewith, **THE CUSTOMER** must provide proof of having followed the afore-mentioned conditions.

**The faultiness of the light fittings will be assessed by Lombardo S.r.l. which will determine, at its own irrevocable decision, whether it falls within the guarantee conditions described herein.**

- The user benefiting from the guarantee will have the right to have the light fitting replaced or repaired.
- Following technological progress as well as modifications that may take place in the use of the products' light flow, the lighting characteristics of the LED modules sent to replace the faulty ones may differ compared with the original products.
- Lombardo S.r.l. reserves the right to replace the faulty product with another product similar in design offering a similar or better performance or it may reimburse the customer for the amount paid.
- The cost of labour for the replacement of the light fitting and, in any case, for any damage even if indirect connected with the faultiness of the product, is excluded.
- No agent, distributor or retailer is in any way authorised to change, modify or extend the terms of the guarantee on behalf of Lombardo S.r.l., under any circumstance.
- At the request of Lombardo S.r.l. the non-conforming or faulty products will become the property of Lombardo S.r.l. as soon as they have been replaced.

**6) GOVERNING LAW - COMPETENT COURT OF LAW**

The fulfilment, interpretation and any questions linked to the validity and effects of this conventional guarantee will, in all cases, be determined and governed by the Italian law. Any controversy that may arise from this guarantee or is connected with it and/or related to it will be transferred to the exclusive competence of the court of Bergamo.

For the effects and purposes of articles 1341 and 1342 of the civil code, specific approval is given of the clauses stated in articles: 2 (terms of the guarantee), 3 (duration of the guarantee and limitations), 4 (exclusions), 5 (fulfilment of the guarantee) and 6 (governing law – competent court of law).

FRA

## Conditions de garantie offertes par Lombardo S.r.l. pour la fourniture de produits qui utilisent la source lumineuse LED

Le haut standard de qualité des produits Lombardo permet à la société d'offrir une garantie intégrale, en cas d'emploi correct, **de la durée de cinq (5) ans et/ou 50.000 h** de fonctionnement.

### 1) PRODUITS

La présente garantie s'applique aux produits LOMBARDO qui utilisent la source lumineuse LED, et uniquement pour ce qui concerne la source LED.

La présente garantie couvre les appareils utilisés dans des milieux dont la température ne dépasse pas 25° C Ta.

### 2) CONDITIONS DE LA GARANTIE

La présente garantie est uniquement valable à condition que:

- 1) l'utilisateur utilise le produit LOMBARDO conformément aux spécifications dudit produit;
- 2) le produit ait été correctement installé par un personnel technique qualifié ayant les compétences requises par les normes respectivement applicables;
- 3) les appareils n'aient pas été modifiés par l'utilisateur et/ou n'aient pas subi d'interventions de maintenance/réparations sans l'autorisation écrite du bureau technique de Lombardo.

### Autres conditions

- Les produits défectueux devront être envoyés à Lombardo sous 15 jours à compter de la découverte du problème de fonctionnement, sous peine de nullité de la présente garantie, et les frais de cette expédition seront à la charge du client.

Les frais de démontage et remontage sont à la charge du client. Les frais éventuellement encourus pour accéder au lieu d'installation (ex : échafaudages roulants, élévateurs, ouverture des espaces en horaires nocturnes, intervention de tierces parties) sont à la charge du client.

### 3) DURÉE DE LA GARANTIE ET LIMITATIONS

- La garantie accordée par Lombardo S.r.l. au CLIENT, pour les produits Lombardo qui utilisent la source lumineuse LED, a une durée de cinq (5) ans et/ou 50.000 h de fonctionnement, tandis que pour le driver la période de garantie est de deux (2) ans à compter de la date d'achat.
- Pour être certains que la garantie du produit coïncide avec la garantie du fabricant, la garantie est prolongée de 3 mois à compter de la date de fabrication indiquée sur le produit, jusqu'à un maximum de 63 mois à compter de la date de fabrication. Cette date est facile à identifier sur l'étiquette du produit.

### 4) EXCLUSIONS

La garantie ne couvre pas:

- les dommages causés par le transport;
- les dommages causés par l'utilisation de l'appareil dans des conditions ambiantes inadéquates;
- les dommages causés par la négligence, un manque d'entretien ou des tentatives de réparation effectuées par du personnel non qualifié et/ou non autorisé et dans tous les cas en utilisant des accessoires ou bien des pièces de rechange qui ne sont pas d'origine;
- les appareils montés sur des installations qui ont un déséquilibre (tension/courant) du facteur de puissance inférieur à 0,8;
- les appareils montés sur des installations sans systèmes de protection contre les surtensions, de quelque nature qu'elles soient (ex. : foudre).

### 5) EXECUTION DE LA GARANTIE

- La garantie conventionnelle prévue ici ne pourra être valable que dans le cas où elle sera l'objet d'une réclamation par écrit à Lombardo S.r.l., à envoyer, par lettre ou e-mail, au plus tard dans les quinze (15) jours qui suivent l'apparition du problème de fonctionnement de l'appareil, sous peine de nullité.
- Le CLIENT, pour faire valoir la garantie conventionnelle délivrée ici, devra fournir la preuve que les conditions susdites ont été respectées.

**Le défaut des appareils sera évalué par Lombardo S.r.l. qui, à sa discrétion exclusive, déterminera si celui-ci est couvert par les conditions de garantie exposées ici.**

- L'utilisateur qui fera valoir la garantie, aura droit au remplacement ou bien à la réparation de l'appareil.
- Suite au progrès technologique et aux modifications qui se sont vérifiées dans l'emploi du flux lumineux, les modules LED envoyés pour le remplacement pourraient être différents des caractéristiques d'éclairage des produits d'origine.
- Lombardo S.r.l. se réserve le droit de remplacer le produit défectueux par un autre produit avec un design similaire et des performances égales ou supérieures ou de rembourser au client le prix d'achat.
- La garantie ne couvre pas les frais de main d'œuvre pour le remplacement des appareils et, dans tous les cas, tout dommage lié, même indirectement, au défaut de l'appareil.
- Aucun agent, distributeur ou revendeur n'est autorisé à changer, modifier ou étendre les termes de la garantie pour le compte de Lombardo S.r.l., quelle que soit la condition.
- Sur demande de Lombardo S.r.l., les produits non conformes ou défectueux deviendront la propriété de Lombardo S.r.l. dès qu'ils seront remplacés.

### 6) LOI APPLICABLE – JURIDICTION COMPÉTENTE

L'exécution, l'interprétation et toutes les questions liées à la validité et aux effets de la présente garantie conventionnelle seront déterminées et régies par la loi italienne. Tout litige dérivant de la présente garantie ou qui y est lié relèvera exclusivement de la compétence du Tribunal de BERGAMO.

Aux termes et en exécution des articles art. 1341 et 1342 du code civil, les clauses des articles : 2 (conditions de la garantie), 3 (durée de la garantie et limitations), 4 (exclusions), 5 (exécution de la garantie) et 6 (loi applicable – juridiction compétente) sont expressément approuvées.

SAPOL - Material Eléctrico e Iluminação

SAPOL - Material Eléctrico e Iluminação

# LOMBARDO



Lombardo S.r.l.  
Via Pizzigoni 3  
24060 Villongo (BG), ITALY

**T** +39 035 939411  
**F** +39 035 939496  
info@lombardo.it

[lombardo.it](https://www.lombardo.it)

Copyright © 2022 - La riproduzione anche parziale è severamente vietata senza autorizzazione scritta da parte della Lombardo S.r.l.  
Total or even partial reproduction of this catalogue is forbidden without prior written authorization from Lombardo S.r.l.