

Systems of accessories for electrical installations used for residential, tertiary and industrial applications. The system consists of fasteners for pipes and cables, cable fittings, accessories for rigid pipes (RK Series) and flexible conduit (DF Series). The system include also a wide variety of cable ties (52FS Range) and terminal blocks (44 Range).

Cor	Cinza RAL 7035	Material	Polímero anti choques
Fixação	Em pressão	Para tubos Ø exterior (mm)	20
Glow Wire Test	750 °C	Distância parede - eixo do tubo (mm)	22
Temperatura de instalação	-5 +60 °C	Tipo de material	Libre halogéneos segundo EN 60754-2
Código Electrocod	21221	Norma	EN 61386-1 - EN 60670-1 (no que possa aplicar)

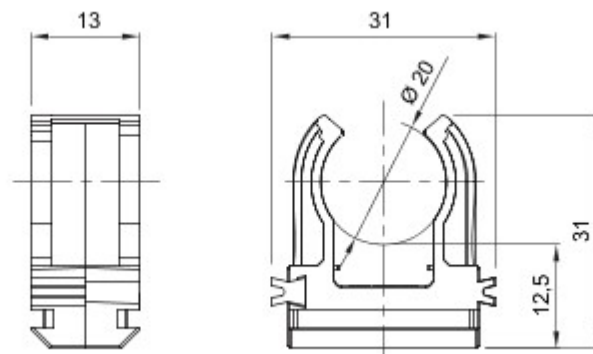

### DIMENSIONAL



### TECHNICAL SYMBOLOGY

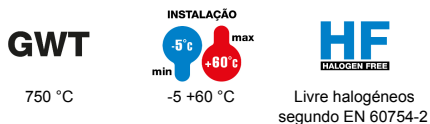

### STANDARDS/APPROVALS

GEWISS S.p.A. Via A. Volta, 1  
24069 Cenate Sotto - Bergamo - Italy  
tel. +39 035 94 61 11 fax +39 035 94 69 09

www.gewiss.com  
sat@gewiss.com  
Last update 23/01/2019

Data, measures, designs and pictures are shown only as informativ purposes, and could be changed without previous notice